

the catalogue

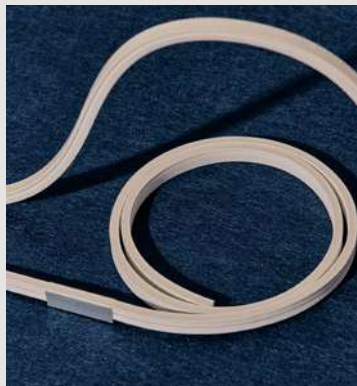

TECHNICAL & ARCHITECTURAL
LIGHTING

2026

LYOPRO

El poder de la luz

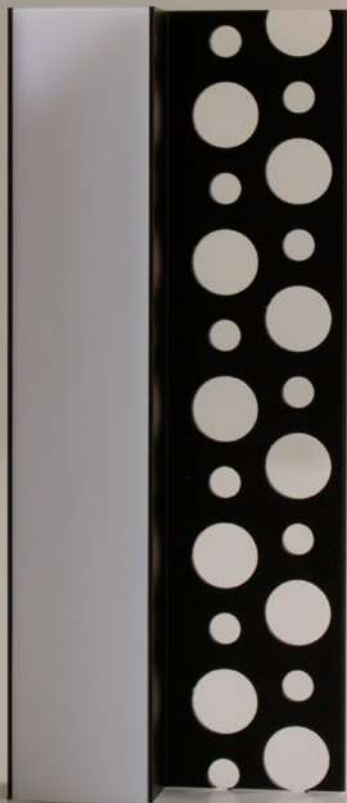

EN_ 'Playing with light is to give soul to each space, enhancing zones, corners and nuances. When light reveals its power, the space is transformed into a refuge, an inspiration or a unique place that drives every experience'.

FR_ « Jouer avec la lumière, c'est donner une âme à chaque espace, en mettant en valeur les zones, les coins et les nuances. Lorsque la lumière révèle son pouvoir, l'espace se transforme en un refuge, une source d'inspiration ou un lieu unique qui stimule chaque expérience ».

IT_ "Giocare con la luce significa dare anima a ogni spazio, valorizzando zone, angoli e sfumature. Quando la luce rivela il suo potere, lo spazio si trasforma in un rifugio, in un'ispirazione o in un luogo unico che guida ogni esperienza".

"Jugar con la luz es darle alma a cada espacio, potenciando zonas, rincones y matices. Cuando la luz revela su poder, el espacio se transforma en un refugio, una inspiración o un lugar único que impulsa cada experiencia."

La luz tiene el poder de transformar completamente un espacio, de darle carácter y propósito, de convertir lo ordinario en extraordinario. Con solo un toque de luz, un ambiente puede pasar de ser un rincón tranquilo a un punto de energía vibrante, o de una atmósfera fresca y funcional a una habitación cálida y acogedora.

El secreto está en jugar con la luz de manera creativa: ajustar su intensidad, dirección y color permite redefinir cualquier espacio según la necesidad y el estado de ánimo. Desde acentuar detalles arquitectónicos hasta crear ambientes envolventes, una iluminación adecuada convierte un lugar en una experiencia, demostrando que cada espacio tiene el potencial de transmitir una nueva perspectiva.

LYOPRO

Sobre nosotros

ES_ Somos una empresa joven con una gran trayectoria en el mundo de la iluminación LED. Nos apasiona transformar ambientes a través de la luz, ayudando a nuestros clientes a crear proyectos únicos con soluciones de alto rendimiento que combinan diseño, ahorro energético y durabilidad.

En Lyopro, nuestro éxito se basa en un conocimiento profundo de cada uno de nuestros productos de iluminación LED, desde la fabricación de cada diseño hasta su puesta en funcionamiento, abarcando tiras LED, perifería con sellado y luminarias de alta durabilidad. Nuestra experiencia nos ha permitido potenciar varios servicios clave: el departamento de proyectos que brinda asesoramiento técnico especializado, un servicio de corte a medida que se adapta a las necesidades específicas de cada cliente, y un amplio stock para garantizar disponibilidad inmediata.

EN_ We are a young company with a great track record in the world of LED lighting. We are passionate about transforming environments through light, helping our customers create unique projects with high-performance solutions that combine design, energy savings and durability.

At Lyopro, our success is based on an in-depth knowledge of each of our LED lighting products, from the manufacture of each design to its commissioning, encompassing LED strips, sealed profile and high durability luminaires. Our experience has allowed us to leverage several key services: a project department that provides specialised technical advice, a cut-to-size service that adapts to the specific needs of each customer, and a large stock to guarantee immediate availability.

FR_ Nous sommes une jeune entreprise avec une grande expérience dans le monde de l'éclairage LED. Nous sommes passionnés par la transformation des environnements par la lumière, en aidant nos clients à créer des projets uniques avec des solutions performantes qui allient design, économies d'énergie et durabilité.

Chez Lyopro, notre succès repose sur une connaissance approfondie de chacun de nos produits d'éclairage LED, de la fabrication de chaque conception à sa mise en service, en passant par les bandes LED, les profilés scellés et les luminaires à haute durabilité. Notre expérience nous a permis de mettre à profit plusieurs services clés : un département de projets qui fournit des conseils techniques spécialisés, un service de découpe sur mesure qui s'adapte aux besoins spécifiques de chaque client, et un stock important qui garantit une disponibilité immédiate.



“Creemos que quien concibe un producto desde su origen hasta su instalación final puede perfeccionarlo constantemente.”

IT_ Siamo un'azienda giovane con una grande esperienza nel mondo dell'illuminazione a LED. La nostra passione è trasformare gli ambienti attraverso la luce, aiutando i nostri clienti a creare progetti unici con soluzioni ad alte prestazioni che combinano design, risparmio energetico e durata.

In Lyopro, il nostro successo si basa su una conoscenza approfondita di ciascuno dei nostri prodotti per l'illuminazione a LED, dalla produzione di ogni progetto alla sua messa in funzione, che comprende strisce LED, profili sigillati e apparecchi di illuminazione ad alta durata. La nostra esperienza ci ha permesso di sfruttare diversi servizi chiave: un reparto progetti che fornisce consulenza tecnica specializzata, un servizio di taglio su misura che si adatta alle esigenze specifiche di ogni cliente e un ampio magazzino per garantire una disponibilità immediata.

LYOPRO TEAM

ES_ Nuestros departamentos trabajan de manera conjunta para ofrecer soluciones personalizadas y de calidad. Desde ventas hasta logística, cada equipo se enfoca en entender tus necesidades y proponer soluciones que combinan diseño y funcionalidad. Cada miembro de nuestro equipo colaborará estrechamente contigo para asegurar que cada detalle sea atendido y tu proyecto sea un éxito.

EN_ Our departments work together to provide personalized and high-quality solutions. From sales to logistics, each team focuses on understanding your needs and offering solutions that balance design and functionality. Every member of our team will work closely with you to ensure that every detail is addressed and your project is a success.

FR_ Nos départements travaillent ensemble pour offrir des solutions personnalisées et de qualité. De la vente à la logistique, chaque équipe se concentre sur la compréhension de vos besoins et propose des solutions alliant design et fonctionnalité. Chaque membre de notre équipe collaborera étroitement avec vous pour s'assurer que chaque détail soit pris en compte et que votre projet soit un succès.

IT_ I nostri dipartimenti lavorano insieme per offrire soluzioni personalizzate e di alta qualità. Dalle vendite alla logistica, ogni team si concentra sulla comprensione delle tue esigenze e propone soluzioni che combinano design e funzionalità. Ogni membro del nostro team collaborerà strettamente con te per garantire che ogni dettaglio venga curato e che il tuo progetto sia un successo.



info@lyopro.es



+ 34 961 181 138



lyopro.es



@lyopro.iluminacion

index

ENCUENTRA EL DISEÑO QUE MEJOR SE ADAPTA A TU ESPACIO

MINI DOWNLIGHTS EMPOTRAR / RECESSED MINI DOWNLIGHTS / MINI DOWNLIGHTS ENCASTRÉS / MINI DOWNLIGHTS INCASSO



DOWNLIGHTS EMPOTRAR / RECESSED DOWNLIGHTS / DOWNLIGHTS ENCASTRÉS / DOWNLIGHTS INCASSO

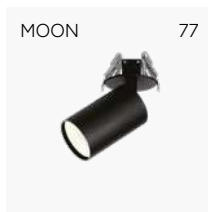

MINI DOWNLIGHTS SUPERFICIE / SURFACE MINI DOWNLIGHTS / MINI DOWNLIGHTS DE SURFACE / MINI DOWNLIGHTS DI SUPERFICIE



DOWNLIGHTS SUPERFICIE / SURFACE DOWNLIGHTS / DOWNLIGHTS DE SURFACE / DOWNLIGHTS DI SUPERFICIE

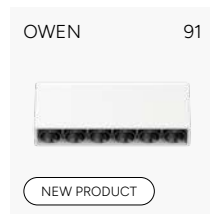
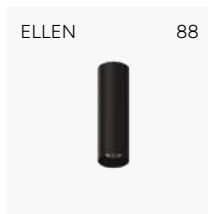

DOWNLIGHTS SUSPENSIÓN / PENDANT LUMINAIRES / DOWNLIGHTS Á SUSPENSION / APPARECCHIO A SOSPENSIONE

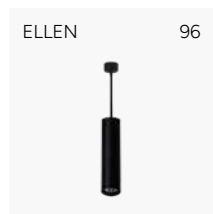

PLAFONES / LAMPS / LAMPES / LAMPADE



LINEAR LIGHT

OWEN 106-117



ORNA 119-121



LUMINARIAS ESCAYOLA / PLASTER LUMINAIRES / LUMINAIRES EN PLÂTRE / APPARECCHIO IN GESSO

LEK 124



LITAS 124



KIAT 126



WAT 127



DIRHAM 127



TAKA 128



YUAN 128



DONG 129



LUMINARIAS DE CARRIL / TRACK LUMINAIRES / LUMINAIRES SUR RAIL / PROIETTORE PER BINARIO

MOON 132



ARIES 133



TRACK SYSTEM

TRIFÁSICO 136

ACCESORIOS 136
-137TRIFÁSICO 138
DALIACCESORIOS 138
DALI -139

LUMINARIAS DE CARRIL 48V / 48V TRACK LUMINAIRES / LUMINAIRES SUR RAIL 48V / SISTEMA DI ILLUMINAZIONE A BINARIO 48V

CARRIL48V 142
-143ACCESORIOS 145
CARRIL

CORREA 48V 146

ACCESORIOS 149
CORREA

MINI PROYECTOR 152



PROYECTOR 153



PR. ZOOM 154



SEMIESFERA 156



FLEXIBLE 157



ESFERA 159



LINEAL 160



L. GRILLE 161



L. GRILLE TILT 162



ILUMINACIÓN INTERIOR EMPOTRADA / RECESSED INDOOR LIGHTING / ÉCLAIRAGE INTÉRIEUR ENCASTRÉ /
ILLUMINAZIONE INTERNA A INCASSO



APLIQUES INTERIOR / INDOOR APPLIANCES / APPAREILS D'INTÉRIEUR / INFISSI INTERNI

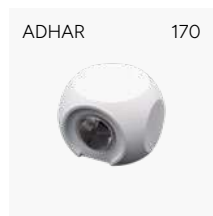

LUMINARIA LINEAL / LINEAR LUMINAIRES / LUMINAIRES LINÉAIRES / APPARECCHIO LINEARE



PANELES LED / LED PANELS / DALLES LED



ILUMINACIÓN INDUSTRIAL / INDUSTRIAL LIGHTING / ÉCLAIRAGE INDUSTRIEL / ILLUMINAZIONE INDUSTRIALE

DAPHNE 191



LUMINARIAS ESTANCAS / WATERPROOF LUMINAIRES / LUMINAIRES ÉTANCHES / PLAFONIERA STAGNA

BELA 195



ILUMINACIÓN DEPORTIVA Y GRANDES ÁREAS / SPORT LIGHTING & LARGE AREAS / ECLAIRAGE SPORTIF ET GRANDES SURFACES / ILLUMINAZIONE SPORTIVA E GRANDI AREE

NOVA 198

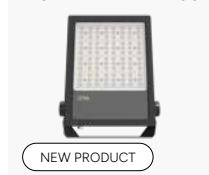

NEW PRODUCT

GOLDEN 199



ILUMINACIÓN EXTERIOR EMPOTRAR / OUTDOOR RECESSED LIGHTING / ÉCLAIRAGE ENCASTRÉ EXTÉRIEUR / ESTERNO ILLUMINAZIONE A INCASSO

PILEA 203



CIANA 204



HATRIA 207



ANAN 208
-209



ILUMINACIÓN EXTERIOR EMPOTRAR / *OUTDOOR RECESSED LIGHTING* / ÉCLAIRAGE ENCASTRÉ EXTÉRIEUR /
ESTERNO ILLUMINAZIONE A INCASSO

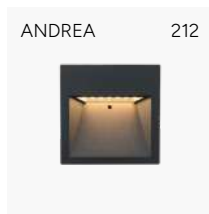

ILUMINACIÓN EXTERIOR SUPERFICIE / *OUTDOOR SURFACE LIGHTING* / ÉCLAIRAGE EXTÉRIEUR DE SURFACE /
ILLUMINAZIONE SUPERFICIE ESTERNO

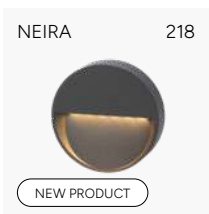

ILUMINACIÓN EXTERIOR SUPERFICIE / OUTDOOR SURFACE LIGHTING / ÉCLAIRAGE EXTÉRIEUR DE SURFACE / ILLUMINAZIONE SUPERFICIE ESTERNO

NILS 236



NEO 237



ROBER 238



NALIA 241



FLORA 243



ARIA 245



LEXIE 246



CARLOTA 247



ARNY 248



HANA 249



ILUMINACIÓN SUBACUÁTICA / UNDERWATER LIGHTING / ÉCLAIRAGE SOUS-MARIN / SOTT'ACQUA ILLUMINAZIONE

CAIA 252



ARALE 253



BOMBILLAS / LIGHT BULB / AMPOULE / LAMPADINA

GU-10 255



index

TIRAS LED / LED STRIPS / DES BANDES LED / STRISCE LED

INDOOR SERIES

2200K - 2700K - 3000K - 4000K - 6000K

IP20

24V

SANTORINI 260



4.8W

AUSTIN 261



7W

MIAMI 262



9.6W

BRISTOL 263



12W

OREGÓN 264



12W

CALIFORNIA 265



12W

MISURI 266



14.4W

ORLANDO 267

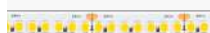

14.4W

DENVER 268



19.2W

DETROIT 269



24W

KANSAS 270



48W

RGB, RGB+W, RGB+CCT, TUNEABLE WHITE

IP20

24V

MADISON 271



12W

ALASKA 272



14.4W

DAYTON 273



15W

TORONTO 274



26.4W

RGB, RGB+W, RGB+CCT, TUNEABLE WHITE

IP20

24V

GEORGIA 275



19.2W

TIRA FLEXIBLE 3000K - 4000K

IP20

24V

MICHIGAN 277



14.4W

2700K - 3000K - 4000K - 6000K

IP20

48V

VANCOUVER 279



10W

OUTDOOR SERIES

2700K - 3000K - 4000K - 6000K

IP65-67

24V

SANTORINI 282



4.8W

MIAMI 283



9.6W

OREGÓN 284



12W

CALIFORNIA 285



12W

OUTDOOR SERIES

2700K - 3000K - 4000K - 6000K

IP65-67

24V

MISURI 286



14.4W

ORLANDO 287



14.4W

DENVER 288



19.2W

DETROIT 289



24W

RGB, RGB+W, RGB+CCT, TUNEABLE WHITE

IP65-67

24V

MADISON 290



12W

ALASKA 291



14.4W

DAYTON 292



15W

TORONTO 293



26.4W

GEORGIA 295



19.2W

FOOD SERIES

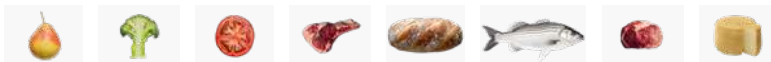

IP67

24V

DAKOTA 299



14.4W

2700K - 3000K - 4000K - 6000K

IP67

48V

VANCOUVER 301



10W

HIGH VOLTAGE

2200K - 2700K - 3000K - 4000K - 6000K

IP65-67

230V

TUCSON 304



10W

NELSON 305



14W

TEXAS 306



14W

DALLAS 308



15W

VEGAS 309



18W

RGB, COLORES INDIVIDUALES

IP65

230V

TEXAS 307



14W

MEMPHIS 311



15W

NEON FLEX SERIES

2200K - 2700K - 3000K - 4000K - 6000K

IP67

24V

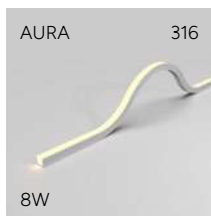

RGB, RGB+W, COLORES INDIVIDUALES

IP67

24V

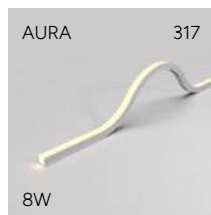

NEON FLEX 360°

IP67

24V



HIGH VOLTAGE NEON FLEX

2700K - 3000K - 4000K - 6000K

IP67

230V

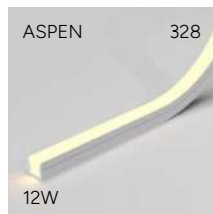

HIGH VOLTAGE NEON FLEX

COLOR INDIVIDUALES

IP67

230V

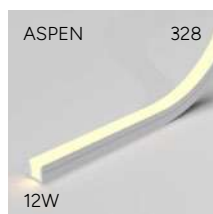

DIGITAL LIGHTING

RGB+WHITE 2700K - 3000K - 4000K, RGB

IP20

12V, 24V

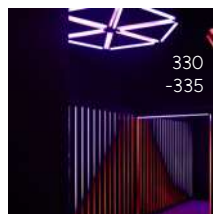

NEON FLEX AMBIENTES EXIGENTES

IP67-68

24V

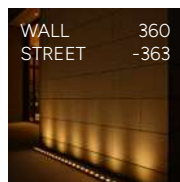
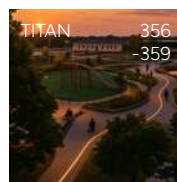
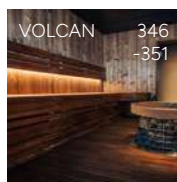
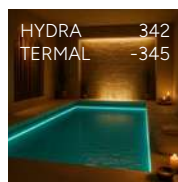
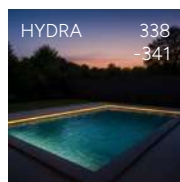

index

PERFILERÍA / PROFILE / PROFIL / PROFILI

PERFILES DE SUPERFICIE / SURFACE PROFILES / PROFILÉS DE SURFACE / PROFILI DI SUPERFICE

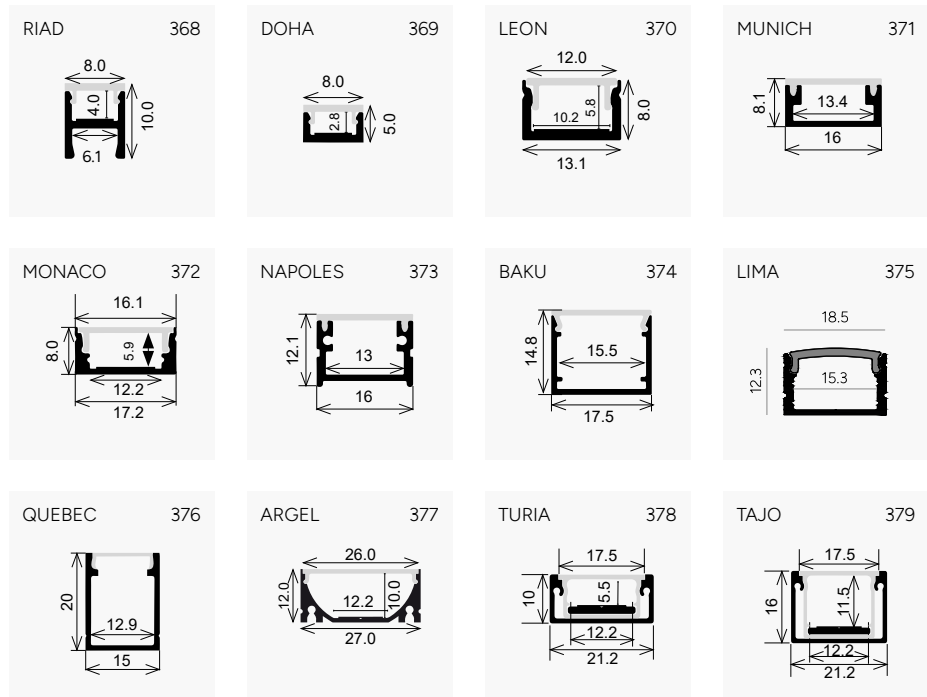

PLETINAS / PLATEN / PLATINE / PIASTRA A NASTRO



SUPERFICIE-SUSPENSIÓN / SURFACE-SUSPENSION / SOSPENSIONE-SUPERFICE

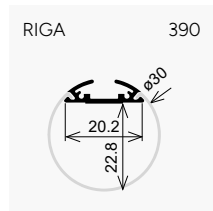
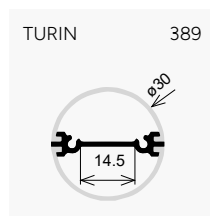
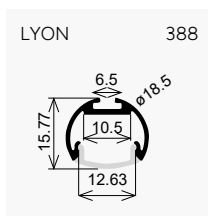
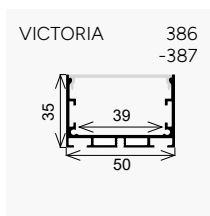
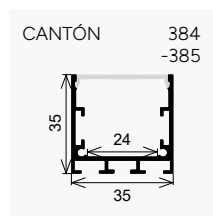

ANGULARES / ANGLE / D'ANGLE / ANGOLARI

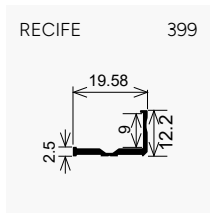
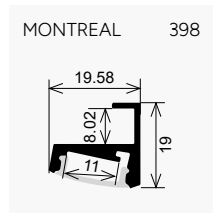
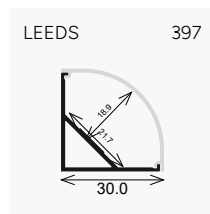
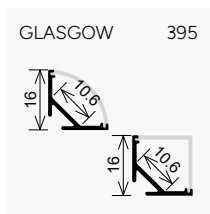

PERFILES DE EMPOTRAR / RECESSED PROFILES / PROFILÉS ENCASTRÉS / PROFILI DA INCASSO

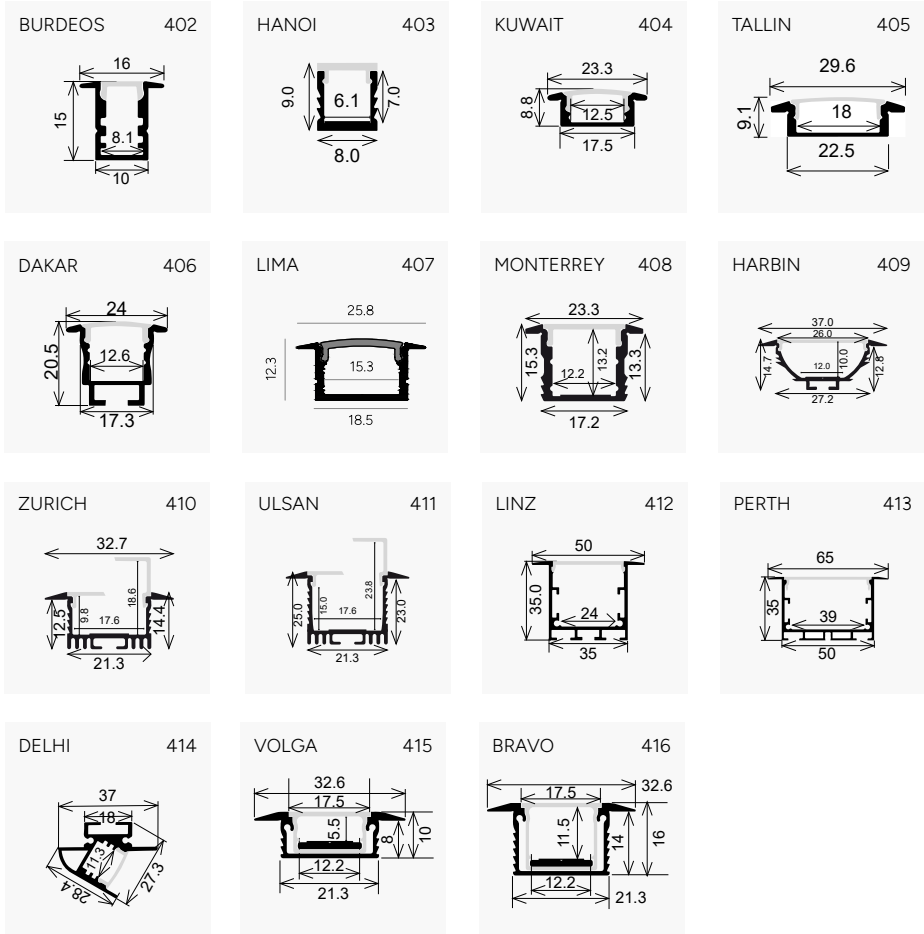

ARQUITECTÓNICOS / ARCHITECTUAL / ARCHITECTURAUX / ARCHITETTONICO

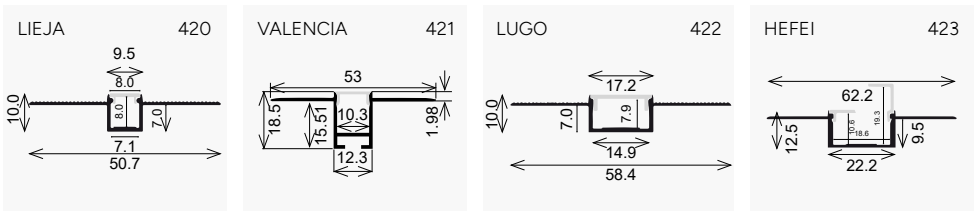

ARQUITECTÓNICOS / ARCHITECTUAL / ARCHITECTURAUX / ARCHITETTONICO

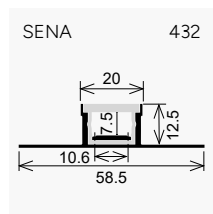
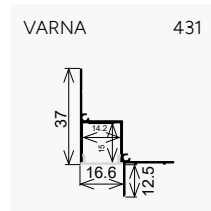
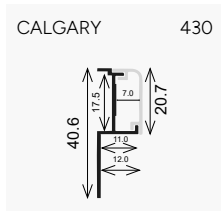
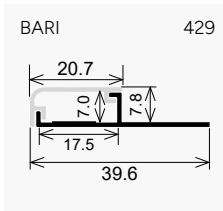
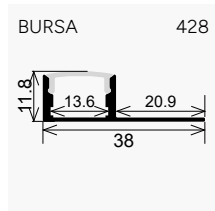
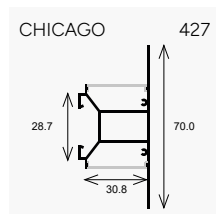
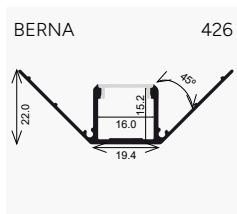
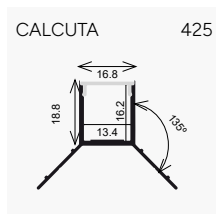
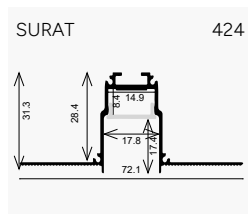

PERFILES DE SUELO / SOIL PROFILES / PROFILÉS DE SOL / PROFILI DEL PAVIMENTO

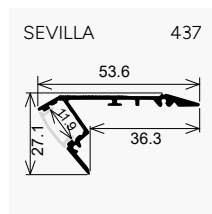
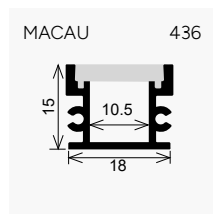

PERFILES FLEXIBLES / FLEXIBLES PROFILES / PROFILÉS FLEXIBLES / PROFILI FLESSIBILI

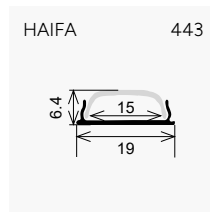
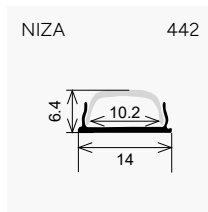
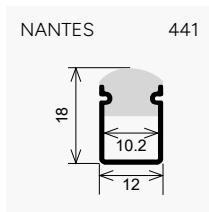
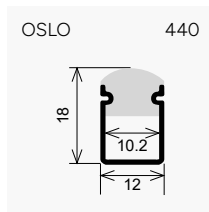

PERFIL IMANTADO / MAGNETIC PROFILE / PROFIL MAGNÉTIQUE / PROFILO MAGNETICO

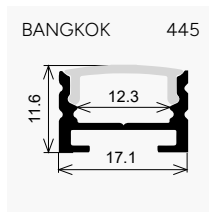

PERFIL ARMARIO / WARDROBE PROFILE / PROFIL ARMARIO / PROFILO ARMARIO

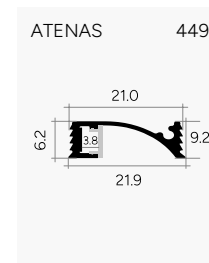
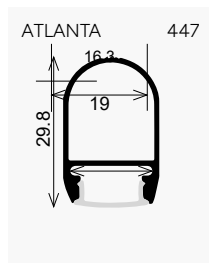

FUENTE DE ALIMENTACIÓN / POWER SUPPLY / ALIMENTATION ÉLECTRIQUE / ALIMENTAZIONE ELETTRICA



SISTEMAS DE CONTROL / CONTROL SYSTEMS / SYSTÈMES DE CONTRÔLE / SISTEMI DI CONTROLLO

<p>24V 460 -464</p> 	<p>230V 465 -467</p> 	<p>1-10V 468 -469</p> 	<p>DALI 470 -471</p> 
<p>CASAMBI 472 -475</p> 	<p>ESCALERAS 476 STAIRS / ESCALIERS SCALE</p> 	<p>SMART DRIVER 477 -478</p> 	<p>SENSORES 24V 479 SENSORS / DÉTECTUR SENSORI 24V</p> 
<p>MANDOS 481 CONTROLS / CONTRÔLES CONTROLLI</p> 	<p>PULSADORES 485 PUSHBUTTONS / BOUTONS POUSSOIR / PULSANTI</p> 	<p>CENTRAL WIFI 487 WIFI CENTER / CENTRE WI-FI / CENTRO WIFI</p> 	

GUÍA COMPOSICIÓN TIRAS, CONTROLADORES Y MANDOS 488-491
 / STRIP COMPOSITION GUIDE, CONTROLLERS AND CONTROLS
 / GUIDE DE COMPOSITION DES BANDES, CONTRÔLEURS ET CONTRÔLES
 / COMPOSIZIONE STRISCE GUIDA, CONTROLLER E CONTROLLI

OPCIONES DE CORTE / CUTTING OPTIONS / OPTIONS DE COUPE / OPZIONI DI TAGLIO 492-493

EXPOSITORES / EXHIBITORS / EXPOSANTS / ESPOSITORI 494-495

CONDICIONES DE VENTA / TERMS OF SALE / CONDITIONS DE VENTE / CONDIZIONI DI VENDITA 496-499

↓ Browse the web

Naviguer sur le web

Navigare sul web

NAVEGA POR LA WEB

Subscribe to our newsletter and we will send you news and information about new trends.



Referencia / Reference / Référence / Riferimento

Cómo formar la referencia de producto / How to form the product reference / Comment former la référence du produit / Come si forma il riferimento al prodotto:

ES_ Nuestras referencias de producto están diseñadas para ser intuitivas. Imagina que seleccionas un producto con las siguientes características. EN_ Our product references are designed to be intuitive. Imagine you select a product with the following characteristics. FR_ Nos références de produits sont conçues pour être intuitives. Imaginez que vous sélectionnez un produit présentant les caractéristiques suivantes. IT_ I nostri riferimenti ai prodotti sono progettati per essere intuitivi. Immaginate di selezionare un prodotto con le seguenti caratteristiche.

Power: 6W
CCT: 3000K
Color outside: Blanco
Color inside: Blanco y negro
Optica: 38
Dimmable: ON/OFF

CODE	W	Lm	K	OUTSIDE	INSIDE	BEAM	DIMMABLE
64800	6W	480Lm	27 2700K	B ○	B ○	26	SR ON/OFF
64801	6W	480Lm	30 3000K	N ●	N ●	38	A TRIAC
			40 4000K		BN ●		B 1-10V
					BO ●		C DALI/PUSH
					NO ●		

64800			30		BN	38	SR
-------	--	--	----	--	----	----	----

ES_ Para formar la referencia se haría de la siguiente manera:

Seleccione el CODE y añada los caracteres marcados en azul según las características que prefiere que disponga el producto.

Al combinar estos elementos, la referencia para este producto sería: **6480030BN38SR**.

EN_ To form the reference would be done as follows:

Select the CODE and add the characters marked in blue according to the features you prefer the product to have.

Combining these items, the ordering number for this product would be: **6480030BN38SR**.

FR_ Pour constituer la référence, procédez comme suit :

Sélectionnez le CODE et ajoutez les caractères marqués en bleu en fonction de vos préférences. les caractéristiques que vous souhaitez donner au produit.

En combinant ces éléments, le numéro de référence de ce produit serait : **6480030BN38SR**.

IT_ Per formare il riferimento, procedere come segue:

Selezionate il CODICE e aggiungete i caratteri contrassegnati in blu in base alle caratteristiche del prodotto che preferite.

Combinando questi elementi, il numero d'ordine di questo prodotto sarebbe: **6480030BN38SR**.

Simbología

SYMBOLGY / SYMBOLOGIE / SIMBOLOGIA

 Led Chip Edison

 Led Chip Bridgelux

 Led Chip Cree

 Led Chip Epistar

 Led Chip Ever Light

 Led Chip Sanan

 Led Chip Luminus

 Led Chip Tridonic

 Led Driver Tridonic

 Led Driver AGT

 Led Driver Sosen

 Led Driver Hep

 Led Driver Osram

 Led Driver Alloking

 Led Driver Eaglerise

 Led Driver Lifud

 Led Driver Kegu

 Smart Control

 Voltaje / Voltage / Tension / Tensione

 Disponible en versión emergencia
Available in emergency version
Disponibile in versione d'urgence
Disponibile in versione di emergenza

 Protector sobretensiones
Surge protector
Parasurtenseur
Protettore di sovratensione

 Cociente de deslumbramiento
Clare quotient
Quotient d'éblouissement
Quoziente di abbagliamento

 Grado de impermeabilidad y resistencia al polvo / Degree of waterproofing and dust resistance / Degré d'étanchéité et de résistance à la poussière / Grado di impermeabilità e resistenza alla polvere

 Certificación diseñada para asegurar que el equipo pueda resistir los lavados a alta presión y con vapor / Certification designed to ensure that the equipment can withstand high pressure and steam wash downs / Certification conçue pour garantir que l'équipement peut résister à la haute pression et aux lavages à la vapeur / Certificazione progettata per garantire che l'apparecchiatura sia in grado di resistere alle alte pressioni e ai lavaggi a vapore

 Resistencia mecánica a los golpes
Mechanical shock resistance
Résistance aux chocs mécaniques
Resistenza agli urti meccanici

 Temperatura de trabajo
Working temperature
Température de travail
Temperatura di lavoro

 Equipo incluido
Equipment included
Équipement inclus
Driver inclusa

 Equipo no incluido
Equipment not included
Équipement non inclus
Driver non inclusa

 Clase I. Clase de aislamiento eléctrico
Class I. Electrical insulation class
Classe I. Classe d'isolation électrique
Classe I. Classe di isolamento elettrico

 Clase II. Clase de aislamiento eléctrico
Class II. Electrical insulation class
Classe II. Classe d'isolation électrique
Classe II. Classe di isolamento elettrico







 Clase III. Clase de aislamiento eléctrico
Class III. Electrical insulation class
Classe III. Classe d'isolation électrique
Classe III. Classe di isolamento elettrico















 Dispositivo para tránsito de vehículos
Vehicle Transit Device
Dispositif de transit des véhicules
Dispositivo di transit del veicolo

 Pisable por paso humano
Walkable by human foot traffic
Praticable par les piétons
Può essere calpestato da passi umani

 Haz de luz orientable
Adjustable light beam
Faisceau lumineux réglable
Fascio di luce regolabile

SYMBOLGY / SYMBOLOGIE / SIMBOLOGIA

	Haz de luz basculante Tilting light beam Faisceau lumineux inclinable Fascio di luce inclinabile
	Caja de empotrar incluida Embedding box included Boîte d'encastrement incluse Scatola di incorporamento inclusa
	Instalación sin marco Frameless installation Installation sans cadre Installazione senza telaio
	Posibilidad de pintado Possibility of painting Possibilité de peinture Possibilità di dipingere
	Agujero de corte cuadrado Square installation hole Trou d'installation carré Foro di installazione quadrato
	Agujero de corte redondo Round installation hole Trou d'installation rond Foro di installazione rotondo
	Conformidad con los estándares de la UE Conformity with EU standards Conformité aux normes de l'UE Conformità agli standard UE
	Años de garantía Years of guarantee Années de garantie Anni di garanzia
	Atmósfera explosiva Explosive atmosphere Atmosphère explosive Atmosfera esplosiva
	Cable de alimentación incluido Power cable included Câble d'alimentation inclus Cavo di alimentazione incluso
	Sumergible Submersible Submersibile Sommergibile
	Equipo hermético al polvo y protegido contra el agua proyectada / Dust-tight and splash-water-protected equipment / Équipement étanche à la poussière et aux éclaboussures d'eau / Apparecchiature a tenuta di polvere e protette dagli spruzzi d'acqua
	Protección extra para ambientes salino / Additional protection for saline environments / Protection supplémentaire pour les environnements salins / Protezione extra per ambienti salini
	Molde exclusivo LYOPRO Exclusive LYOPRO mould Moule exclusif LYOPRO Stampo esclusivo LYOPRO

	Ángulo de apertura Opening angle Angle d'ouverture Angolo di apertura
	Reproducción cromática Color rendering Rendu des couleurs Resa cromatica
	Instalación interior Indoor installation Installation intérieure Installazione interna
	Instalación exterior Outdoor installation Installation extérieure Installazione esterna
	Instalación en pared Wall installation Installation murale Installazione a parete
	Instalación en suelo Floor installation Installation du plancher Installazione del pavimento
	Instalación en techo Ceiling installation Installation du plafond Installazione a soffitto
	Instalación en suspensión Suspension installation Installation de la suspension Installazione delle sospensioni
	Tira flexible Flexible strip Bande flexible Striscia flessibile
	Altura de la tira Height of the strip Hauteur de la bande Altezza della striscia
	Max. metros de corriente continua Max meters continuous line Max mètres de ligne continue Max metri di linea continua
	Sensor de movimiento Motion sensor Décteur de mouvement Sensore di movimento
	Sensor crepuscular Twilight sensor Capteur crépusculaire Sensore crepuscolare
	Selector de potencia Power selector Sélecteur de puissance Selettore di potenza
	Salidas de luz disponibles Available light outputs Sorties lumineuses disponibles Emissioni luminose disponibili

mini downlight empotrar

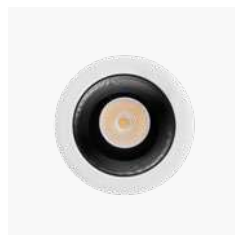
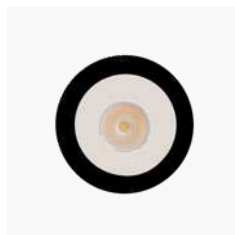

MINI DOWNLIGHTS
DE EMPOTRAR

RECESSED
MINI DOWNLIGHTS

MINI DOWNLIGHTS
ENCASTRÉS

MINI DOWNLIGHTS
INCORPORATO



Image: ARASH models



ARASH



○ Redondo / Round / Rond / Tondo

◻ Cuadrado / Square / Carrè / Quadrato

CODE	W	Lm	K	VERSION	BEAM°	COLOR	PRICE
60015	3W	270Lm	2700K	○	30	○	24,95€
60016	3W	285Lm	3000K	○	30	○	24,95€
60017	3W	300Lm	4000K	○	30	○	24,95€
60019	3W	285Lm	3000K	◻	30	○	24,95€
60020	3W	300Lm	4000K	◻	30	○	24,95€
60021	3W	270Lm	2700K	○	30	●	26,95€
60022	3W	285Lm	3000K	○	30	●	26,95€
60023	3W	300Lm	4000K	○	30	●	26,95€



ROUND

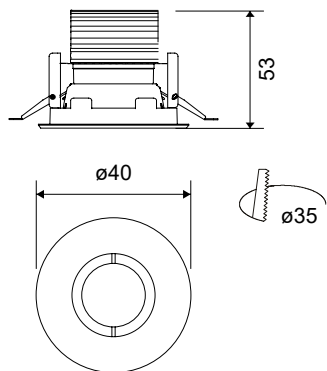

SQUARE

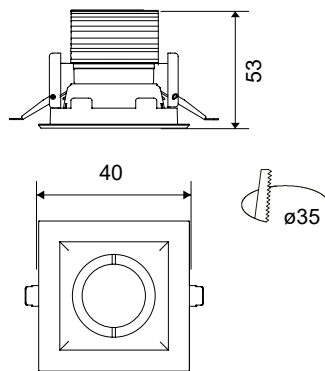

LISA

NEW PRODUCT



⊙ Redondo / Round / Rond / Tondo

CODE	W	Lm	K	VERSION	BEAM°	COLOR	DIMMABLE	PRICE
60410	1W	90Lm	2700K	R ⊙	15	B ○	SR ON/OFF	22,95€
60411	1W	95Lm	3000K		27	N ●		22,95€
60412	1W	100Lm	4000K		60	BN ●		22,95€
						NB ●		22,95€

CODE	W	Lm	K	VERSION	BEAM°	COLOR	DIMMABLE	PRICE
60400	3W	270Lm	2700K	R ⊙	15	B ○	SR ON/OFF	29,95€
60401	3W	285Lm	3000K		25	N ●	A TRIAC	49,95€
60402	3W	300Lm	4000K		50	BN ●	B 1-10V	49,95€
						NB ●	C DALI/PUSH	59,95€



1W

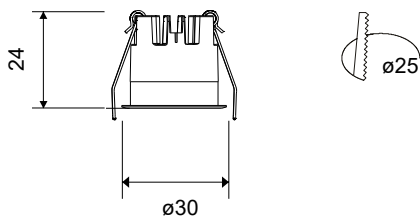

3W

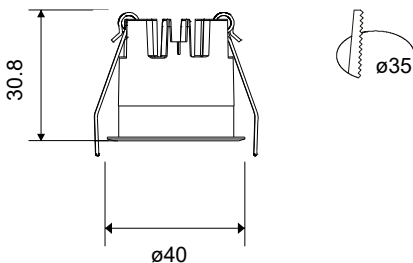



downlight empotrar



DOWNLIGHTS
DE EMPOTRAR

RECESSED
DOWNLIGHTS

DOWNLIGHTS
ENCASTRÉS

DOWNLIGHTS
INCORPORATO



CORAL



Gu-10 included



○ Redondo / Round
/ Rond / Tondo



◻ Cuadrado / Square /
Carré / Quadrato



○ Redondo asimétrico
Asymmetrical round
Rond asymétrique
Rotondo asimmetrico



◻ Cuadrado asimétrico
Asymmetrical square
Carré asymétrique
Quadrato asimmetrico

CODE	VERSION	COLOR	PRICE	ROUND	SQUARE	A. ROUND	A. SQUARE
12430	R ○	B ○	5,95€	H: 52	H: 54	H: 55	H: 55
12431	R ○	N ●	5,95€				
12436	C ◻	B ○	5,95€				
12437	C ◻	N ●	5,95€				
12442	RA ○	B ○	6,95€				
12443	RA ○	N ●	6,95€				
12448	CA ◻	B ○	6,95€				
12449	CA ◻	N ●	6,95€				

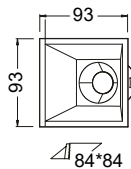
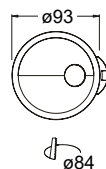
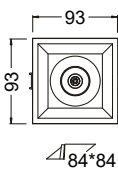
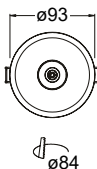

*La altura indicada no contempla la altura de la dicroica. *The indicated height does not include the height of the dichroic lamp. La hauteur indiquée ne comprend pas la hauteur de la lampe dichroïque. L'altezza indicata non include l'altezza della lampada dicroic.*



Se recomienda el uso de la lámpara dicroica SMD de 7,5 W (no incluida). Véase página 255
The use of the 7.5 W SMD dichroic lamp is recommended (not included). See page 255
L'utilisation de la lampe dichroïque SMD de 7,5 W est recommandée (non incluse). Voir page 255
Si consiglia l'uso della lampada dicroica SMD da 7,5 W (non inclusa). Vedere pagina 255

CORAL TILT



Gu-10 included



NEW PRODUCT



- Redondo basculante / Tilting round / Rond basculant / Rotondo ribaltabile

CODE	VERSION	COLOR	PRICE
12434	R	B	6,95€
12435	R	N	6,95€



$\varnothing 85$ mm

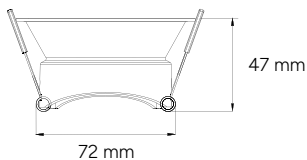
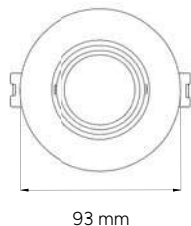

Se recomienda el uso de la lámpara dicroica SMD de 7,5 W (no incluida). Véase página 255
 The use of the 7.5 W SMD dichroic lamp is recommended (not included). See page 255
 L'utilisation de la lampe dichroïque SMD de 7,5 W est recommandée (non incluse). Voir page 255
 Si consiglia l'uso della lampada dicroica SMD da 7,5 W (non inclusa). Vedere pagina 255

SIRA Downlight Series:











**Exclusive LYOPRO
Mold, Guarantee
of Originality and
Higher Quality**

SIRA

 EXCLUSIVE
LYOPRO MOLD

IP54 







CODE	W	Lm	K	VERSION	BEAM°	COLOR	DIMMABLE	PRICE
60296	3W	270Lm	2700K	R 	15	B 	SR ON/OFF	28,95€
60297	3W	285Lm	3000K		24	N 	A TRIAC	51,95€
60298	3W	300Lm	4000K		38	BR 	B 1-10V	51,95€
						BO 	C DALI/PUSH	61,95€
						BPM 		
						BN 		

SIRA TRIMLESS

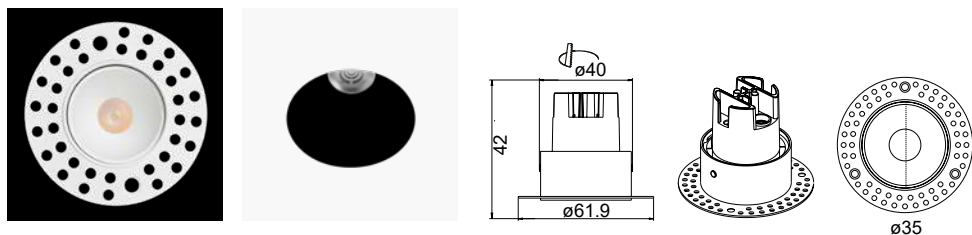

IP54 



CODE	W	Lm	K	VERSION	BEAM°	COLOR	DIMMABLE	PRICE
60296	3W	270Lm	2700K	TR 	15	B 	SR ON/OFF	34,95€
60297	3W	285Lm	3000K		24	N 	A TRIAC	59,95€
60298	3W	300Lm	4000K		38		B 1-10V	59,95€
							C DALI/PUSH	69,95€

 CREE
LED CHIP

 EAGLE RISE
LED DRIVER

IP
54

 UGR < 19



220-240V
50/60Hz

ALU
PC

EM



5
YEAR

Smart Control



-20 / +50

Cri > 90



Image: IP65 SIRA models





SIRA



EXCLUSIVE
LYOPRO MOLD

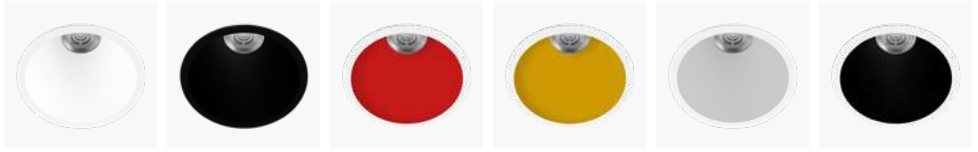

CODE	W	Lm	K	VERSION	BEAM°	COLOR	DIMMABLE	PRICE
60299	5W	450Lm	2700K	R65	15	B	SR ON/OFF	29,95€
60300	5W	475Lm	3000K	R	24	N	A TRIAC	53,95€
60301	5W	500Lm	4000K		38	BR	B 1-10V	53,95€
						BO	C DALI/PUSH	63,95€
						BPM		
						BN		

IP65

CODE	W	Lm	K	VERSION	BEAM°	COLOR	DIMMABLE	PRICE
60299	5W	450Lm	2700K	IR65	15	B	SR ON/OFF	36,95€
60300	5W	475Lm	3000K	IR	24	N	A TRIAC	59,95€
60301	5W	500Lm	4000K		38		B 1-10V	59,95€
							C DALI/PUSH	69,95€

R65 / IR65

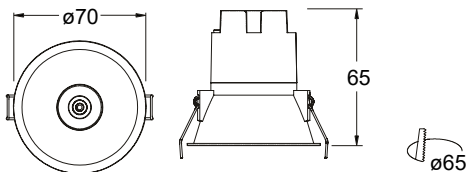



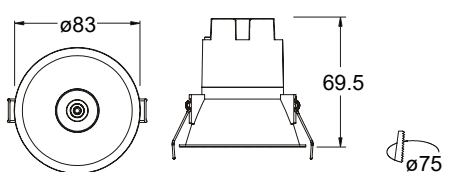

R / IR

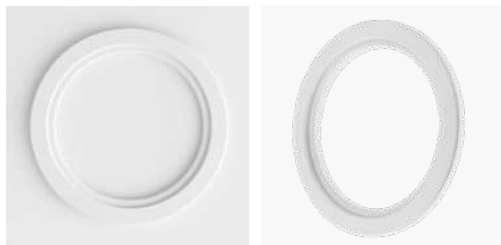

Accesorios ARO SIRA 5W

NEW PRODUCT



CODE	VERSION	COLOR	PRICE
60290	R65 / IR65 	B 	1,85€
60291	R / IR 	B 	1,85€



R65 / IR65

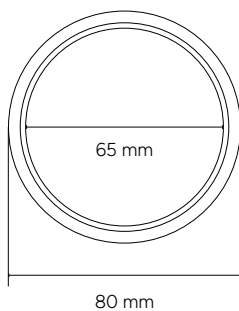

R / IR

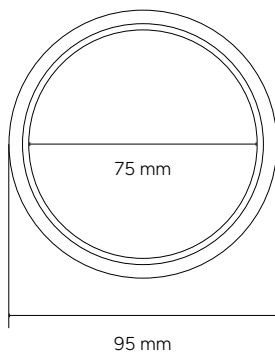



SIRA TRIMLESS

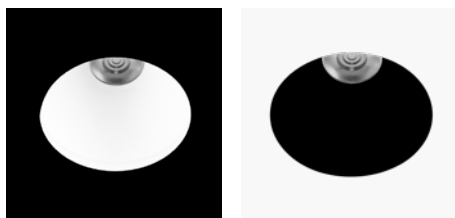

 EXCLUSIVE
LYOPRO MOLD



CODE	W	Lm	K	VERSION	BEAM°	COLOR	DIMMABLE	PRICE
60299	5W	450Lm	2700K	TR 	15	B 	SR ON/OFF	43,95€
60300	5W	475Lm	3000K		24	N 	A TRIAC	68,95€
60301	5W	500Lm	4000K		38		B 1-10V	68,95€
							C DALI/PUSH	78,95€















 Cri>90

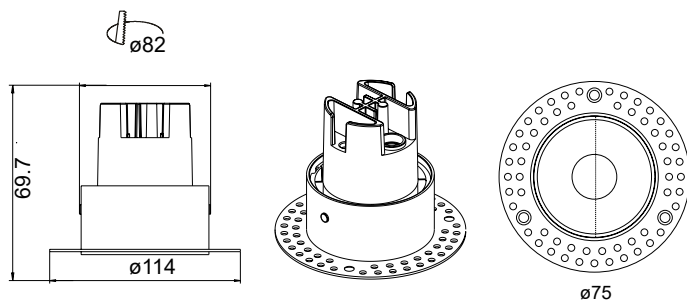



Image:SIRA 5W trimless design

Image: SIRA TRIMLESS models





**Efficient and
elegant lighting
for any space.**

SIRA



EXCLUSIVE
LYOPRO MOLD



CODE	W	Lm	K	VERSION	BEAM°	COLOR	DIMMABLE	(R) PRICE	(R100) PRICE
60302	10W	900Lm	2700K	R	15	B SR	ON/OFF	37,95€	39,95€
60303	10W	950Lm	3000K	R100	24	N A	TRIAC	59,95€	64,95€
60304	10W	1000Lm	4000K		38	BR B	1-10V	59,95€	64,95€
						BO C	DALI/PUSH	69,95€	74,95€
						BPM			
						BN			



IP65

CODE	W	Lm	K	VERSION	BEAM°	COLOR	DIMMABLE	(R) PRICE	(R100) PRICE
60302	10W	900Lm	2700K	IR	15	B SR	ON/OFF	45,95€	49,95€
60303	10W	950Lm	3000K	IR100	24	N A	TRIAC	69,95€	74,95€
60304	10W	1000Lm	4000K		38	B	1-10V	69,95€	74,95€
						C	DALI/PUSH	79,95€	84,95€



R / IR



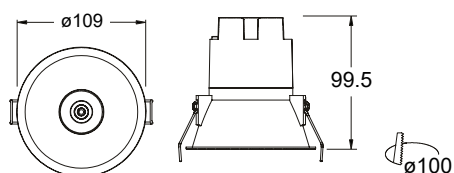
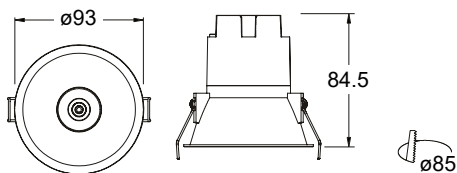

R100 / IR100

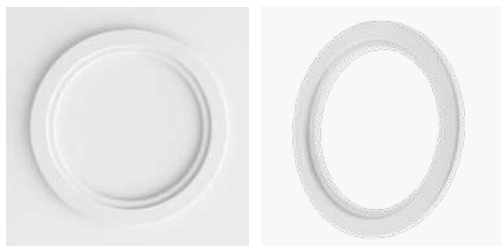

Accesorios ARO SIRA 10W

NEW PRODUCT



CODE	VERSION	COLOR	PRICE
60292	R / IR 	B 	1,95€
60293	R100 / IR100 	B 	1,95€



R / IR

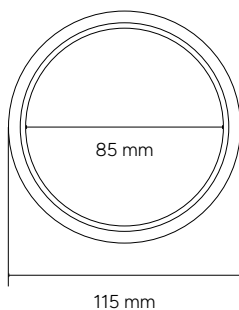

R100 / IR100

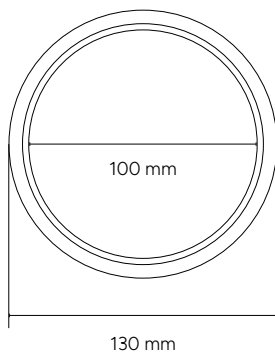

SIRA TRIMLESS



EXCLUSIVE
LYPRO MOLD

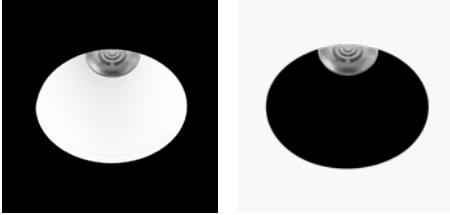

CODE	W	Lm	K	VERSION	BEAM°	COLOR	DIMMABLE	PRICE
60302	10W	900Lm	2700K	TR	15	B	SR ON/OFF	49,95€
60303	10W	950Lm	3000K		24	N	A TRIAC	74,95€
60304	10W	1000Lm	4000K		38		B 1-10V C DALI/PUSH	74,95€ 84,95€

Cri>90

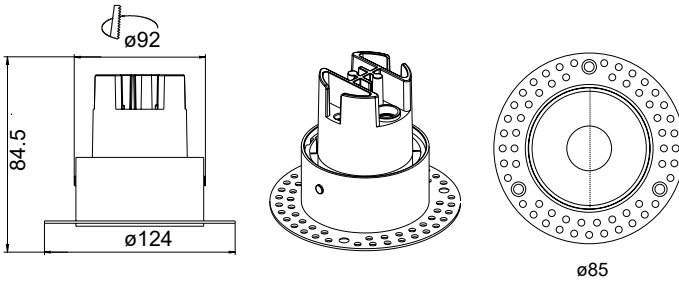

DISCOVER THE LATEST

Subscribe to our newsletter and we will send you news
and information about new trends.



Image: SIRA asymmetric and square designs

**Luminous geometry,
radiant design.**







○ Redondo asimétrico
Asymmetrical round
Rond asymétrique
Rotondo asimmetrico

◻ Cuadrado asimétrico
Asymmetrical square
Carré asymétrique
Quadrato asimmetrico

CODE	W	Lm	K	VERSION	BEAM°	COLOR	DIMMABLE	PRICE
60299	5W	450Lm	2700K	RA75 ○	15	B ○	SR ON/OFF	29,95€
60300	5W	475Lm	3000K	RA ○	24	N ●	A TRIAC	55,95€
60301	5W	500Lm	4000K	CA ◻	38	BR ●	B 1-10V	55,95€
						BO ●	C DALI/PUSH	65,95€
						BPM ●		
						BN ●		

RA75

RA

CA

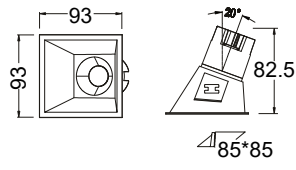
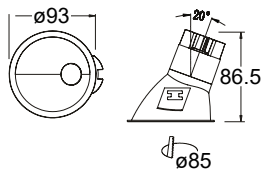
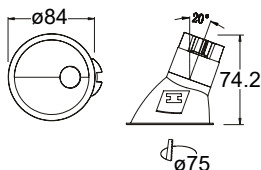



□ Cuadrado / Square / Carrè / Quadrato

CODE	W	Lm	K	VERSION	BEAM°	COLOR	DIMMABLE	PRICE
60302	10W	900Lm	2700K	C □	15	B ○	SR ON/OFF	37,95€
60303	10W	950Lm	3000K		24	N ●	A TRIAC	61,95€
60304	10W	1000Lm	4000K		38	BR ●	B 1-10V	61,95€
						BO ●	C DALI/PUSH	71,95€
						BPM ●		
						BN ●		

Cri > 90

IP65

CODE	W	Lm	K	VERSION	BEAM°	COLOR	DIMMABLE	PRICE
60302	10W	900Lm	2700K	IC □	15	B ○	SR ON/OFF	46,95€
60303	10W	950Lm	3000K		24	N ●	A TRIAC	69,95€
60304	10W	1000Lm	4000K		38	B ●	B 1-10V	69,95€
						C ●	C DALI/PUSH	79,95€

Cri > 90

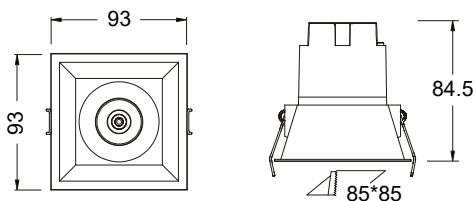







SIRA

 EXCLUSIVE
LYOPRO MOLD

IP54 



CODE	W	Lm	K	VERSION	BEAM°	COLOR	DIMMABLE	PRICE
64299	20W	1800Lm	2700K	R 	15	B 	SR ON/OFF	59,95€
64300	20W	1900Lm	3000K		24	N 	A TRIAC	89,95€
64301	20W	2000Lm	4000K		38	BR 	B 1-10V	89,95€
						BO 	C DALI/PUSH	99,95€
						BPM 		
						BN 		

















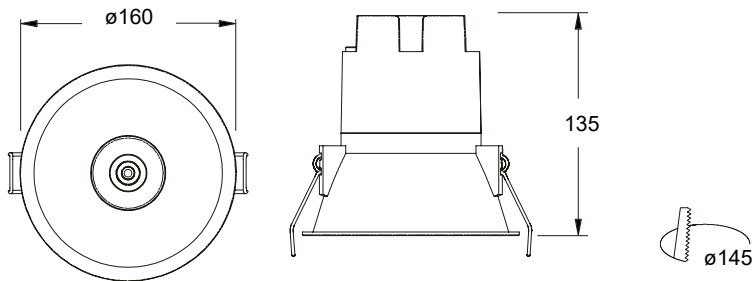

 -20 / +50 Cri > 90









SIRA

 EXCLUSIVE
LYOPRO MOLD

IP54 



CODE	W	Lm	K	VERSION	BEAM°	COLOR	DIMMABLE	PRICE
64302	30W	2700Lm	2700K	R 	15	B 	SR ON/OFF	89,95€
64303	30W	2850Lm	3000K		24	N 	A TRIAC	139,95€
64304	30W	3000Lm	4000K		38	BR 	B 1-10V	139,95€
						BO 	C DALI/PUSH	149,95€
						BPM 		
						BN 		

 **CREE**  **Lifud**  **IP 54**  **UGR < 19**   **220-240V 50/60Hz**  **Alu PC**  **EM**    **CE**  **5**  **Smart Control**  **-20 / +50** **Cri > 90**

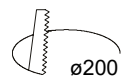
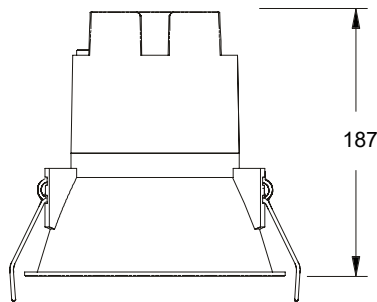
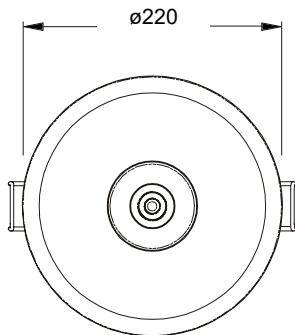

DELIA

NEW PRODUCT



2700 - 3000 - 4000K



○ Redondo / Round / Rond / Tondo □ Cuadrado / Square / Carrè / Quadrato

CODE	W	Lm	K	VERSION	BEAM°	COLOR	DIMMABLE		PRICE
62710	7W	700Lm	3 CCT	R ○	15	B ○	SR	ON/OFF	49,95€
				C □	24	N ●	A	TRIAC	69,95€
					36	BN ●	B	1-10V	69,95€
						NB ●	C	DALI/PUSH	79,95€
CODE	W	Lm	K	VERSION	BEAM°	COLOR	DIMMABLE		PRICE
62711	12W	1200Lm	3 CCT	R ○	15	B ○	SR	ON/OFF	79,95€
				C □	24	N ●	A	TRIAC	109,95€
					36	BN ●	B	1-10V	109,95€
						NB ●	C	DALI/PUSH	119,95€
CODE	W	Lm	K	VERSION	BEAM°	COLOR	DIMMABLE		PRICE
62713	30W	3000Lm	3 CCT	R ○	15	B ○	SR	ON/OFF	109,95€
				C □	24	N ●	A	TRIAC	149,95€
					36	BN ●	B	1-10V	149,95€
						NB ●	C	DALI/PUSH	159,95€



Cri > 90

ROUND 7W

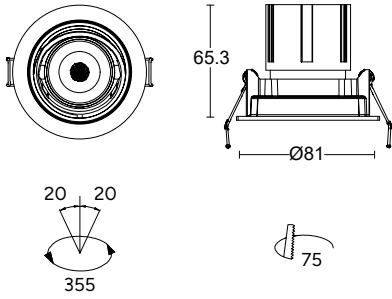

SQUARE 7W

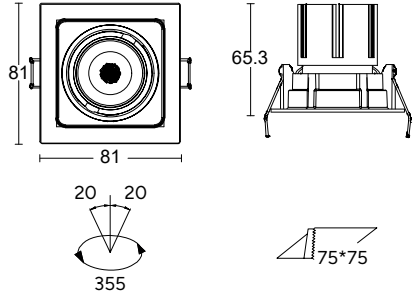

ROUND 12W

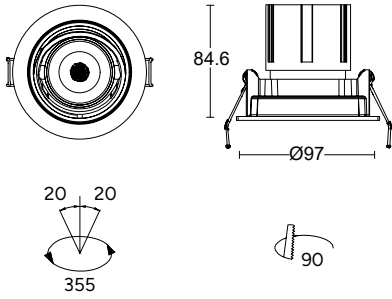

SQUARE 12W

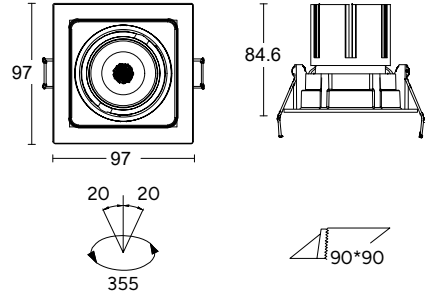

ROUND 30W

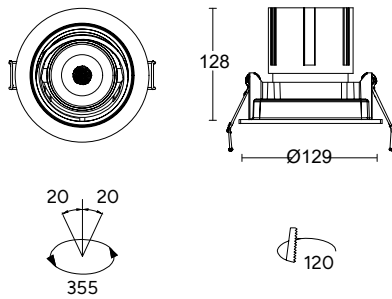

SQUARE 30W

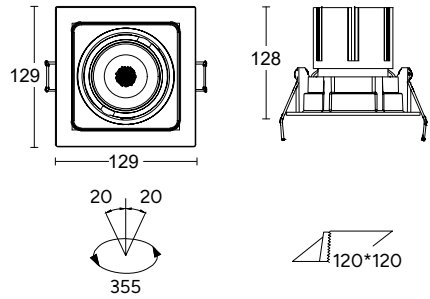

DELIA

NEW PRODUCT



2700 - 3000 - 4000K



Doble / Double / Doppio

CODE	W	Lm	K	VERSION	BEAM°	COLOR	DIMMABLE		PRICE
62760	2x7W	1400Lm	3 CCT		15	B ○	SR	ON/OFF	99,95€
					24	N ●	A	TRIAC	149,95€
					36		B	1-10V	149,95€
							C	DALI/PUSH	159,95€

CODE	W	Lm	K	VERSION	BEAM°	COLOR	DIMMABLE		PRICE
62761	2x12W	2400Lm	3 CCT		15	B ○	SR	ON/OFF	139,95€
					24	N ●	A	TRIAC	179,95€
					36		B	1-10V	179,95€
							C	DALI/PUSH	189,95€

CODE	W	Lm	K	VERSION	BEAM°	COLOR	DIMMABLE		PRICE
62763	2x30W	6000Lm	3 CCT		15	B ○	SR	ON/OFF	199,95€
					24	N ●	A	TRIAC	289,95€
					36		B	1-10V	289,95€
							C	DALI/PUSH	299,95€



2X7W

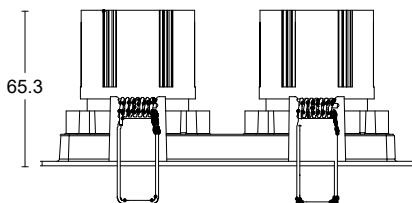
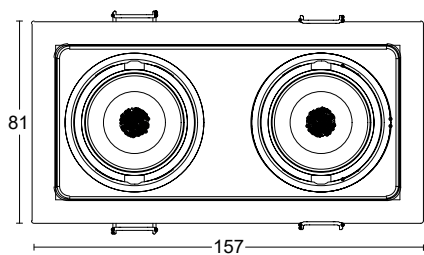

2X12W

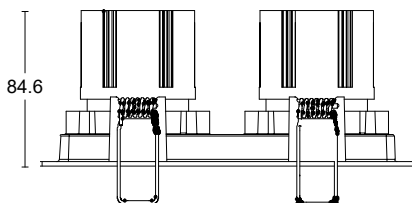
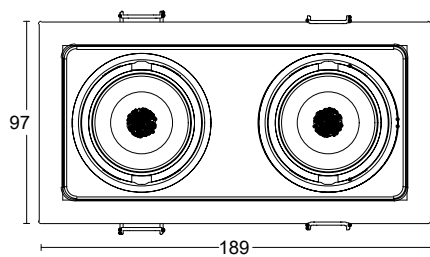

2X30W

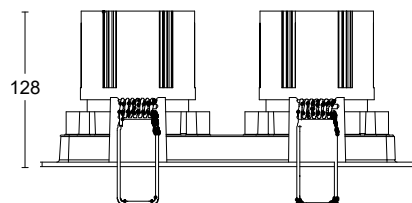
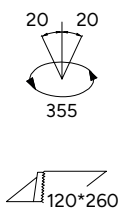
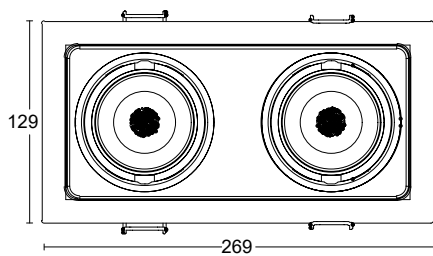

Image: DELIA design







Image: DEO models

DEO



2700 - 3000 - 4000K



Altura ultrabaja / Ultra-low height

CODE	W	Lm	K	OUTSIDE	BEAM°	INSIDE	DIMMABLE	PRICE
62952	9W	900Lm	3 CCT	B ○	18	B ○	SR ON/OFF	29,95€
62953	9W	900Lm	3 CCT	N ●	24	N ●	A TRIAC	49,95€
					36		B 1-10V	49,95€
					60		C DALI/PUSH	69,95€

CODE	W	Lm	K	OUTSIDE	BEAM°	INSIDE	DIMMABLE	PRICE
62954	12W	1200Lm	3 CCT	B ○	18	B ○	SR ON/OFF	39,95€
62955	12W	1200Lm	3 CCT	N ●	24	N ●	A TRIAC	59,95€
					36		B 1-10V	59,95€
					60		C DALI/PUSH	79,95€



9W

12W

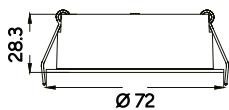

ATLAS



3000 - 4000 - 6000K



6W

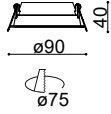

9W

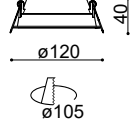

12W

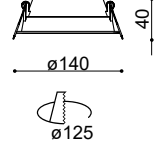

CODE	W	Lm	K	BEAM°	COLOR	DIMMABLE	PRICE
12400	6W	660Lm	3 CCT	120	○	SR ON/OFF	11,95€
						A TRIAC	34,95€
						B 1-10V	34,95€
						C DALI/PUSH	40,95€
12401	9W	990Lm	3 CCT	120	○	SR ON/OFF	13,95€
						A TRIAC	36,95€
						B 1-10V	36,95€
						C DALI/PUSH	46,95€
12402	12W	1320Lm	3 CCT	120	○	SR ON/OFF	17,95€
						A TRIAC	39,95€
						B 1-10V	39,95€
						C DALI/PUSH	49,95€
12403	15W	1650Lm	3 CCT	120	○	SR ON/OFF	21,95€
						A TRIAC	46,95€
						B 1-10V	46,95€
						C DALI/PUSH	52,95€
12404	20W	2200Lm	3 CCT	120	○	SR ON/OFF	29,95€
						A TRIAC	49,95€
						B 1-10V	49,95€
						C DALI/PUSH	55,95€

EPISTAR LED CHIP
 Lifud LED Driver
 IP 43
 UGR < 19
 220-245V 50/60Hz
 Alu PC
 PC Opal Diffuser
 EM
 CE
 3
 Smart Control
 Cri > 80

15W

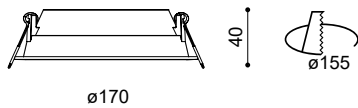

20W

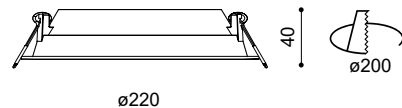



Image: ATLAS models

Image: SWEET models



SWEET



2700 - 3000 - 4000K



⊙ Redondo / Round / Rond / Tondo

CODE	W	Lm	K	VERSION	BEAM°	COLOR	DIMMABLE	PRICE
63020	10W	1100Lm	3 CCT	⊙	120	B ○	SR ON/OFF	17,95€
						N ●	A TRIAC	49,95€
						P ○	B 1-10V	52,95€
						C DALI/PUSH	59,95€	
63024	15W	1650Lm	3 CCT	⊙	120	B ○	SR ON/OFF	24,95€
						N ●	A TRIAC	54,95€
						P ○	B 1-10V	56,95€
						C DALI/PUSH	64,95€	
63028	20W	2200Lm	3 CCT	⊙	120	B ○	SR ON/OFF	44,95€
						N ●	A TRIAC	79,95€
						P ○	B 1-10V	81,95€
						C DALI/PUSH	97,95€	
63032	30W	3300Lm	3 CCT	⊙	120	B ○	SR ON/OFF	54,95€
						N ●	A TRIAC	87,95€
						P ○	B 1-10V	89,95€
						C DALI/PUSH	99,95€	

EPISTAR LED CHIP
 LIFUD LED Driver
 IP 44
 UGR < 19
 220-245V 50/60Hz
 Alu PC
 PC Opal Diffuser
 EM
 CE
 5 Year
 Smart Control
 Cri > 80

10W

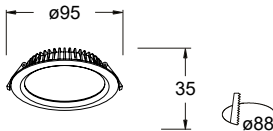

15W

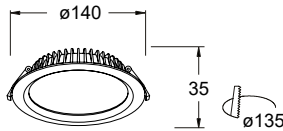

20W & 30W

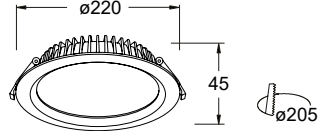



Cuadrado / Square / Carrè / Quadrato

CODE	W	Lm	K	VERSION	BEAM°	COLOR	DIMMABLE	PRICE
63040	10W	1100Lm	3 CCT	<input type="checkbox"/>	120	B <input type="radio"/>	SR ON/OFF	17,95€
						N <input checked="" type="radio"/>	A TRIAC	49,95€
						P <input type="radio"/>	B 1-10V	52,95€
						C DALI/PUSH	59,95€	
63044	15W	1650Lm	3 CCT	<input type="checkbox"/>	120	B <input type="radio"/>	SR ON/OFF	24,95€
						N <input checked="" type="radio"/>	A TRIAC	54,95€
						P <input type="radio"/>	B 1-10V	56,95€
						C DALI/PUSH	64,95€	
63048	20W	2200Lm	3 CCT	<input type="checkbox"/>	120	B <input type="radio"/>	SR ON/OFF	44,95€
						N <input checked="" type="radio"/>	A TRIAC	79,95€
						P <input type="radio"/>	B 1-10V	81,95€
						C DALI/PUSH	97,95€	
63052	30W	3300Lm	3 CCT	<input type="checkbox"/>	120	B <input type="radio"/>	SR ON/OFF	54,95€
						N <input checked="" type="radio"/>	A TRIAC	87,95€
						P <input type="radio"/>	B 1-10V	89,95€
						C DALI/PUSH	99,95€	

EPISTAR LED CHIP
 LiFuD LED Driver
 IP 44
 UGR < 19
 220-245V 50/60Hz
 Alu PC
 PC Opal Diffuser
 EM
 CE
 5 Year
 Smart Control
 -20/+50
 Cri>80

10W

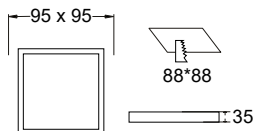

15W

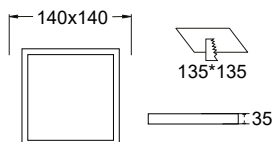

20W & 30W

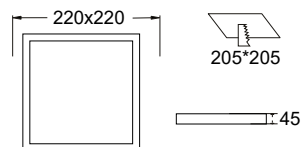



Image: SWEET models



90°adjust



350°rotate





MOON



Gu-10 included



CODE	MATERIAL	COLOR	PRICE
12320	Aluminium	B ○	24,95€
12321	Aluminium	N ●	24,95€

GU-10 **IP** 20 **220-245V** **Alu** EM    **CE** **5** YEAR WARRANTY

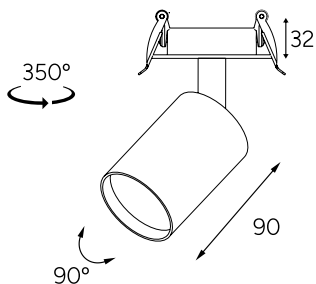
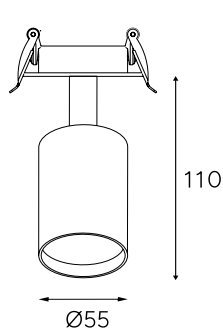

Se recomienda el uso de la lámpara dicroica SMD de 7,5 W (no incluida). Véase página 255
 The use of the 7.5 W SMD dichroic lamp is recommended (not included). See page 255
 L'utilisation de la lampe dichroïque SMD de 7,5 W est recommandée (non incluse). Voir page 255
 Si consiglia l'uso della lampada dicroica SMD da 7,5 W (non inclusa). Vedere pagina 255

mini downlight superficie

MINI DOWNLIGHTS DE SUPERFICIE

ES_ Compactos, modernos y eficientes, los Mini Downlights son para quienes buscan combinar estilo y funcionalidad. Su diseño elegante realza cualquier ambiente, mientras que su fácil instalación y bajo consumo energético los convierten en una solución práctica, sostenible y adaptable a todo tipo de proyectos.

SURFACE MINI DOWNLIGHTS

EN_ Compact, modern and efficient, Mini Downlights are for those who seek to combine style and functionality. Their elegant design enhances any environment, while their easy installation and low energy consumption make them a practical, sustainable and adaptable solution for all types of projects.

MINI DOWNLIGHTS DE SURFACE

FR_ Compacts, modernes et efficaces, les mini Downlights sont destinés à ceux qui cherchent à combiner style et fonctionnalité. Leur design élégant met en valeur n'importe quel environnement, tandis que leur facilité d'installation et leur faible consommation d'énergie en font une solution pratique, durable et adaptable à tous les types de projets.

MINI DOWNLIGHTS DI SUPERFICIE

IT_ Compatti, moderni ed efficienti, i Mini Downlight sono pensati per chi vuole coniugare stile e funzionalità. Il loro design elegante valorizza qualsiasi ambiente, mentre la facilità di installazione e il basso consumo energetico li rendono una soluzione pratica, sostenibile e adattabile a qualsiasi tipo di progetto.

Image: MOON models





MOON







Gu-10 included



CODE	MATERIAL	COLOR	PRICE
12300	Aluminium	B ○	21,95€
12301	Aluminium	N ●	21,95€

CODE	MATERIAL	COLOR	PRICE
12310	Aluminium	B ○	26,95€
12311	Aluminium	N ●	26,95€

GU-10 **IP** 20 **220-245V** **Alu** EM    **CE** 

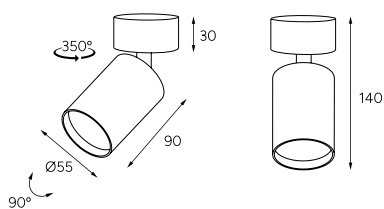
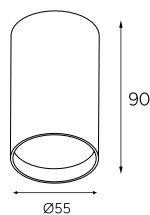

Se recomienda el uso de la lámpara dicroica SMD de 7,5 W (no incluida). Véase página 255
 The use of the 7.5 W SMD dichroic lamp is recommended (not included). See page 255
 L'utilisation de la lampe dichroïque SMD de 7,5 W est recommandée (non incluse). Voir page 255
 Si consiglia l'uso della lampada dicroica SMD da 7,5 W (non inclusa). Vedere pagina 255

downlight superficie



DOWNLIGHTS
SUPERFICIE

SURFACE
DOWNLIGHTS

DOWNLIGHTS
DE SURFACE

DOWNLIGHT DI
SUPERFICIE

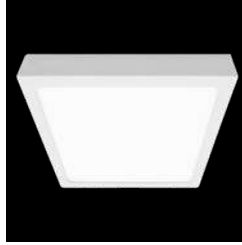
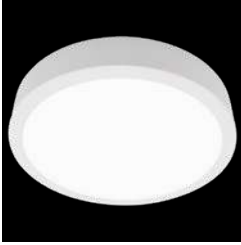

Image: ELSA models
Project: Lyopro Showroom

LEO



3000 - 4000 - 6000K



○ Redondo / Round / Rond / Tondo

□ Cuadrado / Square / Carrè / Quadrato

CODE	W	Lm	K	VERSION	BEAM°	COLOR	DIMMABLE	PRICE
12410	6W	600Lm	3 CCT	○	110	○	ON/OFF	19,95€
12411	12W	1200Lm	3 CCT	○	110	○	ON/OFF	25,95€
12412	18W	1800Lm	3 CCT	○	110	○	ON/OFF	34,95€
12413	24W	2400Lm	3 CCT	○	110	○	ON/OFF	49,95€
12420	6W	600Lm	3 CCT	□	110	○	ON/OFF	19,95€
12421	12W	1200Lm	3 CCT	□	110	○	ON/OFF	25,95€
12422	18W	1800Lm	3 CCT	□	110	○	ON/OFF	34,95€
12423	24W	2400Lm	3 CCT	□	110	○	ON/OFF	49,95€



Cri > 80

6W

12W

18W

24W

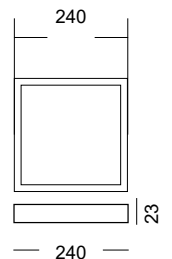
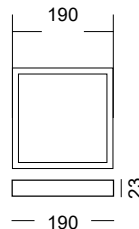
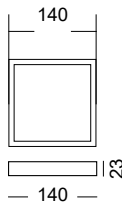
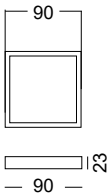
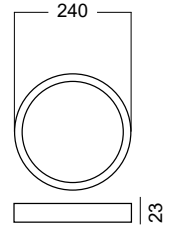
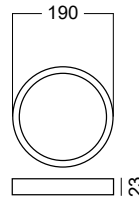
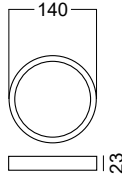
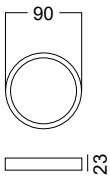

Image: LEO models





Image: ELSA models

ELSA



SUSPENSION KIT

CODE	M	PRICE
60546	1.5 m	21,95€
60547	3 m	23,95€
60548	5 m	25,95€

CODE	W	Lm	K	BEAM°	OUTSIDE	INSIDE	DIMMABLE	PRICE
60500	10W	970Lm	3000K	45	B ○	B ○	SR ON/OFF	76,95€
60501	10W	1000Lm	4000K	45	B ○	N ●		76,95€
60503	10W	970Lm	3000K	45	N ●	PB ○		76,95€
60504	10W	1000Lm	4000K	45	N ●	PM ○		76,95€

CODE	W	Lm	K	BEAM°	OUTSIDE	INSIDE	DIMMABLE	PRICE
60506	20W	1960Lm	3000K	45	B ○	B ○	SR ON/OFF	119,95€
60507	20W	2000Lm	4000K	45	B ○	N ●	A TRIAC	156,95€
60509	20W	1960Lm	3000K	45	N ●	PB ○	C DALI/PUSH	166,95€
60510	20W	2000Lm	4000K	45	N ●	PM ○		

CODE	W	Lm	K	BEAM°	OUTSIDE	INSIDE	DIMMABLE	PRICE
60512	30W	2920Lm	3000K	45	B ○	B ○	SR ON/OFF	169,95€
60513	30W	3000Lm	4000K	45	B ○	N ●	A TRIAC	189,95€
60515	30W	2920Lm	3000K	45	N ●	PB ○	B 1-10V	189,95€
60516	30W	3000Lm	4000K	45	N ●	PM ○	C DALI/PUSH	199,95€

CODE	W	Lm	K	BEAM°	OUTSIDE	INSIDE	DIMMABLE	PRICE
60518	40W	3900Lm	3000K	45	B ○	B ○	SR ON/OFF	229,95€
60519	40W	4000Lm	4000K	45	B ○	N ●	A TRIAC	239,95€
60521	40W	3900Lm	3000K	45	N ●	PB ○	B 1-10V	239,95€
60522	40W	4000Lm	4000K	45	N ●	PM ○	C DALI/PUSH	249,95€



10W



± ø82 ±

20W



± ø115 ±

30W



± ø150 ±

40W



± ø190 ±

ELLEN



☐ Superficie / Surface

CODE	W	Lm	K	VERSION	BEAM°	OUTSIDE	INSIDE	DIMMABLE	PRICE
61400	7W	610Lm	3000K	S ☐	18	N ●	B ○	SR ON/OFF	79,95€
61401	7W	630Lm	4000K		30	N ●	N ●	A TRIAC	109,95€
61403	7W	610Lm	3000K		40	B ○	PB ●	B 1-10V	109,95€
61404	7W	630Lm	4000K			B ○	PM ●	C DALI/PUSH	119,95€
							O ●		

CODE	W	Lm	K	VERSION	BEAM°	OUTSIDE	INSIDE	DIMMABLE	PRICE
61406	12W	1060Lm	3000K	S ☐	15	N ●	B ○	SR ON/OFF	99,95€
61407	12W	1080Lm	4000K		20	N ●	N ●	A TRIAC	129,95€
61409	12W	1060Lm	3000K		30	B ○	PB ●	B 1-10V	129,95€
61410	12W	1080Lm	4000K		40	B ○	PM ●	C DALI/PUSH	139,95€
					50		O ●		

CODE	W	Lm	K	VERSION	BEAM°	OUTSIDE	INSIDE	DIMMABLE	PRICE
61412	20W	1780Lm	3000K	S ☐	15	N ●	B ○	SR ON/OFF	119,95€
61413	20W	1800Lm	4000K		20	N ●	N ●	A TRIAC	149,95€
61415	20W	1780Lm	3000K		45	B ○	PB ●	B 1-10V	149,95€
61416	20W	1800Lm	4000K		55	B ○	PM ●	C DALI/PUSH	159,95€
							O ●		

LUMINUS LED CHIP
HEP LED DRIVER
IP 20
 UGR < 16

 220-240V 50/60Hz
Alu
PC Diffuser
 EM

CE

 -20 / +50
Cri > 90

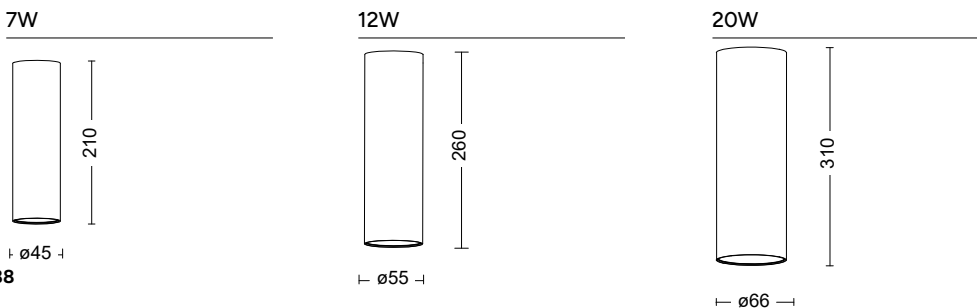





OWEN SUPERFICIE



NEW PRODUCT

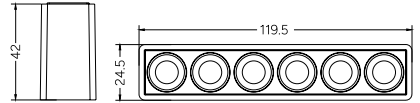

CODE	W	K	Lm	OUTSIDE	INSIDE	BEAM°	DIMMABLE	PRICE
64810	8W	27 2700K	600Lm	B ○	BB ○	26	SR ON/OFF	69,95€
64811	8W	30 3000K	624Lm	N ●	NN ●	38		
		40 4000K	640Lm		BN ●			
					BO ●			
					NO ●			

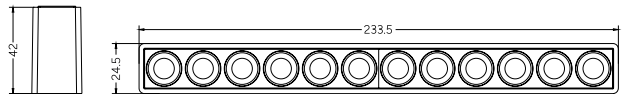
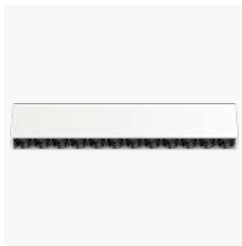

CODE	W	K	Lm	OUTSIDE	INSIDE	BEAM°	DIMMABLE	PRICE
64812	15W	27 2700K	1125Lm	B ○	BB ○	26	SR ON/OFF	99,95€
64813	15W	30 3000K	1170Lm	N ●	NN ●	38		
		40 4000K	1200Lm		BN ●			
					BO ●			
					NO ●			



Image: ORNA models



ORNA SUPERFICIE

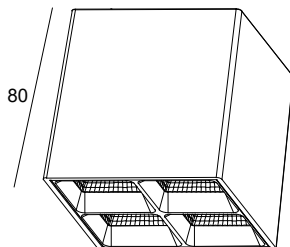
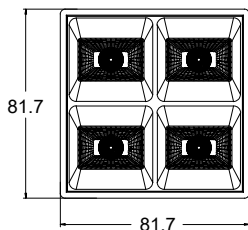

CODE	W	Lm	K	COLOR	BEAM°	DIMMABLE		PRICE
60680	15W	1425Lm	3000K	BN	12	SR	ON/OFF	79,95€
60681	15W	1500Lm	4000K	BN	23	A	TRIAC	99,95€
60686	15W	1425Lm	3000K	N	38			
60687	15W	1500Lm	4000K	N	50			

3570 (35-70)

5050 (50-50)

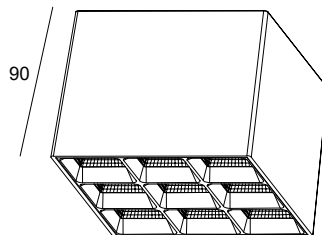

CODE	W	Lm	K	COLOR	BEAM°	DIMMABLE		PRICE
60683	36W	3420Lm	3000K	BN	12	SR	ON/OFF	99,95€
60684	36W	3600Lm	4000K	BN	23	A	TRIAC	129,95€
60689	36W	3420Lm	3000K	N	38	B	1-10V	129,95€
60690	36W	3600Lm	4000K	N	50	C	DALI/PUSH	139,95€

3570 (35-70)

5050 (50-50)

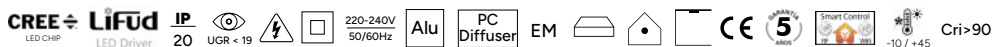

luminaria de suspensión



LUMINARIA DE SUSPENSIÓN

ES_ Una declaración de estilo. Su diseño sofisticado y líneas limpias añaden un toque de elegancia, creando ambientes acogedores y funcionales. Transforma tus espacios con una iluminación que fusiona estética, eficiencia y rendimiento.

PENDANT LUMINAIRES

EN_ A statement of style. Sophisticated design and clean lines add a touch of elegance, creating cosy and functional environments. Transform your spaces with lighting that fuses aesthetics, efficiency and performance.

LUMINAIRES À SUSPENSION

FR_ Une déclaration de style. Son design sophistiqué et ses lignes épurées ajoutent une touche d'élégance, créant des environnements accueillants et fonctionnels. Transformez vos espaces avec un éclairage qui allie esthétique, efficacité et performance.

APPARECCHIO A SOSPENSIONE

IT_ Una dichiarazione di stile. Il suo design sofisticato e le sue linee pulite aggiungono un tocco di eleganza, creando ambienti accoglienti e funzionali. Trasformate i vostri spazi con un'illuminazione che unisce estetica, efficienza e prestazioni.

Image: ELLEN models



ELLEN



Colgante / Pendant / Suspension / Sospensione

CODE	W	Lm	K	VERSION	BEAM°	OUTSIDE	INSIDE	DIMMABLE	PRICE
61400	7W	610Lm	3000K	C	18	N	B	SR ON/OFF	79,95€
61401	7W	630Lm	4000K		30	N	N	A TRIAC	109,95€
61403	7W	610Lm	3000K		40	B	PB	B 1-10V	109,95€
61404	7W	630Lm	4000K			B	PM	C DALI/PUSH	119,95€
							O		

CODE	W	Lm	K	VERSION	BEAM°	OUTSIDE	INSIDE	DIMMABLE	PRICE
61406	12W	1060Lm	3000K	C	15	N	B	SR ON/OFF	99,95€
61407	12W	1080Lm	4000K		20	N	N	A TRIAC	129,95€
61409	12W	1060Lm	3000K		30	B	PB	B 1-10V	129,95€
61410	12W	1080Lm	4000K		40	B	PM	C DALI/PUSH	139,95€
					50		O		

CODE	W	Lm	K	VERSION	BEAM°	OUTSIDE	INSIDE	DIMMABLE	PRICE
61412	20W	1780Lm	3000K	C	15	N	B	SR ON/OFF	119,95€
61413	20W	1800Lm	4000K		20	N	N	A TRIAC	149,95€
61415	20W	1780Lm	3000K		45	B	PB	B 1-10V	149,95€
61416	20W	1800Lm	4000K		55	B	PM	C DALI/PUSH	159,95€
							O		

LUMINUS LED CHIP
HEP LED DRIVER
IP 20
 UGR < 16

 220-240V 50/60Hz
Alu
PC Diffuser
EM

CE
 5 years
 Smart Control
 -20 / +50
Cri > 90

7W

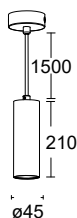

12W

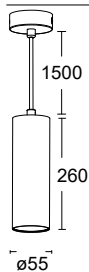

20W

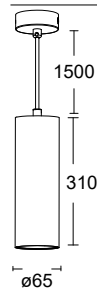

Image: ELLEN 20W models



plafones



PLAFONES

ES_ Su estilo elegante y atemporal lo convierte en un acierto para hogares, oficinas y espacios comerciales, transformándolos en ambientes acogedores que invitan a disfrutar y sentirse cómodo.

CEILING LIGHTS

EN_ Its elegant and timeless style makes it the perfect choice for homes, offices and commercial spaces, transforming them into welcoming environments that invite you to enjoy and feel comfortable.

PLAFONNIERS

FR_ Son style élégant et intemporel en fait le choix idéal pour les maisons, les bureaux et les espaces commerciaux, les transformant en environnements accueillants qui vous invitent à profiter et à vous sentir à l'aise.

PLAFONIERE

IT_ Il suo stile elegante e senza tempo lo rende la scelta perfetta per case, uffici e spazi commerciali, trasformandoli in ambienti accoglienti che invitano a divertirsi e a sentirsi a proprio agio.

Image: HADES models



HADES



2700 - 3000 - 4000K



CODE	W	Lm	K	BEAM°	COLOR	DIMMABLE	PRICE
63680	42W	3780Lm	3 CCT	120	B ○	ON/OFF	159,95€
63681	42W	3780Lm	3 CCT	120	N ●	ON/OFF	169,95€
63682	42W	3780Lm	3 CCT	120	BO ◐	ON/OFF	179,95€
63683	42W	3780Lm	3 CCT	120	NO ◑	ON/OFF	179,95€
63685	72W	6480Lm	3 CCT	120	B ○	ON/OFF	279,95€
63686	72W	6480Lm	3 CCT	120	N ●	ON/OFF	289,95€
63687	72W	6480Lm	3 CCT	120	BO ◐	ON/OFF	299,95€
63688	72W	6480Lm	3 CCT	120	NO ◑	ON/OFF	299,95€
63780	42W	3780Lm	3 CCT	120	B ○	DALI/PUSH	219,95€
63781	42W	3780Lm	3 CCT	120	N ●	DALI/PUSH	229,95€
63782	42W	3780Lm	3 CCT	120	BO ◐	DALI/PUSH	239,95€
63783	42W	3780Lm	3 CCT	120	NO ◑	DALI/PUSH	239,95€
63785	72W	6480Lm	3 CCT	120	B ○	DALI/PUSH	379,95€
63786	72W	6480Lm	3 CCT	120	N ●	DALI/PUSH	389,95€
63787	72W	6480Lm	3 CCT	120	BO ◐	DALI/PUSH	399,95€
63788	72W	6480Lm	3 CCT	120	NO ◑	DALI/PUSH	399,95€



220-240V
50/60Hz



EM



Cri > 80

42W

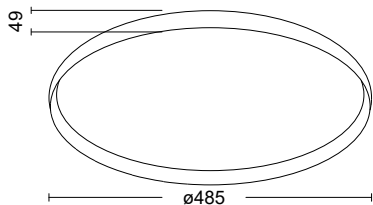

100

72W

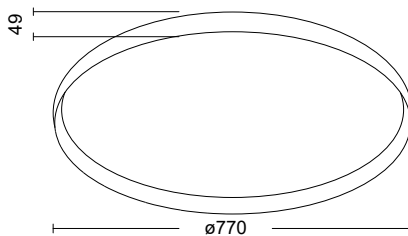

HADES



2700 - 3000 - 4000K

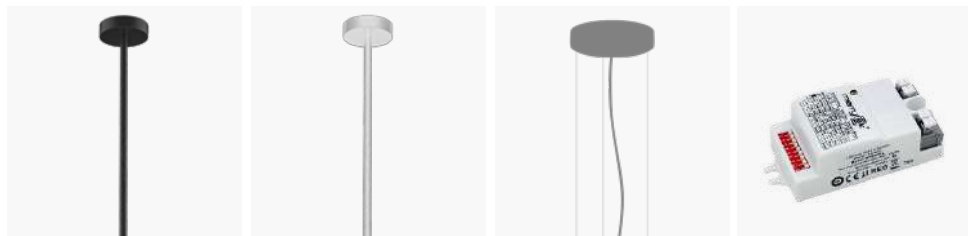

CODE <small>72W</small>	METRES	PRICE	CODE <small>42W</small>	METRES	PRICE	CODE	METRES	PRICE	CODE <small>MOTION SENSOR</small>	PRICE
63697	○ 1.2 m	89,95€	63692	○ 0,6-1,2 m	54,95€	63690	1.5 m	19,95€	63695	19,95€
63698	● 1.2 m	89,95€	63693	● 0,6-1,2 m	54,95€					

El **servicio de montaje** conlleva un coste adicional. Consulta pag 492. / The **assembly service** carries an additional cost. See page 492. / Le **service de montage** entraîne un coût supplémentaire. Voir page 492. / Il **servizio di montaggio** comporta un costo aggiuntivo. Consulta pagina 492.

Image: HADES models



linear light



ES_ Diseñados para quienes buscan un estilo limpio y moderno, aportan una iluminación discreta sin renunciar al rendimiento. Gracias a sus dimensiones reducidas, se integran de manera armoniosa en cualquier espacio sin acaparar atención. Un equilibrio entre funcionalidad, estética y comodidad visual.

EN_ Designed for those seeking a clean, modern style, they provide discreet lighting without sacrificing performance. Thanks to their reduced dimensions, they blend harmoniously into any space without drawing attention to themselves. A balance between functionality, aesthetics and visual comfort.

FR_ Conçues pour ceux Conçues pour ceux qui recherchent un style épuré et moderne, elles offrent un éclairage discret sans sacrifier les performances. Grâce à leurs dimensions réduites, elles s'intègrent harmonieusement dans tout espace sans attirer l'attention. Un équilibre entre fonctionnalité, esthétique et confort visuel.

IT_ Progettati per chi cerca uno stile pulito e moderno, forniscono un'illuminazione discreta senza rinunciare alle prestazioni. Grazie alle loro dimensioni ridotte, si integrano armoniosamente in ogni spazio senza attirare l'attenzione. Un equilibrio tra funzionalità, estetica e comfort visivo.

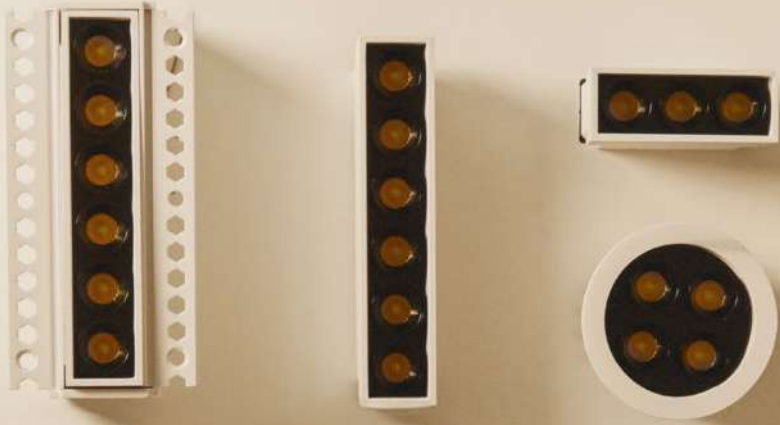

The balance between functionality, aesthetics, and visual comfort.

Image: OWEN models



**Descubre cómo
transformar
tus espacios.**



OWEN

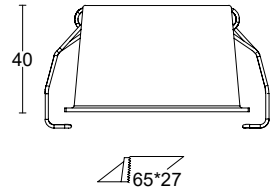
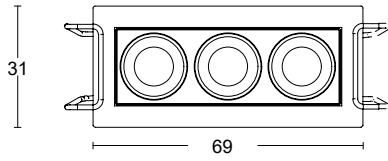

CODE	W	K	Lm	OUTSIDE	INSIDE	BEAM°	DIMMABLE	PRICE
64800	6W	27 2700K	450Lm	B ○	BB ○	26	SR ON/OFF	34,95€
64801	6W	30 3000K	468Lm	N ●	NN ●	38	A TRIAC	74,95€
		40 4000K	480Lm		BN ●		B 1-10V	74,95€
					BO ●		C DALI/PUSH	84,95€
					NO ●			

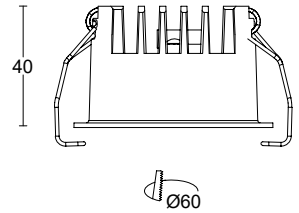
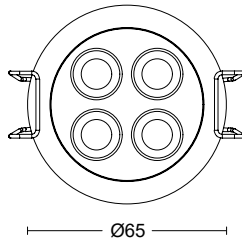

CODE	W	K	Lm	OUTSIDE	INSIDE	BEAM°	DIMMABLE	PRICE
64802	8W	27 2700K	600Lm	B ○	BB ○	26	SR ON/OFF	39,95€
64803	8W	30 3000K	624Lm	N ●	NN ●	38	A TRIAC	79,95€
		40 4000K	640Lm		BN ●		B 1-10V	79,95€
					BO ●		C DALI/PUSH	89,95€
					NO ●			





OWEN

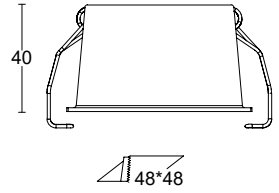
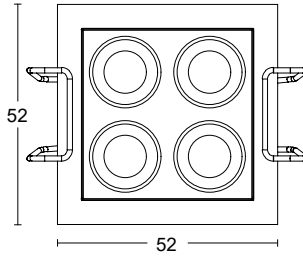

CODE	W	K	Lm	OUTSIDE	INSIDE	BEAM°	DIMMABLE	PRICE
64804	8W	27 2700K	600Lm	B ○	BB ○	26	SR ON/OFF	39,95€
64805	8W	30 3000K	624Lm	N ●	NN ●	38	A TRIAC	79,95€
		40 4000K	640Lm		BN ●		B 1-10V	79,95€
					BO ●		C DALI/PUSH	89,95€
					NO ●			

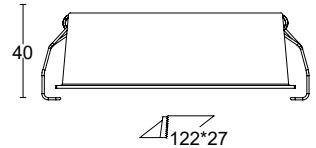
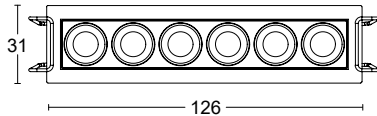

CODE	W	K	Lm	OUTSIDE	INSIDE	BEAM°	DIMMABLE	PRICE
64806	10W	27 2700K	750Lm	B ○	BB ○	26	SR ON/OFF	59,95€
64807	10W	30 3000K	780Lm	N ●	NN ●	38	A TRIAC	99,95€
		40 4000K	800Lm		BN ●		B 1-10V	99,95€
					BO ●		C DALI/PUSH	109,95€
					NO ●			

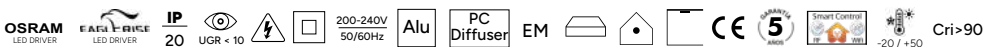

OWEN



CODE	W	K	Lm	OUTSIDE	INSIDE	BEAM°	DIMMABLE	PRICE
64808	20W	27 2700K	1500Lm	B ○	BB ○	26	SR ON/OFF	99,95€
64809	20W	30 3000K	1560Lm	N ●	NN ●	38	A TRIAC	139,95€
		40 4000K	1600Lm		BN ●		B 1-10V	139,95€
					BO ●		C DALI/PUSH	149,95€
					NO ●			

200-240V 50/60Hz

 EM

 -20 / +50

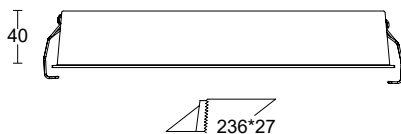
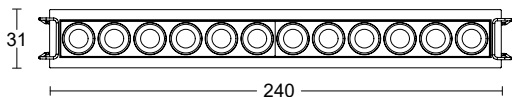
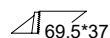
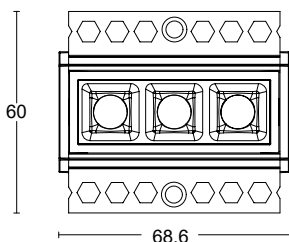

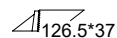
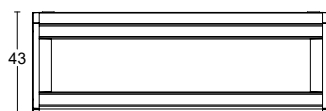
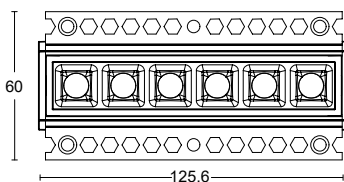

Image: OWEN models

OWEN TRIMLESS



CODE	W	K	Lm	OUTSIDE	INSIDE	BEAM°	DIMMABLE	PRICE
64820	6W	27 2700K	450Lm	B ○	BB ○	26	SR ON/OFF	44,95€
64821	6W	30 3000K	468Lm	N ●	NN ●	38	A TRIAC	84,95€
		40 4000K	480Lm		BN ●		B 1-10V	84,95€
					BO ●		C DALI/PUSH	94,95€
					NO ●			



CODE	W	K	Lm	OUTSIDE	INSIDE	BEAM°	DIMMABLE	PRICE
64822	10W	27 2700K	750Lm	B ○	BB ○	26	SR ON/OFF	64,95€
64823	10W	30 3000K	780Lm	N ●	NN ●	38	A TRIAC	109,95€
		40 4000K	800Lm		BN ●		B 1-10V	109,95€
					BO ●		C DALI/PUSH	119,95€
					NO ●			

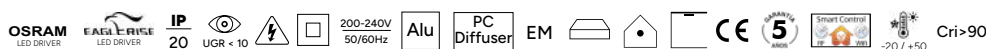

OWEN TRIMLESS



CODE	W	K	Lm	OUTSIDE	INSIDE	BEAM°	DIMMABLE	PRICE
64824	20W	27 2700K	1500Lm	B	BB	26	SR ON/OFF	109,95€
64825	20W	30 3000K	1560Lm	N	NN	38	A TRIAC	159,95€
		40 4000K	1600Lm		BN		B 1-10V	159,95€
					BO		C DALI/PUSH	169,95€
					NO			

Cri > 90

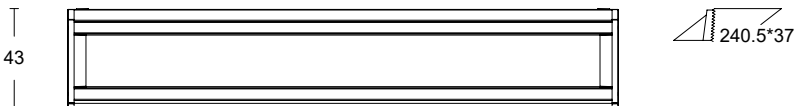
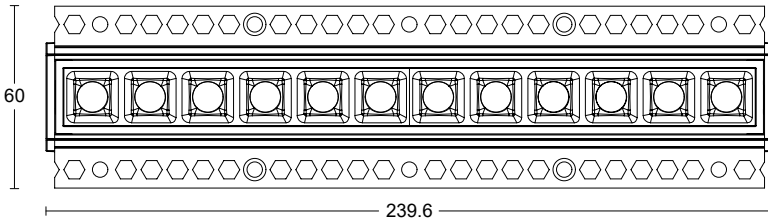



OWEN TILT

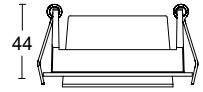
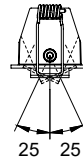
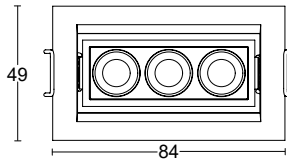

CODE	W	K	Lm	OUTSIDE	INSIDE	BEAM°	DIMMABLE	PRICE
64830	6W	27 2700K	450Lm	B ○	BB ○	26	SR ON/OFF	44,95€
64831	6W	30 3000K	468Lm	N ●	NN ●	38	A TRIAC	84,95€
		40 4000K	480Lm		BN ●		B 1-10V	84,95€
					BO ●		C DALI/PUSH	94,95€
					NO ●			

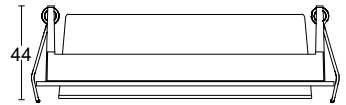
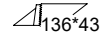
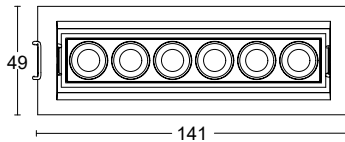

CODE	W	K	Lm	OUTSIDE	INSIDE	BEAM°	DIMMABLE	PRICE
64832	10W	27 2700K	750Lm	B ○	BB ○	26	SR ON/OFF	64,95€
64833	10W	30 3000K	780Lm	N ●	NN ●	38	A TRIAC	109,95€
		40 4000K	800Lm		BN ●		B 1-10V	109,95€
					BO ●		C DALI/PUSH	119,95€
					NO ●			



OWEN TILT

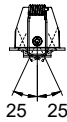

CODE	W	K	Lm	OUTSIDE	INSIDE	BEAM°	DIMMABLE	PRICE	
64834	20W	27 2700K	1500Lm	B ○	BB ○	26	SR ON/OFF	109,95€	
64835	20W	30 3000K	1560Lm	N ●	NN ●	38	A TRIAC	159,95€	
		40 4000K	1600Lm		BN ●		B 1-10V	159,95€	
						BO ●		C DALI/PUSH	169,95€
						NO ●			

OSRAM LED DRIVER **FAELT EDGE** LED DRIVER **IP** 20 **UGR < 10** **200-240V** 50/60Hz **Alu** **PC Diffuser** **EM** **CE** **5** **Smart Control** **-20 / +50** **Cri > 90**

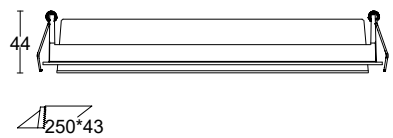
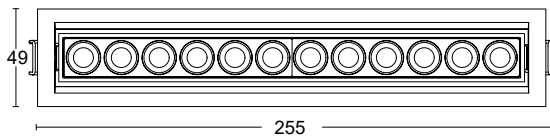



Image: Diffuser colors of oven models

DIFFUSER COLORS FOR OWEN



OUTSIDE INSIDE
 B ○ BB ○



OUTSIDE INSIDE
 N ● BB ○



OUTSIDE INSIDE
 B ○ NN ●



OUTSIDE INSIDE
 N ● NN ●



OUTSIDE INSIDE
 B ○ BN ●



OUTSIDE INSIDE
 N ● BN ●

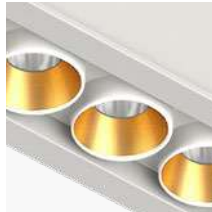

OUTSIDE INSIDE
 B ○ BO ●

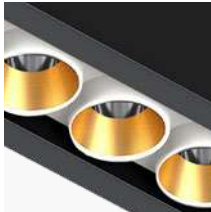

OUTSIDE INSIDE
 N ● BO ●



OUTSIDE INSIDE
 B ○ NO ●



OUTSIDE INSIDE
 N ● NO ●



ORNA

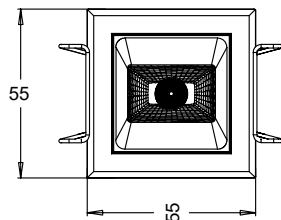
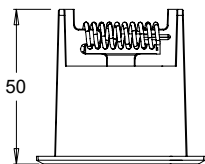

CODE	W	Lm	K	COLOR	BEAM°	DIMMABLE		PRICE
60600	5W	475Lm	3000K	BN	12	SR	ON/OFF	29,95€
60601	5W	500Lm	4000K	BN	23	A	TRIAC	69,95€
60650	5W	475Lm	3000K	N	38	B	1-10V	69,95€
60651	5W	500Lm	4000K	N	50	C	DALI/PUSH	79,95€

3570 (35-70)

5050 (50-50)

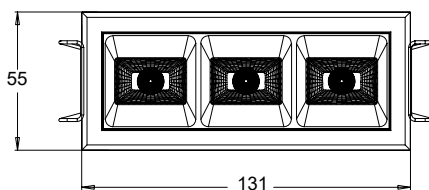
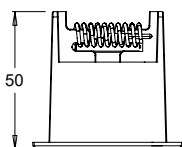

CODE	W	Lm	K	COLOR	BEAM°	DIMMABLE		PRICE
60603	12W	1140Lm	3000K	BN	12	SR	ON/OFF	59,95€
60604	12W	1200Lm	4000K	BN	23	A	TRIAC	89,95€
60653	12W	1140Lm	3000K	N	38	B	1-10V	89,95€
60654	12W	1200Lm	4000K	N	50	C	DALI/PUSH	99,95€

3570 (35-70)

5050 (50-50)

W (Wallwasher)



ORNA

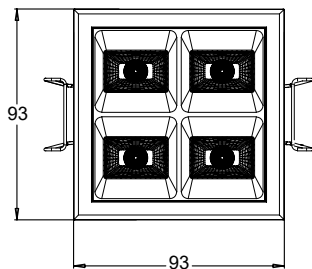
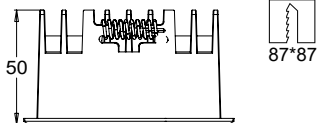

CODE	W	Lm	K	COLOR	BEAM°	DIMMABLE	PRICE
60606	15W	1425Lm	3000K	BN	12	SR ON/OFF	79,95€
60607	15W	1500Lm	4000K	BN	23	A TRIAC	109,95€
60656	15W	1425Lm	3000K	N	38	B 1-10V	109,95€
60657	15W	1500Lm	4000K	N	50	C DALI/PUSH	119,95€
3570 (35-70)							
5050 (50-50)							

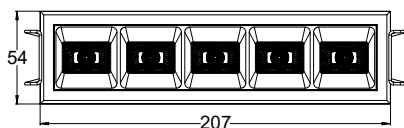
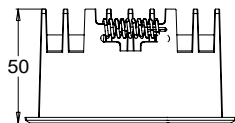

CODE	W	Lm	K	COLOR	BEAM°	DIMMABLE	PRICE
60609	20W	1900Lm	3000K	BN	12	SR ON/OFF	99,95€
60610	20W	2000Lm	4000K	BN	23	A TRIAC	119,95€
60659	20W	1900Lm	3000K	N	38	B 1-10V	119,95€
60660	20W	2000Lm	4000K	N	50	C DALI/PUSH	129,95€
3570 (35-70)							
5050 (50-50)							
W (Wallwasher)							



ORNA

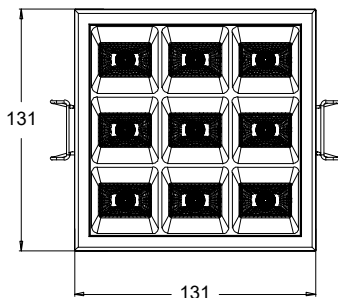
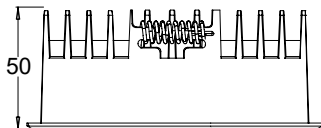

CODE	W	Lm	K	COLOR	BEAM°	DIMMABLE		PRICE
60640	36W	3420Lm	3000K	BN	12	SR	ON/OFF	119,95€
60641	36W	3600Lm	4000K	BN	23	A	TRIAC	149,95€
60670	36W	3420Lm	3000K	N	38	B	1-10V	149,95€
60671	36W	3600Lm	4000K	N	50	C	DALI/PUSH	159,95€

3570 (35-70)

5050 (50-50)

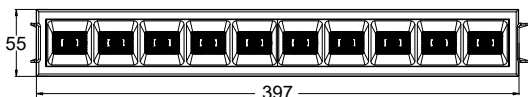
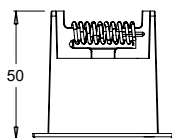
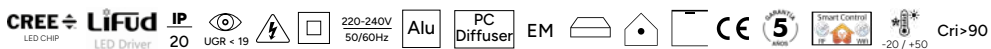

CODE	W	Lm	K	COLOR	BEAM°	DIMMABLE		PRICE
60643	40W	3800Lm	3000K	BN	12	SR	ON/OFF	129,95€
60644	40W	4000Lm	4000K	BN	23	A	TRIAC	159,95€
60673	40W	3800Lm	3000K	N	38	B	1-10V	159,95€
60674	40W	4000Lm	4000K	N	50	C	DALI/PUSH	169,95€

3570 (35-70)

5050 (50-50)

W (Wallwasher)

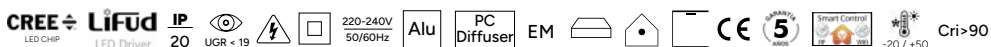

luminaria de escayola



LUMINARIA DE
ESCAYOLA

PLASTER
LUMINAIRES

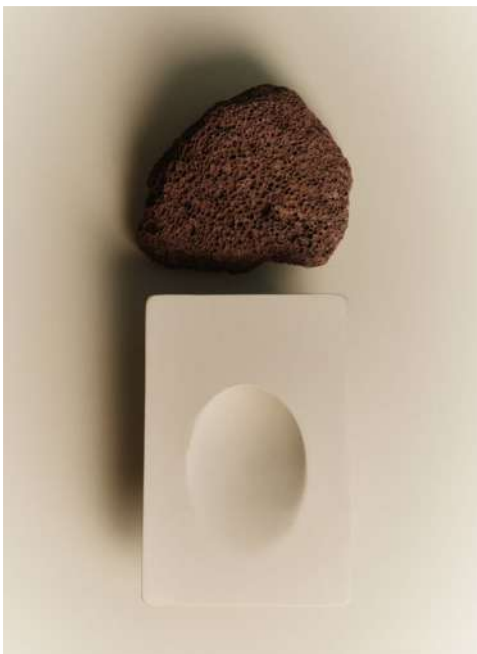

LUMINAIRES EN
PLÂTE

APPARECCHIO IN
GESSO

ES_ El diseño que se integran perfectamente en tu espacio. EN_ The design that integrates perfectly into your space. FR_ Le design qui s'intègre parfaitement à votre espace. IT_ Il design che si integra perfettamente nel vostro spazio.

Image: KIAT design



LEK



Gu-10 included

Accesorios disponibles página 255
 Accessories available page 255
 Accessoires disponibles à la page 255
 Accessori disponibili a pagina 255

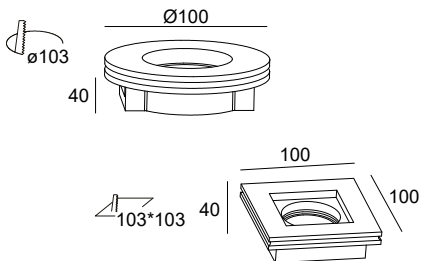

○ Redondo / Round / Rond / Tondo

□ Cuadrado / Square / Carré / Quadrato

CODE	LAMP	MATERIAL	VERSION	COLOR	PRICE
60135	GU-10	Yeso / Gypsum / Gypse / Gesso	○	○	12,95€
60136	GU-10	Yeso / Gypsum / Gypse / Gesso	□	○	12,95€

*Lamp not included



LITAS



Gu-10 included

Accesorios disponibles página 255
 Accessories available page 255
 Accessoires disponibles à la page 255
 Accessori disponibili a pagina 255

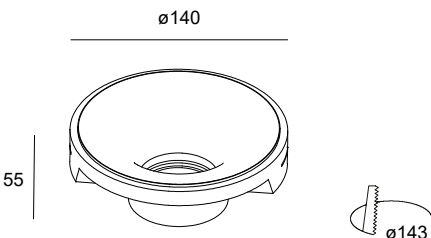

○ Redondo / Round / Rond / Tondo

CODE	LAMP	MATERIAL	COLOR	PRICE
60143	GU-10	Yeso / Gypsum / Gypse / Gesso	○	14,95€

*Lamp not included

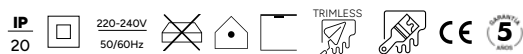

Image: LEK & LITAS models



KIAT



Gu-10 included



□ Cuadrado / Square /
Asymétrique / Asimmetrico



◻ Cuadrado asimétrico
Asymmetric square
Carré asymétrique
Quadrato asimmetrico



◻ Rectangular
Rectangulaire
Rettangolare

CODE	LAMP	MATERIAL	VERSION	COLOR	PRICE
60137	GU-10	Yeso / Gypsum / Gypse / Gesso	○	○	13,45€
60138	GU-10	Yeso / Gypsum / Gypse / Gesso	◻	○	13,45€
60139	2xGU-10	Yeso / Gypsum / Gypse / Gesso	◻	○	25,25€

*Lamp not included

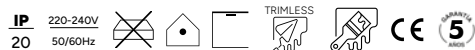

SQUARE

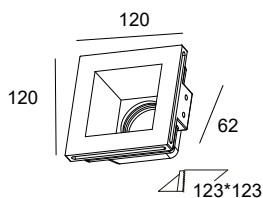

A. SQUARE

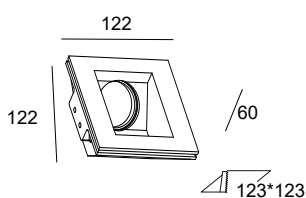

RECTANGULAR

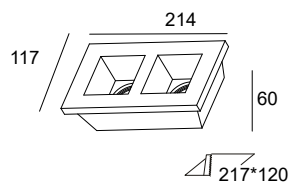

Se recomienda el uso de la lámpara dicróica SMD de 7,5 W (no incluida). Véase página 255
 The use of the 7.5 W SMD dichroic lamp is recommended (not included). See page 255
 L'utilisation de la lampe dichroïque SMD de 7,5 W est recommandée (non incluse). Voir page 255
 Si consiglia l'uso della lampada dicroica SMD da 7,5 W (non inclusa). Vedere pagina 255

WAT

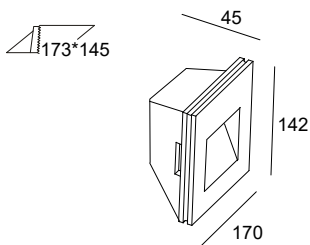

CODE	W	Lm	K	BEAM	COLOR	PRICE
60149	1W	90Lm	2700K	100	○	49,95€
60150	1W	95Lm	3000K	100	○	49,95€
60151	1W	100Lm	4000K	100	○	49,95€

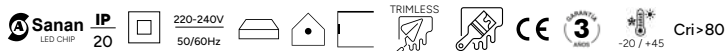

DIRHAM



Gu-10 included

Accesorios disponibles página 255
 Accessories available page 255
 Accessoires disponibles à la page 255
 Accessori disponibili a pagina 255

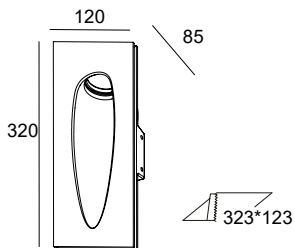

CODE	LAMP	MATERIAL	COLOR	PRICE
60159	GU-10	Yeso / Gypsum / Gypse / Gesso	○	69,95€

*Lamp not included

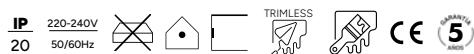

TAKA

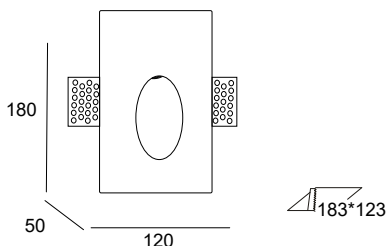
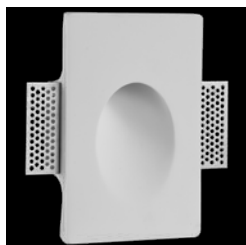

CODE	W	Lm	K	BEAM	COLOR	PRICE
60155	1W	90Lm	2700K	100	○	47,95€
60156	1W	95Lm	3000K	100	○	47,95€
60157	1W	100Lm	4000K	100	○	47,95€

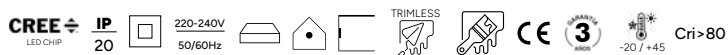

YUAN

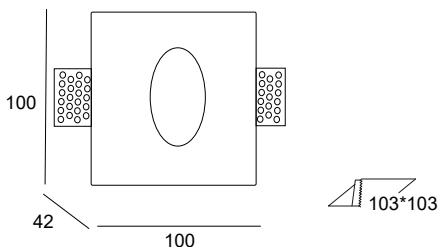
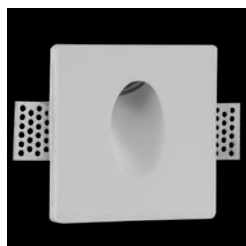

CODE	W	Lm	K	BEAM	COLOR	PRICE
60152	1W	90Lm	2700K	100	○	44,95€
60153	1W	95Lm	3000K	100	○	44,95€
60154	1W	100Lm	4000K	100	○	44,95€

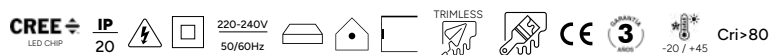

DONG

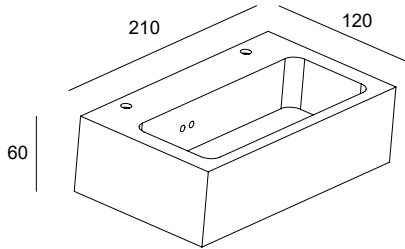

CODE	LAMP	MATERIAL	COLOR	PRICE
60181	E-14	Yeso / Gypsum / Gypse / Gesso	○	54,95€

*Lamp not included



luminaria de carril 230V



LUMINARIA
DE CARRIL

TRACK
LUMINAIRES



LUMINAIRES
SUR RAIL

PROIETTORE
PER BINARIO



Image: ARIES 10W models
Project: Retail store Patraix, Valencia



MOON



Gu-10 included



CODE	MATERIAL	COLOR	PRICE
12330	Aluminium	B ○	36,95€
12331	Aluminium	N ●	36,95€

GU-10 TRIFÁSICO IP 20 220-245V 50/60Hz Alu EM   CE 

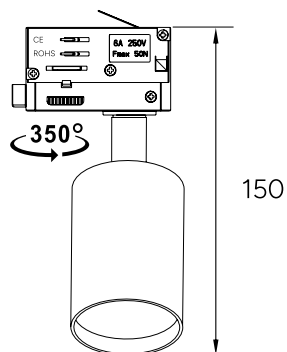
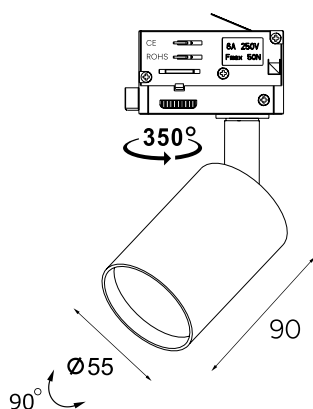

Se recomienda el uso de la lámpara dicróica SMD de 7,5 W (no incluida). Véase página 255
 The use of the 7.5 W SMD dichroic lamp is recommended (not included). See page 255
 L'utilisation de la lampe dichroïque SMD de 7,5 W est recommandée (non incluse). Voir page 255
 Si consiglia l'uso della lampada dicroica SMD da 7,5 W (non inclusa). Vedere pagina 255

ARIES



2700 - 3000 - 4000K



CODE	W	Lm	K	BEAM°	COLOR	DIMMABLE	PRICE
61550	10W	1200Lm	3 CCT	15	B ○	ON/OFF	79,95€
61551	10W	1200Lm	3 CCT	24	N ●	ON/OFF	79,95€
61552	20W	2400Lm	3 CCT	38	B ○	ON/OFF	109,95€
61553	20W	2400Lm	3 CCT	45	N ●	ON/OFF	109,95€
61554	30W	3600Lm	3 CCT	60	B ○	ON/OFF	129,95€
61555	30W	3600Lm	3 CCT		N ●	ON/OFF	129,95€
61584	30W	3600Lm	3 CCT		B ○	DALI/PUSH	219,95€
61585	30W	3600Lm	3 CCT		N ●	DALI/PUSH	219,95€

OSRAM
LED DRIVER

ALOKING
LED DRIVER

TRIFASICO

UGR < 19

IP
20



220-240V
50/60Hz

Alu



-30 / +50

Cri > 90

10W

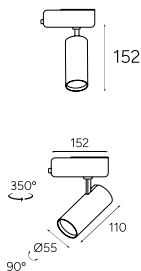

20W

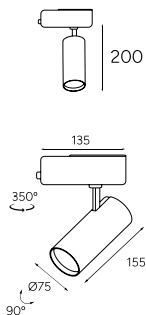

30W

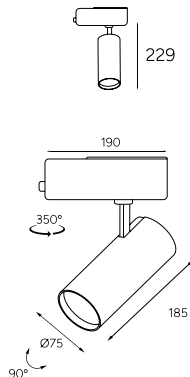

track system



ES_ Un diseño que te permite ajustar y reconfigurar las luminarias según las necesidades específicas de tu ambiente. Perfecto para destacar áreas particulares o crear atmósferas dinámicas, este sistema se adapta a cualquier proyecto.

EN_ A design that allows you to adjust and reconfigure the luminaires according to the specific needs of your environment. Perfect for highlighting particular areas or creating dynamic atmospheres, this system adapts to any project.

FR_ Une conception qui vous permet d'ajuster et de reconfigurer les luminaires en fonction des besoins spécifiques de votre environnement. Parfait pour mettre en valeur des zones particulières ou créer des atmosphères dynamiques, ce système s'adapte à tous les projets.

IT_ Un design che consente di regolare e riconfigurare gli apparecchi in base alle esigenze specifiche dell'ambiente. Perfetto per evidenziare aree particolari o creare atmosfere dinamiche, questo sistema si adatta a qualsiasi progetto.



Image: ARIES models
Project: Residential Project, Sant Cugat, Barcelona

TRACK SYSTEM TRIFÁSICO

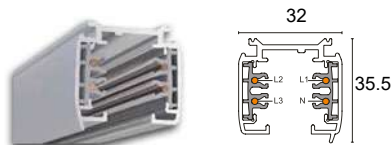

Carril trifásico superficie 1 m / Three-phase surface rail 1 m / Surface du rail triphasé 1 m / Superficie rotaia trifase 1 m

● 62496 ○ 62497 32,95€

Carril trifásico superficie 2 m / Three-phase surface rail 2 m / Surface du rail triphasé 2 m / Superficie rotaia trifase 2 m

● 62504 ○ 62506 64,95€

ACCESORIOS / ACCESSORIES / ACCESSOIRES / ACCESSORI



Alimentador tierra a izquierda / Ground feeder left / Alimentateur au sol gauche / Alimentatore a terra a sinistra

● 62510 ○ 62511 9,95€



Alimentador tierra a derecha / Feeder earth right / Terre d'alimentation droite / Messa a terra dell'alimentatore a destra

● 62512 ○ 62513 9,95€



Unión eléctrica / Electrical connection / Raccordement électrique / Collegamento elettrico

● 62514 ○ 62515 7,95€



Unión eléctrica central / Central electrical junction / Jonction électrique centrale / Giunzione elettrica centrale

● 62518 ○ 62519 14,95€

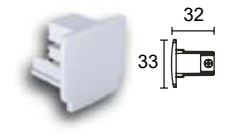

Tapa final / End cap / Capuchon d'extrémité / Tappo terminale

● 62786 ○ 62787 1,45€



Conector flexible / Flexible connector / Connecteur flexible / Connettore flessibile

● 62520 ○ 62521 19,95€



Conector ajustable / Adjustable connector / Connecteur réglable / Connettore regolabile

● 62522 ○ 62523 18,95€



Conector en X / X-connector / Connecteur en X / Connettore a X

● 62524 ○ 62525 24,95€



Conector en L izquierda / L-connector left / Connecteur en L gauche / Connettore a L sinistro

● 62534 ○ 62535 14,95€

TRACK SYSTEM TRIFÁSICO



Conector en T derecha /
L-connector right /
Connecteur en L droit /
Connettore a L destro

● 62536 ○ 62537 14,95€



Conector en T izquierda /
T-connector left / Connecteur
en T gauche / Connettore a
T sinistro

● 62538 ○ 62539 17,95€



Conector en T izquierda 2 /
T-connector left 2 /
Connecteur en T gauche 2 /
Connettore a T sinistro 2

● 62540 ○ 62541 17,95€



Conector en T derecha /
T-connector right /
Connecteur en T droit /
Connettore a T destro

● 62542 ○ 62543 17,95€



Conector en T derecha 2 /
T-connector right 2 /
Connecteur en T droit 2 /
Connettore a T destro 2

● 62544 ○ 62545 17,95€



Kit suspensión 2 m /
Suspension kit 2 m / Kit de
suspension 2 m / Kit di
sospensione 2 m

● 62694 ○ 62695 9,95€



Abrazadera de refuerzo carril
/ Rail reinforcement clamp /
Pince de renforcement du rail
/ Morsetto di rinforzo del track

● 62701 ○ 62702 9,95€

TRACK SYSTEM TRIFÁSICO DALI

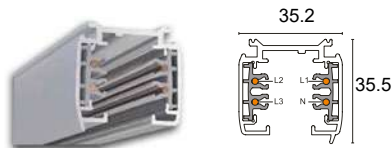

Carril trifásico superficie 1 m / Three-phase surface rail 1 m / Surface du rail triphasé 1 m / Superficie rotaia trifase 1 m

● 62396 ○ 62397 59,95€

Carril trifásico superficie 2 m / Three-phase surface rail 2 m / Surface du rail triphasé 2 m / Superficie rotaia trifase 2 m

● 62404 ○ 62406 119,95€

ACCESORIOS / ACCESSORIES / ACCESSOIRES / ACCESORI

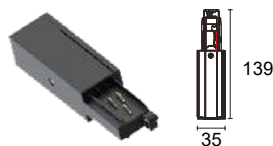

Alimentador tierra a izquierda / Ground feeder left / Alimentateur au sol gauche / Alimentatore a terra a sinistra

● 62410 ○ 62411 22,95€

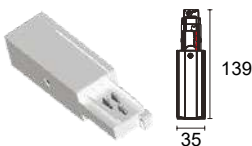

Alimentador tierra a derecha / Feeder earth right / Terre d'alimentation droite / Messa a terra dell'alimentatore a destra

● 62412 ○ 62413 22,95€

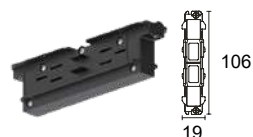

Unión eléctrica / Electrical connection / Raccordement électrique / Collegamento elettrico

● 62414 ○ 62415 15,95€



Unión eléctrica central / Central electrical junction / Jonction électrique centrale / Giunzione elettrica centrale

● 62418 ○ 62419 39,95€



Tapa final / End cap / Capuchon d'extrémité / Tappo terminale

● 62526 ○ 62527 1,45€



Conector flexible / Flexible connector / Connecteur flexible / Connettore flessibile

● 62420 ○ 62421 55,95€

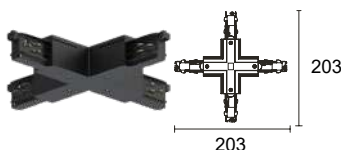

Conector en X / X-connector / Connecteur en X / Connettore a X

● 62430 ○ 62431 86,95€

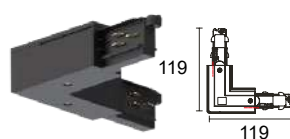

Conector en L tierra exterior / External earth L-connector / Terre externe / Connettore a L terra esterna

● 62424 ○ 62425 47,95€

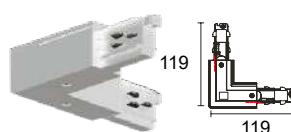

Conector en L tierra interior / Inner earth L-connector / Connettore en L de terre intérieure / Connettore a L terra interna

● 62422 ○ 62423 47,95€

TRACK SYSTEM TRIFÁSICO DALI



Conector en T izquierda /
T-connector left / Connecteur
en T gauche / Connettore a
T sinistro

● 62428 ○ 62429 73,95€



Conector en T izquierda 2 /
T-connector left 2 /
Connecteur en T gauche 2 /
Connettore a T sinistro 2

● 62478 ○ 62479 73,95€



Conector en T derecha /
T-connector right /
Connecteur en T droit /
Connettore a T destro

● 62426 ○ 62427 73,95€



Conector en T derecha 2 /
T-connector right 2 /
Connecteur en T droit 2 /
Connettore a T destro 2

● 62476 ○ 62477 73,95€

track light system 48V

MARKO

ES_ Un sistema de iluminación versátil que lleva el concepto de carril a un nuevo nivel. EN_ A versatile lighting system that takes the concept of the light rail to a new level. FR_ Un système d'éclairage polyvalent qui porte le concept du rail léger à un niveau supérieur. IT_ Un sistema di illuminazione versatile che porta il concetto di binario luminoso a un nuovo livello.

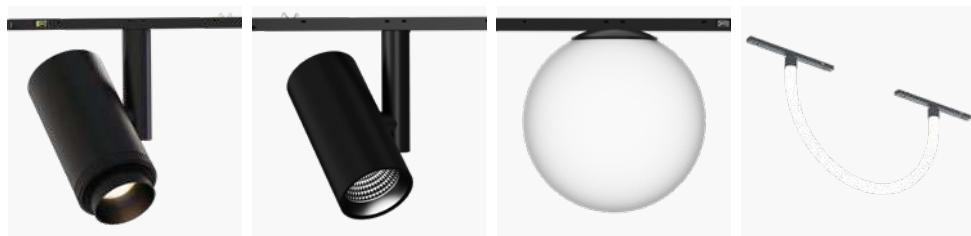

CARRIL
48V

TRACK LIGHT
SYSTEM 48V

SYSTÈME D'ÉCLAIRAGE
SUR RAIL 48V

SISTEMA DI
ILLUMINAZIONE A
BINARIO 48V



ES_ Minimalismo, precisión y control en una sola línea de luz continua para crear composiciones a tu medida.

EN_ Minimalism, precision and control in a single continuous line of light to create lighting compositions tailored to your space.

FR_ Minimalisme, précision et contrôle dans une seule ligne de lumière continue pour créer des compositions lumineuses sur mesure.

IT_ Minimalismo, precisione e controllo in un'unica linea di luce continua per creare composizioni di luce su misura.

CARRILES 48V

ES_ Todos los carriles y correas son compatibles con DALI y ON/OFF. EN_ All rails and belts are DALI and ON/OFF compatible. FR_ Tous les rails et courroies sont compatibles DALI et ON/OFF. IT_ Tutti i binari e le cinghie sono compatibili con DALI e ON/OFF.



*Carril 48 V empotrar 1-2m /
Recessed 1-2m / Rail encastré 1-2m
/ Binario da incasso 1-2m

● 66301	1m	34,95€
● 66321	2m	69,95€

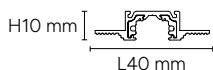

*Carril 48 V empotrar trimless 1-2m /
Recessed trimless 1-2m / Rail encastré
trimless 1-2m / Binario da incasso trimless
1-2m

● 66303	1m	29,95€
● 66323	2m	59,95€

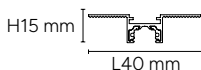

*Carril 48 V superficie 1-2m /
Surface 1-2m / Rail de surface 1-2m
/ Binario di superficie 1-2m

● 66305		24,95€
● 66325		49,95€

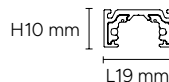

ES_ Longitud máxima del carril: 35 m. Potencia máxima: 300W. EN_ Up to 35 meters of track length and a maximum power of 300W. FR_ Jusqu'à 35 mètres de rail et une puissance maximale de 300W. IT_ Fino a 35 metri di binario e una potenza massima di 300W.



*Tapas finales incluidas / End caps included / Embouts inclus / Tappi terminali inclusi





Image: 48V rail accessories

ACCESORIOS CARRIL 48V



Conector horizontal 90° / 90° conner connector / Connecteur horizontal à 90 / Connettore orizzontale a 90°

● 66341 22,95€

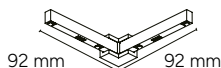

Conector vertical 90° / 90° vertical connector / Connecteur vertical à 90 / Connettore verticale a 90°

● 66343 22,95€

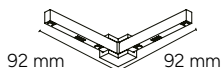

Conector alimentación entrada / Input power connector / Connecteur d'alimentation d'entrée / Connettore di alimentazione in ingresso

● 66331 19,95€

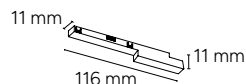

Adaptador curvo / Curve track adapter / Adaptateur de voie de courbe / Adattatore per binario curvo

● 66333 19,95€



Adaptador recto / Regular track adapter / Adaptateur pour voie normale / Adattatore per binari normali

● 66335 14,95€



Unión electrica recto / Power connector / Connecteur d'alimentation / Connettore di alimentazione

● 66337 22,95€



Kit suspensión regulable 3 m negro / Suspension kit for adjustable 3 m track Black / Kit de suspension pour rail réglable 3 m Noir / Kit di sospensione per binario regolabile 3 m Nero

● 66359 14,95€



Fuentes de alimentación 48V / Power supplies 48V / Alimentation électrique 48V / Alimentazione 48V

Page 452

CORREAS 48V

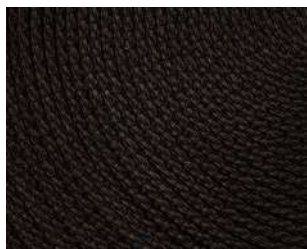

Correa de instalación / Belt / Bande d'installation / Cinghia di montaggio

● 66308 19,95€



Correa de instalación / Belt / Bande d'installation / Cinghia di montaggio

● 66309 19,95€



Correa de instalación / Belt / Bande d'installation / Cinghia di montaggio

● 66310 19,95€

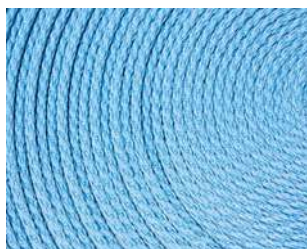

Correa de instalación / Belt / Bande d'installation / Cinghia di montaggio

● 66311 19,95€



Correa de instalación / Belt / Bande d'installation / Cinghia di montaggio

● 66312 19,95€



ES_ Todos los carriles y correas son compatibles con DALI y ON/OFF. EN_ All rails and belts are DALI and ON/OFF compatible. FR_ Tous les rails et courroies sont compatibles DALI et ON/OFF. IT_ Tutti i binari e le cinghie sono compatibili con DALI e ON/OFF.

ES_ Longitud máxima: 7 m. Potencia máxima: 60W. EN_ Maximum length: 7 m. Maximum power: 60 W FR_ Longueur maximale : 7 m. Puissance maximale : 60 W. IT_ Lunghezza massima: 7 m. Potenza massima: 60 W.



Image: Belt models



Image: Accessories & belt models

ACCESORIOS CORREAS 48V



Adaptador punto fijo correa / Belt fixed adapter / Adaptateur fixe pour ceinture / Adattatore fisso per cintura

● 66345 10,95€

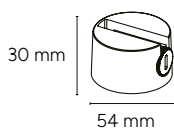

Conector alimentación de correa a carril / Track power connector / Connecteur d'alimentation pour rail / Connettore di alimentazione a binario

● 66347 34,95€

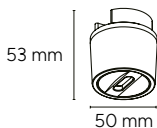

Cut out: 68 mm

Conector alimentación de correa a techo / Belt ceiling power connector / Connecteur d'alimentation pour le plafond de la ceinture / Connettore di alimentazione a soffitto del nastro

● 66349 34,95€

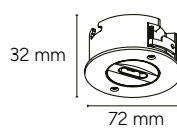

Hebilla punto fijo correa / Belt fixed buckle / Boucle fixe de la ceinture / Fibbia fissa della cinghia

● 66353 5,95€

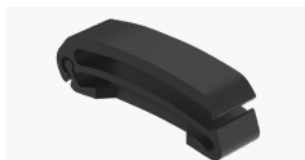
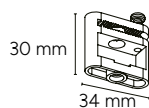

Hebilla punto final correa / Belt end locked buckle / Boucle verrouillée à l'extrémité de la ceinture / Fibbia bloccata all'estremità della cinghia

● 66355 2,95€

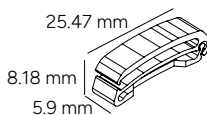

Unión conexión eléctrica correa / Belt power connector / Connecteur d'alimentation de la ceinture / Connettore di alimentazione del nastro

● 66357 23,95€

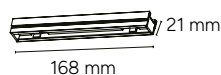

Fuentes de alimentación 48V / Power supplies 48V / Alimentation électrique 48V / Alimentazione 48V

Page 452



**FOCOS COMPATIBLES CON
EL CARRIL Y LA CORREA
DE 48V**



PROYECTOR MINI MARKO



CODE	W	Lm	K	BEAM°	COLOR	DIMMABLE	PRICE
65986	2W	151Lm	2700K	15	N ●	ON/OFF	59,95€
65987	2W	157Lm	3000K	24	N ●	ON/OFF	59,95€
65989	2W	151Lm	2700K	38	N ●	DALI/PUSH	119,95€
65990	2W	157Lm	3000K		N ●	DALI/PUSH	119,95€

CREE LED CHIP **IP** 20 UGR + 19 **Alu** EM **CE** **Cri > 90**

2W

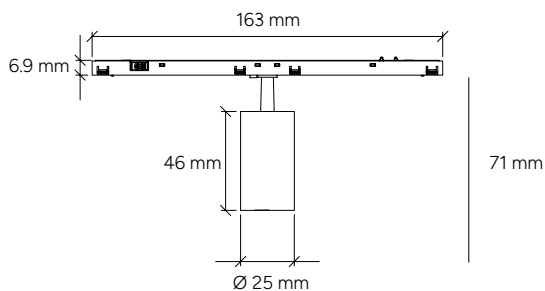

MARKO PROYECTOR



CODE	W	Lm	K	BEAM°	COLOR	DIMMABLE	PRICE
66036	7W	385Lm	2700K	15	N ●	ON/OFF	69,95€
66037	7W	400Lm	3000K	24	N ●	ON/OFF	69,95€
				38			

CODE	W	Lm	K	BEAM°	COLOR	DIMMABLE	PRICE
66056	15W	825Lm	2700K	15	N ●	ON/OFF	89,95€
66057	15W	890Lm	3000K	24	N ●	ON/OFF	89,95€
66059	15W	825Lm	2700K	38	N ●	DALI/PUSH	159,95€
66060	15W	890Lm	3000K		N ●	DALI/PUSH	159,95€

CREE LED CHIP **IP 20** UGR = 19 48V 50/60Hz **Alu** EM **CE** -20 / +40 **Cri > 90**

7W

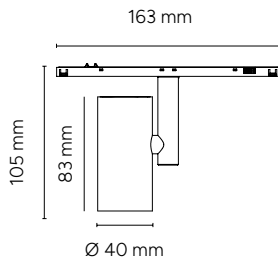

15W

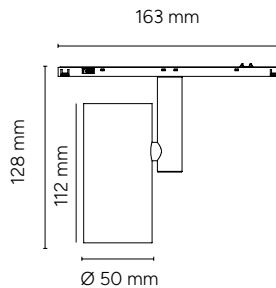

MARKO PROYECTOR ZOOM

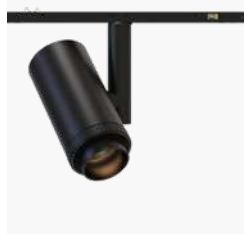

CODE	W	Lm	K	BEAM°	COLOR	DIMMABLE	PRICE
66006	7W	385Lm	2700K	15-45	N ●	ON/OFF	89,95€
66007	7W	400Lm	3000K	15-45	N ●	ON/OFF	89,95€
66018	15W	825Lm	2700K	15-45	N ●	ON/OFF	109,95€
66019	15W	890Lm	3000K	15-45	N ●	ON/OFF	109,95€
66021	15W	825Lm	2700K	15-45	N ●	DALI/PUSH	169,95€
66022	15W	890Lm	3000K	15-45	N ●	DALI/PUSH	169,95€

CREE LED CHIP **IP 20** UGR < 19 **48V** 50/60Hz **Alu** EM **3** Smart Control **Cri>90** -20 / +40

7W

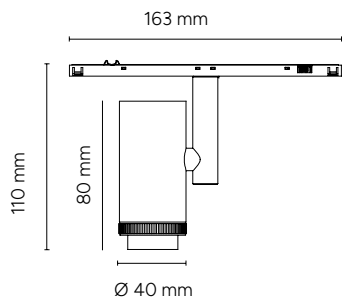

15W

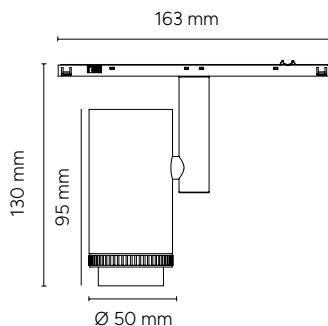



45° ————— 15°

ACCENT LIGHTING

MARKO SEMIESFERA



CODE	W	Lm	K	BEAM°	COLOR	DIMMABLE	PRICE
66076	8W	724Lm	2700K	15	N ●	ON/OFF	79,95€
66077	8W	745Lm	3000K	24	N ●	ON/OFF	79,95€
66079	8W	724Lm	2700K	38	N ●	DALI/PUSH	149,95€
66080	8W	745Lm	3000K		N ●	DALI/PUSH	149,95€

CREE LED CHIP **IP** 20 UGR < 19 48V 50/60Hz **Alu** EM **CE** **3** -20 / +40 **Cri>90**

8W

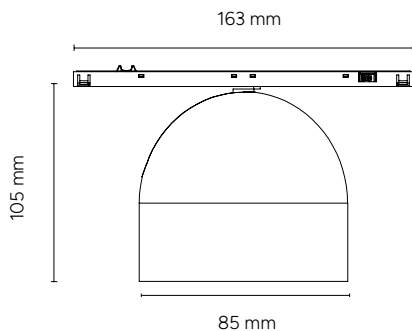

MARKO LINEAL FLEXIBLE



ES_ Accesorio de suspensión incluido
 EN_ Suspension accessory included
 FR_ Accessoires de suspension inclus
 IT_ Accessorio di sospensione incluso

CODE	W	Lm	K	BEAM°	COLOR	DIMMABLE	PRICE
66225	12W	405Lm	2700K	100	N ●	ON/OFF	59,95€
66226	12W	428Lm	3000K	100	N ●	ON/OFF	59,95€

CREE LED CHIP
 IP 20
 UGR < 19
 ⚡
 ⚠
 48V 50/60Hz
 Alu
 EM
 ⏏
 ⏏
 CE
 3
 Smart Control
 -20 / +40
 Cri > 90

12W

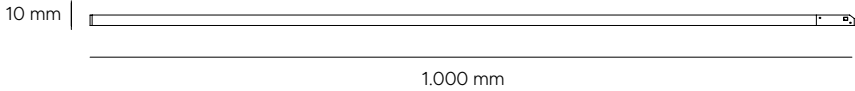

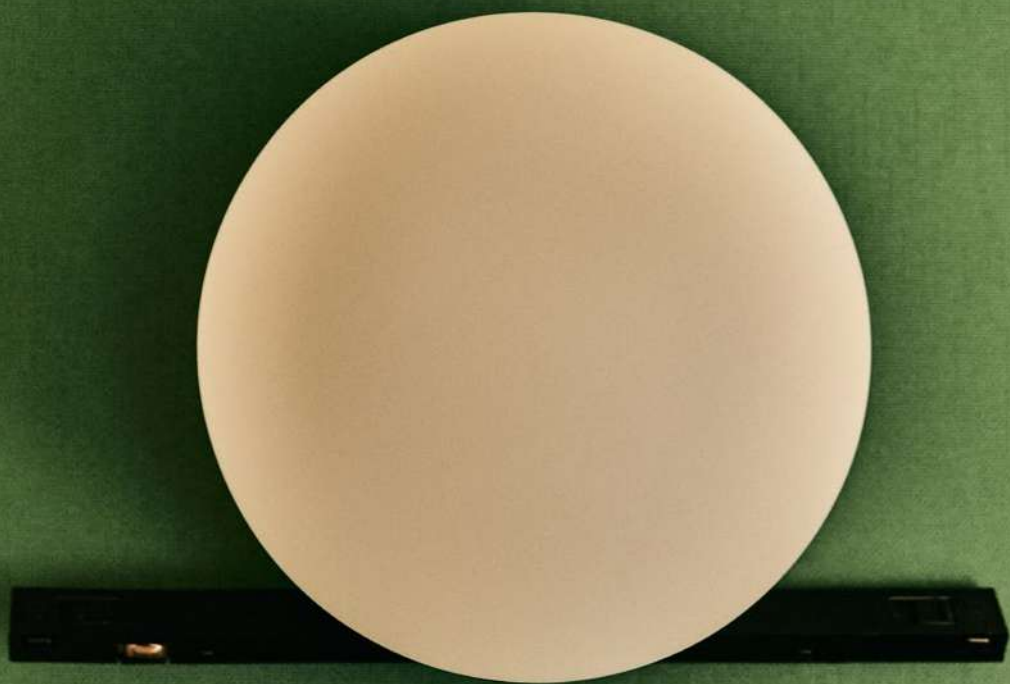
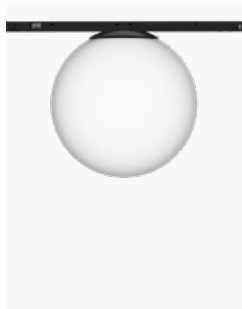

Image: Esfera MARKO

MARKO ESFERA



○ Fija / Fixed / Fixe / Fisso

○ Colgante / Pendant /
Suspension / Sospensione

CODE	W	Lm	K	BEAM°	VERSION	COLOR	DIMMABLE	PRICE
66096	8W	504Lm	2700K	355	○	N ●	ON/OFF	69,95€
66097	8W	535Lm	3000K	355	○	N ●	ON/OFF	69,95€
66099	8W	504Lm	2700K	355	○	N ●	DALI/PUSH	129,95€
66100	8W	535Lm	3000K	355	○	N ●	DALI/PUSH	129,95€

CODE	W	Lm	K	BEAM°	VERSION	COLOR	DIMMABLE	PRICE
66122	8W	504Lm	2700K	355	○	N ●	ON/OFF	69,95€
66123	8W	535Lm	3000K	355	○	N ●	ON/OFF	69,95€
66125	8W	504Lm	2700K	355	○	N ●	DALI/PUSH	129,95€
66126	8W	535Lm	3000K	355	○	N ●	DALI/PUSH	129,95€

CREE LED CHIP **IP 20** UGR < 19 **Alu** **Glass** EM -20 / +40 **Cri > 90**

8W

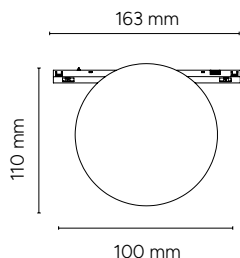

8W

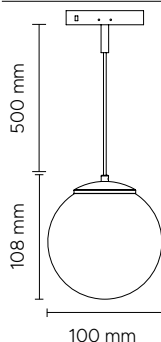

MARKO LINEAL



CODE	W	Lm	K	BEAM°	COLOR	DIMMABLE	PRICE
66156	20W	1905Lm	2700K	100	N ●	ON/OFF	89,95€
66157	20W	1935Lm	3000K	100	N ●	ON/OFF	89,95€
66159	20W	1905Lm	2700K	100	N ●	DALI/PUSH	189,95€
66160	20W	1935Lm	3000K	100	N ●	DALI/PUSH	189,95€

CREE LED CHIP **IP** 20 UGR < 19 48V 50/60Hz **Alu** EM **CE** -20 / +40 **Cri>90**

20W

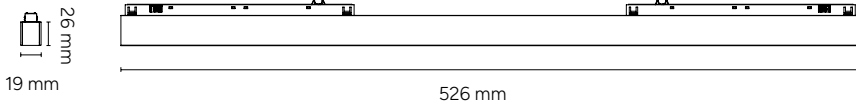

MARKO LINEAL GRILLE



CODE	W	Lm	K	BEAM°	COLOR	DIMMABLE	PRICE
66186	20W	1725Lm	2700K	15	N ●	ON/OFF	139,95€
66187	20W	1800Lm	3000K	24	N ●	ON/OFF	139,95€
66189	20W	1725Lm	2700K	36	N ●	DALI/PUSH	199,95€
66190	20W	1800Lm	3000K		N ●	DALI/PUSH	199,95€

CREE LED CHIP **IP** 20 UGR < 19 48V 50/60Hz **Alu** EM **CE** -20 / +40 **Cri>90**

20W

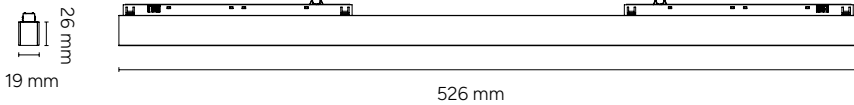

MARKO LINEAL GRILLE ABATIBILE



CODE	W	Lm	K	BEAM°	COLOR	DIMMABLE	PRICE
66236	10W	908Lm	2700K	15	N ●	ON/OFF	89,95€
66237	10W	945Lm	3000K	24	N ●	ON/OFF	89,95€
66239	10W	908Lm	2700K	36	N ●	DALI/PUSH	149,95€
66240	10W	945Lm	3000K		N ●	DALI/PUSH	149,95€

CREE LED CHIP
 IP 20
 UGR < 19
 48V 50/60Hz
 Alu
 EM
 CE
 3
 Smart Control
 Cri > 90

10W

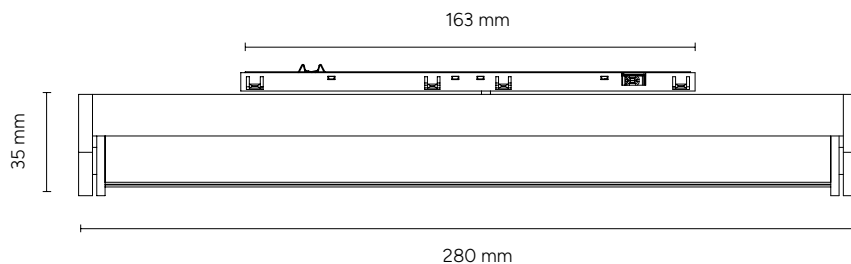



LINEAL 48V
BASCULANTE

INCLINE
OUTLINE 48V
ADJUSTABLE

PLAN
INCLINÉ 48V
RÉGLABLE

INCLINAZIONE 48V
REGOLABILE

interi or empotr trar



ILUMINACIÓN DE
INTERIOR
EMPOTRADA

RECESSED
INDOOR
LIGHTING

ÉCLAIRAGE
INTÉRIEUR
ENCASTRÉ

ILLUMINAZIONE
INTERNA A
INCASSO

Image: FENIX models

ES_ Ilumina sin ocupar espacio. EN_ Illuminates without taking up space.
FR_ Illumine sans prendre de place. IT_ Illumina senza occupare spazio.



FENIX

Caja de empotrar incluida. / Recessed box included. / Boîte d'encastrement incluse. / Scatola da incasso inclusa.

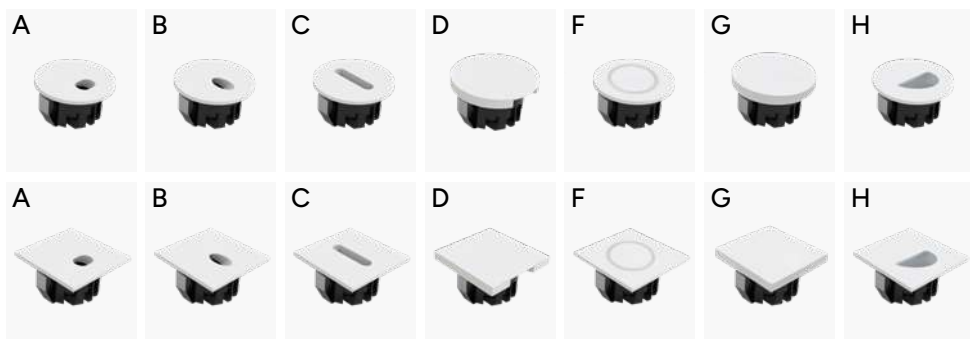

CODE	W	Lm	K	TYPE	VERSION	COLOR	DIMMABLE	PRICE
62900	3W	240Lm	2700K	A	R	B	ON/OFF	24,95€
62901	3W	250Lm	3000K	B	C	N	ON/OFF	24,95€
62902	3W	260Lm	4000K	C			ON/OFF	24,95€
				D				
				F				
				G				
				H				



CODE	W	Lm	K	TYPE	VERSION	COLOR	DIMMABLE	PRICE
62900	3W	240Lm	2700K	E	R	O	ON/OFF	24,95€
62901	3W	250Lm	3000K		C		ON/OFF	24,95€
62902	3W	260Lm	4000K				ON/OFF	24,95€

IP 20



200-240V
50/60Hz

Alu PC

EM



Cri > 80

*O: Opal / Opale / Opale

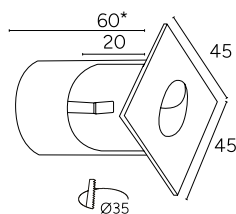
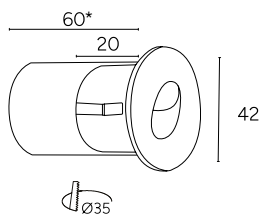

*Caja de empotrar / Recessed box / Boîte d'encastrement / Scatola da incasso

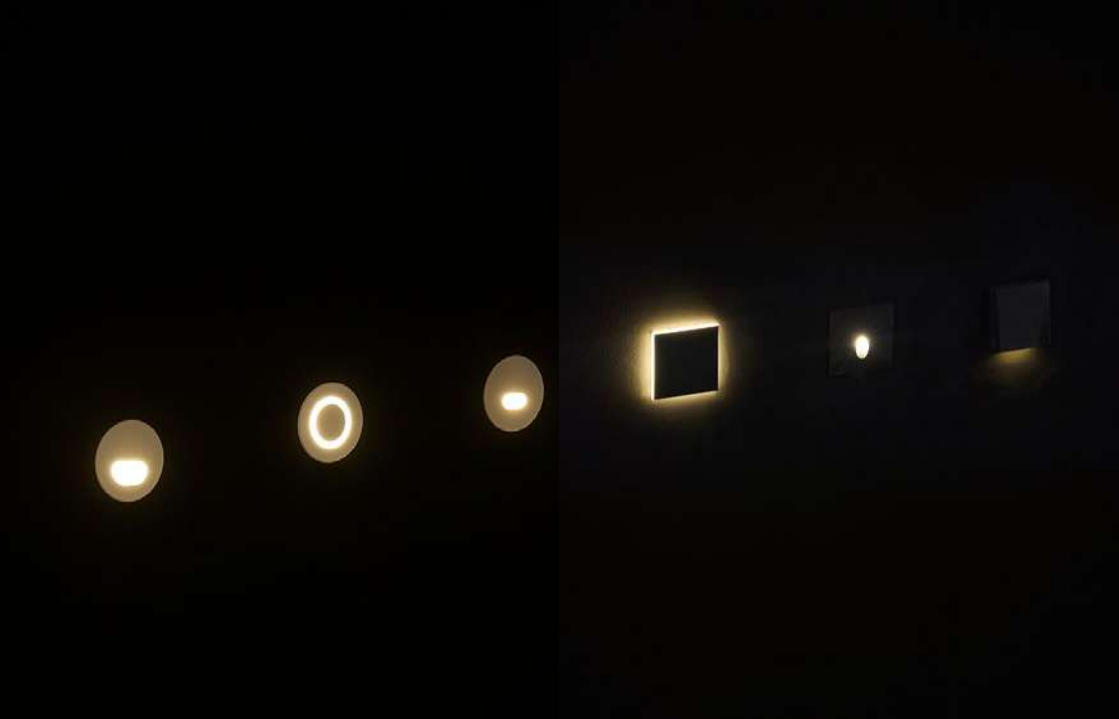

apliques de interior



APLIQUES DE INTERIOR

ES_ Diseños acogedores para una iluminación suave y envolvente que realza salones, pasillos y dormitorios. Descubre el modelo que mejor se adapta a tu proyecto.

INDOOR APPLIANCES

EN_ Cozy designs for soft and enveloping lighting that enhances living rooms, corridors and bedrooms. Discover the model that best suits your project.

APPAREILS D'INTÉRIEUR

FR_ Des designs chaleureux pour un éclairage doux et enveloppant qui met en valeur les salons, les couloirs et les chambres à coucher. Découvrez le modèle qui convient le mieux à votre projet.

INFISSI INTERNI

IT_ Design accoglienti e morbida e avvolgente che valorizza soggiorni, corridoi e camere da letto. Scoprite il modello più adatto al vostro progetto.



ADHAR

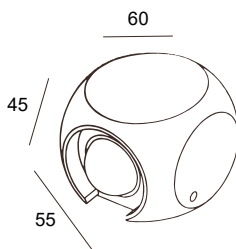

CODE	W	Lm	K	BEAM°	COLOR	PRICE
60869	2x1W	190Lm	3000K	60	B ○	29,95€
60870	2x1W	200Lm	4000K	60	B ○	29,95€



NARA

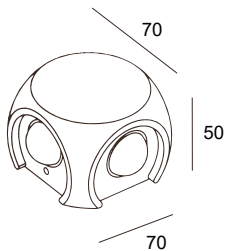

CODE	W	Lm	K	BEAM°	COLOR	PRICE
60872	4x1W	380Lm	3000K	60	B ○	34,95€
60873	4x1W	400Lm	4000K	60	B ○	34,95€





Image: NARA model effect

IRENE



CODE	W	Lm	K	BEAM°	COLOR	PRICE
61129	2x3W	230Lm	3000K	30	A ●	69,95€
61130	2x3W	250Lm	4000K	30	A ●	69,95€
61132	4x3W	600Lm	3000K	30	A ●	79,95€
61133	4x3W	640Lm	4000K	30	A ●	79,95€
61135	6x1W	500Lm	3000K	30	A ●	99,95€
61136	6x1W	530Lm	4000K	30	A ●	99,95€

CREE LED CHIP

EAGLE RISE LED DRIVER

IP 54



220-240V
50/60Hz

Alu

PMMA
Diffuser Cover



CE

3



-20 / +45

Cri > 80

2x3W

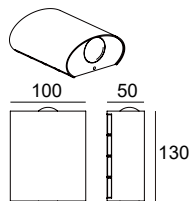

4x3W

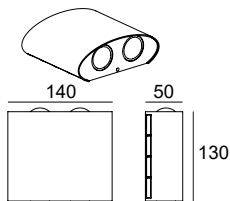

6x1W

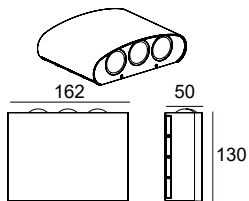

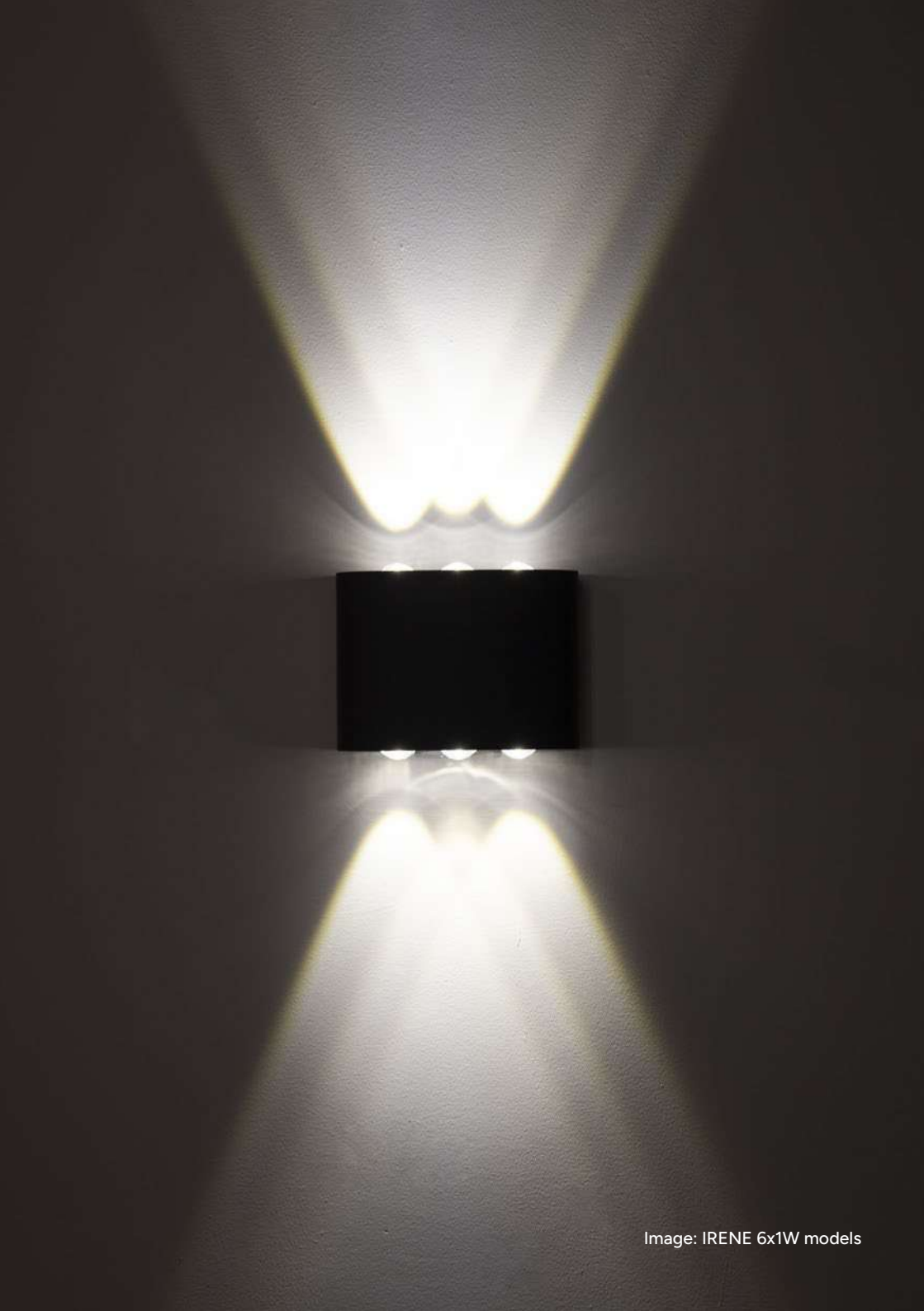

Image: IRENE 6x1W models

luminaria lineal



LUMINARIA LINEAL

ES_ Con su sofisticada presencia, ofrecen una iluminación discreta y elegante, ideal para espacios que buscan una atmósfera minimalista sin sacrificar funcionalidad.

LINEAR LUMINAIRE

EN_ With their sophisticated presence, they offer discreet and elegant lighting, ideal for spaces that seek a minimalist atmosphere without sacrificing functionality.

LUMINAIRE LINÉAIRE

FR_ Avec leur présence sophistiquée, ils offrent un éclairage discret et élégant, idéal pour les espaces qui recherchent une atmosphère minimaliste sans sacrifier la fonctionnalité.

APPARECCHIO LINEARE

IT_ Con la loro presenza sofisticata, offrono un'illuminazione discreta ed elegante, ideale per gli spazi che cercano un'atmosfera minimalista senza rinunciare alla funzionalità.

Image: 45W ZEBRA model
Project: VGP Offices Barcelona, Spain



ZEBRA

SUPERFICIE-SUSPENSIÓN / SURFACE-SUSPENDED / SUPERFICIE / SOSPESO



2700 - 3000 - 4000K

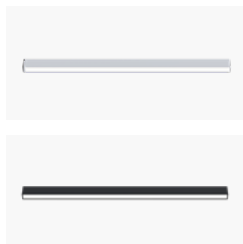
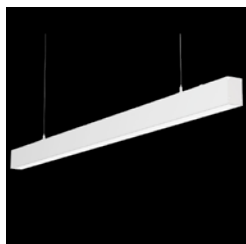

CODE	W	Lm	K	BEAM°	COLOR	DIMMABLE	PRICE
63170	45W	4950Lm	3 CCT	120	B ○	ON/OFF	129,95€
63171	45W	4950Lm	3 CCT	120	N ●	ON/OFF	129,95€
63172	55W	6250Lm	3 CCT	120	B ○	ON/OFF	169,95€
63173	55W	6250Lm	3 CCT	120	N ●	ON/OFF	169,95€
63174	65W	7750Lm	3 CCT	120	B ○	ON/OFF	199,95€
63175	65W	7750Lm	3 CCT	120	N ●	ON/OFF	199,95€

CODE	W	Lm	K	BEAM°	COLOR	DIMMABLE	PRICE
63170C	45W	4950Lm	3 CCT	120	B ○	DALI/PUSH	169,95€
63171C	45W	4950Lm	3 CCT	120	N ●	DALI/PUSH	169,95€
63172C	55W	6250Lm	3 CCT	120	B ○	DALI/PUSH	199,95€
63173C	55W	6250Lm	3 CCT	120	N ●	DALI/PUSH	199,95€
63174C	65W	7750Lm	3 CCT	120	B ○	DALI/PUSH	249,95€
63175C	65W	7750Lm	3 CCT	120	N ●	DALI/PUSH	249,95€



Kit de suspensión de 1,5 metros incluido. Suspension kit 1.5 meters included.
Kit de suspension de 1,5 mètre inclus. Kit di sospensione da 1,5 metri incluso.

Cable eléctrico de 1.6 metros incluido. Electrical cable 1.6 meters included.
Câble d'alimentation de 1,6 mètre inclus. Cavo di alimentazione da 1,6 metri incluso.

ZEBRA

SUPERFICIE-SUSPENSIÓN / SURFACE-SUSPENDED / SUPERFICIE / SOSPEO

Conector / Connector / Connecteur / Connettore



CODE 1	COLOR	PRICE
85027	● Aluminio / Aluminium / Alluminio	2,95€

45W

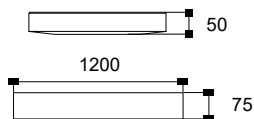

55W

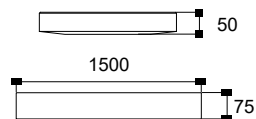

65W

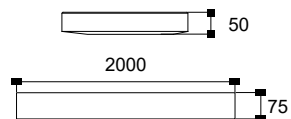



12W

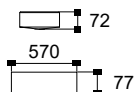

24W

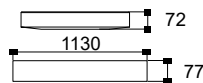

30W

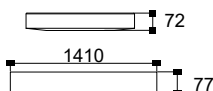

36W

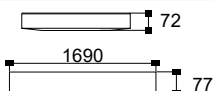

□ Empotrar / Embed / Intégrer / Incasso

CODE	W	Lm	K	BEAM°	COLOR	DIMMABLE	PRICE
10383101UGR77	12W	1680Lm	3000K	120	B ○	ON/OFF	259,99€
10383201UGR77	12W	1680Lm	3000K	120	G ●	ON/OFF	269,99€
10383301UGR77	12W	1680Lm	3000K	120	N ●	ON/OFF	279,99€
10383181UGR77	12W	1680Lm	3000K	120	B ○	DALI/PUSH	299,99€
10383281UGR77	12W	1680Lm	3000K	120	G ●	DALI/PUSH	309,99€
10383381UGR77	12W	1680Lm	3000K	120	N ●	DALI/PUSH	319,99€
10383102UGR77	24W	4080Lm	3000K	120	B ○	ON/OFF	309,99€
10383202UGR77	24W	4080Lm	3000K	120	G ●	ON/OFF	319,99€
10383302UGR77	24W	4080Lm	3000K	120	N ●	ON/OFF	329,99€
10383182UGR77	24W	4080Lm	3000K	120	B ○	DALI/PUSH	379,99€
10383282UGR77	24W	4080Lm	3000K	120	G ●	DALI/PUSH	389,99€
10383382UGR77	24W	4080Lm	3000K	120	N ●	DALI/PUSH	399,99€
10383104UGR77	30W	5100Lm	3000K	120	B ○	ON/OFF	359,99€
10383204UGR77	30W	5100Lm	3000K	120	G ●	ON/OFF	369,99€
10383304UGR77	30W	5100Lm	3000K	120	N ●	ON/OFF	379,99€
10383184UGR77	30W	5100Lm	3000K	120	B ○	DALI/PUSH	429,99€
10383284UGR77	30W	5100Lm	3000K	120	G ●	DALI/PUSH	439,99€
10383384UGR77	30W	5100Lm	3000K	120	N ●	DALI/PUSH	449,99€
10383103UGR77	36W	6120Lm	3000K	120	B ○	ON/OFF	379,99€
10383203UGR77	36W	6120Lm	3000K	120	G ●	ON/OFF	389,99€
10383303UGR77	36W	6120Lm	3000K	120	N ●	ON/OFF	399,99€
10383183UGR77	36W	6120Lm	3000K	120	B ○	DALI/PUSH	449,99€
10383283UGR77	36W	6120Lm	3000K	120	G ●	DALI/PUSH	459,99€
10383383UGR77	36W	6120Lm	3000K	120	N ●	DALI/PUSH	469,99€

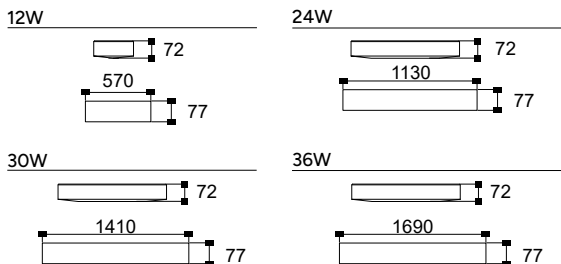

□ Empotrar / Embed / Intégrer / Incasso

CODE	W	Lm	K	BEAM°	COLOR	DIMMABLE	PRICE
103841010UGR77	12W	1680Lm	4000K	120	B ○	ON/OFF	259,99€
103842010UGR77	12W	1680Lm	4000K	120	G ●	ON/OFF	269,99€
103843010UGR77	12W	1680Lm	4000K	120	N ●	ON/OFF	279,99€
103841810UGR77	12W	1680Lm	4000K	120	B ○	DALI/PUSH	299,99€
103842810UGR77	12W	1680Lm	4000K	120	G ●	DALI/PUSH	309,99€
103843810UGR77	12W	1680Lm	4000K	120	N ●	DALI/PUSH	319,99€
103841020UGR77	24W	4080Lm	4000K	120	B ○	ON/OFF	309,99€
103842020UGR77	24W	4080Lm	4000K	120	G ●	ON/OFF	319,99€
103843020UGR77	24W	4080Lm	4000K	120	N ●	ON/OFF	329,99€
103841820UGR77	24W	4080Lm	4000K	120	B ○	DALI/PUSH	379,99€
103842820UGR77	24W	4080Lm	4000K	120	G ●	DALI/PUSH	389,99€
103843820UGR77	24W	4080Lm	4000K	120	N ●	DALI/PUSH	399,99€
103841041UGR77	30W	5100Lm	4000K	120	B ○	ON/OFF	359,99€
103842041UGR77	30W	5100Lm	4000K	120	G ●	ON/OFF	369,99€
103843041UGR77	30W	5100Lm	4000K	120	N ●	ON/OFF	379,99€
103841841UGR77	30W	5100Lm	4000K	120	B ○	DALI/PUSH	429,99€
103842841UGR77	30W	5100Lm	4000K	120	G ●	DALI/PUSH	439,99€
103843841UGR77	30W	5100Lm	4000K	120	N ●	DALI/PUSH	449,99€
103841030UGR77	36W	6120Lm	4000K	120	B ○	ON/OFF	379,99€
103842030UGR77	36W	6120Lm	4000K	120	G ●	ON/OFF	389,99€
103843030UGR77	36W	6120Lm	4000K	120	N ●	ON/OFF	399,99€
103841830UGR77	36W	6120Lm	4000K	120	B ○	DALI/PUSH	449,99€
103842830UGR77	36W	6120Lm	4000K	120	G ●	DALI/PUSH	459,99€
103843830UGR77	36W	6120Lm	4000K	120	N ●	DALI/PUSH	469,99€



☐ Superficie / Surface / Superficie

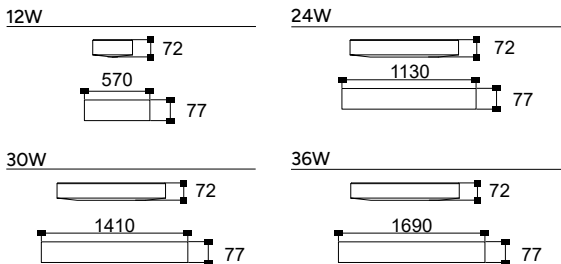

CODE	W	Lm	K	BEAM°	COLOR	DIMMABLE	PRICE
10383101UGR85	12W	1680Lm	3000K	120	B ○	ON/OFF	239,99€
103832010UGR85	12W	1680Lm	3000K	120	G ●	ON/OFF	249,99€
103833010UGR85	12W	1680Lm	3000K	120	N ●	ON/OFF	259,99€
103831810UGR85	12W	1680Lm	3000K	120	B ○	DALI/PUSH	279,99€
103832810UGR85	12W	1680Lm	3000K	120	G ●	DALI/PUSH	289,99€
103833810UGR85	12W	1680Lm	3000K	120	N ●	DALI/PUSH	299,99€
103831020UGR85	24W	4080Lm	3000K	120	B ○	ON/OFF	289,99€
103832020UGR85	24W	4080Lm	3000K	120	G ●	ON/OFF	299,99€
103833020UGR85	24W	4080Lm	3000K	120	N ●	ON/OFF	309,99€
103831820UGR85	24W	4080Lm	3000K	120	B ○	DALI/PUSH	359,99€
103832820UGR85	24W	4080Lm	3000K	120	G ●	DALI/PUSH	369,99€
103833820UGR85	24W	4080Lm	3000K	120	N ●	DALI/PUSH	379,99€
103831041UGR85	30W	5100Lm	3000K	120	B ○	ON/OFF	339,99€
103832041UGR85	30W	5100Lm	3000K	120	G ●	ON/OFF	349,99€
103833041UGR85	30W	5100Lm	3000K	120	N ●	ON/OFF	359,99€
103831841UGR85	30W	5100Lm	3000K	120	B ○	DALI/PUSH	409,99€
103832841UGR85	30W	5100Lm	3000K	120	G ●	DALI/PUSH	419,99€
103833841UGR85	30W	5100Lm	3000K	120	N ●	DALI/PUSH	429,99€
103831030UGR85	36W	6120Lm	3000K	120	B ○	ON/OFF	359,99€
103832030UGR85	36W	6120Lm	3000K	120	G ●	ON/OFF	369,99€
103833030UGR85	36W	6120Lm	3000K	120	N ●	ON/OFF	379,99€
103831830UGR85	36W	6120Lm	3000K	120	B ○	DALI/PUSH	429,99€
103832830UGR85	36W	6120Lm	3000K	120	G ●	DALI/PUSH	439,99€
103833830UGR85	36W	6120Lm	3000K	120	N ●	DALI/PUSH	449,99€



☐ Superficie / Surface / Superficie

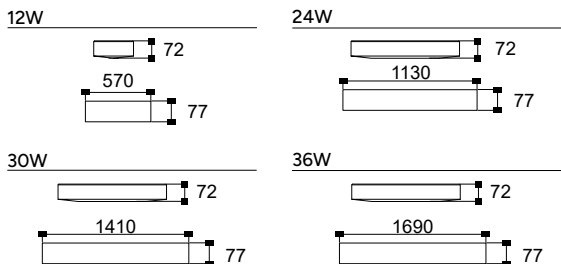

CODE	W	Lm	K	BEAM°	COLOR	DIMMABLE	PRICE
103841010UGR85	12W	1680Lm	4000K	120	B ○	ON/OFF	239,99€
103842010UGR85	12W	1680Lm	4000K	120	G ●	ON/OFF	249,99€
103843010UGR85	12W	1680Lm	4000K	120	N ●	ON/OFF	259,99€
103841810UGR85	12W	1680Lm	4000K	120	B ○	DALI/PUSH	279,99€
103842810UGR85	12W	1680Lm	4000K	120	G ●	DALI/PUSH	289,99€
103843810UGR85	12W	1680Lm	4000K	120	N ●	DALI/PUSH	299,99€
103841020UGR85	24W	4080Lm	4000K	120	B ○	ON/OFF	289,99€
103842020UGR85	24W	4080Lm	4000K	120	G ●	ON/OFF	299,99€
103843020UGR85	24W	4080Lm	4000K	120	N ●	ON/OFF	309,99€
103841820UGR85	24W	4080Lm	4000K	120	B ○	DALI/PUSH	359,99€
103842820UGR85	24W	4080Lm	4000K	120	G ●	DALI/PUSH	369,99€
103843820UGR85	24W	4080Lm	4000K	120	N ●	DALI/PUSH	379,99€
103841041UGR85	30W	5100Lm	4000K	120	B ○	ON/OFF	339,99€
103842041UGR85	30W	5100Lm	4000K	120	G ●	ON/OFF	349,99€
103843041UGR85	30W	5100Lm	4000K	120	N ●	ON/OFF	359,99€
103841841UGR85	30W	5100Lm	4000K	120	B ○	DALI/PUSH	409,99€
103842841UGR85	30W	5100Lm	4000K	120	G ●	DALI/PUSH	419,99€
103843841UGR85	30W	5100Lm	4000K	120	N ●	DALI/PUSH	429,99€
103841030UGR85	36W	6120Lm	4000K	120	B ○	ON/OFF	359,99€
103842030UGR85	36W	6120Lm	4000K	120	G ●	ON/OFF	369,99€
103843030UGR85	36W	6120Lm	4000K	120	N ●	ON/OFF	379,99€
103841830UGR85	36W	6120Lm	4000K	120	B ○	DALI/PUSH	429,99€
103842830UGR85	36W	6120Lm	4000K	120	G ●	DALI/PUSH	439,99€
103843830UGR85	36W	6120Lm	4000K	120	N ●	DALI/PUSH	449,99€

SIMA ACCESORIES



□ Empotrar / Embed / Intégrer / Incasso

CODE	DESCRIPTION	PRICE
1038CODO9058	Ángulo 90° Sima empotrar / Angle 90° Sima recessed / Angle 90° Sima encastrement / Angolo 90° Montaggio ad incasso Sima	89,95€
1038315MM58	ON/ OFF: Precableado 3x1.5 mm2 Sima empotrar / Pre-wiring 3x1.5 mm2 Sima flush-mounted / Pré-câblage 3x1,5 mm2 Sima encastré / Pre-cablaggio 3x1,5 mm2 Sima da incasso	42,95€
1038515MM58	DALI: Precableado 5x1.5 mm2 Sima empotrar / Pre-wiring 5x1.5 mm2 Sima flush-mounted / Pré-câblage 5x1,5 mm2 Sima encastré / Pre-cablaggio 5x1,5 mm2 Sima da incasso	79,95€
1038KE1H	Kit emergencia 1 hora / Emergency kit 1 hour / Kit d'urgence 1 heure / Kit di emergenza 1 ora	239,95€
1038TRIM	Sistema Trimless Sima / Sima Trimless System / Système Sima Trimless	53,95€

SIMA ACCESORIES



 Superficie / Surface / Superficie

CODE	DESCRIPTION	PRICE
1038KS1M58	Kit suspensión Sima 1 m / Sima suspension kit 1 m / Kit de suspension Sima 1 m / Kit di sospensione Sima 1 m	48,95€
1038CODO9077	Ángulo 90° Sima superficie / Angle 90° Sima surface / Angle 90° Sima surface / Angolo 90° Superficie Sima	89,95€
1038315MM77	ON/ OFF: Precableado 3x1.5 mm2 Sima empotrar / Pre-wiring 3x1.5 mm2 Sima flush-mounted / Pré-câblage 3x1,5 mm2 Sima encastré / Pre-cablaggio 3x1,5 mm2 Sima da incasso	42,95€
1038515MM77	DALI: Precableado 5x1.5 mm2 Sima empotrar / Pre-wiring 5x1.5 mm2 Sima flush-mounted / Pré-câblage 5x1,5 mm2 Sima encastré / Pre-cablaggio 5x1,5 mm2 Sima da incasso	79,95€
1038KE1H	Kit emergencia 1 hora / Emergency kit 1 hour / Kit d'urgence 1 heure / Kit di emergenza 1 ora	239,95€
1038KBM	Kit brazo mural / Wall arm kit / Kit de bras mural / Kit braccio a parete	64,95€

paneles LED

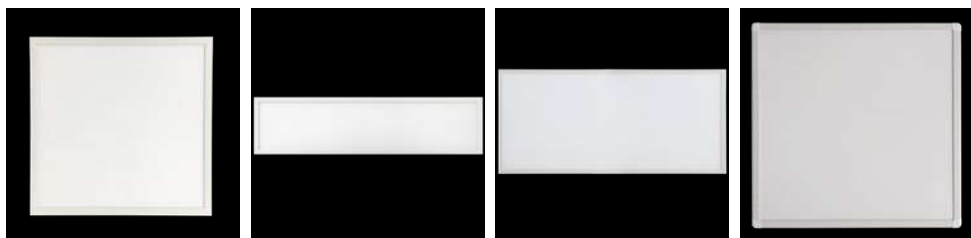

PANELES
LED

LED
PANELS

DALLES
LED

PANELLI
LED



Image: VENUS BACKLIT models

VENUS

BACKLIT



3000 - 4000 - 6000K



□ Cuadrado / Square / Carrè / Quadrato

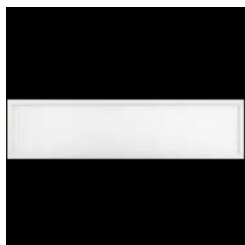

◻ Rectangular
Rectangulaire
Rettangolare



◻ Rectangular
Rectangulaire
Rettangolare

CODE	W	Lm	K	BEAM°	COLOR	VERSION	DIMMABLE	PRICE
60650	36W	3600Lm	3 CCT	120	B ○	□	ON/OFF	49,95€
60651	36W	3600Lm	3 CCT	120	B ○	◻	ON/OFF	59,95€
60652	60W	6000Lm	3 CCT	120	B ○	◻	ON/OFF	129,95€
60650A	36W	3600Lm	3 CCT	120	B ○	□	TRIAC	69,95€
60651A	36W	3600Lm	3 CCT	120	B ○	◻	TRIAC	79,95€
60652A	60W	6000Lm	3 CCT	120	B ○	◻	TRIAC	149,95€
60650B	36W	3600Lm	3 CCT	120	B ○	□	1-10V	72,95€
60651B	36W	3600Lm	3 CCT	120	B ○	◻	1-10V	82,95€
60652B	60W	6000Lm	3 CCT	120	B ○	◻	1-10V	152,95€
60650C	36W	3600Lm	3 CCT	120	B ○	□	DALI/PUSH	92,95€
60651C	36W	3600Lm	3 CCT	120	B ○	◻	DALI/PUSH	102,95€
60652C	60W	6000Lm	3 CCT	120	B ○	◻	DALI/PUSH	182,95€

EPISTAR
LED CHIP

FAA FREE
LED DRIVER

IP
20

UGR < 19



220-240V
50/60Hz

AL

PC

EM



CE

3
YEAR
WARRANTY



-20 / +40

Cri > 80

SQUARE

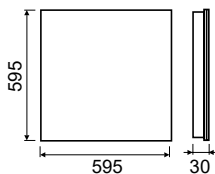

RECTANGULAR



RECTANGULAR



GALAXY

SURFACE



3000 - 4000 - 5000 - 6000K

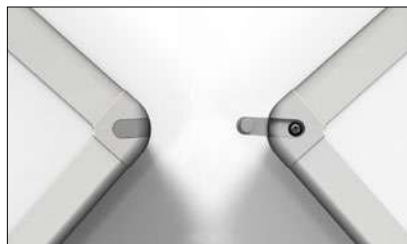

□ Cuadrado / Square /
Carré / Quadrato

◻ Rectangular
Rectangulaire
Rettangolare

CODE	W	Lm	K	BEAM°	COLOR	VERSION	DIMMABLE	PRICE
60670	36W	3600Lm	4 CCT	90	B ○	◻	ON/OFF	99,95€
60671	36W	3600Lm	4 CCT	90	B ○	◻	ON/OFF	129,95€
60670A	36W	3600Lm	4 CCT	90	B ○	◻	TRIAC	119,95€
60671A	36W	3600Lm	4 CCT	90	B ○	◻	TRIAC	149,95€
60670B	36W	3600Lm	4 CCT	90	B ○	◻	1-10V	129,95€
60671B	36W	3600Lm	4 CCT	90	B ○	◻	1-10V	159,95€
60670C	36W	3600Lm	4 CCT	90	B ○	◻	DALI/PUSH	129,95€
60671C	36W	3600Lm	4 CCT	90	B ○	◻	DALI/PUSH	159,95€

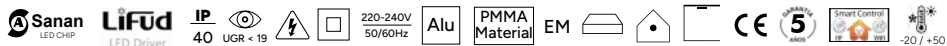

SQUARE

RECTANGULAR

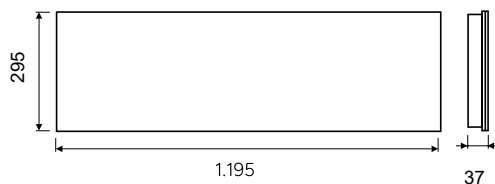
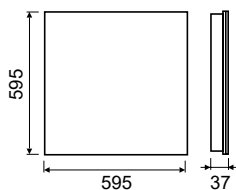

iluminación industrial



ILUMINACIÓN
INDUSTRIAL

INDUSTRIAL
LIGHTING

ÉCLAIRAGE
INDUSTRIEL

ILLUMINAZIONE
INDUSTRIALE

Image: DAPHNE models
Project: L'Eliana, Valencia





DAPHNE



3000 - 4000 - 6000K



POWER SELECTOR

100-150-200W

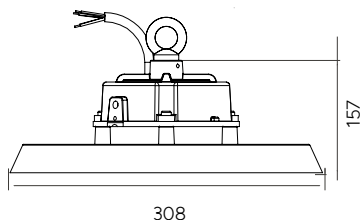

CODE	W	Lm	K	BEAM°	COLOR	DIMMABLE	PRICE
64088	100-150-200W	16000-24000-32000Lm	3 CCT	60	N ●	1-10V	169,95€
64089	100-150-200W	16000-24000-32000Lm	3 CCT	90	N ●	1-10V	169,95€
64090	100-150-200W	16000-24000-32000Lm	3 CCT	120	N ●	1-10V	169,95€

LUMILEDS LED CHIP
SOSEN LED CHIP
IP 65

IK 09
 220-240V 50/60Hz
Alu
PC
 EM

CE

100-150-200W



ES_ Utilice una herramienta para abrir la tapa.
EN_ Use a tool to open the cover. **FR_** Utiliser un outil pour ouvrir le couvercle. **IT_** Utilizzare uno strumento per aprire il coperchio.

A	B	C
200W	150W	100W
CW	NW	WW

ES_ Como indica la tabla, ajuste la potencia y la temperatura de color. **EN_** According to the table, adjust the power and color temperature. **FR_** Utiliser un outil pour ouvrir le couvercle. **IT_** In base alla tabella, regolare la potenza e la temperatura del colore.

luminarias estancas

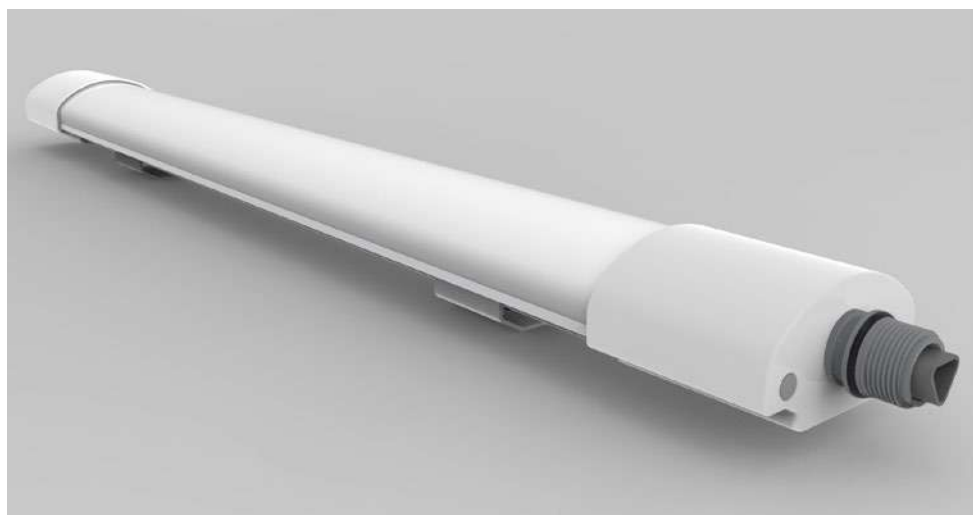

LUMINARIAS
ESTANCAS

WATERPROOF
LUMINAIRES

LUMINAIRES
ÉTANCHES

PLAFONIERA
STAGNA

→
GALLERIES
TERRACE SHOP
BAR





BELA



CODE	W	Lm	K	BEAM°	COLOR	DIMMABLE	PRICE
60981	14W	1820Lm	4000K	120	B ○	ON/OFF	49,95€
60984	30W	3900Lm	4000K	120	B ○	ON/OFF	59,95€
60987	43W	5590Lm	4000K	120	B ○	ON/OFF	79,95€



Suspension kit 1.5 m x2

CODE: 60989 11,75€

Connection cable 0.5 m
male/female

CODE: 60990 8,95€

Connection cable 1 m
male/female

CODE: 60991 11,75€

Connection cable 2 m
male/female

CODE: 60992 15,45€



14W

30W

43W

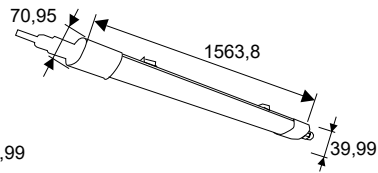
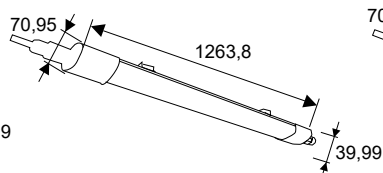
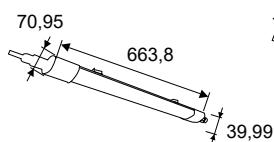

iluminación deportiva y grandes áreas

ILUMINACIÓN
DEPORTIVA Y
GRANDES ÁREAS

SPORTS LIGHTING
AND LARGE AREAS

L'ÉCLAIRAGE
SPORTIF ET LES
GRANDES SURFACES

ILLUMINAZIONE
SPORTIVA E
GRANDI AREE

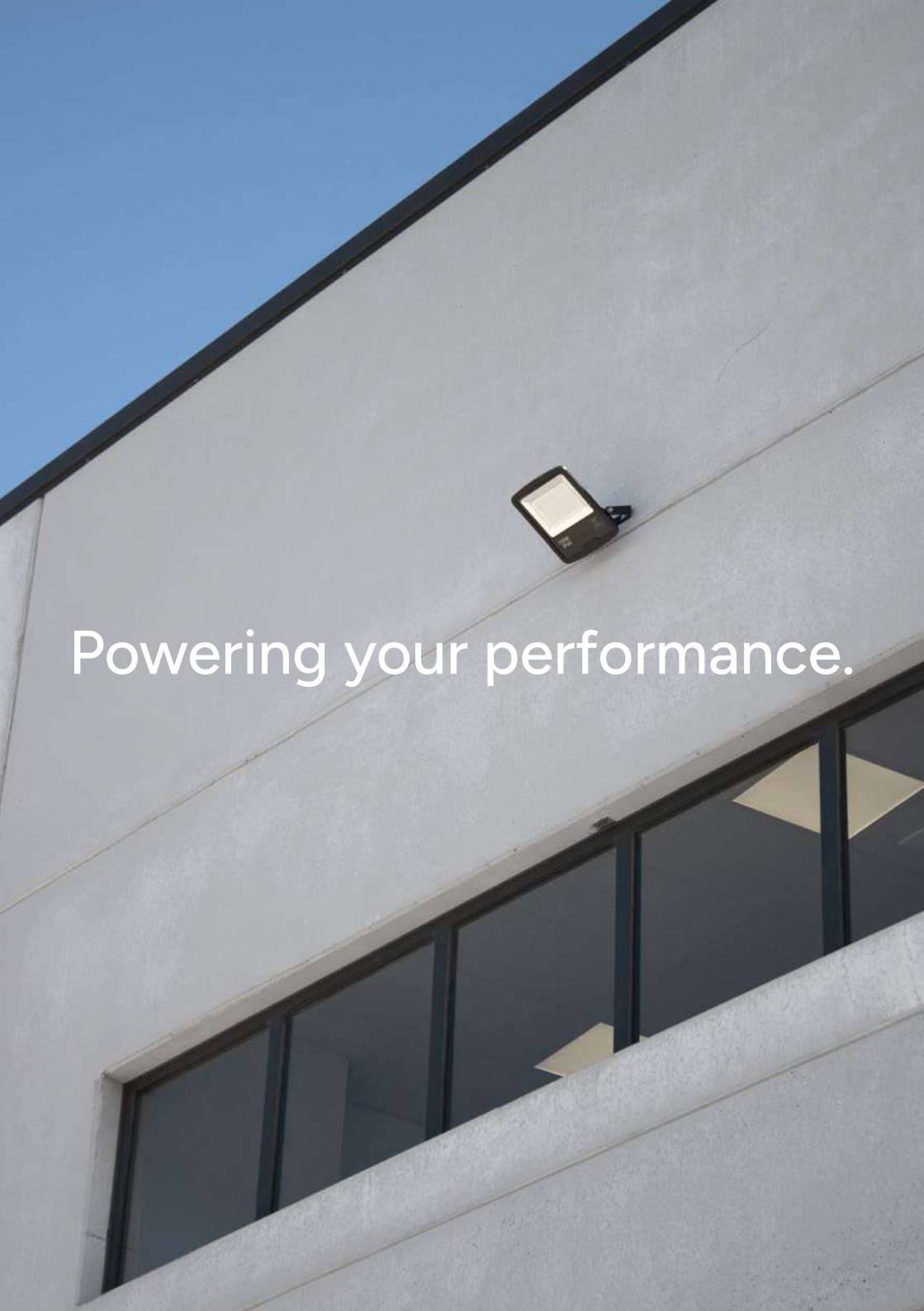

Powering your performance.

NOVA



3000 - 4000 - 6000K



POWER SELECTOR

100-150-200W

CODE	W	Lm	K	BEAM°	COLOR	DIMMABLE	PRICE
64203	100-150-200W	30000Lm	3 CCT	120	N ●	1-10V	199,95€

LUMILEDS
LED CHIP

IP
66



IK
07

120-277V
50/60Hz

Alu

PC

EM



CE

5
YEAR
WARRANTY



Cri>80

120-160-200W

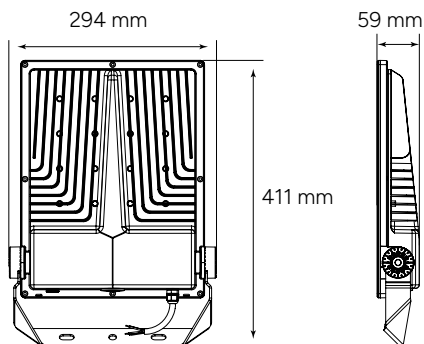

GOLDEN



Bracket Design

Bending brackets can be quickly installed using tools, saving installation time and costs.



Eye-bolt



Adjustable bracket

CODE	W	Lm	K	BEAM°	COLOR	DIMMABLE	PRICE
64049	200W	30000Lm	4000K	120	N ●	1-10V	299,95€
64070	200W	30000Lm	4000K	135x60	N ●	1-10V	299,95€
64052	300W	45000Lm	4000K	120	N ●	1-10V	479,95€
64073	300W	45000Lm	4000K	135x60	N ●	1-10V	479,95€
64055	400W	56000Lm	4000K	120	N ●	1-10V	599,95€
64076	400W	56000Lm	4000K	135x60	N ●	1-10V	599,95€
64058	500W	75000Lm	4000K	120	N ●	1-10V	799,95€
64079	500W	75000Lm	4000K	135x60	N ●	1-10V	799,95€



200W

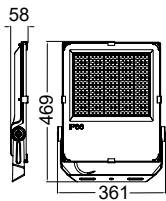

300-400W

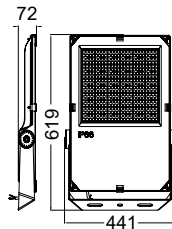

500W

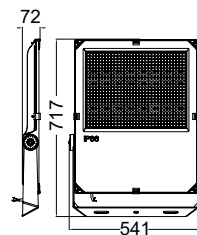

luminaria exterior de empotrar



ILUMINACIÓN EXTERIOR DE EMPOTRAR

ES_ Transforma tu jardín en un refugio nocturno único y acogedor con luminarias discretas de luz cálida o neutra.

OUTDOOR RECESSED LIGHTING

EN_ Transform your garden into a unique and cosy night shelter with discreet luminaires in warm or neutral light.

ÉCLAIRAGE ENCASTRÉ EXTEÉRIEUR

FR_ Transformez votre jardin en un abri nocturne unique et confortable grâce à des luminaires discrets à la lumière chaude ou neutre.

ESTERNO ILLUMINAZIONE A INCASSO

IT_ Trasformate il vostro giardino in un rifugio notturno unico e accogliente con apparecchi discreti a luce calda o neutra.



Image: HATRIA design

Image: PILEA models



PILEA



⊙ Redondo / Round / Rond / Tondo



① 1 salida / 1 output / 1 prise / 1 uscita



② 2 salidas / 2 outputs / 2 prises / 2 uscite

CODE	W	Lm	K	VERSION	BEAM°	VOLTAGE	COLOR	PRICE
61053	1W	85Lm	3000K	⊙	30	220V	INOX ⊙	59,95€
61054	1W	90Lm	4000K	⊙	30	220V	INOX ⊙	59,95€
61056	1W	85Lm	3000K	①	70	220V	INOX ⊙	69,95€
61057	1W	90Lm	4000K	①	70	220V	INOX ⊙	69,95€
61059	1W	85Lm	3000K	②	70	220V	INOX ⊙	69,95€
61060	1W	90Lm	4000K	②	70	220V	INOX ⊙	69,95€

EPISTAR LED CHIP **IP 67** **IK 10** **Alu** **Glass Frosted** **Inox 316** 2500Kg 50 CM **CE** **3** -20 / +50 **Cri>80**

ROUND

1 OUTPUT

2 OUTPUTS

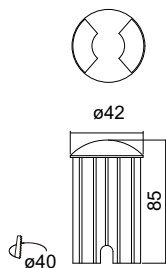
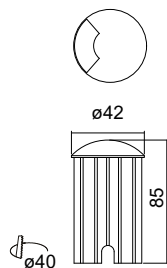
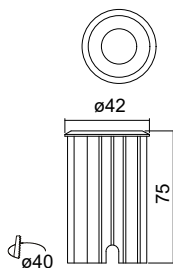

DRAINAGE OF WATER MIN. 30 MM

CIANA



Gu-10 included



○ Redondo / Round / Rond / Tondo

◻ Cuadrado / Square / Carrè / Quadrato

CODE	LAMP	VERSION	COLOR	PRICE
61051	GU-10	○	INOX	54,95€
61052	GU-10	◻	INOX	59,95€

*Lamp not included



ROUND

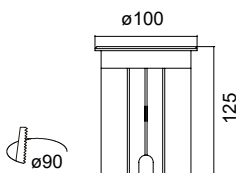

SQUARE

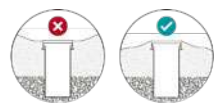
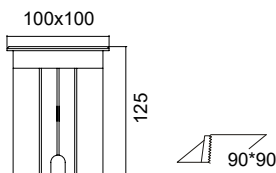

DRAINAGE OF WATER MIN. 30 MM

Se recomienda el uso de la lámpara dicroica SMD de 7,5 W (no incluida). Véase página 255
 The use of the 7.5 W SMD dichroic lamp is recommended (not included). See page 255
 L'utilisation de la lampe dichroïque SMD de 7,5 W est recommandée (non incluse). Voir page 255
 Si consiglia l'uso della lampada dicroica SMD da 7,5 W (non inclusa). Vedere pagina 255

Image: CIANA models

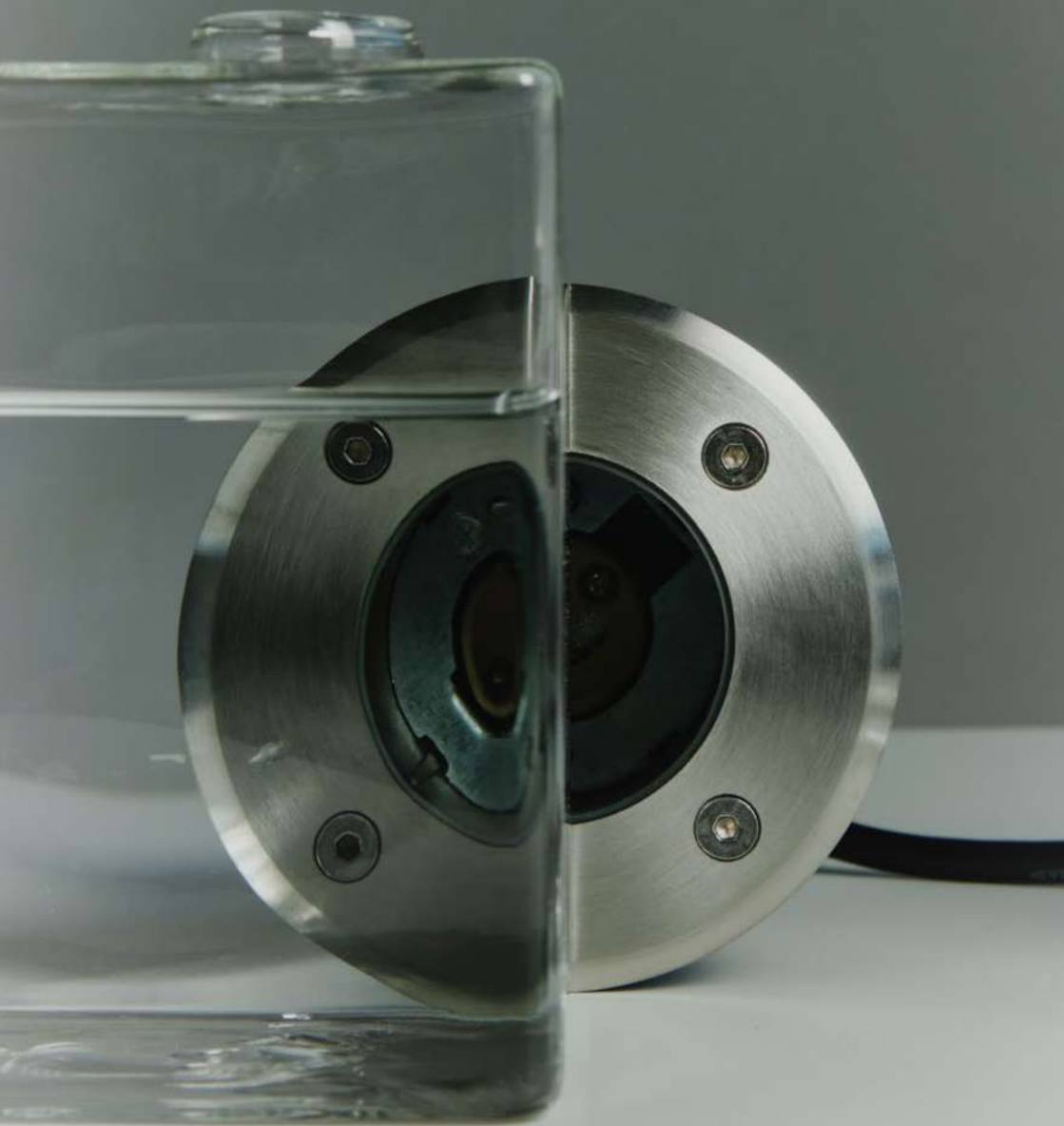



Image: HATRIA models

HATRIA



CODE	W	Lm	K	BEAM°	COLOR	PRICE
61062	6W	510Lm	3000K	30	INOX	109,95€
61063	6W	550Lm	4000K	30	INOX	109,95€
61065	12W	900Lm	3000K	30	INOX	169,95€
61066	12W	960Lm	4000K	30	INOX	169,95€

EPISTAR LED CHIP **IP 67** **IK 09** 220-240V 50/60Hz **Alu** **Glass Frosted** **Inox 316** 2500Kg 50 CM **CE** **3** -20 / +50 **Cri>80**

6W

12W

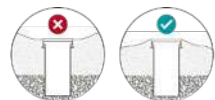
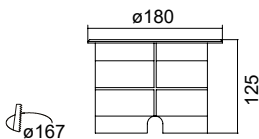
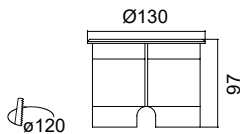

DRAINAGE OF WATER MIN. 30 MM

ANAN

6W-12W

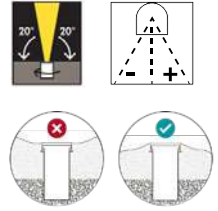

DRAINAGE OF WATER MIN. 30 MM

CODE	W	Lm	K	BEAM°	COLOR	PRICE
62011	6W	570Lm	3000K	15	INOX	299,95€
62012	6W	570Lm	3000K	25	INOX	299,95€
62013	6W	570Lm	3000K	30	INOX	299,95€
62014	6W	570Lm	3000K	45	INOX	299,95€
62015	6W	570Lm	3000K	60	INOX	299,95€
62016	6W	600Lm	4000K	15	INOX	299,95€
62017	6W	600Lm	4000K	25	INOX	299,95€
62018	6W	600Lm	4000K	30	INOX	299,95€
62019	6W	600Lm	4000K	45	INOX	299,95€
62020	6W	600Lm	4000K	60	INOX	299,95€
62026	12W	1140Lm	3000K	15	INOX	494,95€
62027	12W	1140Lm	3000K	25	INOX	494,95€
62028	12W	1140Lm	3000K	30	INOX	494,95€
62029	12W	1140Lm	3000K	45	INOX	494,95€
62030	12W	1140Lm	3000K	60	INOX	494,95€
62031	12W	1200Lm	4000K	15	INOX	494,95€
62032	12W	1200Lm	4000K	25	INOX	494,95€
62033	12W	1200Lm	4000K	30	INOX	494,95€
62034	12W	1200Lm	4000K	45	INOX	494,95€
62035	12W	1200Lm	4000K	60	INOX	494,95€



6W

12W

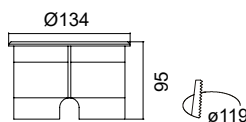
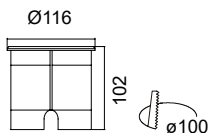

ANAN

18W

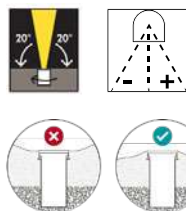

DRAINAGE OF WATER MIN. 30 MM

CODE	W	Lm	K	BEAM°	COLOR	PRICE
62071	18W	1710Lm	3000K	8	INOX ○	749,95€
62072	18W	1710Lm	3000K	10	INOX ○	749,95€
62073	18W	1710Lm	3000K	17	INOX ○	749,95€
62074	18W	1710Lm	3000K	23	INOX ○	749,95€
62075	18W	1710Lm	3000K	28	INOX ○	749,95€
62076	18W	1710Lm	3000K	43	INOX ○	749,95€
62077	18W	1710Lm	3000K	58	INOX ○	749,95€
62078	18W	1710Lm	3000K	95	INOX ○	749,95€
62079	18W	1800Lm	4000K	8	INOX ○	749,95€
62080	18W	1800Lm	4000K	10	INOX ○	749,95€
62081	18W	1800Lm	4000K	17	INOX ○	749,95€
62082	18W	1800Lm	4000K	23	INOX ○	749,95€
62083	18W	1800Lm	4000K	28	INOX ○	749,95€
62084	18W	1800Lm	4000K	43	INOX ○	749,95€
62085	18W	1800Lm	4000K	58	INOX ○	749,95€
62086	18W	1800Lm	4000K	95	INOX ○	749,95€

OSRAM LED DRIVER **IP** 67 **IK** 09 100-240V 50/60Hz **Alu** **Glass Tempered** **Inox 316** 2000kg 3 METRES **Cri>80**

18W

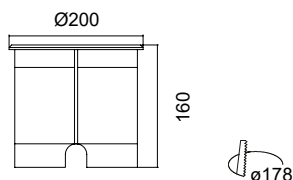

VERA



CODE	W	Lm	K	BEAM°	COLOR	PRICE
61045	6W	570Lm	3000K	120	INOX	199,95€
61046	6W	600Lm	4000K	120	INOX	199,95€



6W

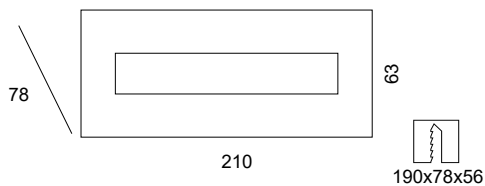

COOPER



CODE	W	Lm	K	BEAM°	COLOR	PRICE
61071	8W	220Lm	3000K	42	A ●	79,95€
61072	8W	240Lm	4000K	42	A ●	79,95€

OSRAM LED DRIVER UGR < 19 **IP** 65 220-240V 50/60Hz **Alu** **Glass Tempered** **CE** -20 / +50 **Cri>80**

8W

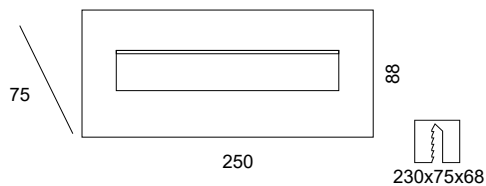

ANDREA



CODE	W	Lm	K	BEAM°	COLOR	PRICE
61480	3W	150Lm	3000K	120	A ●	46,95€
61481	3W	180Lm	4000K	120	A ●	46,95€
61483	9W	450Lm	3000K	120	A ●	77,95€
61484	9W	520Lm	4000K	120	A ●	77,95€
61486	3W	150Lm	3000K	120	B ○	46,95€
61487	3W	180Lm	4000K	120	B ○	46,95€
61489	9W	450Lm	3000K	120	B ○	77,95€
61490	9W	520Lm	4000K	120	B ○	77,95€

UGR < 19

 -20 / +50

3W

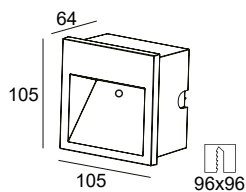

9W

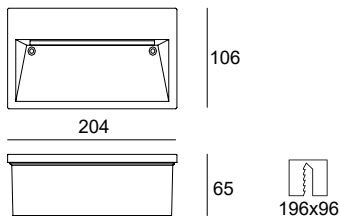



luminaria superficie -exterior



ILUMINACIÓN EXTERIOR SUPERFICIE

ES_ Con materiales resistentes a las variaciones climáticas, esta luminaria garantiza durabilidad y rendimiento con una estética moderna que transforma positivamente el primer contacto visual de cualquier exterior.

OUTDOOR SURFACE LIGHTING

EN_ With materials resistant to climatic variations, this luminaire guarantees durability and performance with a modern aesthetic that positively transforms the first visual contact of any exterior.

ÉCLAIRAGE DE SURFACE EXTÉRIEUR

FR_ Avec des matériaux résistants aux variations climatiques, ce luminaire garantit durabilité et performance avec une esthétique moderne qui transforme positivement le premier contact visuel de tout extérieur.

ILLUMINAZIONE SUPERFICIE ESTERNO

IT_ Con materiali resistenti alle variazioni climatiche, questo apparecchio garantisce durata e prestazioni con un'estetica moderna che trasforma positivamente il primo contatto visivo di qualsiasi esterno.



ARIS



2700 - 3000 - 4000K



CODE	W	Lm	K	BEAM°	COLOR	PRICE
61263	6W	200Lm	3 CCT	120	B ○	49,95€
61264	6W	200Lm	3 CCT	120	A ●	49,95€

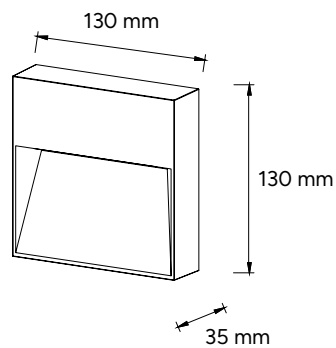
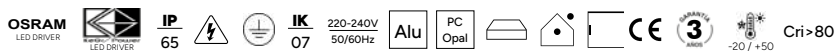

MILO



2700 - 3000 - 4000K



CODE	W	Lm	K	BEAM°	COLOR	PRICE
61266	10W	400Lm	3 CCT	120	B ○	79,95€
61267	10W	400Lm	3 CCT	120	A ●	79,95€

Cri>80

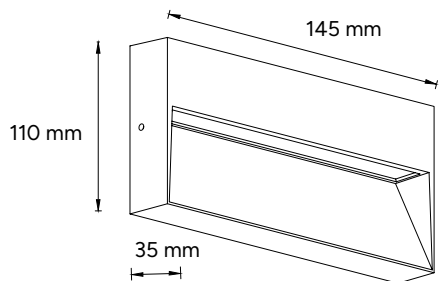

NEIRA



2700 - 3000 - 4000K

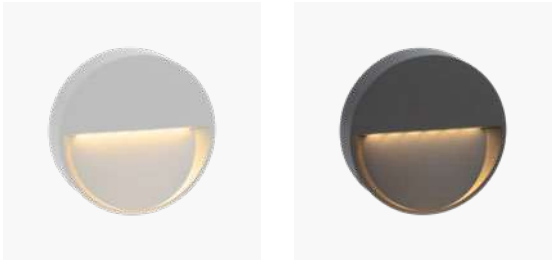

CODE	W	Lm	K	BEAM°	COLOR	PRICE
61260	6W	200Lm	3 CCT	120	B ○	49,95€
61261	6W	200Lm	3 CCT	120	A ●	49,95€

Cri>80

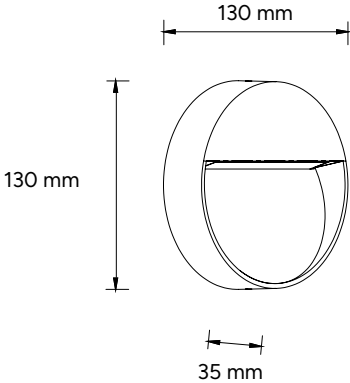



COSMOS



3000 - 4000 - 6000K

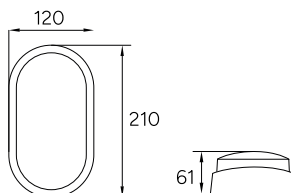

Incluye un aro blanco y otro negro / Includes one white and one black ring / Comprend un anneau blanc et un anneau noir / Include un anello bianco e uno nero

CODE	W	Lm	K	BEAM°	COLOR	PRICE
11306	14W	1400Lm	3 CCT	120	BYN ○●	22,95€

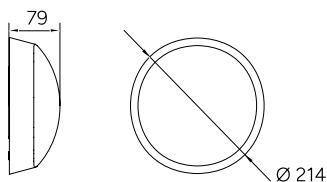

Incluye un aro blanco y otro negro / Includes one white and one black ring / Comprend un anneau blanc et un anneau noir / Include un anello bianco e uno nero

CODE	W	Lm	K	BEAM°	COLOR	PRICE
11307	14W	1400Lm	3 CCT	120	BYN ○●	27,95€



COSMOS



3000 - 4000 - 6000K

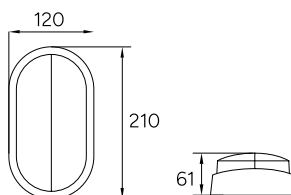

Incluye un aro blanco y otro negro / Includes one white and one black ring / Comprend un anneau blanc et un anneau noir / Include un anello bianco e uno nero

CODE	W	Lm	K	BEAM°	COLOR	PRICE
11308	14W	1400Lm	3 CCT	120	BYN ○●	24,95€

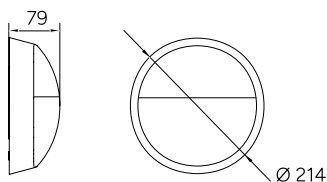

Incluye un aro blanco y otro negro / Includes one white and one black ring / Comprend un anneau blanc et un anneau noir / Include un anello bianco e uno nero

CODE	W	Lm	K	BEAM°	COLOR	PRICE
11309	14W	1400Lm	3 CCT	120	BYN ○●	28,95€



COSMOS



3000 - 4000 - 6000K

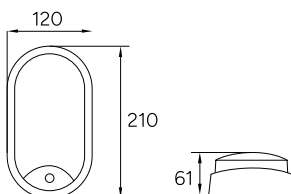

Incluye un aro blanco y otro negro / Includes one white and one black ring / Comprend un anneau blanc et un anneau noir / Include un anello bianco e uno nero

CODE	W	Lm	K	BEAM°	COLOR	PRICE
11310	14W	1400Lm	3 CCT	120	BYN ○●	37,95€

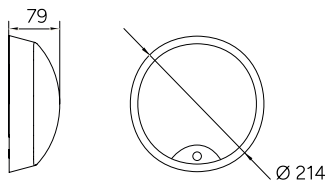

Incluye un aro blanco y otro negro / Includes one white and one black ring / Comprend un anneau blanc et un anneau noir / Include un anello bianco e uno nero

CODE	W	Lm	K	BEAM°	COLOR	PRICE
11311	14W	1400Lm	3 CCT	120	BYN ○●	39,95€



Especificaciones sensor

- Ángulo de detección de 120°
- Distancia de detección 8-10 m
- Tiempo de encendido ajustable de 10 segundos a 5 minutos

Spécifications du capteur

- Angle de détection de 120
- Distance de détection 8-10 m
- Duré d'activation réglable de 10 secondes à 5 minutes

Sensor specifications

- 120° angle of detection
- Detection distance 8-10 m
- Switch-on time adjustable from 10 seconds to 5 mins

Specifiche del sensore

- Angolo di rilevamento di 120°
- Distanza di rilevamento 8-10 m
- Tempo di accensione regolabile da 10 secondi a 5 minuti



SYLAR



CODE	W	Lm	K	BEAM°	COLOR	PRICE
61074	18W	900Lm	3000K	105	A ●	79,95€
61075	18W	940Lm	4000K	105	A ●	79,95€

OSRAM LED DRIVER **IP 65** **IK 07** 220-240V 50/60Hz **Alu** **PC Diffuser** **CE** -30 / +50 **Cri>80**

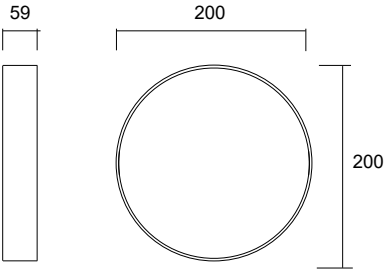

VEGA



CODE	W	Lm	K	BEAM°	COLOR	PRICE
61141	12W	600Lm	3000K	110	A ●	59,95€
61142	12W	640Lm	4000K	110	A ●	59,95€

EVER LIGHT
Led Chip

EAGLE RISE
LED DRIVER

IP
54



IK
06

220-240V
50/60Hz

Alu

PMMA
Diffuser Cover



3
ANSI



-20 / +40

Cri > 80

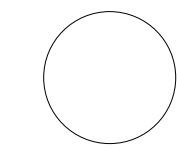
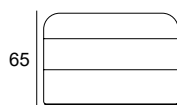

Ø90

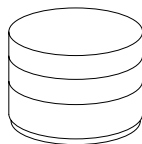



CODE	W	Lm	K	BEAM°	COLOR	DIMMABLE	PRICE
60471	7W	600Lm	3 CCT	45	A ●	ON/OFF	69,95€
60472	7W	600Lm	3 CCT	45	B ○	ON/OFF	69,95€
60473	12W	1020Lm	3 CCT	45	A ●	ON/OFF	99,95€
60474	12W	1020Lm	3 CCT	45	B ○	ON/OFF	99,95€

CREE LED CHIP | **EAGLE RISE** LED DRIVER | **IP65** | **IK07** | UGR < 19 | 220-240V 50/60Hz | **Alu** | Glass Tempered | EM | **CE** | **3** | Smart Control | -20/+50 | **Cri>80**

7W

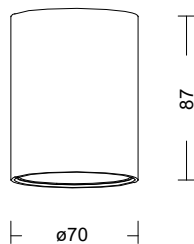

12W

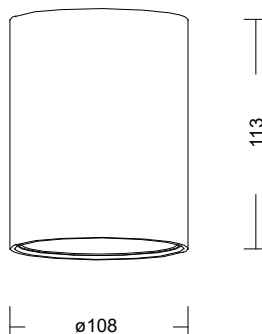





Gu-10 included



① 1 salida / 1 output / 1 prise / 1 uscita

② 2 salidas / 2 outputs / 2 prises / 2 uscite

CODE	LAMP	VERSION	COLOR	PRICE
61124	1xGU-10	①	A ●	39,95€
61127	2xGU-10	②	A ●	49,95€

*Lamp not included

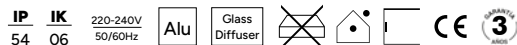

1 OUTPUT

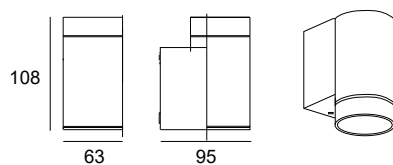

2 OUTPUTS

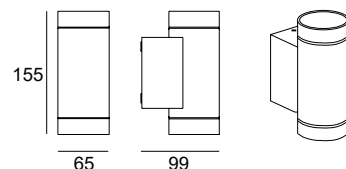

Se recomienda el uso de la lámpara dicroica SMD de 7,5 W (no incluida). Véase página 255
 The use of the 7.5 W SMD dichroic lamp is recommended (not included). See page 255
 L'utilisation de la lampe dichroïque SMD de 7,5 W est recommandée (non incluse). Voir page 255
 Si consiglia l'uso della lampada dicroica SMD da 7,5 W (non inclusa). Vedere pagina 255

DIANA



Gu-10 included



① 1 salida / 1 output / 1 prise / 1 uscita



② 2 salidas / 2 outputs / 2 prises / 2 uscite

CODE	LAMP	VERSION	COLOR	PRICE
61460	1xGU-10	①	A ●	46,95€
61461	2xGU-10	②	A ●	59,95€

*Lamp not included

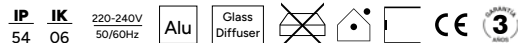

1 OUTPUT

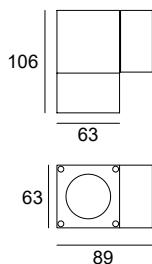

2 OUTPUTS

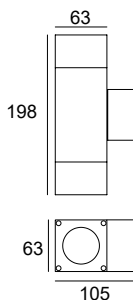

Se recomienda el uso de la lámpara dicroica SMD de 7,5 W (no incluida). Véase página 255
 The use of the 7.5 W SMD dichroic lamp is recommended (not included). See page 255
 L'utilisation de la lampe dichroïque SMD de 7,5 W est recommandée (non incluse). Voir page 255
 Si consiglia l'uso della lampada dicroica SMD da 7,5 W (non inclusa). Vedere pagina 255



MAYA



CODE	W	Lm	K	BEAM°	COLOR	PRICE
61120	12W	850Lm	3000K	110	A ●	99,95€
61121	12W	900Lm	4000K	110	A ●	99,95€

EVER LIGHT
Led Chip

EAGLE RISE
LED DRIVER

IP
54

IK
04



220-240V
50/60Hz

Alu

PMMA
Diffuser Cover



Cri>80

167

139

116

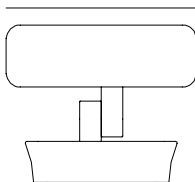
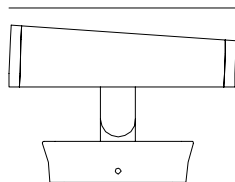

LINUS



CODE	W	Lm	K	BEAM°	COLOR	PRICE
61180	2x4.5W	280Lm	3000K	15-80	A ●	59,95€

CREE LED CHIP
 LED DRIVER
 IP 54

 220-240V 50/60Hz
 Alu
 Glass Tempered

 CE
 3 YEAR WARRANTY
 -20 / +50
 Cri>80

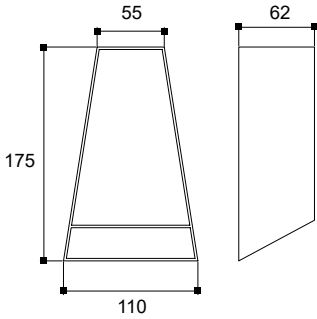





DALIA

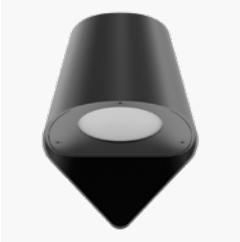

CODE	W	Lm	K	BEAM°	COLOR	PRICE
61177	7W	500Lm	3000K	38	A ●	79,95€
61178	7W	600Lm	4000K	38	A ●	79,95€

CREE LED CHIP
 LED DRIVER
 IP 65

 IK 08
 220-240V / 50/60Hz
 Alu
 Glass Diffuser cover



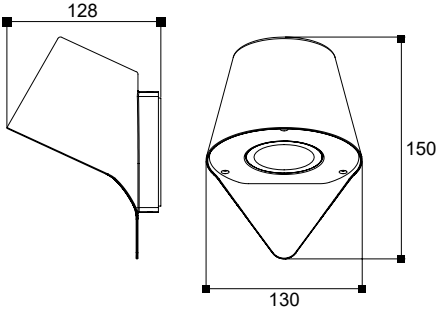





CE
 3 YEARS WARRANTY
 -20 / +50
 Cri>80



NILS



CODE	W	Lm	K	BEAM°	COLOR	PRICE
61159	13W	480Lm	3000K	100	A ●	69,95€
61160	13W	510Lm	4000K	100	A ●	69,95€



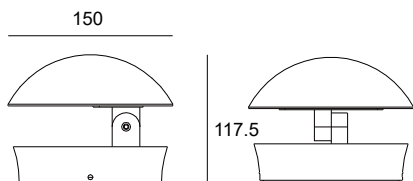









EVER LIGHT Led Chip  **LED DRIVER** **IP 54**   **IK 04** **220-240V 50/60Hz** **Alu** **PMMA Difusser**     **CE** **3**  **Cri>80** **-20/+40**



NEO



CODE	W	Lm	K	BEAM°	COLOR	PRICE
61162	2x6.5W	630Lm	3000K	100	A ●	69,95€
61163	2x6.5W	660Lm	4000K	100	A ●	69,95€

EVER LIGHT  **LED Chip**  **IP** 54   **IK** 06  220-240V 50/60Hz  **Alu**  **PMMA** Difusser       -20 / +50 **Cri>80**

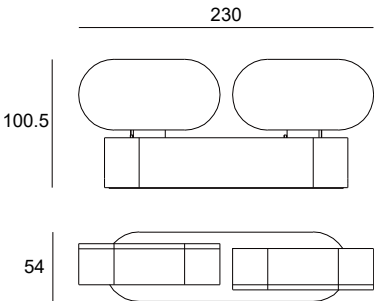



CODE	W	Lm	K	BEAM°	COLOR	PRICE
60920	12W	900Lm	3 CCT	0-100	B ○	69,95€
60921	12W	900Lm	3 CCT	0-100	A ●	69,95€

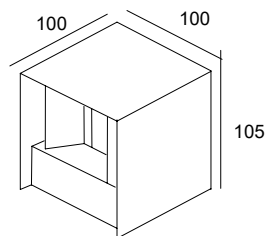
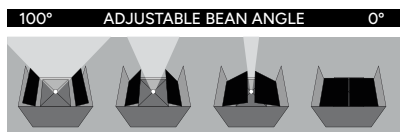
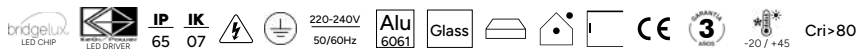

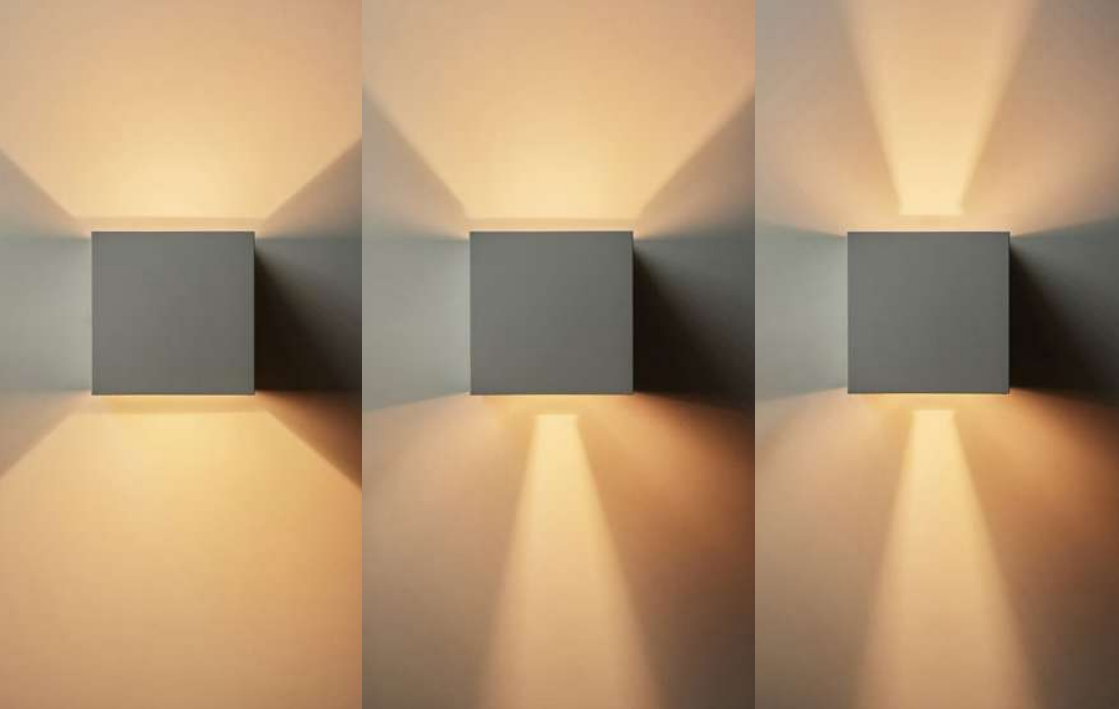



Image: NALIA models

NALIA



2700 - 3000 - 4000K



CODE	W	Lm	K	BEAM°	COLOR	PRICE
61464	7W	510Lm	3 CCT	120	B ○	59,95€
61465	7W	510Lm	3 CCT	120	A ●	59,95€
61466	2x7W	1000Lm	3 CCT	120	B ○	89,95€
61467	2x7W	1000Lm	3 CCT	120	A ●	89,95€
61468	2x12W	1500Lm	3 CCT	120	B ○	159,95€
61469	2x12W	1500Lm	3 CCT	120	A ●	159,95€

CREE LED CHIP **IP65** **220-240V 50/60Hz** **Alu** **Glass Diffuser** **CE** **Cri > 80**

7W

2x7W

2x12W

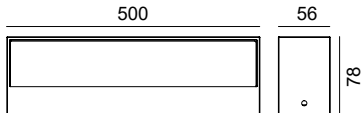
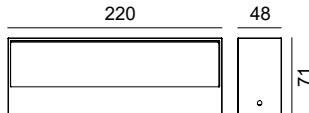
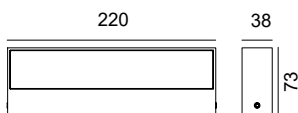

Image: FLORA design



FLORA



① 1 salida / 1 output / 1 prise / 1 uscita



② 2 salidas / 2 outputs / 2 prises / 2 uscite

CODE	W	Lm	K	VERSION	BEAM°	COLOR	PRICE
61291	7W	575Lm	3000K	①	55	A ●	109,95€
61292	7W	600Lm	4000K	①	55	A ●	109,95€
61295	12W	985Lm	3000K	②	55	A ●	119,95€
61296	12W	1000Lm	4000K	②	55	A ●	119,95€

EVER LIGHT
Led Chip

EAGLE RISE
LED DRIVER

IP
65



IK
10

220-245V
50/60Hz

Alu

PC
Diffuser



-20 / +40

Cri>80

7W

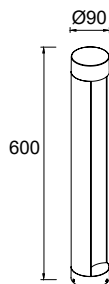

12W

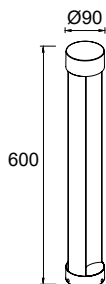











Image: ARIA design

ARIA



CODE	W	Lm	K	BEAM°	COLOR	PRICE
61156	8W	130Lm	3000K	90	A ●	79,95€
61157	8W	160Lm	4000K	90	A ●	79,95€

CREE LED CHIP
EAGLE RISE LED DRIVER
IP 54

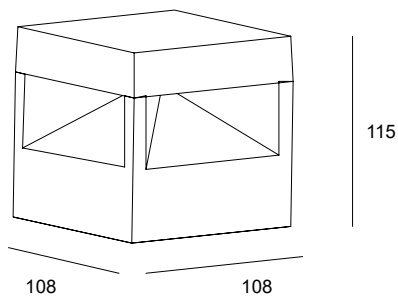
IK 08
220-240V / 50/60Hz
Alu
Glass Diffuser



CE

Cri>80



LEXIE



CODE	W	Lm	K	BEAM°	COLOR	PRICE
61153	8W	150Lm	3000K	90	A ●	69,95€
61154	8W	180Lm	4000K	90	A ●	69,95€

CREE LED CHIP

EAGLE RISE LED DRIVER

IP 54



IK 08

220-240V
50/60Hz

Alu

Glass
Diffuser



CE

3

AMBIENT



-20 / +40

Cri > 80

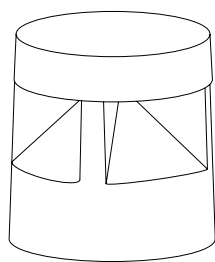

115

Ø108

CARLOTA



CODE	W	Lm	K	BEAM°	COLOR	PRICE
61186	12W	700Lm	3000K	360	A ●	89,95€
61187	12W	750Lm	4000K	360	A ●	89,95€
61189	20W	1000Lm	3000K	360	A ●	149,95€
61190	20W	1100Lm	4000K	360	A ●	149,95€

Cri>80

12W

20W

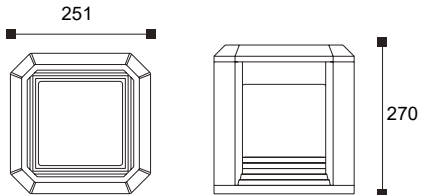
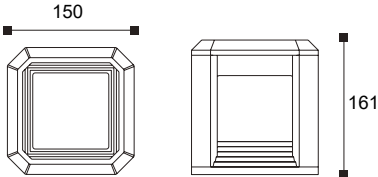

ARNY



⊙ Superficie / Surface /
Superficie



⊙ Estaca / Spike / Enjeu
/ Palo

CODE	W	Lm	K	VERSION	BEAM°	COLOR	PRICE
61080	3W	255Lm	3000K	⊙	36	A ●	39,95€
61081	3W	270Lm	4000K	⊙	36	A ●	39,95€
61083	7W	595Lm	3000K	⊙	36	A ●	49,95€
61084	7W	630Lm	4000K	⊙	36	A ●	49,95€
61086	12W	1020Lm	3000K	⊙	36	A ●	64,95€
61087	12W	1080Lm	4000K	⊙	36	A ●	64,95€
61089	3W	255Lm	3000K	⊙	36	A ●	42,95€
61090	3W	270Lm	4000K	⊙	36	A ●	42,95€
61092	7W	595Lm	3000K	⊙	36	A ●	52,95€
61093	7W	630Lm	4000K	⊙	36	A ●	52,95€
61095	12W	1020Lm	3000K	⊙	36	A ●	68,95€
61096	12W	1080Lm	4000K	⊙	36	A ●	68,95€

CREE LED CHIP **IP 65** 220-240V 50/60Hz **Alu** **Inox 316** **CE** **3** -20 / +40 **Cri>80**

3W

7-12W

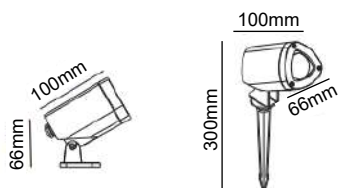
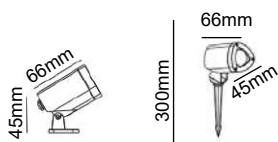





HANA



CODE	W	Lm	K	BEAM°	COLOR	PRICE
61098	3W	240Lm	3000K	10-180	GT ●	89,95€
61099	3W	280Lm	4000K	10-180	GT ●	89,95€

Gris texturizado / Textured grey / Gris texturé / Grigio testurizzato

OSRAM LED DRIVER **IP** 66 **IK** 08   220-240V 50/60Hz **Alu** **Inox 316**    **CE**   -25 / +45 **Cri >80**

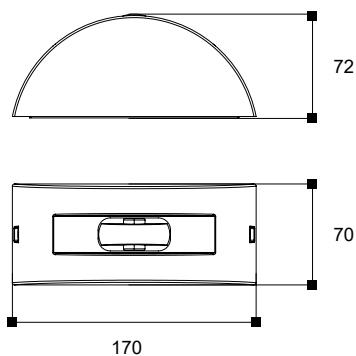

iluminación acuática

ES_ Resalta la belleza del agua para crear un ambiente agradable. EN_ It brings out the beauty of the water to create a pleasant atmosphere. FR_ Il met en valeur la beauté de l'eau pour créer une atmosphère agréable. IT_ Esalta la bellezza dell'acqua per creare un'atmosfera piacevole.



ILUMINACIÓN
SUBACUÁTICA

UNDERWATER
LIGHTING

ÉCLAIRAGE
SOUS-MARIN

SOTT'ACQUA
ILLUMINAZIONE

A tropical pool at night with palm trees and lounge chairs. The pool is illuminated with a bright blue light, and the surrounding area is lit with warm, yellow lights. The sky is a deep purple and blue, suggesting dusk or dawn. The palm trees are silhouetted against the sky, and their fronds are visible. The lounge chairs are arranged in a row along the edge of the pool, and several white umbrellas are closed. The overall atmosphere is serene and relaxing.

Highlighting
the beauty of water.

CAIA



8W _____

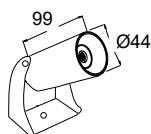

15W _____

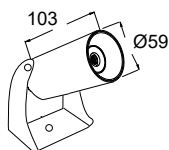

*Power supply not included

CODE	W	Lm	K	BEAM°	COLOR	PRICE
61349	8W	640Lm	4000K	15	INOX	199,95€
61350	8W	640Lm	4000K	24	INOX	199,95€
61351	8W	640Lm	4000K	36	INOX	199,95€
61352	8W	640Lm	4000K	60	INOX	199,95€
61364	15W	1200Lm	4000K	10	INOX	299,95€
61365	15W	1200Lm	4000K	23	INOX	299,95€
61366	15W	1200Lm	4000K	36	INOX	299,95€
61370	15W	900Lm	RGB	10	INOX	349,95€
61371	15W	900Lm	RGB	23	INOX	349,95€
61372	15W	900Lm	RGB	36	INOX	349,95€



RGB CONTROLLER



CODE: 61312

118,95€

CONTROLLER CHARACTERISTICS

- Temperatura de trabajo: -20 / +60°
- Voltaje: DC5V-24V
- Salida: 3 canales
- Modo conexión: Ánodo común
- Dimensión externa: L120xW62xH24mm
- Power: <1W
- Corriente de salida: <8A (cada canal)
- Potencia de salida: 12V: <288W, 24V: <576W

CONTROLLER OPTIONS

88500	P.461
88502	P.462
88552	P.464

COMMAND CHARACTERISTICS

- Temperatura de trabajo: -20 / +60°
- Fuente de alimentación: AAA*3
- Voltaje de suministro: 1.5V*3
- Frecuencia de transmisión: 2.4Ghz
- Consumo de energía en espera: 0.015mW
- Corriente de espera: 60uA
- Corriente de trabajo: 200uA
- Corriente de emisión: 1 OmA
- Distancia de remate: unos 30 m
- Tiempo en espera: 6 meses

CONTROLLER OPTIONS

88516	P.481
88509	P.484

ARALE



6W

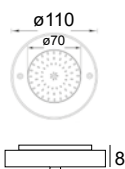

24W

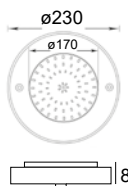

CODE	W	Lm	K	BEAM°	COLOR	PRICE
61306	6W	480Lm	6000K	120	INOX	149,95€
61307	6W	180Lm	RGB	120	INOX	159,95€
61310	24W	1920Lm	6000K	120	INOX	249,95€
61311	24W	800Lm	RGB	120	INOX	269,95€

*Power supply not included

EPISTAR
LED CHIP

IP
68

IK
07

DC 12V

Alu

Inox
316

Resin
Cover

2 METRES



CE

3

Smart Control

-20 / +40

Cri>80

RGB CONTROLLER



CODE: 61312

118,95€

CONTROLLER CHARACTERISTICS

- Temperatura de trabajo: -20 / +60°
- Voltaje: DC5V-24V
- Salida: 3 canales
- Modo conexión: Ánodo común
- Dimensión externa: L120xW62xH24mm
- Power: <1W
- Corriente de salida: <8A (cada canal)
- Potencia de salida: 12V: <288W, 24V: <576W

CONTROLLER OPTIONS

88500	P.461
88502	P.462
88552	P.464

COMMAND CHARACTERISTICS

- Temperatura de trabajo: -20 / +60°
- Fuente de alimentación: AAA*3
- Voltaje de suministro: 1.5V*3
- Frecuencia de transmisión: 2.4Ghz
- Consumo de energía en espera: 0.015mW
- Corriente de espera: 60uA
- Corriente de trabajo: 200uA
- Corriente de emisión: 1 OmA
- Distancia de remate: unos 30 m
- Tiempo en espera: 6 meses

CONTROLLER OPTIONS

88516	P.481
88509	P.484

dicroica GU-10



ES_ La dicroica GU10 es un clásico renovado: eficiente, compacta y perfecta para iluminación puntual. Su haz definido y su fácil instalación la hacen ideal para resaltar espacios y crear ambientes en cualquier proyecto. **EN_** The GU10 dichroic lamp is a renewed classic: efficient, compact, and perfect for focused lighting. Its defined beam and easy installation make it ideal for highlighting spaces and creating ambience in any project. **FR_** La lampe dichroïque GU10 est un classique revisité : efficace, compacte et parfaite pour l'éclairage ponctuel. Son faisceau précis et son installation simple en font la solution idéale pour mettre en valeur les espaces et créer des ambiances dans tout projet. **IT_** La lampada dicroica GU10 è un classico rinnovato: efficiente, compatta e perfetta per l'illuminazione puntuale. Il suo fascio definito e la facile installazione la rendono ideale per valorizzare gli spazi e creare atmosfera in qualsiasi progetto.

GU-10



CODE	W	Lm	K	Ø	BEAM°	DIMMABLE	PRICE
10220	7.5W	600Lm	2700K	50 mm	38	ON/OFF	4,45€
10221	7.5W	620Lm	3000K	50 mm	38	ON/OFF	4,45€
10222	7.5W	640Lm	4000K	50 mm	38	ON/OFF	4,45€
10224	7.5W	600Lm	2700K	50 mm	38	DIMMABLE	8,95€
10225	7.5W	620Lm	3000K	50 mm	38	DIMMABLE	8,95€
10226	7.5W	640Lm	4000K	50 mm	38	DIMMABLE	8,95€





led profile



indoor series

ES_ Tecnología LED lineal flexible para iluminación de uso interior a nivel profesional, donde se presentan distintas opciones en potencias, temperaturas de color, reproducción cromática y siempre con altas prestaciones en eficiencia energética.

EN_ Flexible linear LED technology, for interior lighting at a professional level, where different options are presented in powers, color temperatures, color rendering and always with high performance in energy efficiency.

FR_ Technologie LED linéaire flexible, pour l'éclairage intérieur à un niveau professionnel, où différentes options sont présentées dans les puissances, les températures de couleur, le rendu des couleurs et toujours avec des performances élevées en matière d'efficacité énergétique.

IT_ Tecnologia LED lineare flessibile per l'illuminazione di interni a livello professionale, con diverse opzioni in termini di potenza, temperatura di colore, resa cromatica e resa cromatica, sempre con un'elevata efficienza energetica.



SANTORINI

4.8W/m · IP20 · 24V · CRI>80

Power 4.8 W/m
Life Time 75.000 h
PCB Thickness 3 oz

Voltage 24V
CRI >80
SDMC ≤3

CODE	CCT (K)	LUMEN OUTPUT	Lm/W	PRICE
83991	2700K	432 Lm/M	90 Lm/W	6,95€
83992	3000K	437 Lm/M	91 Lm/W	6,95€
83993	4000K	447 Lm/M	93 Lm/W	6,95€
83994	6000K	456 Lm/M	95 Lm/W	6,95€

LED SMD 2835
30 m
120 LED/m
IP 20

Test LM 80
50 mm
120°
Non Flicker

Importante instalar disipador de calor / Important to install heat sink / Important d'installer le dissipateur de chaleur / Importante installare il dissipatore di calore

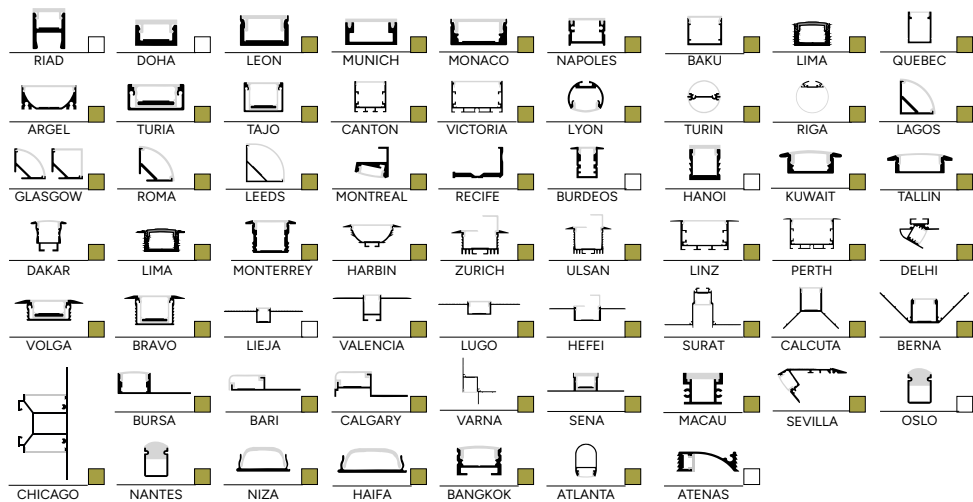

■ Compatible / Compatibile No compatible / Not compatible / Non compatible / Non compatibile

AUSTIN



7W/m · IP20 · 24V · CRI>80

Power 7 W/m
Life Time 75.000 h
PCB Thickness 3 oz

Voltage 24V
CRI >80
SDMC ≤3

CODE	CCT (K)	LUMEN OUTPUT	Lm/W	PRICE
86070	2700K	658 Lm/M	94 Lm/W	14,95€
86071	3000K	665 Lm/M	95 Lm/W	14,95€
86072	4000K	679 Lm/M	97 Lm/W	14,95€
86073	6000K	700 Lm/M	100 Lm/W	14,95€

LED COB 30 m
Test LM80 62.5 mm

512 LED/m
120°

IP 20
Non Flicker

Importante instalar disipador de calor / Important to install heat sink / Important d'installer le dissipateur de chaleur / Importante installare il dissipatore di calore

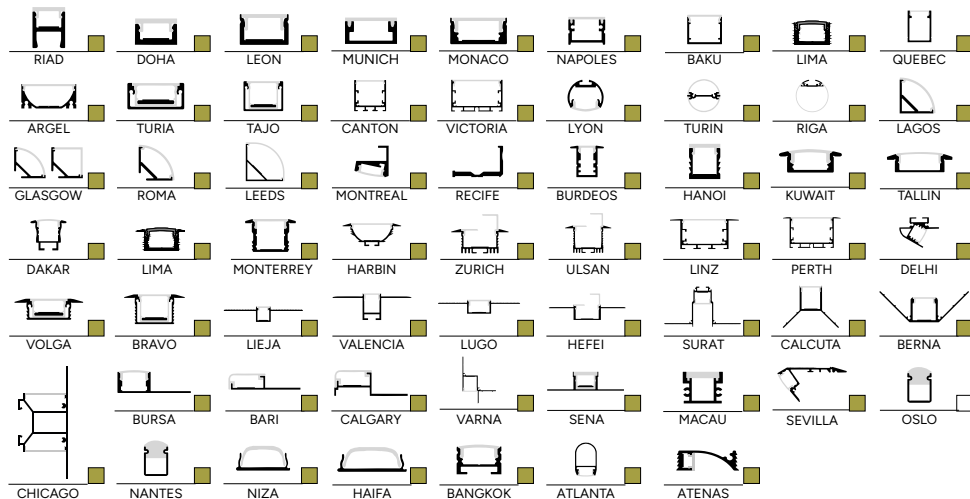

Compatible / Compatibile No compatible / Not compatible / Non compatibile / Non compatibile

MIAMI

9.6W/m · IP20 · 24V · CRI>80

Power	Life Time	PCB Thickness	CODE	CCT (K)	LUMEN OUTPUT	Lm/W	M	PRICE
9.6 W/m	75.000 h	3 oz	86000	2200K	1240 Lm/M	129 Lm/W	1 m/L	7,95€
			84000	2700K	1258 Lm/M	131 Lm/W	1 m/L	7,95€
Voltage	CRI	SDMC	84001	3000K	1277 Lm/M	133 Lm/W	1 m/L	7,95€
24V	>80	≤3	84002	4000K	1296 Lm/M	135 Lm/W	1 m/L	7,95€
			84003	6000K	1344 Lm/M	140 Lm/W	1 m/L	7,95€
			80521	2700K	1258 Lm/M	131 Lm/W	5 m Roll	39,75€
			80522	3000K	1277 Lm/M	133 Lm/W	5 m Roll	39,75€
			80523	4000K	1296 Lm/M	135 Lm/W	5 m Roll	39,75€
			80524	6000K	1344 Lm/M	140 Lm/W	5 m Roll	39,75€

LED SMD
2835

Test
LM 80

5-30 m

50 mm

140 LED/m

120°

IP
20

Non
Flicker

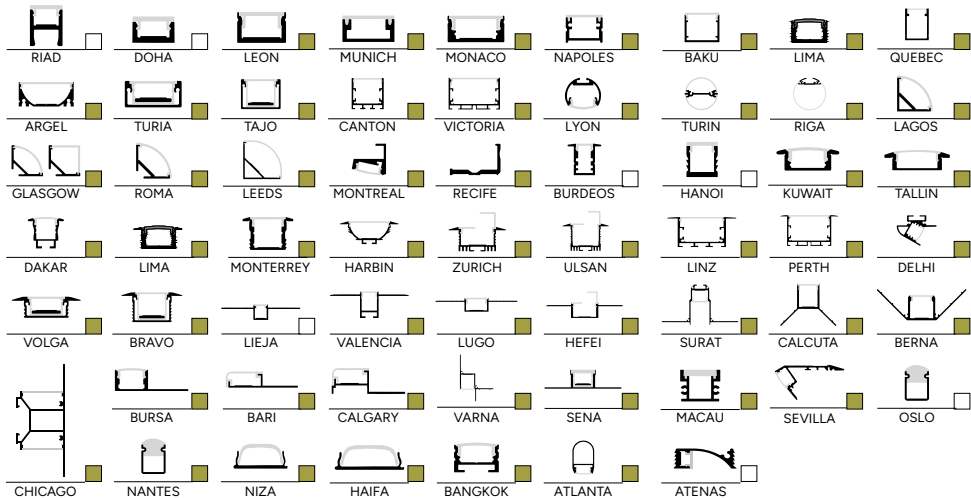

Compatible / Compatibile No compatible / Not compatible / Non compatible / Non compatibile

BRISTOL



12W/m · IP20 · 24V · CRI>80

Power	Life Time	PCB Thickness	CODE	CCT (K)	LUMEN OUTPUT	Lm/W	PRICE
12 W/m	75.000 h	3 oz	86060	2700K	1404 Lm/M	117 Lm/W	11,95€
			86061	3000K	1440 Lm/M	120 Lm/W	11,95€
Voltage	CRI	SDMC	86062	4000K	1476 Lm/M	123 Lm/W	11,95€
24V	>80	≤3	86063	6000K	1500 Lm/M	125 Lm/W	11,95€

LED SMD 2835	30 m	140 LED/m	IP 20	
Test LM 80	50 mm	120°	Non Flicker	

Importante instalar disipador de calor / Important to install heat sink / Important d'installer le dissipateur de chaleur / Importante installare il dissipatore di calore

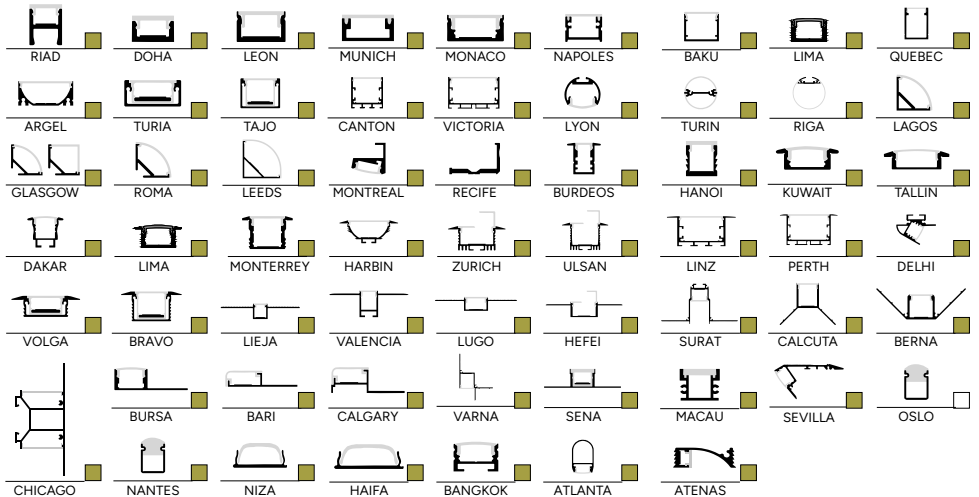

Compatible / Compatibile No compatible / Not compatible / Non compatible / Non compatibile

OREGÓN

12W/m · IP20 · 24V · CRI>80

Power 12 W/m
Life Time 75.000 h
PCB Thickness 3 oz

Voltage 24V
CRI >80
SDMC ≤3

CODE	CCT (K)	LUMEN OUTPUT	Lm/W	PRICE
86031	2700K	1560 Lm/M	130 Lm/W	9,95€
80032	3000K	1600 Lm/M	133 Lm/W	9,95€
80033	4000K	1640 Lm/M	136 Lm/W	9,95€
80034	6000K	1680 Lm/M	140 Lm/W	9,95€

LED SMD 2835
30 m
112 LED/m
IP 20
Non Flicker

Test LM80
62.5 mm
120°

Importante instalar disipador de calor / Important to install heat sink / Important d'installer le dissipateur de chaleur / Importante installare il dissipatore di calore

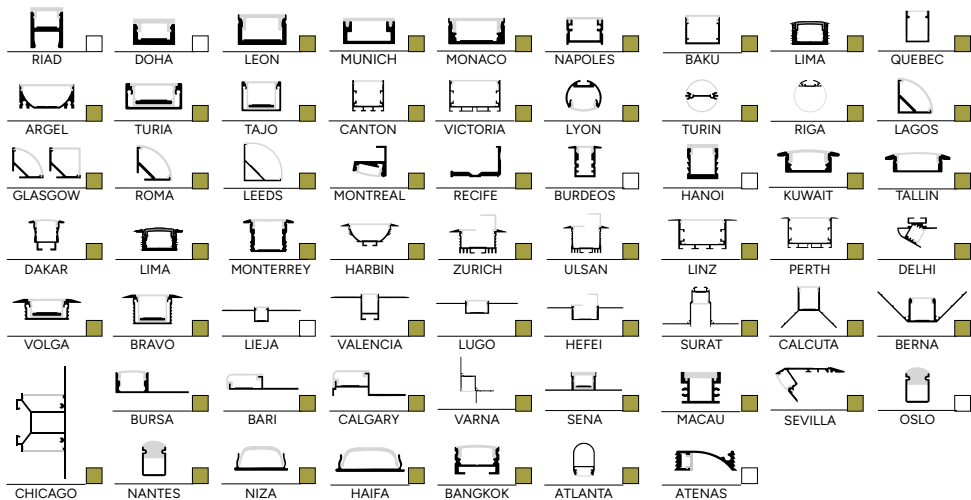

Compatible / Compatibile No compatible / Not compatible / Non compatible / Non compatibile

CALIFORNIA

12W/m · IP20 · 24V · CRI>90

Power	Life Time	PCB Thickness	CODE	CCT (K)	LUMEN OUTPUT	Lm/W	PRICE
12 W/m	75.000 h	3 oz	86079	2200K	1000 Lm/M	84 Lm/W	12,95€
			84080	2700K	1050 Lm/M	88 Lm/W	12,95€
			84081	3000K	1120 Lm/M	93 Lm/W	12,95€
			84082	4000K	1200 Lm/M	100 Lm/W	12,95€
			84083	6000K	1280 Lm/M	106 Lm/W	12,95€

Voltage	CRI	SDMC
24V	>90	≤3

LED COB	30 m	480 LED/m	IP 20	<p>10 mm</p> <p>50 mm</p> <p>30 m</p> <p>Max length 10m</p> <p>1.9 mm</p>
Test LM 80	50 mm	120°	Non Flicker	

Importante instalar disipador de calor / Important to install heat sink / Important d'installer le dissipateur de chaleur / Importante installare il dissipatore di calore

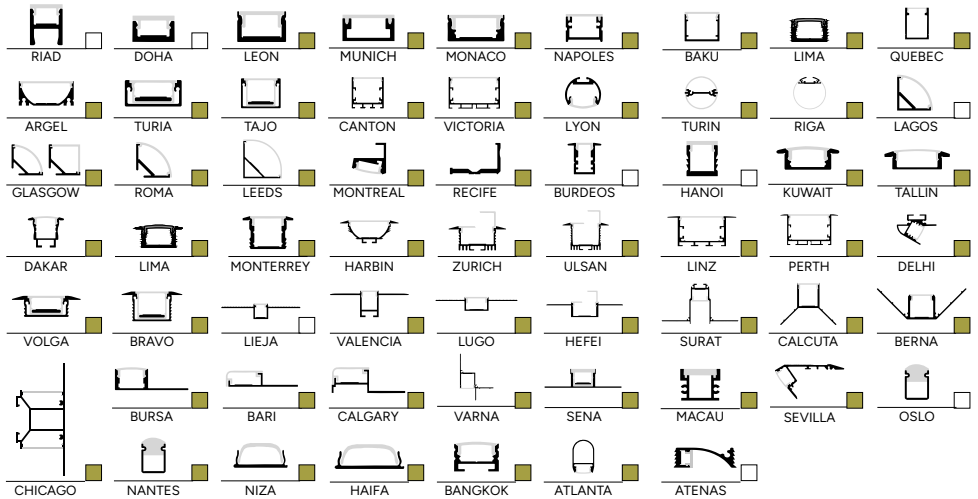

Compatible / Compatibile No compatible / Not compatible / Non compatible / Non compatibile

MISURI

14.4W/m · IP20 · 24V · CRI>80

Power 14.4 W/m
Life Time 75.000 h
PCB Thickness 3 oz

Voltage 24V
CRI >80
SDMC ≤3

CODE	CCT (K)	LUMEN OUTPUT	Lm/W	M	PRICE
84941	2700K	1325 Lm/M	92 Lm/W	1 m/L	6,95€
84942	3000K	1354 Lm/M	94 Lm/W	1 m/L	6,95€
84943	4000K	1397 Lm/M	97 Lm/W	1 m/L	6,95€
84944	6000K	1440 Lm/M	100 Lm/W	1 m/L	6,95€
84946	2700K	1325 Lm/M	92 Lm/W	5 m Roll	32,95€
84947	3000K	1354 Lm/M	94 Lm/W	5 m Roll	32,95€
84948	4000K	1397 Lm/M	97 Lm/W	5 m Roll	32,95€
84949	6000K	1440 Lm/M	100 Lm/W	5 m Roll	32,95€

LED SMD 2835
5-30 m
Test LM 80

5-30 m
120 LED/m
50 mm

IP 20
Non Flicker

Importante instalar disipador de calor / Important to install heat sink / Important d'installer le dissipateur de chaleur / Importante installare il dissipatore di calore

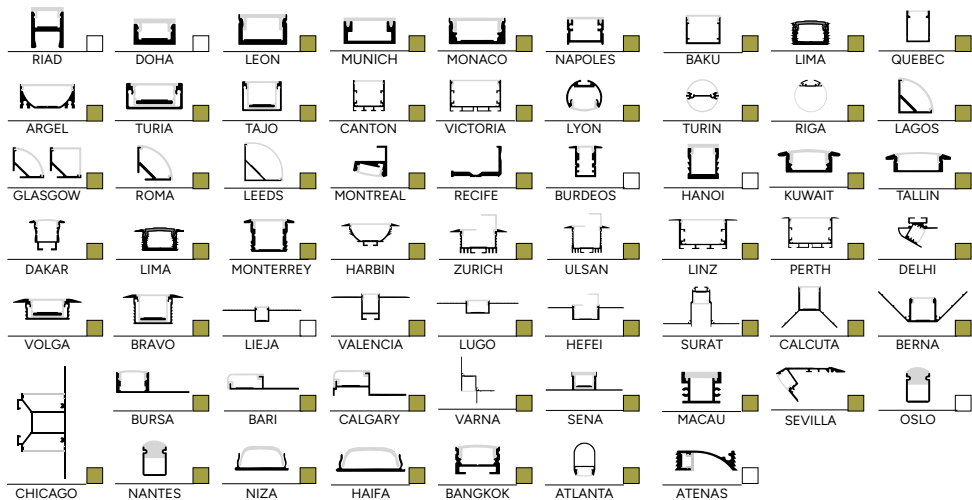

*m/L: Lineal meter

Compatible / Compatibile No compatible / Not compatible / Non compatible / Non compatibile

ORLANDO

NEW PRODUCT

14.4W/m · IP20 · 24V · CRI>80

Power 14.4 W/m Life Time 75.000 h PCB Thickness 3 oz

Voltage 24V CRI >80 SDMC ≤3

CODE	CCT (K)	LUMEN OUTPUT	Lm/W	PRICE
86006	2200K	1800 Lm/M	125 Lm/W	12,95€
84007	2700K	1886 Lm/M	131 Lm/W	12,95€
84008	3000K	1915 Lm/M	133 Lm/W	12,95€
84009	4000K	1959 Lm/M	135 Lm/W	12,95€
84010	6000K	2016 Lm/M	140 Lm/W	12,95€
84970	Red	495 Lm/M	35 Lm/W	14,95€
84971	Blue	375 Lm/M	26 Lm/W	12,95€
84972	Green	1990 Lm/M	138 Lm/W	14,95€
84973	Yellow	1890 Lm/M	131 Lm/W	16,95€
84974	Pink	1150 Lm/M	80 Lm/W	16,95€

LED SMD 2835 30 m

Test LM 80 33.3 mm

210 LED/m

120°

IP 20

Non Flicker

Importante instalar disipador de calor / Important to install heat sink / Important d'installer le dissipateur de chaleur / Importante installare il dissipatore di calore

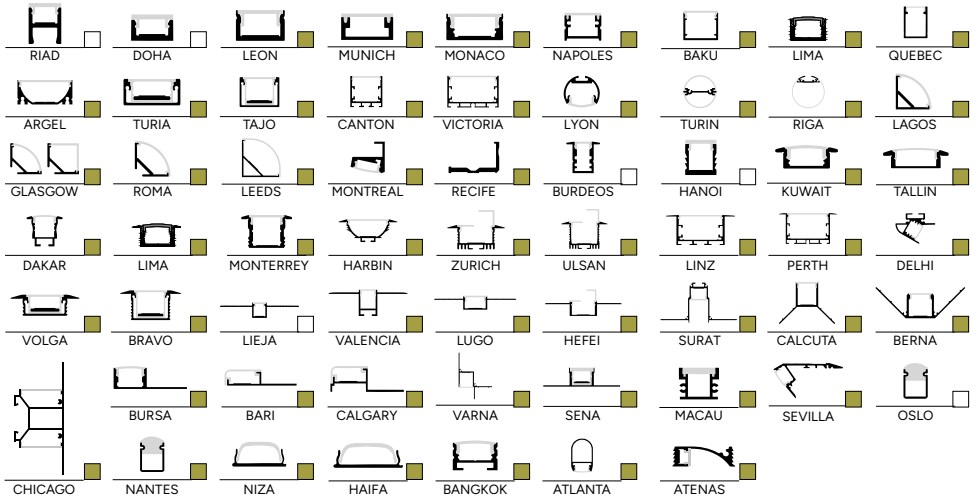

Compatible / Compatibile No compatible / Not compatible / Non compatible / Non compatibile

DENVER

19.2W/m · IP20 · 24V · CRI>80

Power	Life Time	PCB Thickness	CODE	CCT (K)	LUMEN OUTPUT	Lm/W	PRICE
19.2 W/m	75.000 h	3 oz	84014	2700K	2515 Lm/M	131 Lm/W	15,95€
			84015	3000K	2553 Lm/M	133 Lm/W	15,95€
Voltage	CRI	SDMC	84016	4000K	2592 Lm/M	135 Lm/W	15,95€
24V	>80	≤3	84017	6000K	2688 Lm/M	140 Lm/W	15,95€

LED SMD 2835	30 m	238 LED/m	IP 20	
Test LM 80	29.4 mm	120°	Non Flicker	

Importante instalar disipador de calor / Important to install heat sink / Important d'installer le dissipateur de chaleur / Importante installare il dissipatore di calore

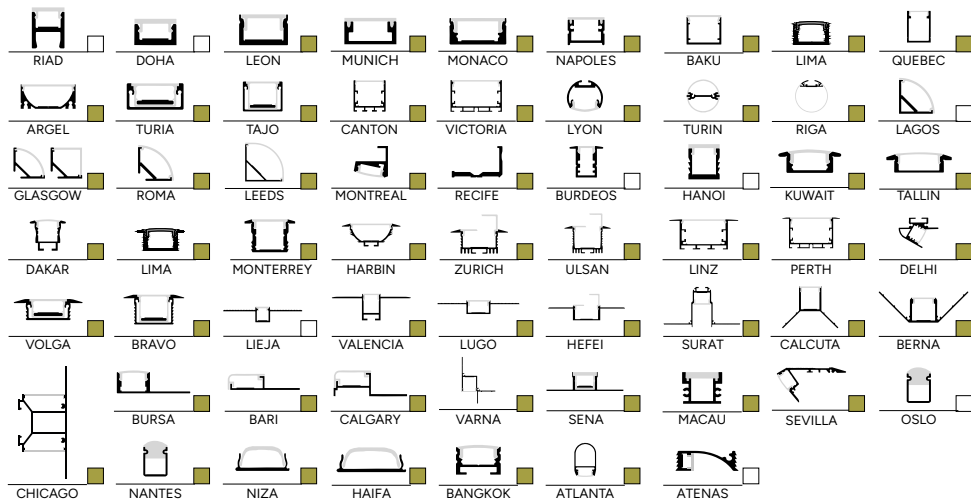

Compatible / Compatibile No compatible / Not compatible / Non compatible / Non compatibile

DETROIT

24W/m · IP20 · 24V · CRI>80

Power	Life Time	PCB Thickness	CODE	CCT (K)	LUMEN OUTPUT	Lm/W	PRICE
24 W/m	75.000 h	3 oz	84021	2700K	2640 Lm/M	110 Lm/W	16,95€
			84022	3000K	2688 Lm/M	112 Lm/W	16,95€
Voltage	CRI	SDMC	84023	4000K	2760 Lm/M	115 Lm/W	16,95€
24V	>80	≤3	84024	6000K	2880 Lm/M	120 Lm/W	16,95€

LED SMD 2835	30 m	240 LED/m	IP 20	
Test LM80	25 mm	120°	Non Flicker	

Importante instalar disipador de calor / Important to install heat sink / Important d'installer le dissipateur de chaleur / Importante installare il dissipatore di calore

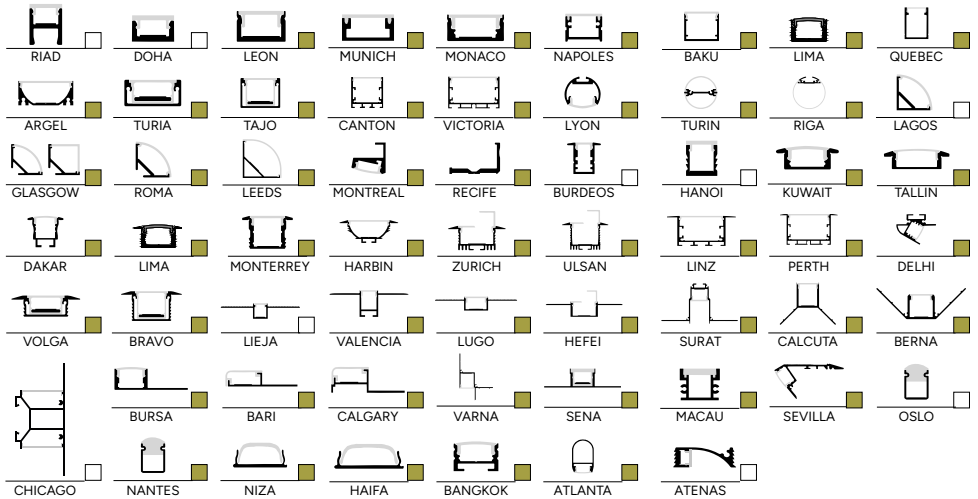

Compatible / Compatibile No compatible / Not compatible / Non compatible / Non compatibile

KANSAS

48W/m · IP20 · 24V · CRI>80

Power	Life Time	PCB Thickness	CODE	CCT (K)	LUMEN OUTPUT	Lm/W	PRICE
48 W/m	75.000 h	3 oz	84028	2700K	4800 Lm/M	100 Lm/W	19,95€
			84029	3000K	4992 Lm/M	104 Lm/W	19,95€
Voltage	CRI	SDMC	84030	4000K	5088 Lm/M	106 Lm/W	19,95€
24V	>80	≤3	84031	6000K	5280 Lm/M	110 Lm/W	19,95€

LED SMD 2835	30 m	240 LED/m	IP 20	
Test LM80	25 mm	120°	Non Flicker	

Importante instalar disipador de calor / Important to install heat sink / Important d'installer le dissipateur de chaleur / Importante installare il dissipatore di calore

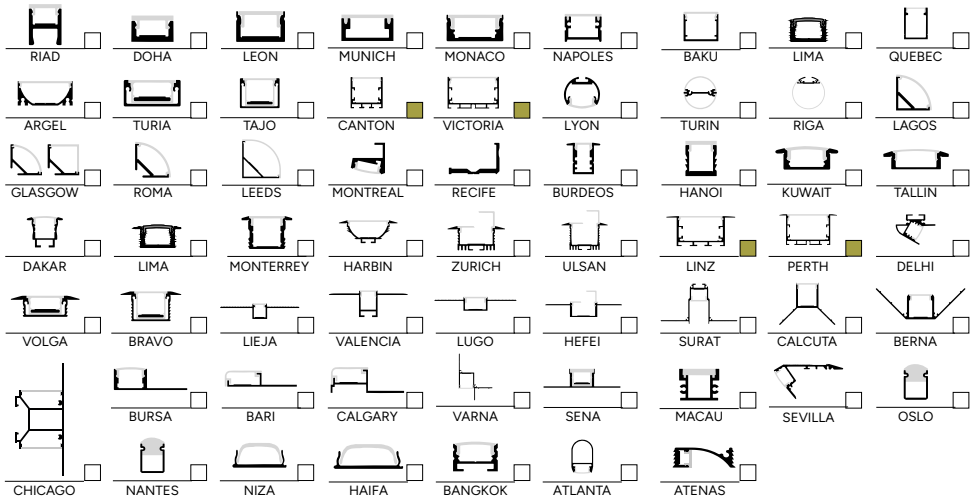

Compatible / Compatibile No compatible / Not compatible / Non compatible / Non compatibile

MADISON

RGB

12W/m · IP20 · 24V · CRI>90

Power 12 W/m Life Time 75.000 h PCB Thickness 3 oz

CODE	CCT (K)	LUMEN OUTPUT	Lm/W	PRICE
86050	RGB	495 Lm/M	41 Lm/W	19,95€

Voltage 24V SDMC
 ≤3



Importante instalar disipador de calor / Important to install heat sink / Important d'installer le dissipateur de chaleur / Importante installare il dissipatore di calore

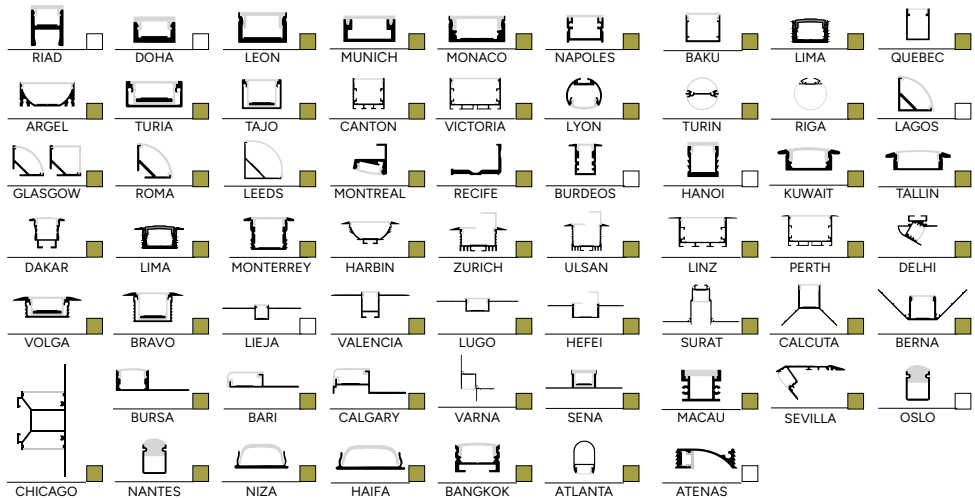

Compatible / Compatibile No compatible / Not compatible / Non compatible / Non compatibile

ALASKA

RGB

14.4W/m · IP20 · 24V · CRI>80

Power 14.4 W/m
Life Time 75.000 h
PCB Thickness 3 oz

CODE	CCT (K)	LUMEN OUTPUT	M	PRICE
84960	RGB	540 Lm/M	1 m/L	10,95€
84961	RGB	540 Lm/M	5 m Roll	59,95€

Voltage 24V
SDMC ≤3

LED SMD 5050 RGB
5-30 m
120 LED/m
100 mm
120°

IP 20
Non Flicker

Importante instalar disipador de calor / Important to install heat sink / Important d'installer le dissipateur de chaleur / Importante installare il dissipatore di calore

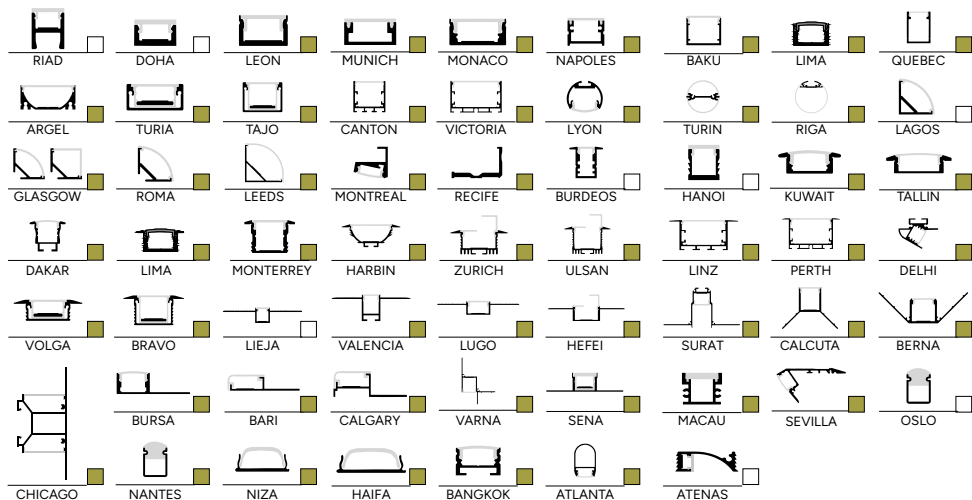

*m/L: Lineal meter

Compatible / Compatibile No compatible / Not compatible / Non compatible / Non compatibile

DAYTON

RGB+W

15W/m · IP20 · 24V · CRI>90

Power 15 W/m Life Time 75.000 h PCB Thickness 3 oz

Voltage 24V SDCM ≤3

CODE	CCT (K)	LUMEN OUTPUT	PRICE
86052	3000K	646 Lm/M	23,95€
86053	4000K	675 Lm/M	23,95€



Importante instalar disipador de calor / Important to install heat sink / Important d'installer le dissipateur de chaleur / Importante installare il dissipatore di calore

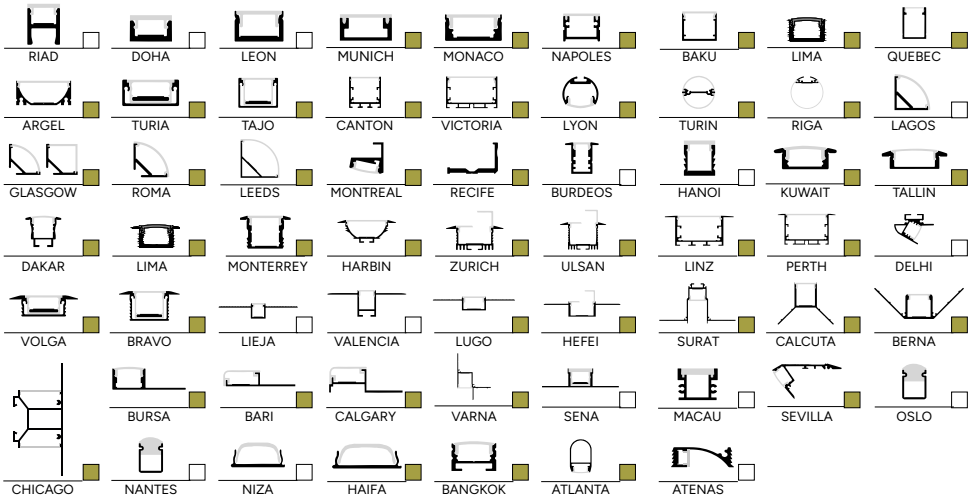
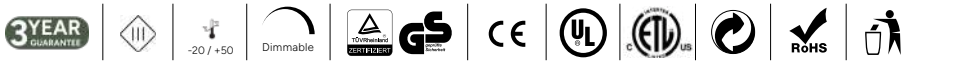

Compatible / Compatibile No compatible / Not compatible / Non compatibile / Non compatibile

TORONTO

RGB+CCT

26.4W/m · IP20 · 24V

Power 26.4 W/m Life Time 75.000 h PCB Thickness 3 oz

Voltage 24V SDMC
 ≤ 3

CODE	CCT (K)	LUMEN OUTPUT	PRICE
	RGB+CCT	600 Lm/M	
84047	3000K	480 Lm/M	24,95€
	6000K	600 Lm/M	

LED SMD
5050+2016
RGB DUAL

IP
20

Non Flicker

20 m 180 LED/m 100 mm

Importante instalar disipador de calor / Important to install heat sink / Important d'installer le dissipateur de chaleur / Importante installare il dissipatore di calore

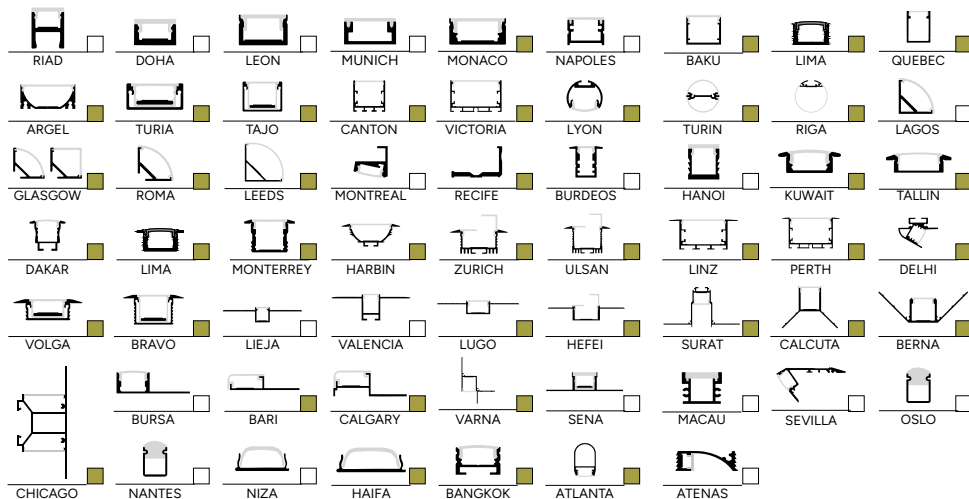

■ Compatible / Compatibile □ No compatible / Not compatible / Non compatible / Non compatibile

GEORGIA

TUNEABLE WHITE 19.2W/m · IP20 · 24V · CRI>90

Power 19.2 W/m Life Time 75.000 h PCB Thickness 3 oz

CODE	CCT (K)	LUMEN OUTPUT	PRICE
84044	○+● 1800-6500K Dimmable	2160 Lm/M	19,95€

Voltage 24V CRI >90 SDMC ≤3

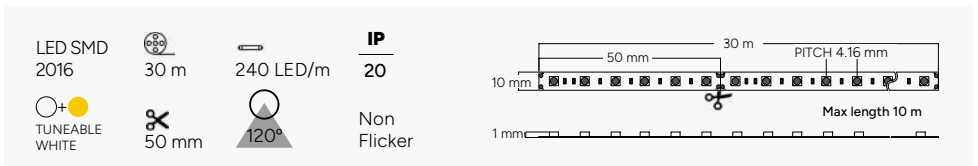

Importante instalar disipador de calor / Important to install heat sink / Important d'installer le dissipateur de chaleur / Importante installare il dissipatore di calore

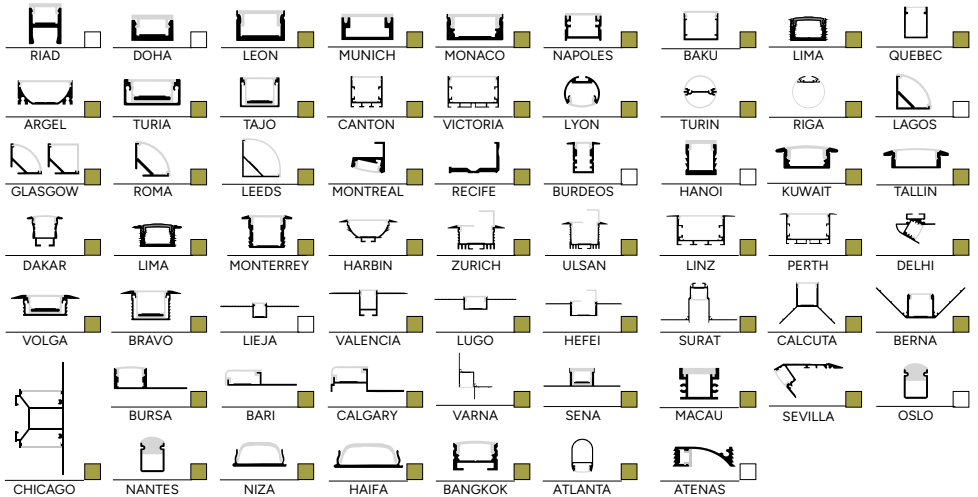

Compatible / Compatibile No compatible / Not compatible / Non compatible / Non compatibile

tira flexible



FLEXIBLE STRIP / BANDE FLEXI / CINGHIA FLESSIBILE

MICHIGAN





14.4W/m · IP20 · 24V · CRI>80

Power 14.4 W/m
Life Time 75.000 h
PCB Thickness 3 oz

Voltage 24V
CRI >80
SDMC ≤3

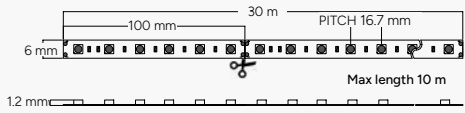

CODE	CCT (K)	LUMEN OUTPUT	Lm/W	PRICE
84074	2700K	1296 Lm/M	90 Lm/W	12,95€
84075	3000K	1368 Lm/M	95 Lm/W	12,95€
84076	4000K	1440 Lm/M	100 Lm/W	12,95€

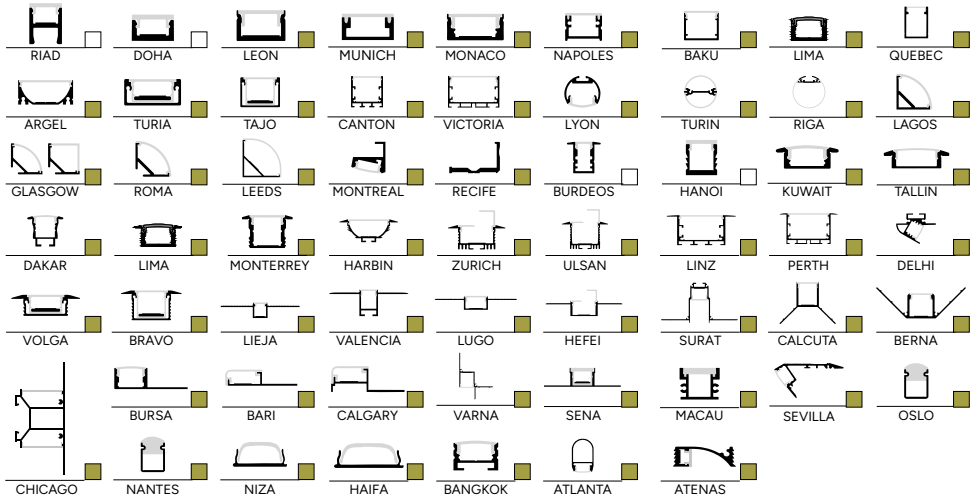

LED SMD 2835	 30 m	 60 LED/m	IP 20	
Test LM80	 100 mm	 120°	Non Flicker	

Importante instalar disipador de calor / Important to install heat sink / Important d'installer le dissipateur de chaleur / Importante installare il dissipatore di calore



 Compatible / Compatibile  No compatible / Not compatible / Non compatible



48V

VANCOUVER

Max 20 m
continuous line

10W/m · IP20 · 48V · CRI>80

Power	Life Time	PCB Thickness	CODE	CCT (K)	LUMEN OUTPUT	Lm/W	PRICE
10 W/m	75.000 h	3 oz	84809	2200K	1200 Lm/M	120 Lm/W	29,95€
			84810	2700K	1300 Lm/M	130 Lm/W	29,95€
			84811	3000K	1400 Lm/M	140 Lm/W	29,95€
			84812	4000K	1450 Lm/M	145 Lm/W	29,95€
			84813	6000K	1500 Lm/M	150 Lm/W	29,95€

Voltage	CRI	SDMC
48V	>80	≤3

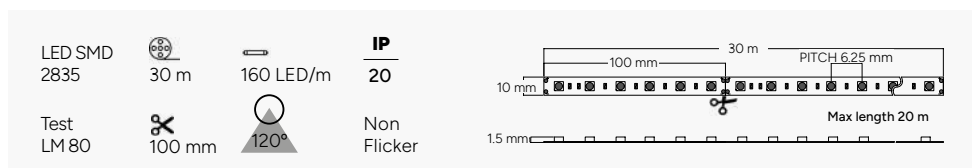

Importante instalar disipador de calor / Important to install heat sink / Important d'installer le dissipateur de chaleur / Importante installare il dissipatore di calore

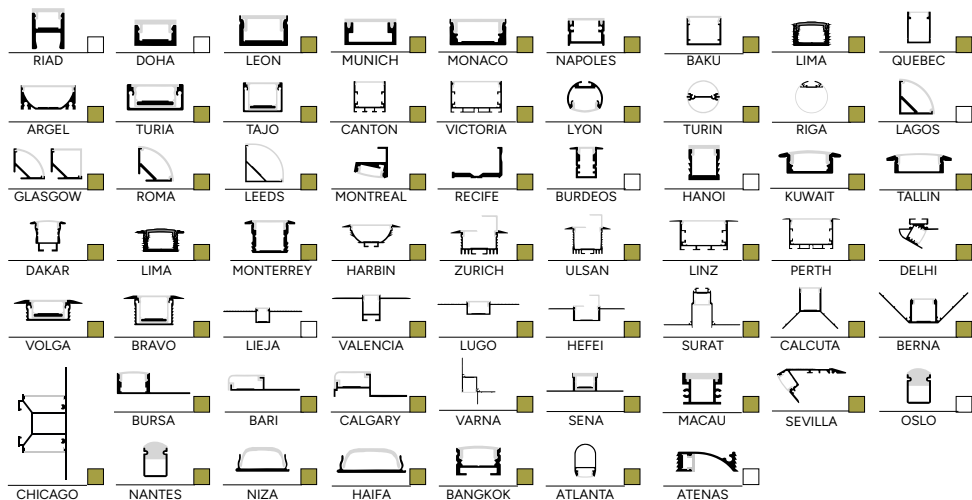

outdoor series

ES_ Tecnología LED lineal flexible para iluminación de uso interior o exterior a nivel profesional con una elevada protección contra agentes externos y humedades, donde se presentan distintas opciones en potencias, temperaturas de color, reproducción cromática y siempre con altas prestaciones en eficiencia energética.

EN_ Flexible linear LED technology, for lighting for indoor or outdoor use at a professional level with high protection against external agents and humidities, where different options are presented in powers, color temperatures, color reproduction and always with high performance in energy efficiency.





FR_ Technologie LED linéaire flexible, pour un éclairage à usage intérieur ou extérieur de niveau professionnel avec une protection élevée contre les agents extérieurs et humidités, où différentes options sont présentées dans les puissances, les températures de couleur, la reproduction des couleurs et toujours avec des performances élevées en matière d'efficacité énergétique.

IT_ Tecnologia LED lineare flessibile per l'illuminazione professionale di interni ed esterni con un elevato grado di protezione dagli agenti esterni. Livello professionale con elevata protezione dagli agenti esterni e dall'umidità, con diverse opzioni di potenza, temperatura di colore, resa cromatica e sempre con un'elevata efficienza energetica, riproduzione cromatica e sempre con elevate prestazioni in termini di efficienza energetica.





Power 4.8 W/m Life Time 75.000 h PCB Thickness 3 oz

Voltage 24V CRI >80 SDMC ≤3

CODE	CCT (K)	LUMEN OUTPUT	Lm/W	PRICE
83996	 2700K	432 Lm/M	90 Lm/W	11,95€
83997	 3000K	437 Lm/M	91 Lm/W	11,95€
83998	 4000K	447 Lm/M	93 Lm/W	11,95€
83999	 6000K	456 Lm/M	95 Lm/W	11,95€

LED SMD 2835  20 m

Silicone  50 mm

120 LED/m 

 120°



IP 67

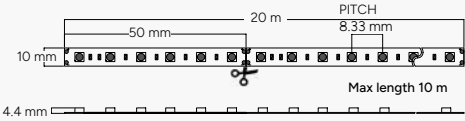



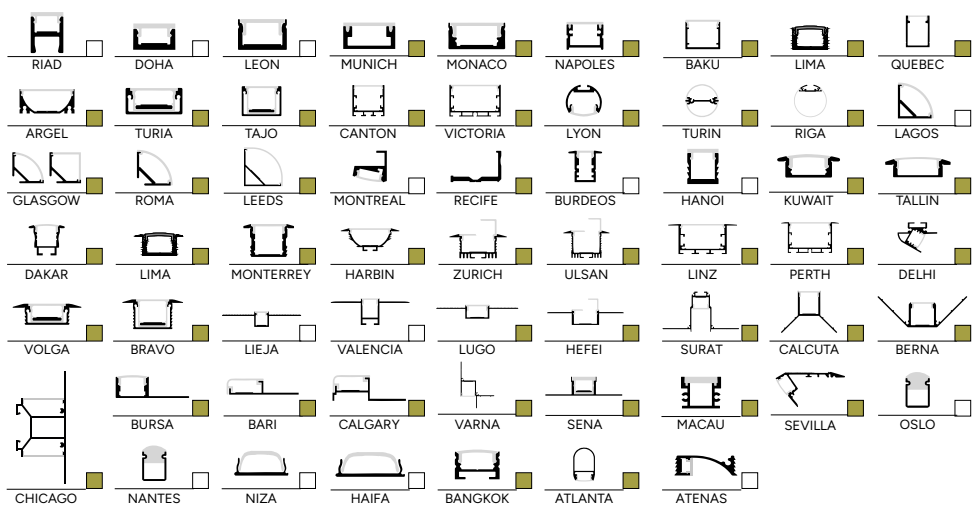



Non Flicker



Importante instalar disipador de calor / Important to install heat sink / Important d'installer le dissipateur de chaleur / Importante installare il dissipatore di calore



 Compatible / Compatibile  No compatible / Not compatible / Non compatibile / Non compatibile

Power	Life Time	PCB Thickness	CODE	CCT (K)	LUMEN OUTPUT	Lm/W	M	PRICE
9.6 W/m	75.000 h	3 oz	86003	 2700K	1258 Lm/M	131 Lm/W	1 m/L	13,95€
			84004	 3000K	1277 Lm/M	133 Lm/W	1 m/L	13,95€
Voltage	CRI	SDMC	84005	 4000K	1296 Lm/M	135 Lm/W	1 m/L	13,95€
24V	>80	≤3	84006	 6000K	1344 Lm/M	140 Lm/W	1 m/L	13,95€
			80526	 2700K	1258 Lm/M	131 Lm/W	5 m Roll	69,75€
			80527	 3000K	1277 Lm/M	133 Lm/W	5 m Roll	69,75€
			80528	 4000K	1296 Lm/M	135 Lm/W	5 m Roll	69,75€
			80529	 6000K	1344 Lm/M	140 Lm/W	5 m Roll	69,75€

LED SMD
2835

5-20 m

140 LED/m

Silicone

50 mm

120°

IP
67

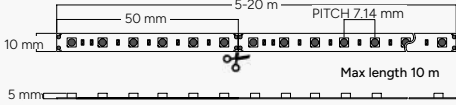

Non
Flicker

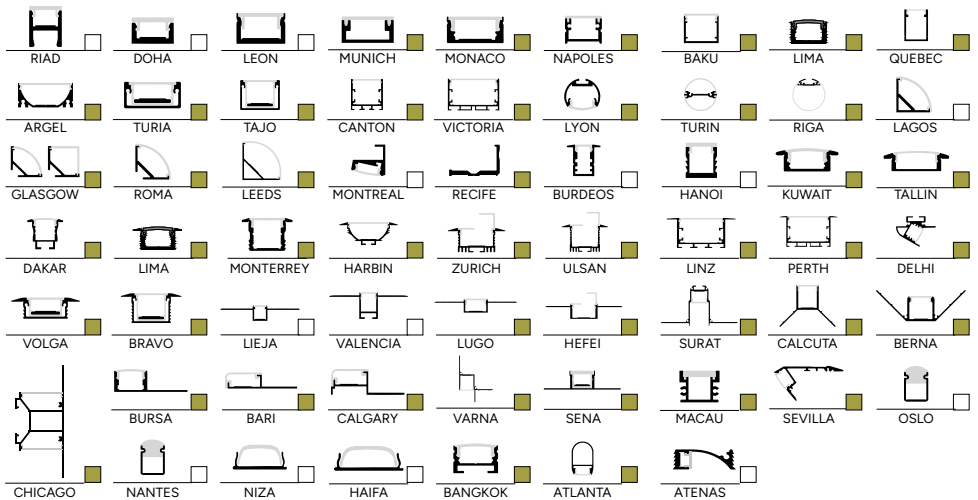

Importante instalar disipador de calor / Important to install heat sink / Important d'installer le dissipateur de chaleur / Importante installare il dissipatore di calore







*m/L: Lineal meter

 Compatible / Compatibile  No compatible / Not compatible / Non compatibile / Non compatibile

OREGÓN

12W/m · IP67 · 24V · CRI>80

Power	Life Time	PCB Thickness	CODE	CCT (K)	LUMEN OUTPUT	Lm/W	PRICE
12 W/m	75.000 h	3 oz	86034	 2700K	1560 Lm/M	130 Lm/W	14,95€
			80035	 3000K	1600 Lm/M	133 Lm/W	14,95€
Voltage	CRI	SDMC	80036	 4000K	1640 Lm/M	136 Lm/W	14,95€
24V	>80	≤3	80037	 6000K	1680 Lm/M	140 Lm/W	14,95€

LED SMD 2835  20 m

Silicone  62.5 mm

112 LED/m 

 120°

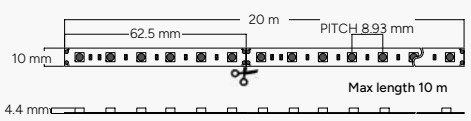

IP 67

Non Flicker



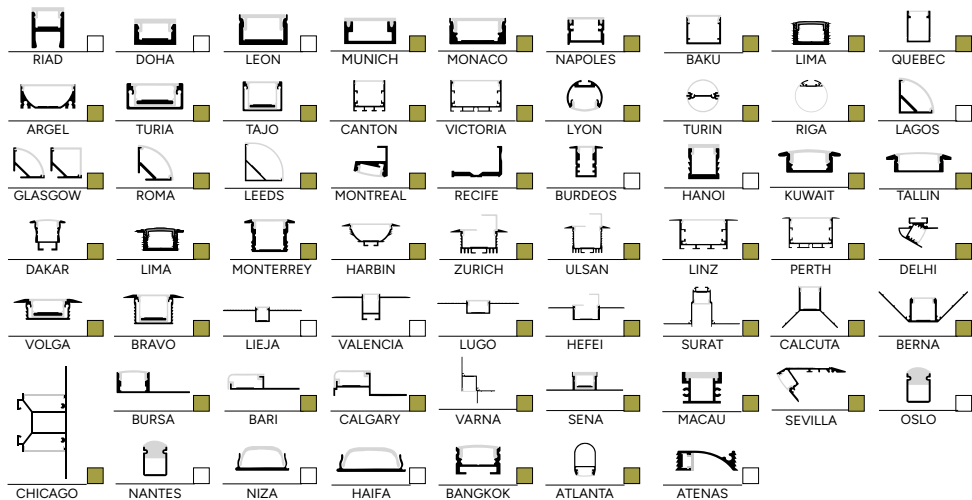



Importante instalar disipador de calor / Important to install heat sink / Important d'installer le dissipateur de chaleur / Importante installare il dissipatore di calore



 Compatible / Compatibile  No compatible / Not compatible / Non compatible / Non compatibile

CALIFORNIA



12W/m · IP67 · 24V · CRI>90

Power	Life Time	PCB Thickness	CODE	CCT (K)	LUMEN OUTPUT	Lm/W	PRICE
12 W/m	75.000 h	3 oz	84088	 2700K	1050 Lm/M	88 Lm/W	17,95€
			84089	 3000K	1120 Lm/M	93 Lm/W	17,95€
Voltage	CRI	SDMC	84090	 4000K	1200 Lm/M	100 Lm/W	17,95€
24V	>90	≤3	84091	 6000K	1280 Lm/M	106 Lm/W	17,95€

LED COB	 20 m	 480 LED/m	IP 67	 <p>50 mm 20 m</p> <p>12.5 mm</p> <p>Max length 10m</p> <p>5 mm</p>
Silicone	 50 mm	 120°	Non Flicker	

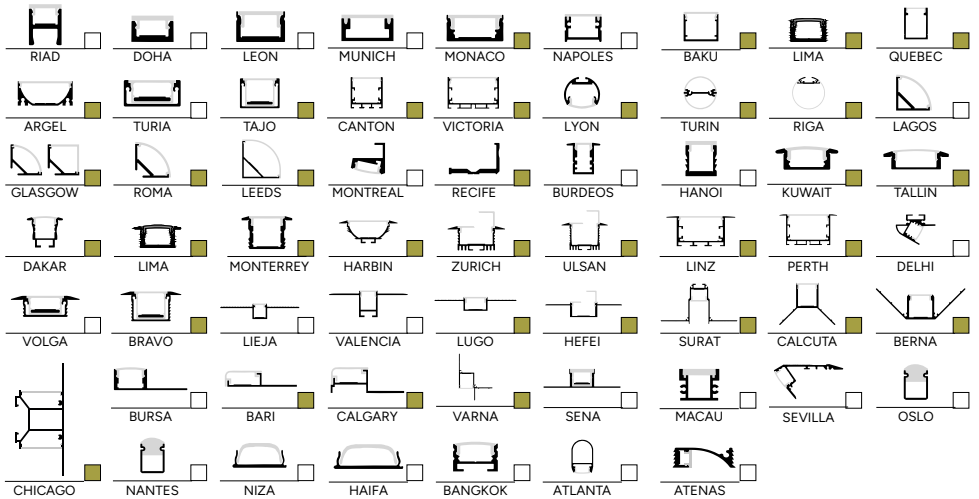







Importante instalar disipador de calor / Important to install heat sink / Important d'installer le dissipateur de chaleur / Importante installare il dissipatore di calore







 Compatible / Compatibile  No compatible / Not compatible / Non compatibile / Non compatibile

Power Life Time PCB Thickness
14.4 W/m 75.000 h 3 oz

Voltage CRI SDMC
24V >80 ≤3

CODE	CCT (K)	LUMEN OUTPUT	Lm/W	M	PRICE
84951	 2700K	1325 Lm/M	92 Lm/W	1 m/L	10,95€
84952	 3000K	1354 Lm/M	94 Lm/W	1 m/L	10,95€
84953	 4000K	1397 Lm/M	97 Lm/W	1 m/L	10,95€
84954	 6000K	1440 Lm/M	100 Lm/W	1 m/L	10,95€
84956	 2700K	1325 Lm/M	92 Lm/W	5 m Roll	54,75€
84957	 3000K	1354 Lm/M	94 Lm/W	5 m Roll	54,75€
84958	 4000K	1397 Lm/M	97 Lm/W	5 m Roll	54,75€
84959	 6000K	1440 Lm/M	100 Lm/W	5 m Roll	54,75€

LED SMD 2835  5-20 m  120 LED/m

Silicone  50 mm  120°

IP
65

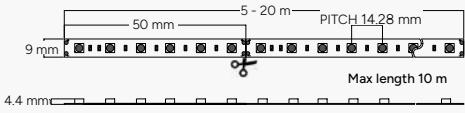

Non Flicker

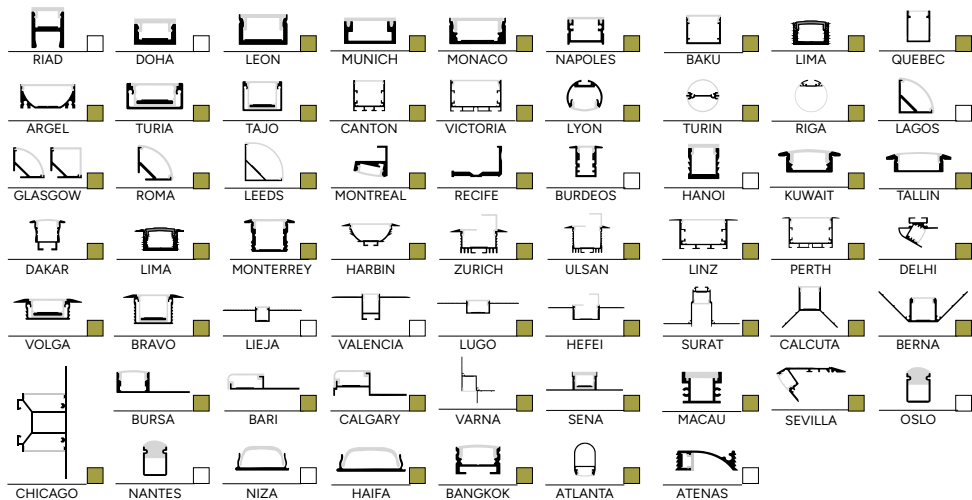

Importante instalar disipador de calor / Important to install heat sink / Important d'installer le dissipateur de chaleur / Importante installare il dissipatore di calore



*m/L: Lineal meter

 Compatible / Compatibile  No compatible / Not compatible / Non compatible / Non compatibile

ORLANDO



NEW PRODUCT

14.4W/m · IP67 · 24V · CRI>80

Power 14.4 W/m
Life Time 75.000 h
PCB Thickness 3 oz

Voltage 24V
CRI >80
SDMC ≤3

CODE	CCT (K)	LUMEN OUTPUT	Lm/W	PRICE
86009	2200K	1857 Lm/M	129 Lm/W	17,95€
86010	2700K	1886 Lm/M	131 Lm/W	17,95€
84011	3000K	1915 Lm/M	133 Lm/W	17,95€
84012	4000K	1959 Lm/M	135 Lm/W	17,95€
84013	6000K	2016 Lm/M	140 Lm/W	17,95€
84975	Red	495 Lm/M	35 Lm/W	19,95€
84976	Blue	375 Lm/M	26 Lm/W	17,95€
84977	Green	1990 Lm/M	138 Lm/W	19,95€
84978	Yellow	1890 Lm/M	131 Lm/W	21,95€
84979	Pink	1150 Lm/M	80 Lm/W	21,95€

LED SMD 2835
20 m
210 LED/m
Silicone
33.3 mm

IP 67
Non Flicker
120°



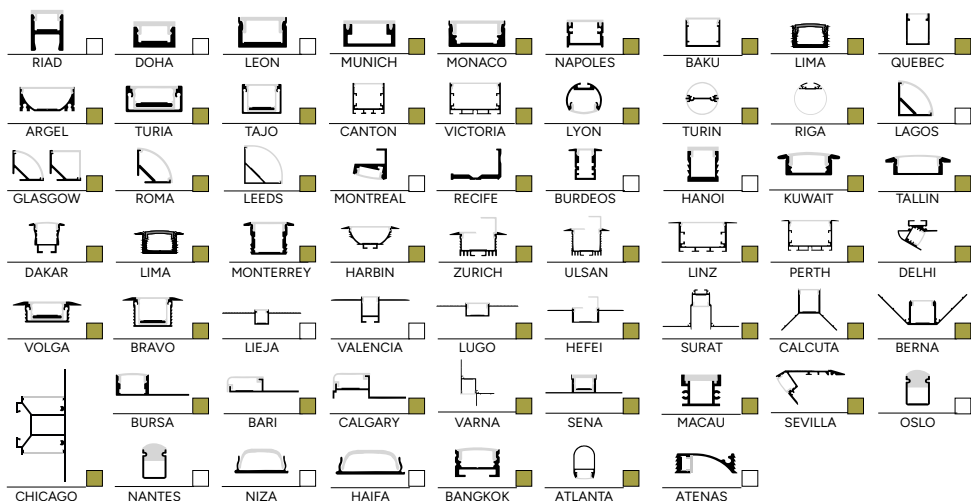

Importante instalar disipador de calor / Important to install heat sink / Important d'installer le dissipateur de chaleur / Importante installare il dissipatore di calore



Compatible / Compatibile No compatible / Not compatible / Non compatible / Non compatibile

DENVER

19.2W/m · IP67 · 24V · CRI>80

Power	Life Time	PCB Thickness	CODE	CCT (K)	LUMEN OUTPUT	Lm/W	PRICE
19.2 W/m	75.000 h	3 oz	86017	 2700K	2515 Lm/M	131 Lm/W	22,95€
			84018	 3000K	2553 Lm/M	133 Lm/W	22,95€
Voltage	CRI	SDMC	84019	 4000K	2592 Lm/M	135 Lm/W	22,95€
24V	>80	≤3	84020	 6000K	2688 Lm/M	140 Lm/W	22,95€

LED SMD
2835

 20 m

 238 LED/m

Silicone

 29.4 mm

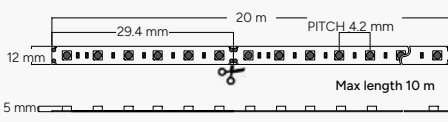

IP
67

Non
Flicker



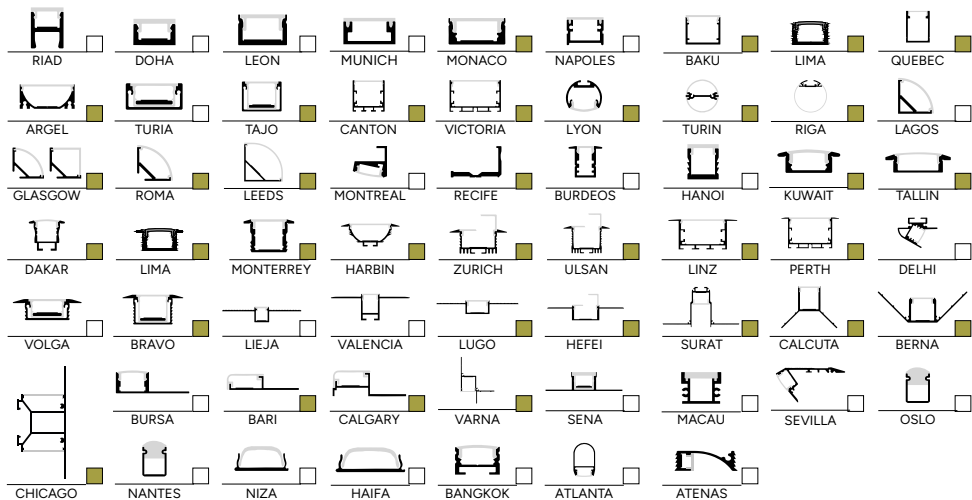



Importante instalar disipador de calor / Important to install heat sink / Important d'installer le dissipateur de chaleur / Importante installare il dissipatore di calore





 Compatible / Compatibile  No compatible / Not compatible / Non compatible / Non compatibile

DETROIT

24W/m · IP67 · 24V · CRI>80

Power	Life Time	PCB Thickness	CODE	CCT (K)	LUMEN OUTPUT	Lm/W	PRICE
24 W/m	75.000 h	3 oz	86024	 2700K	2640 Lm/M	110 Lm/W	23,95€
			84025	 3000K	2688 Lm/M	112 Lm/W	23,95€
Voltage	CRI	SDMC	84026	 4000K	2760 Lm/M	115 Lm/W	23,95€
24V	>80	≤3	84027	 6000K	2880 Lm/M	120 Lm/W	23,95€

LED SMD 2835  20 m

 Silicone  25 mm

240 LED/m  120°

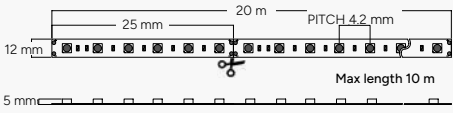

IP
67

Non Flicker

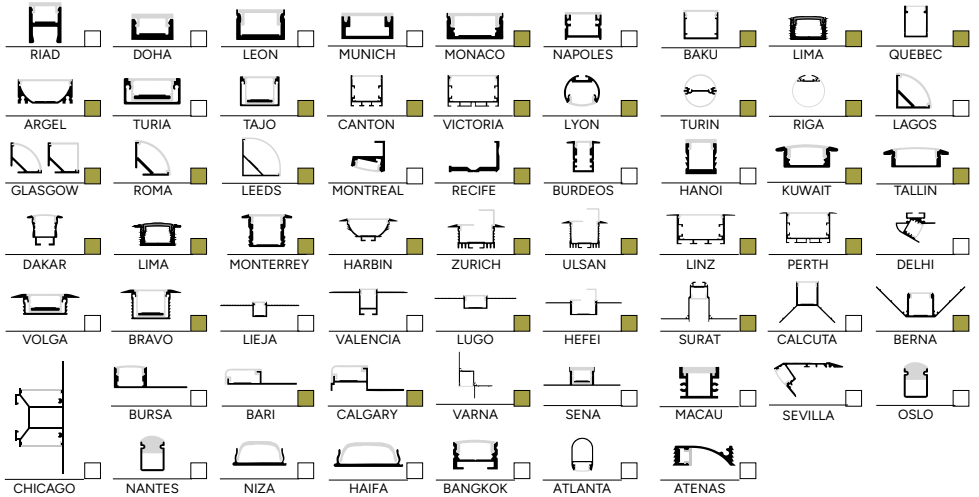

Importante instalar disipador de calor / Important to install heat sink / Important d'installer le dissipateur de chaleur / Importante installare il dissipatore di calore



 Compatible / Compatibile  No compatible / Not compatible / Non compatibile / Non compatibile

MADISON



RGB

12W/m · IP67 · 24V · CRI>90

Power 12 W/m Life Time 75.000 h PCB Thickness 3 oz

CODE	CCT (K)	LUMEN OUTPUT	Lm/W	PRICE
86051	RGB	495 Lm/M	41 Lm/W	25,95€

Voltage 24V SDMC ≤3

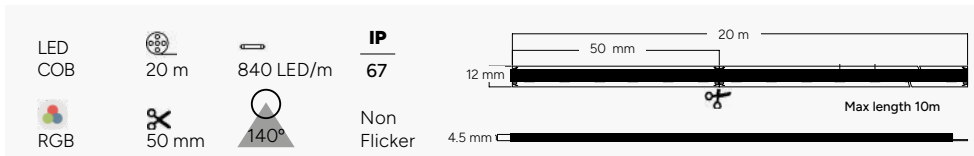

Importante instalar disipador de calor / Important to install heat sink / Important d'installer le dissipateur de chaleur / Importante installare il dissipatore di calore

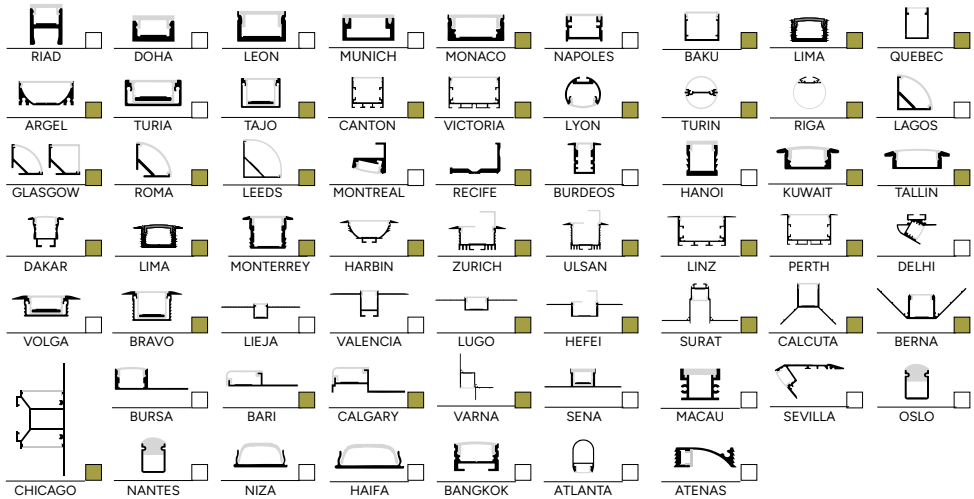

Compatible / Compatibile No compatible / Not compatible / Non compatible / Non compatibile

ALASKA



RGB

14.4W/m · IP65 · 24V · CRI>80

Power 14.4 W/m Life Time 75.000 h PCB Thickness 3 oz

CODE	CCT (K)	LUMEN OUTPUT	M	PRICE
84962	RGB	540 Lm/M	1 m/L	14,95€
84963	RGB	540 Lm/M	5 m Roll	69,95€

Voltage 24V SDMC ≤ 3

LED SMD 5050 RGB

5-30 m

120 LED/m

100 mm

120°

IP 65

Non Flicker

Importante instalar disipador de calor / Important to install heat sink / Important d'installer le dissipateur de chaleur / Importante installare il dissipatore di calore

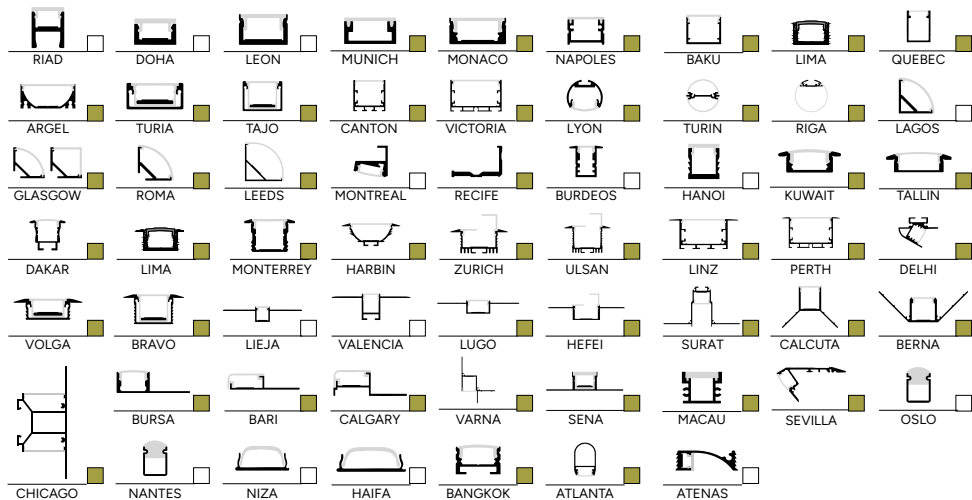







*m/L: Lineal meter

■ Compatible / Compatibile □ No compatible / Not compatible / Non compatible / Non compatibile

Power 15 W/m Life Time 75.000 h PCB Thickness 3 oz

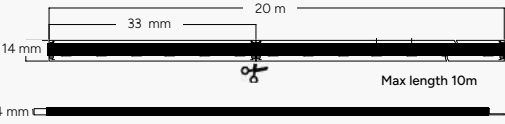

Voltage 24V SDMC
≤3

CODE	CCT (K)	LUMEN OUTPUT	PRICE
86054	 3000K	645 Lm/M	28,95€
86055	 4000K	675 Lm/M	28,95€

LED COB	 20 m	 840 LED/m	IP 67	 <p>14 mm 33 mm 20 m Max length 10m</p> <p>4.4 mm</p>
RGB+W	 33 mm	 120°	Non Flicker	

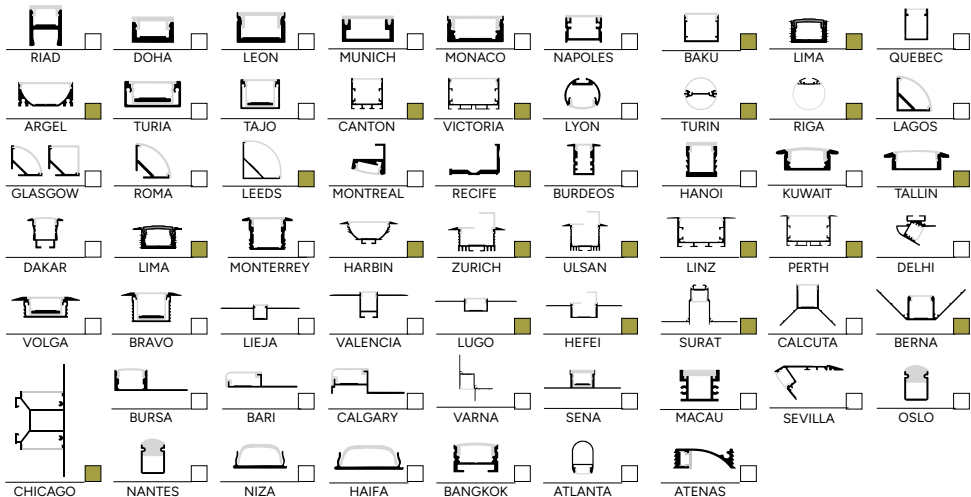
Importante instalar disipador de calor / Important to install heat sink / Important d'installer le dissipateur de chaleur / Importante installare il dissipatore di calore



 Compatible / Compatibile  No compatible / Not compatible / Non compatibile / Non compatibile

TORONTO



RGB+CCT

26.4W/m · IP67 · 24V · CRI>90

Power 26.4 W/m Life Time 75.000 h PCB Thickness 3 oz

Voltage 24V SDMC ≤3

CODE	CCT (K)	LUMEN OUTPUT	PRICE
	RGB+CCT	600 Lm/M	
84048	3000K	480 Lm/M	30,95€
	6000K	600 Lm/M	

LED SMD 5050+2016 RGB DUAL

20 m

180 LED/m

100 mm

IP 67

Non Flicker

Importante instalar disipador de calor / Important to install heat sink / Important d'installer le dissipateur de chaleur / Importante installare il dissipatore di calore

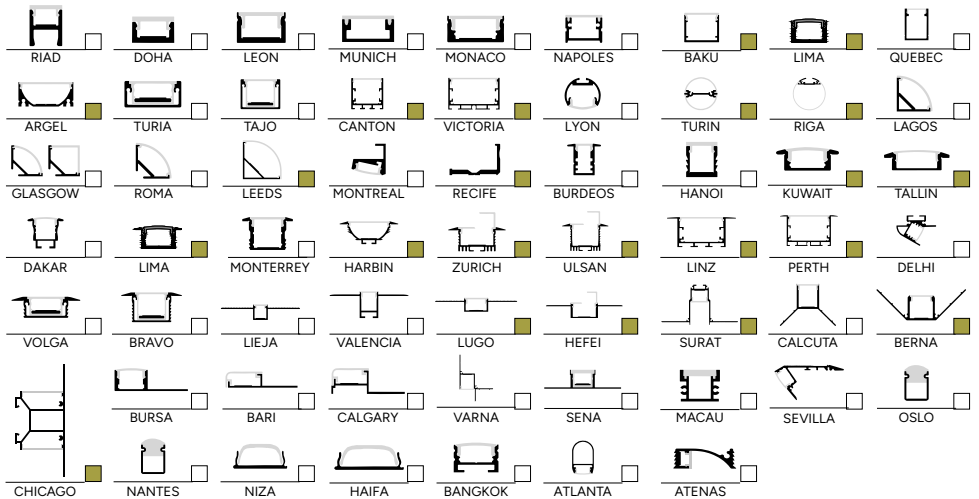

Compatible / Compatibile No compatible / Not compatible / Non compatible / Non compatibile



GEORGIA



TUNEABLE WHITE

19.2W/m · IP67 · 24V · CRI>90

Power 19.2 W/m
Life Time 75.000 h
PCB Thickness 3 oz

CODE	CCT (K)	LUMEN OUTPUT	PRICE
84043	○+● 1800-6500K Dimmable	2160 Lm/M	24,95€

Voltage 24V
CRI >90
SDMC ≤3

LED SMD 2016
20 m
TUNEABLE WHITE
50 mm

240 LED/m
120°
Non Flicker

IP 67
Max length 10 m

Importante instalar disipador de calor / Important to install heat sink / Important d'installer le dissipateur de chaleur / Importante installare il dissipatore di calore

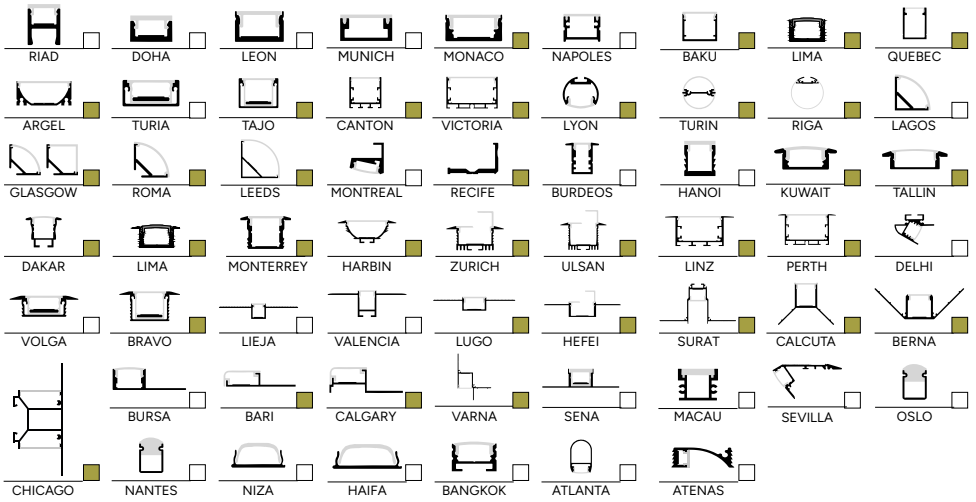

Compatible / Compatibile No compatible / Not compatible / Non compatibile

food series

ES_ Tecnología LED lineal flexible para la iluminación de productos de alimentación, con una alta reproducción cromática que garantiza la mejor visibilidad, siempre con altas prestaciones en eficiencia energética.

EN_ Flexible linear LED technology, for lighting food products, with high color rendering to give the best lighting to the products to be illuminated, always with high performance in energy efficiency.

FR_ Technologie LED linéaire flexible, pour l'éclairage des produits alimentaires, avec un rendu des couleurs élevé pour donner le meilleur éclairage aux produits à éclairer, toujours avec des performances élevées en matière d'efficacité énergétique.

IT_ Tecnologia LED lineare flessibile per l'illuminazione di prodotti alimentari, con un'alta riproduzione cromatica che garantisce la migliore illuminazione, sempre con alte prestazioni in termini di efficienza energetica.















CORTADO MEXICANO
LA PAQUITA DE
01
UNIDADES
4.5



DAKOTA

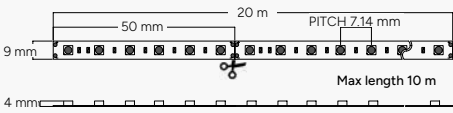

14.4W/m · IP67 · 24V · CRI>80

Power	Life Time	PCB Thickness	CODE	CCT (K)	LUMEN OUTPUT	Lm/W	PRICE
14.4 W/m	75.000 h	3 oz	84035	 2900-3200K	1120 Lm/M	78 Lm/W	19,95€
			84036	 2200-2400K	980 Lm/M	68 Lm/W	19,95€
			84037	 2600-2900K	980 Lm/M	68 Lm/W	19,95€
			84038	 3700-4250K	1120 Lm/M	78 Lm/W	19,95€
			84039	 3200-3850K	980 Lm/M	68 Lm/W	19,95€
			84040	 1800-2000K	700 Lm/M	49 Lm/W	19,95€

LED SMD 2835	 20 m	 140 LED/m	IP 67	
Test LM 80	 50 mm	 120°	Non Flicker	

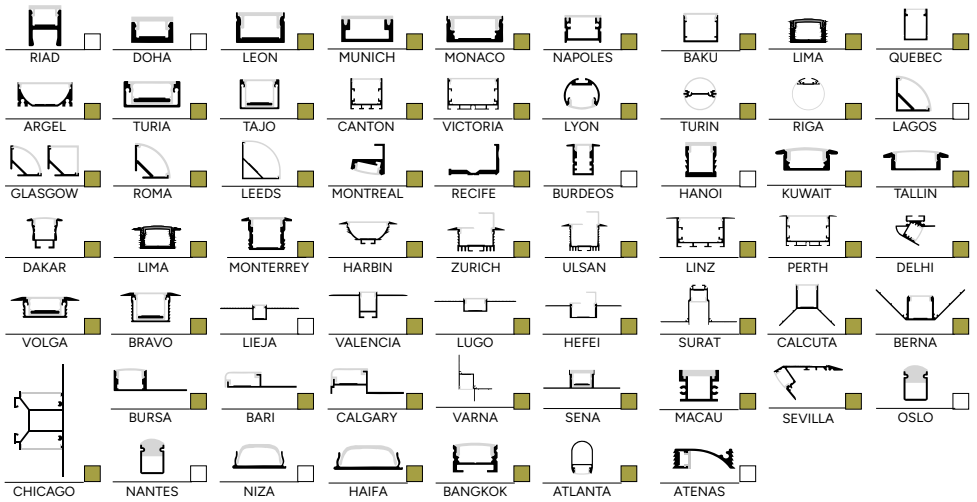
Importante instalar disipador de calor / Important to install heat sink / Important d'installer le dissipateur de chaleur / Importante installare il dissipatore di calore



 Compatible / Compatibile  No compatible / Not compatible / Non compatibile



48V

VANCOUVER



Max 20 m
continuous line

10W/m · IP67 · 48V · CRI>80

Power	Life Time	PCB Thickness	CODE	CCT (K)	LUMEN OUTPUT	Lm/W	PRICE
10 W/m	75.000 h	3 oz	84815	2700K	1300 Lm/M	130 Lm/W	36,95€
			84816	3000K	1400 Lm/M	140 Lm/W	36,95€
Voltage	CRI	SDMC	84817	4000K	1450 Lm/M	145 Lm/W	36,95€
48V	>80	≤3	84818	6000K	1500 Lm/M	150 Lm/W	36,95€

LED SMD 2835 30 m 160 LED/m **IP 67**

Silicone 100 mm 120°

Non Flicker

Importante instalar disipador de calor / Important to install heat sink / Important d'installer le dissipateur de chaleur / Importante installare il dissipatore di calore

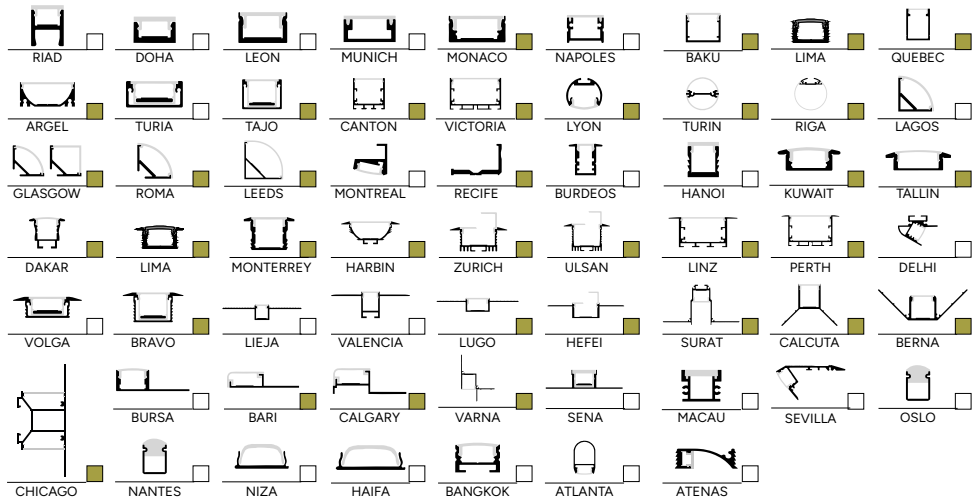

Compatible / Compatibile No compatible / Not compatible / Non compatible / Non compatibile

high voltage

ES_ Iluminación sin límites con las tiras LED a 230V, la solución ideal para proyectos que requieren tiradas largas y fácil instalación, ofreciendo una iluminación uniforme y eficiente, perfecta para exteriores e interiores. Descubre un mayor alcance con instalaciones de hasta 50 metros y alta eficiencia con un consumo reducido, además de una resistencia y versatilidad superiores.

EN_ Unlimited illumination with 230V high voltage LED strips, the ideal solution for projects requiring high power, long lengths and easy installation, offering uniform and efficient illumination, perfect for outdoors and indoors. Discover greater reach with installations up to 50 metres and high efficiency with reduced power consumption, plus superior robustness and versatility, suitable for any environment with outdoor weatherproof options.

FR_ Illumination illimitée avec les bandes LED haute tension 230V, la solution idéale pour les projets nécessitant une puissance élevée, de grandes longueurs et une installation facile, offrant une illumination uniforme et efficace, parfaite pour l'extérieur et l'intérieur. Découvrez une plus grande portée avec des installations jusqu'à 50 mètres et une efficacité élevée avec une consommation d'énergie réduite, ainsi qu'une robustesse et une polyvalence supérieures, adaptées à tous les environnements avec des options de résistance aux intempéries en extérieur.

IT_ Illuminazione illimitata con le strisce LED ad alta tensione da 230 V, la soluzione ideale per i progetti che richiedono alta potenza, lunghezze elevate e facilità di installazione, che offrono un'illuminazione uniforme ed efficiente, perfetta per esterni e interni. Scoprite una maggiore portata con installazioni fino a 50 metri e un'elevata efficienza con un consumo energetico ridotto, oltre a una robustezza e una versatilità superiori, adatte a qualsiasi ambiente grazie alle opzioni di resistenza alle intemperie esterne.



TUCSON



10W/m · IP65 · 230V · CRI>80

Power 10 W/m
Life Time 75.000 h
PCB Thickness 3 oz

Voltage 230V
CRI >80
SDMC ≤3

CODE	CCT (K)	LUMEN OUTPUT	Lm/W	PRICE
84084	2700K	970 Lm/M	97 Lm/W	16,95€
84085	3000K	990 Lm/M	99 Lm/W	16,95€
84086	4000K	1010 Lm/M	101 Lm/W	16,95€
84087	6000K	1030 Lm/M	103 Lm/W	16,95€

Connection Kit	PRICE
80054	7,95€



LED SMD 2835 50 m 120 LED/m IP 65

Test LM 80 100 mm 120°

Importante instalar disipador de calor / Important to install heat sink / Important d'installer le dissipateur de chaleur / Importante installare il dissipatore di calore

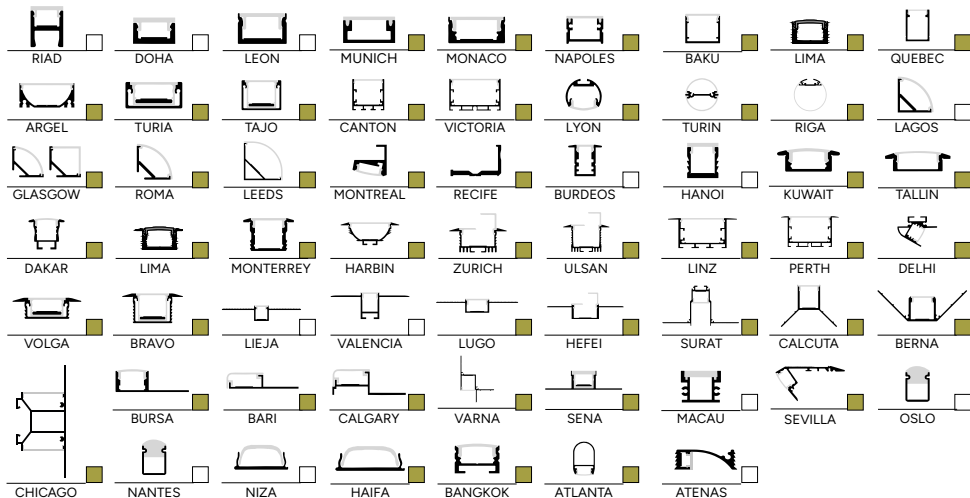

Compatible / Compatibile No compatible / Not compatible / Non compatible / Non compatibile

NELSON



14W/m · IP67 · 230V · CRI>85

			CODE	CCT (K)	LUMEN OUTPUT	Lm/W	PRICE
Power	Life Time	PCB Thickness	83890	2200K	1232 Lm/M	88 Lm/W	20,95€
14 W/m	75.000 h	3 oz	83891	2700K	1260 Lm/M	90 Lm/W	20,95€
			83892	3000K	1288 Lm/M	92 Lm/W	20,95€
Voltage	CRI	SDMC	83893	4000K	1316 Lm/M	94 Lm/W	20,95€
230V	>85	≤3	83894	6000K	1344 Lm/M	96 Lm/W	20,95€

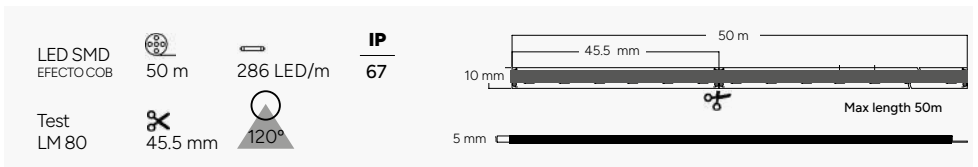

Importante instalar disipador de calor / Important to install heat sink / Important d'installer le dissipateur de chaleur / Importante installare il dissipatore di calore

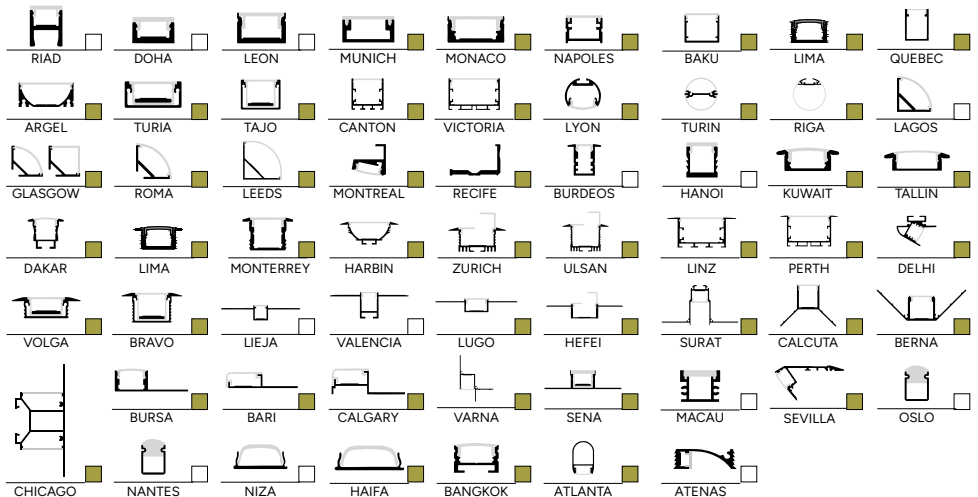
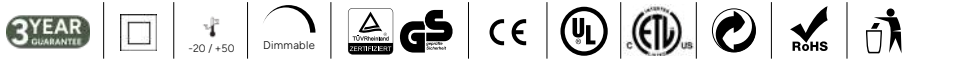

Compatible / Compatibile No compatible / Not compatible / Non compatible / Non compatibile

TEXAS



14W/m · IP65 · 230V · CRI>80

Power 14 W/m
Life Time 75.000 h
PCB Thickness 3 oz

Voltage 230V
CRI >80
SDMC ≤3

CODE	CCT (K)	LUMEN OUTPUT	Lm/W	PRICE
80018	2200K	1350 Lm/M	96 Lm/W	19,95€
80019	2700K	1358 Lm/M	97 Lm/W	19,95€
80020	3000K	1386 Lm/M	99 Lm/W	19,95€
80021	4000K	1414 Lm/M	101 Lm/W	19,95€
80022	6000K	1442 Lm/M	103 Lm/W	19,95€

Connection Kit	PRICE
80054	7,95€



LED SMD 2835 50 m 120 LED/m IP 65

Test LM80 100 mm 120°

Importante instalar disipador de calor / Important to install heat sink / Important d'installer le dissipateur de chaleur / Importante installare il dissipatore di calore

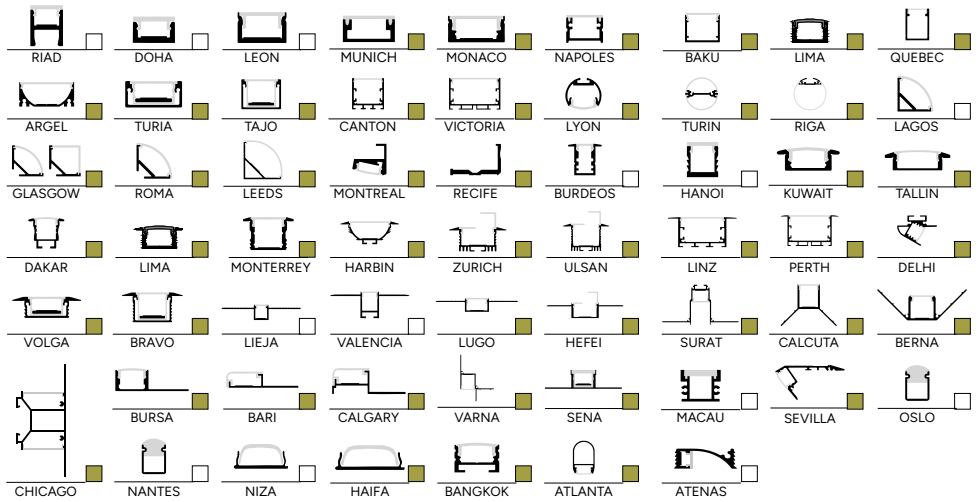

Compatible / Compatibile No compatible / Not compatible / Non compatible / Non compatibile

TEXAS



INDIVIDUAL COLOUR 14W/m · IP65 · 230V · CRI>80

Power 14 W/m
Life Time 75.000 h
PCB Thickness 3 oz

Voltage 230V
CRI >80
SDMC ≤3

CODE	CCT (K)	LUMEN OUTPUT	Lm/W	PRICE
84120	Red	343 Lm/M	25 Lm/W	26,95€
84121	Blue	252 Lm/M	18 Lm/W	26,95€
84122	Green	1820 Lm/M	130 Lm/W	26,95€
84123	Yellow	1442 Lm/M	103 Lm/W	26,95€
84124	Pink	861 Lm/M	62 Lm/W	26,95€

Connection Kit	PRICE
80054	7,95€



LED SMD 2835 50 m 120 LED/m IP 65

Test LM80 100 mm 120°

Importante instalar disipador de calor / Important to install heat sink / Important d'installer le dissipateur de chaleur / Importante installare il dissipatore di calore

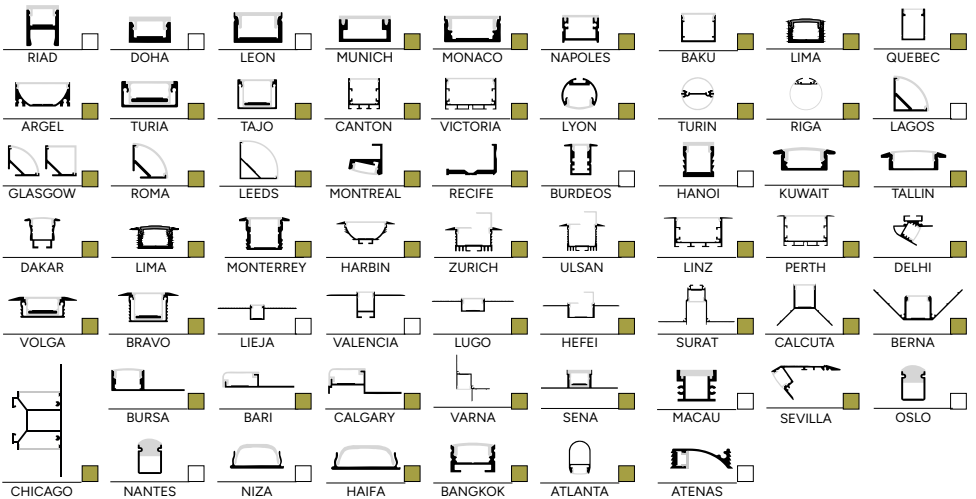

■ Compatible / Compatibile □ No compatible / Not compatible / Non compatible / Non compatibile

DALLAS



15W/m · IP67 · 230V · CRI>80

Power	Life Time	PCB Thickness	CODE	CCT (K)	LUMEN OUTPUT	Lm/W	PRICE
15 W/m	75.000 h	3 oz	83880	2700K	1500 Lm/M	97 Lm/W	21,95€
			83881	3000K	1600 Lm/M	99 Lm/W	21,95€
Voltage	CRI	SDMC	83882	4000K	1650 Lm/M	101 Lm/W	21,95€
230V	>80	≤3	83883	6000K	1650 Lm/M	103 Lm/W	21,95€

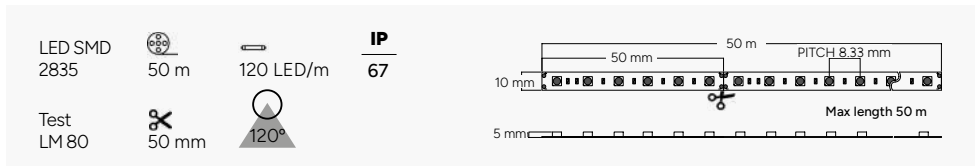

Importante instalar disipador de calor / Important to install heat sink / Important d'installer le dissipateur de chaleur / Importante installare il dissipatore di calore

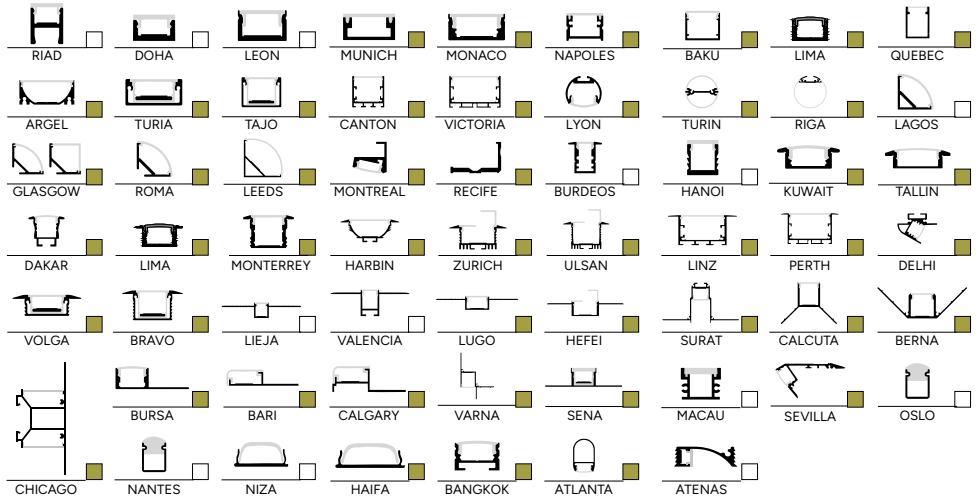

Compatible / Compatibile No compatible / Not compatible / Non compatible / Non compatibile

VEGAS



18W/m · IP65 · 230V · CRI>80

Power 18 W/m Life Time 75.000 h PCB Thickness 3 oz

Voltage 230V CRI >80 SDMC ≤3

CODE	CCT (K)	LUMEN OUTPUT	Lm/W	PRICE
80046	2700K	1746 Lm/M	97 Lm/W	21,95€
80047	3000K	1782 Lm/M	99 Lm/W	21,95€
80048	4000K	1818 Lm/M	101 Lm/W	21,95€
80049	6000K	1854 Lm/M	103 Lm/W	21,95€

Connection Kit	PRICE
80054	7,95€



LED SMD 2835 50 m 120 LED/m IP 65

Test LM 80 100 mm 120°

Importante instalar disipador de calor / Important to install heat sink / Important d'installer le dissipateur de chaleur / Importante installare il dissipatore di calore

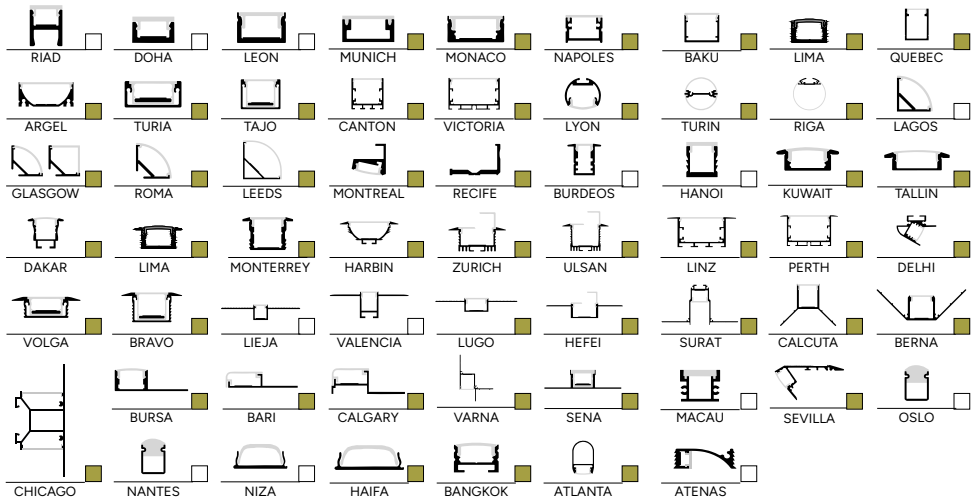

Compatible / Compatibile No compatible / Not compatible / Non compatible / Non compatibile

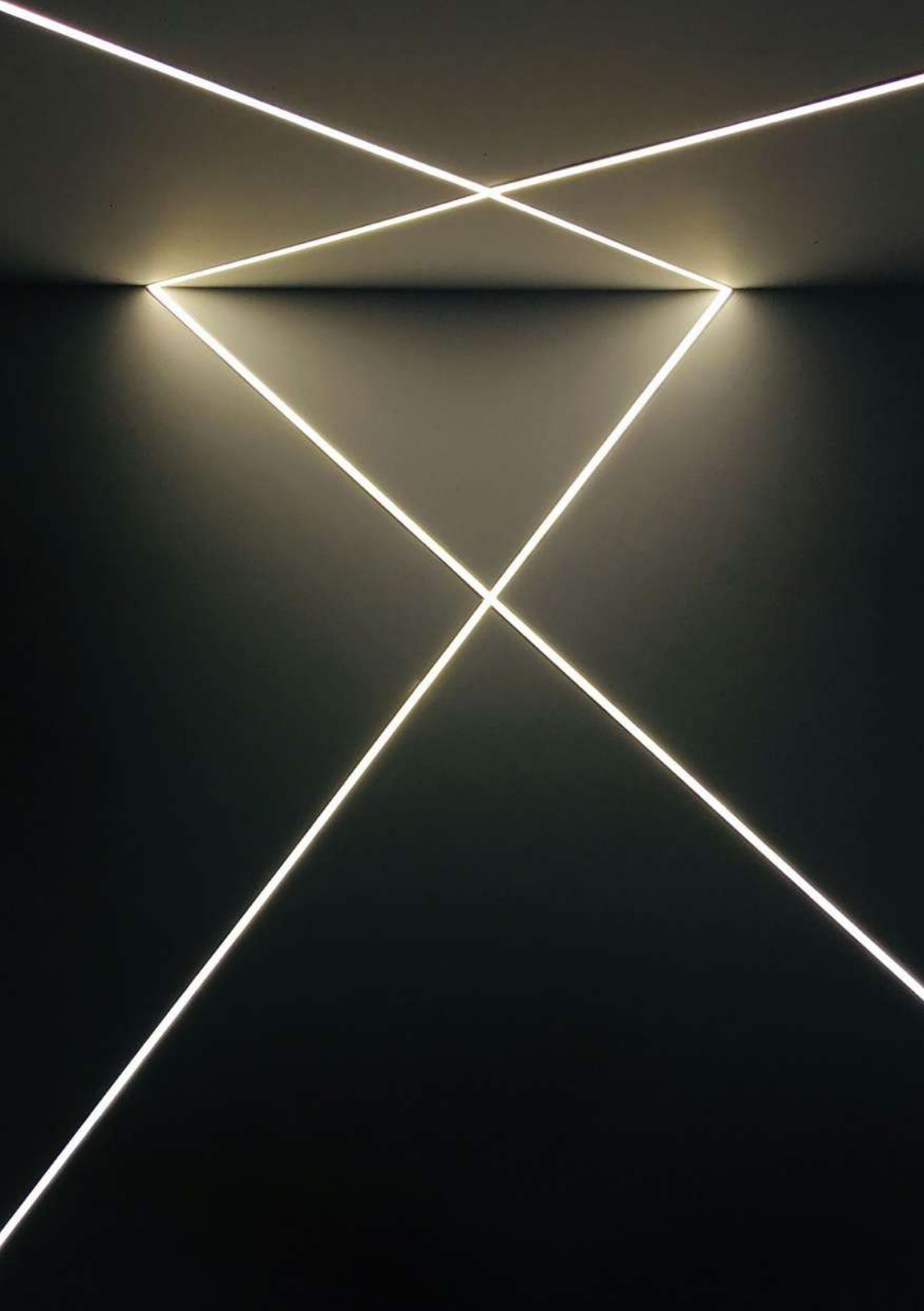

MEMPHIS



RGB

15W/m · IP65 · 230V · CRI>80

Power 15 W/m Life Time 75.000 h PCB Thickness 3 oz

CODE	CCT (K)	LUMEN OUTPUT	PRICE
80051	RGB	600 Lm/M	37,95€

Voltage 230V SDMC ≤3

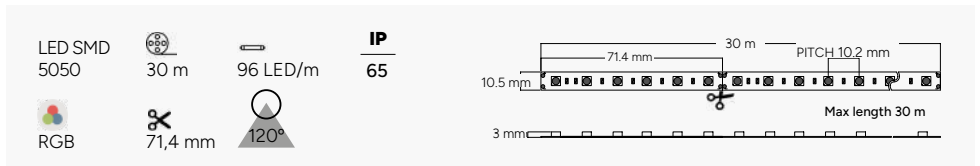

Importante instalar disipador de calor / Important to install heat sink / Important d'installer le dissipateur de chaleur / Importante installare il dissipatore di calore

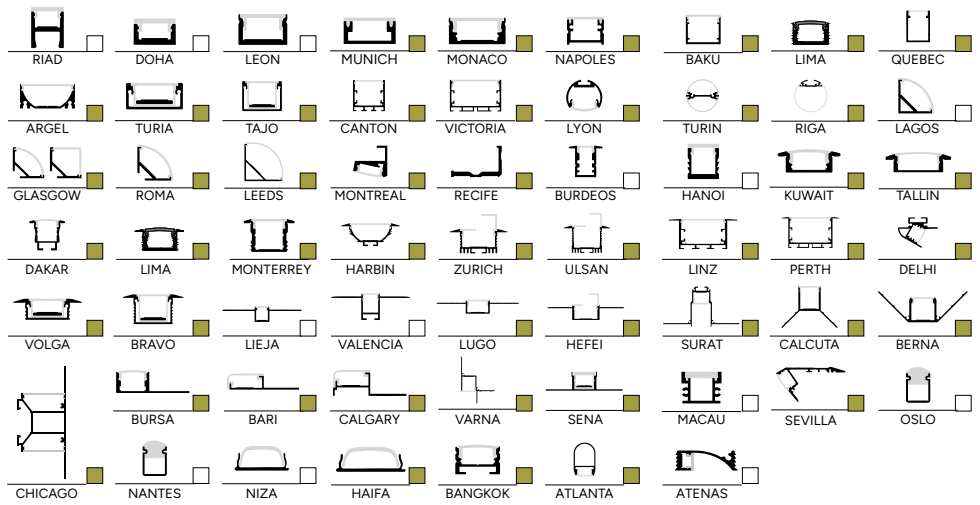
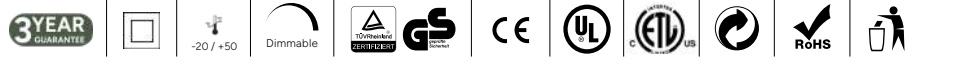

Compatible / Compatibile No compatible / Not compatible / Non compatible / Non compatibile

neon flex series

ES_ Diseñadas para transformar espacios con estilo, innovación y funcionalidad. Desde modelos finos como BORA y AURA, hasta soluciones robustas como MONTANA y JACKSON, además de la versátil ÓRBITA para formas personalizadas.

EN_ Designed to transform spaces with style, innovation and functionality. From slim models such as BORA and AURA, to robust solutions such as MONTANA and JACKSON, as well as the versatile ORBITA for customized shapes.

FR_ Conçus pour transformer les espaces avec style, innovation et fonctionnalité. Des modèles minces tels que BORA et AURA aux solutions robustes telles que MONTANA et JACKSON, en passant par le modèle polyvalent ORBITA pour les formes personnalisées.

IT_ Progettati per trasformare gli spazi con stile, innovazione e funzionalità. Dai modelli sottili come BORA e AURA, alle soluzioni robuste come MONTANA e JACKSON, fino alla versatile ORBITA per forme personalizzate.

An abstract graphic featuring two overlapping spheres. Each sphere is composed of numerous thin, concentric, swirling lines in a vibrant color palette of red, pink, purple, and blue. The lines create a sense of depth and movement, resembling a stylized rose or a complex, multi-layered structure. The background is a smooth gradient transitioning from light blue at the top to light green at the bottom.

Bring your ideas to life.

Power 8 W/m Life Time 75.000 h PCB Thickness 3 oz

Voltage 24V CRI >90 SDMC ≤3

CODE	CCT (K)	LUMEN OUTPUT	PRICE
84270	2700K	230 Lm/M	14,95€
84271	3000K	240 Lm/M	14,95€
84272	4000K	250 Lm/M	14,95€
84273	6000K	260 Lm/M	14,95€

LED SMD 2835	30 m	140 LED/m	IP 67	
Test LM 80	50 mm	120°	Non Flicker	

Importante instalar disipador de calor / Important to install heat sink / Important d'installer le dissipateur de chaleur / Importante installare il dissipatore di calore

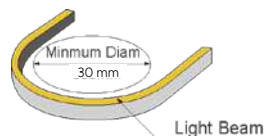
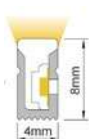
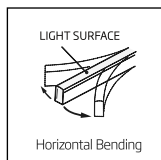

CODE	PRICE	DESCRIPTION
84284	13,95€	Perfil recto 2 m / Straight profile 2 m / Profilé droit 2 m
84282	1,15€	Clip de montaje / Mounting clip / Clip de montage / Clip di montaggio
84280	1,10€	Tapa inicial / Initial cover / Embout de fermeture initiale
84281	1,10€	Tapa final / End cap / Embout de fermeture finale



BORA

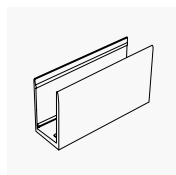

84284

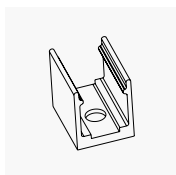

84282

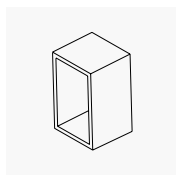

84281

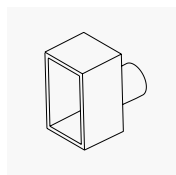

84280

Power 8 W/m
Life Time 75.000 h
PCB Thickness 3 oz

Voltage 24V
CRI >90
SDMC ≤3

CODE	CCT (K)	LUMEN OUTPUT	PRICE
84274	Red	120 Lm/M	14,95€
84275	Blue	120 Lm/M	14,95€
84276	Green	120 Lm/M	14,95€
84277	Yellow	120 Lm/M	14,95€
84278	Pink	120 Lm/M	14,95€

LED SMD 2835	30 m	140 LED/m	IP 67	
Test LM 80	50 mm	120°	Non Flicker	

Importante instalar disipador de calor / Important to install heat sink / Important d'installer le dissipateur de chaleur / Importante installare il dissipatore di calore

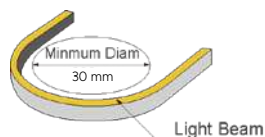
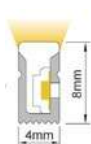
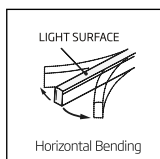

CODE	PRICE	DESCRIPTION
84284	13,95€	Perfil recto 2 m / Straight profile 2 m / Profilé droit 2 m
84282	1,15€	Clip de montaje / Mounting clip / Clip de montage / Clip di montaggio
84280	1,10€	Tapa inicial / Initial cover / Embout de fermeture initiale
84281	1,10€	Tapa final / End cap / Embout de fermeture finale



BORA

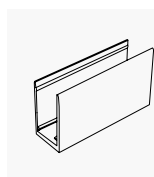

84284

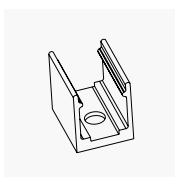

84282

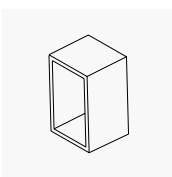



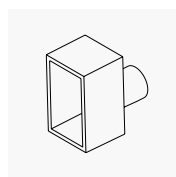

84281







84280

Power 8 W/m Life Time 75.000 h PCB Thickness 3 oz

Voltage 24V CRI >90 SDMC ≤3

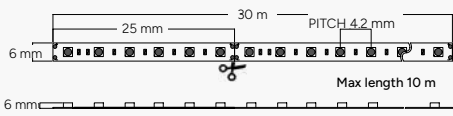
CODE	CCT (K)	LUMEN OUTPUT	PRICE
84390	 2700K	520 Lm/M	23,95€
84391	 3000K	560 Lm/M	23,95€
84392	 4000K	580 Lm/M	23,95€
84393	 6000K	600 Lm/M	23,95€

LED SMD 2219	 30 m	 240 LED/m	IP 67	
Test LM 80	 25 mm	 120°	Non Flicker	

Importante instalar disipador de calor / Important to install heat sink / Important d'installer le dissipateur de chaleur / Importante installare il dissipatore di calore

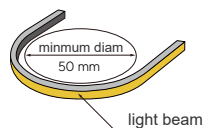
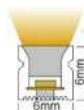
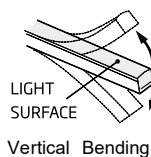

CODE	PRICE	DESCRIPTION
84404	13,95€	Perfil recto 2 m / Straight profile 2 m / Profilé droit 2 m
84402	1,15€	Clip de montaje / Mounting clip / Clip de montage / Clip di montaggio
84400	1,10€	Tapa inicial / Initial cover / Embout de fermeture initiale
84401	1,10€	Tapa final / End cap / Embout de fermeture finale



AURA

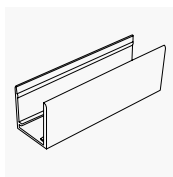

84404

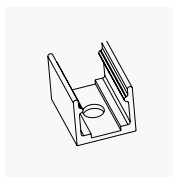

84402

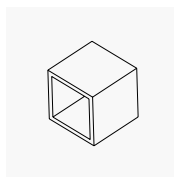

84401

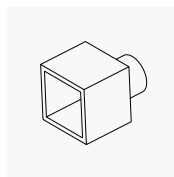

84400

Power 8 W/m
Life Time 75.000 h
PCB Thickness 3 oz

Voltage 24V
CRI >90
SDMC ≤3

CODE	CCT (K)	LUMEN OUTPUT	PRICE
84394	Red	240 Lm/M	23,95€
84395	Blue	240 Lm/M	23,95€
84396	Green	240 Lm/M	23,95€
84397	Yellow	240 Lm/M	23,95€
84398	Pink	240 Lm/M	23,95€

LED SMD 2219	30 m	240 LED/m	IP 67	
Test LM 80	25 mm	120°	Non Flicker	

Importante instalar disipador de calor / Important to install heat sink / Important d'installer le dissipateur de chaleur / Importante installare il dissipatore di calore

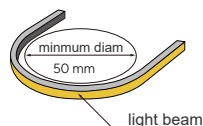
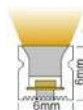
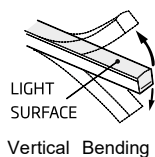

CODE	PRICE	DESCRIPTION
84404	13,95€	Perfil recto 2 m / Straight profile 2 m / Profilé droit 2 m
84402	1,15€	Clip de montaje / Mounting clip / Clip de montage / Clip di montaggio
84400	1,10€	Tapa inicial / Initial cover / Embout de fermeture initiale
84401	1,10€	Tapa final / End cap / Embout de fermeture finale



AURA

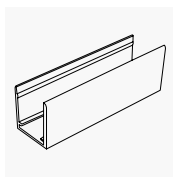

84404

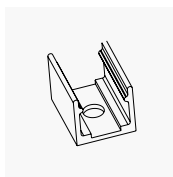

84402

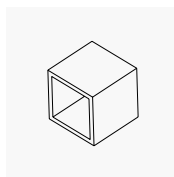

84401

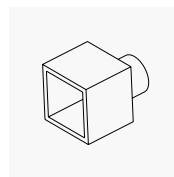





84400

MONTANA

12W/m · IP67 · 24V · CRI>90

Power 12 W/m Life Time 75.000 h PCB Thickness 3 oz

Voltage 24V CRI >90 SDMC ≤3

CODE	CCT (K)	LUMEN OUTPUT	PRICE
84370	 2700K	380 Lm/M	19,95€
84371	 3000K	400 Lm/M	19,95€
84372	 4000K	420 Lm/M	19,95€
84373	 6000K	430 Lm/M	19,95€

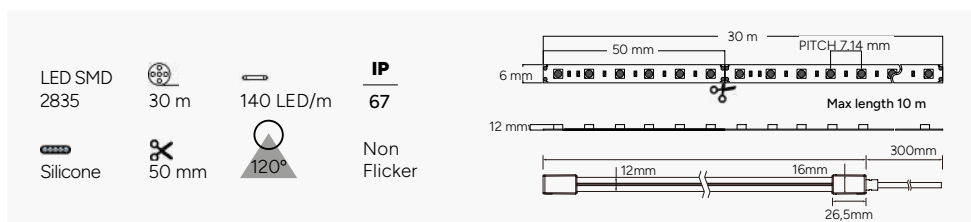

Importante instalar disipador de calor / Important to install heat sink / Important d'installer le dissipateur de chaleur / Importante installare il dissipatore di calore

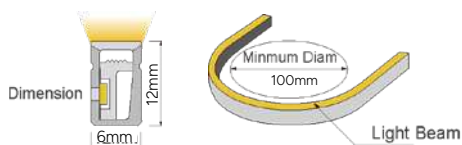
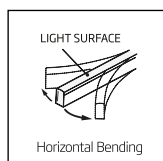

CODE	PRICE	DESCRIPTION
84156	13,95€	Perfil recto 2 m / Straight profile 2 m / Profilé droit 2 m
84147	1,25€	Clip de montaje / Mounting clip / Clip de montage / Clip di montaggio
84148	1,10€	Tapa final / End cap / Embout de fermeture finale
84149	1,10€	Tapa inicial / Initial cover / Embout de fermeture initiale
84150	1,15€	Tapa inicial lateral / Side initial cover / Embout de fermeture initiale latérale



MONTANA

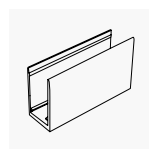

84156

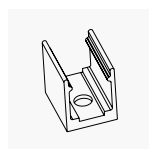

84147

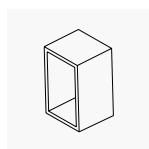

84148

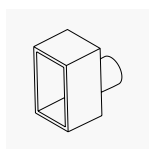

84149

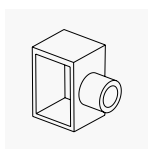

84150

MONTANA



RGB+W & INDIVIDUAL COLOR 12W/m · IP67 · 24V · CRI>90

Power 12 W/m Life Time 75.000 h PCB Thickness 3 oz

Voltage 24V SDMC ≤ 3

CODE	CCT (K)	LUMEN OUTPUT	LED/m	PRICE
84374	RGB	180 Lm/M	120 Lm/M	34,95€
84377	Red	100 Lm/M	140 Lm/M	21,95€
84378	Blue	75 Lm/M	140 Lm/M	21,95€
84379	Green	350 Lm/M	140 Lm/M	21,95€
84380	Yellow	320 Lm/M	140 Lm/M	21,95€
84381	Pink	190 Lm/M	140 Lm/M	21,95€

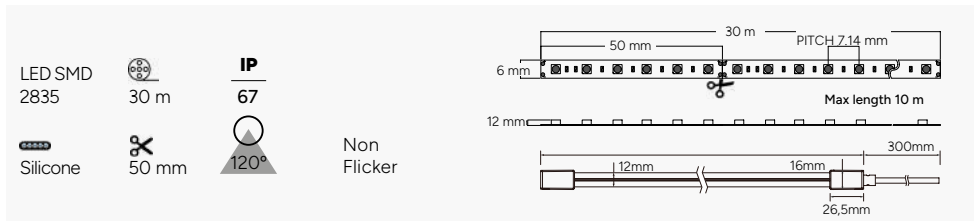

LED SMD 2835

IP 67

30 mm

Silicone

50 mm

120°

Non Flicker

Importante instalar disipador de calor / Important to install heat sink / Important d'installer le dissipateur de chaleur / Importante installare il dissipatore di calore

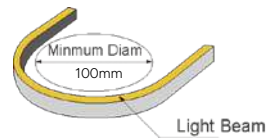
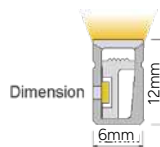
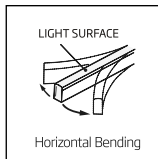

CODE	PRICE	DESCRIPTION
84156	13,95€	Perfil recto 2 m / Straight profile 2 m / Profilé droit 2 m
84147	1,25€	Clip de sujeción / Support clip / Clip support
84148	1,10€	Tapa final / End cap / Embout de fermeture finale
84149	1,10€	Tapa inicial / Initial cover / Embout de fermeture initiale
84150	1,15€	Tapa inicial lateral / Side initial cover / Embout de fermeture initiale latérale



MONTANA

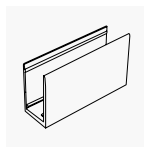

84156

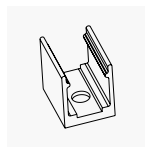

84147

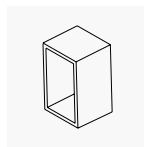

84148

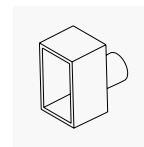

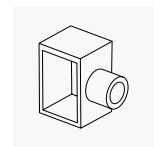

84149







84150

Power 15 W/m Life Time 75.000 h PCB Thickness 3 oz

Voltage 24V SDMC ≤ 3

CODE	CCT (K)	LUMEN OUTPUT	PRICE
84175	 RGB+W 3000K	400 Lm/M	53,95€
84176	 RGB+W 4000K	420 Lm/M	53,95€

LED SMD 5050	 30 m	 196 LED/m	IP 67
 Silicone	 71.4 mm	 120°	Non Flicker

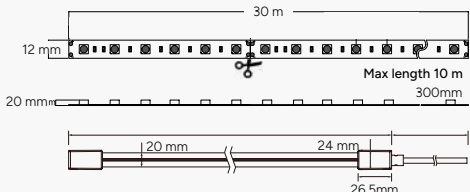

Importante instalar disipador de calor / Important to install heat sink / Important d'installer le dissipateur de chaleur / Importante installare il dissipatore di calore

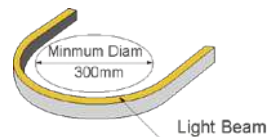
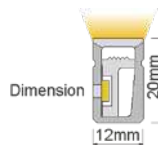
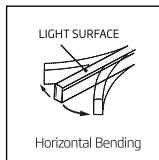

CODE	PRICE	DESCRIPTION
84168	19,95€	Perfil recto 2 m / Straight profile 2 m / Profilé droit 2 m
84164	1,25€	Clip de sujeción / Support clip / Clip support
84165	1,25€	Tapa final / End cap / Embout de fermeture finale
84166	1,25€	Tapa inicial / Initial cover / Embout de fermeture initiale
84167	1,25€	Tapa inicial lateral / Side initial cover / Embout de fermeture initiale latérale



JACKSON

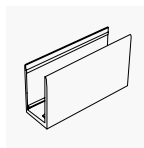

84168

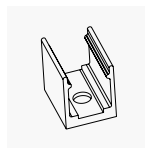

84164

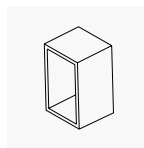

84165

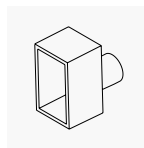

84166

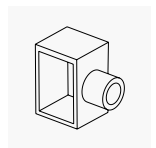

84167

Image: BORA model





Image: ORBITA accesories

ORBITA



20W/m · IP67 · 24V · CRI>90

Power 20 W/m
Life Time 75.000 h
PCB Thickness 3 oz

Voltage 24V
CRI >90
SDMC ≤3

CODE	CCT (K)	LUMEN OUTPUT	PRICE
84440	● 2700K	1200 Lm/M	79,95€
84441	● 3000K	1300 Lm/M	79,95€
84442	○ 4000K	1400 Lm/M	79,95€



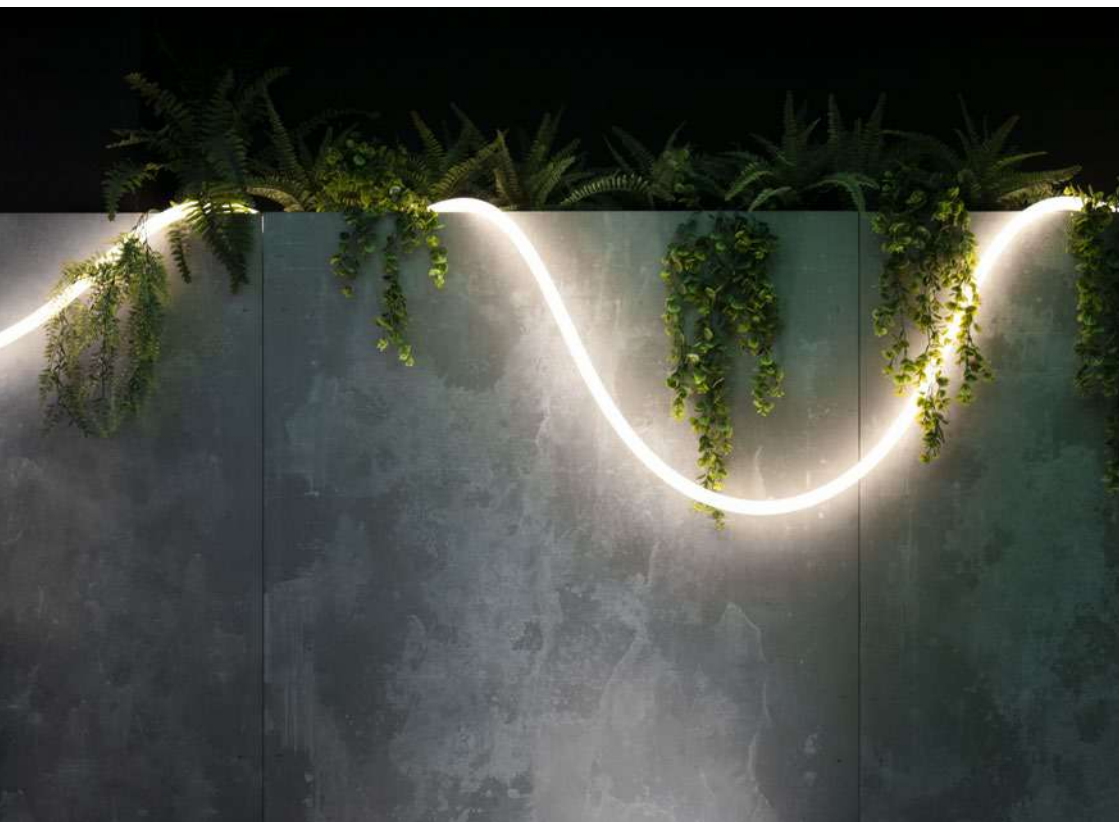

LED SMD 2835
20 m
320 LED/m
IP 67
Silicone
360°
Non Flicker
25mm











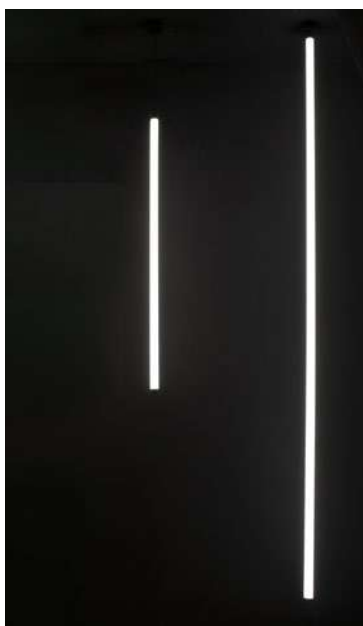





ORBITA

ACCESORIOS / ACCESSORIES / ACCESSOIRES / ACCESORI



Item	Code	Description	Price
	84444	Tapa inicial - final silicona Pack of 2 transparent silicone initial-end caps	2,45€
	84445	2 clips transparentes orbita Pack 2 transparent clips	2,75€
	84480	Tubo policarbonato 1 m Polycarbonate tube	10,95€
	84481	Kit de suspensión individual 1,25 m Single suspension kit	26,95€



Item		Color & Code	Description	Price
		○ 84447	Pack instalación lineal 1m blanco 1m linear installation pack white	29,95€
		● 84448	Pack instalación lineal 1m negro 1m linear installation pack black	
		○ 84468	Pack instalación skyline blanco Skyline installation pack white	30,95€
		● 84469	Pack instalación skyline negro Skyline installation pack black	
		○ 84453	Pack instalación U blanco U installation pack white	31,95€
		● 84454	Pack instalación U negro U installation pack black	
		○ 84456	Pack instalación libre blanco Free installation pack white	49,95€
		● 84457	Pack instalación libre negro Free installation pack black	
		○ 84459	Instalación suspensión vertical blanco Vertical suspension installation pack white	31,95€
		● 84460	Instalación suspensión vertical negro Vertical suspension installation pack black	
		○ 84462	Pack instalación superficie vertical blanco Vertical surface installation pack white	31,95€
		● 84463	Pack instalación superficie vertical negro Vertical surface installation pack black	
		○ 84465	Pack instalación cilíndrica blanco Cylindrical installation pack white	19,95€
		● 84466	Pack instalación cilíndrica negro Cylindrical installation pack black	

high voltage neon flex

ES_ Tecnología LED lineal flexible a 230V para iluminación de uso interior o exterior a nivel profesional, con distintas opciones en potencias y temperaturas de color, siempre con altas prestaciones en eficiencia energética. Con el Neón LYOPRO a 230V, podemos alcanzar hasta 50 metros sin caída de tensión, lo que facilita las instalaciones.

EN_ Flexible linear LED technology at 230V, for lighting for indoor or outdoor use at a professional level, where there are different options in power, color temperatures and always with high performance in energy efficiency. With 230V LYOPRO Neon we can do up to 50 meters without voltage drop, which makes installation easier.

FR_ Technologie LED linéaire flexible à 230V, pour l'éclairage à usage intérieur ou extérieur à un niveau professionnel, où il existe différentes options de puissance, de températures de couleur et toujours avec des performances élevées en matière d'efficacité énergétique. Avec 230V LYOPRO Neon nous pouvons faire jusqu'à 50 mètres sans chute de tension, ce qui facilite l'installation.

IT_ Tecnologia LED lineare flessibile a 230V per l'illuminazione di interni ed esterni a livello professionale, con diverse opzioni di potenza e temperatura di colore, sempre con elevate prestazioni di efficienza energetica. Con il Neón LYOPRO a 230V possiamo raggiungere i 50 metri di distanza senza cali di tensione, il che facilita le installazioni.

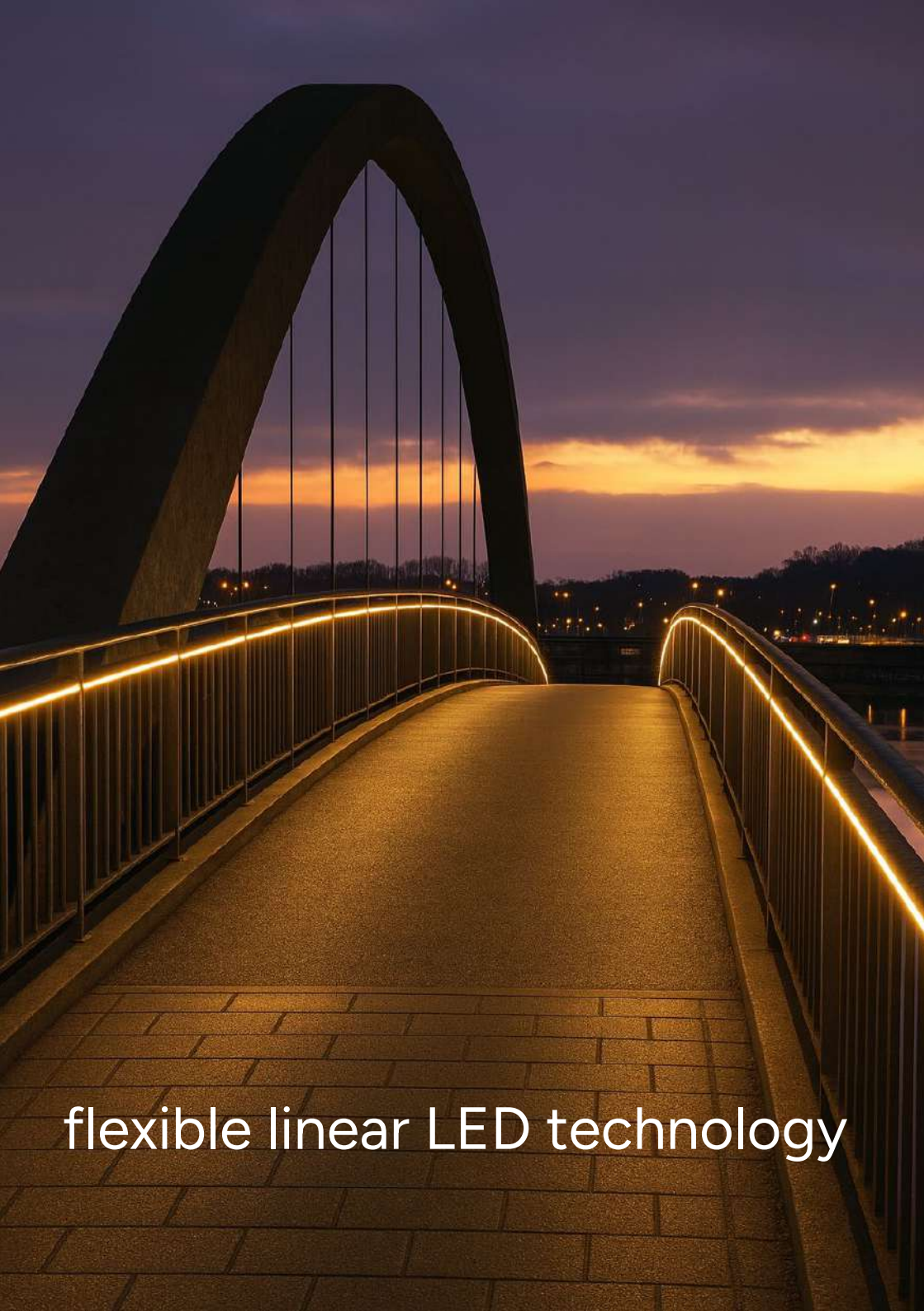

flexible linear LED technology

ASPEN



NEON FLEX

12W/m · IP65 · 230V · CRI>80

Power 12 W/m Life Time 75.000 h PCB Thickness 3 oz

Voltage 230V CRI >80 SDMC ≤3

CODE	CCT (K)	LUMEN OUTPUT	PRICE
84300	2700K	360 Lm/M	29,95€
84301	3000K	370 Lm/M	29,95€
84302	4000K	380 Lm/M	29,95€
84303	6000K	390 Lm/M	29,95€
84304	Red	100 Lm/M	32,95€
84305	Blue	75 Lm/M	32,95€
84306	Green	350 Lm/M	32,95€
84307	Yellow	320 Lm/M	32,95€
84308	Pink	190 Lm/M	32,95€

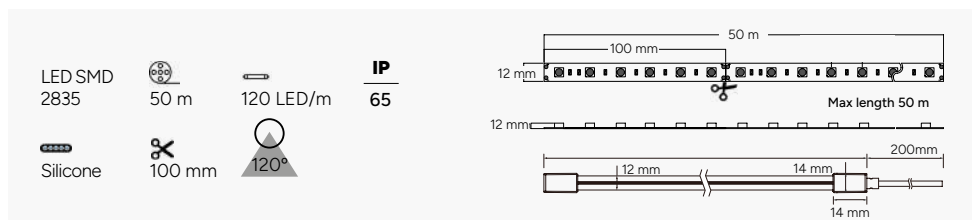

Importante instalar disipador de calor / Important to install heat sink / Important d'installer le dissipateur de chaleur / Importante installare il dissipatore di calore

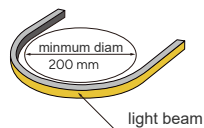
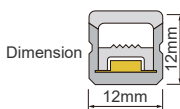
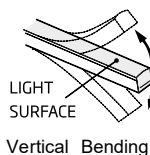
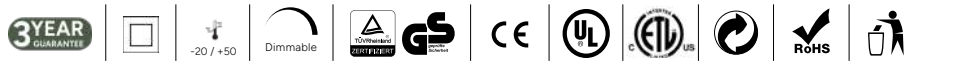

CODE	PRICE	DESCRIPTION
84314	20,95€	Perfil recto 2 m / Straight profile 2 m / Profilé droit 2 m
84311	1,45€	Clip de sujeción / Support clip / Clip support
84310	1,15€	Tapa final / End cap / Embout de fermeture finale
84309	1,15€	Tapa inicial / Initial cover / Embout de fermeture initiale



ASPEN

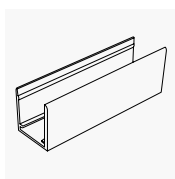

84314

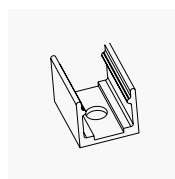

84311

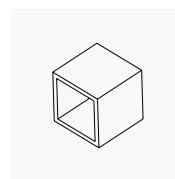

84310

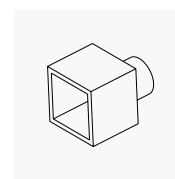

84309

PALMER



NEON FLEX

12W/m · IP65 · 230V · CRI>80

Power 12 W/m Life Time 75.000 h PCB Thickness 3 oz

Voltage 230V CRI >80 SDMC ≤3

CODE	CCT (K)	LUMEN OUTPUT	PRICE
84330	2700K	360 Lm/M	32,95€
84331	3000K	370 Lm/M	32,95€
84332	4000K	380 Lm/M	32,95€
84333	6000K	390 Lm/M	32,95€
84334	Red	100 Lm/M	34,95€
84335	Blue	75 Lm/M	34,95€
84336	Green	350 Lm/M	34,95€
84337	Yellow	320 Lm/M	34,95€
84338	Pink	190 Lm/M	34,95€

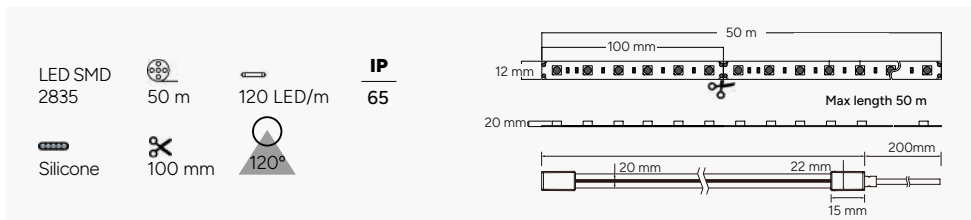

Importante instalar disipador de calor / Important to install heat sink / Important d'installer le dissipateur de chaleur / Importante installare il dissipatore di calore

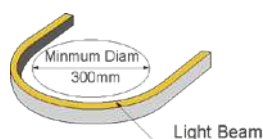
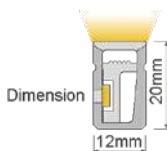
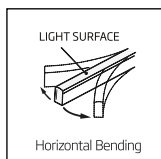

CODE	PRICE	DESCRIPTION
84344	20,95€	Perfil recto 2 m / Straight profile 2 m / Profilé droit 2 m
84341	1,45€	Clip de sujeción / Support clip / Clip support
84340	1,15€	Tapa final / End cap / Embout de fermeture finale
84339	1,15€	Tapa inicial / Initial cover / Embout de fermeture initiale



PALMER

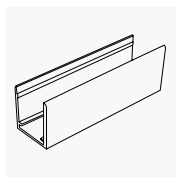

84344

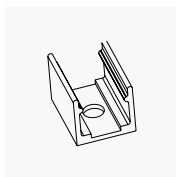

84341

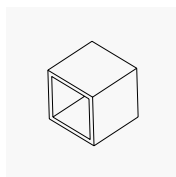

84340

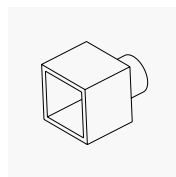

84339

digital lighting

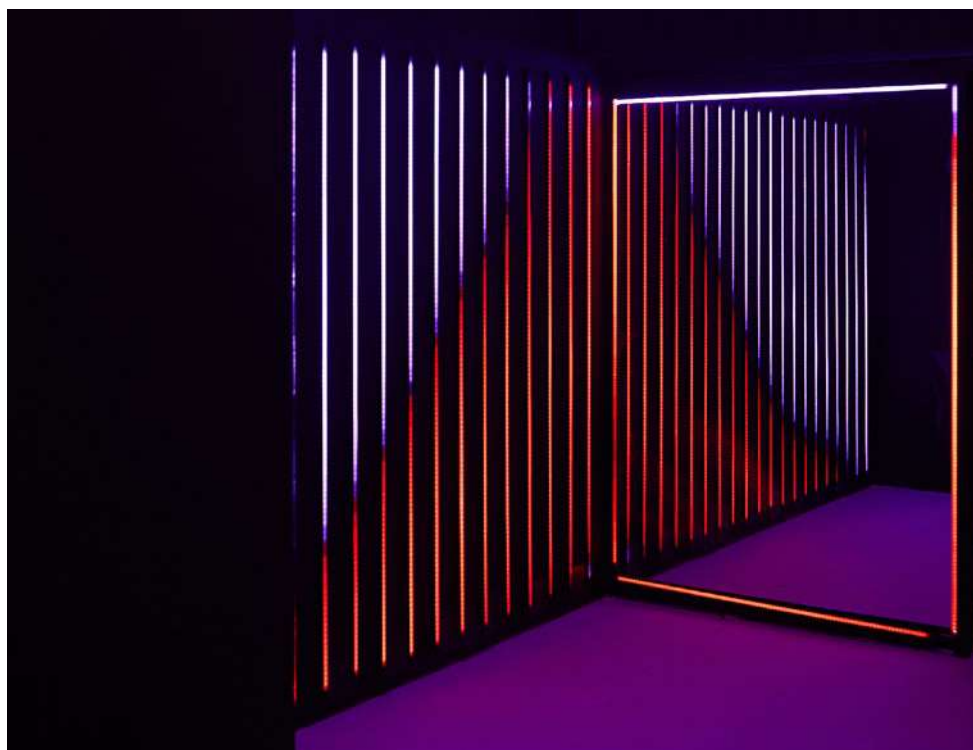

ES_ Realizamos proyectos de iluminación digital bajo proyecto. Consúltanos para darte información.
EN_ Available on request. FR_ Système sur project. IT_ Sistema su progetto

A laptop is shown from a low angle, open, with a vibrant purple and blue light effect emanating from the screen and keyboard area. The light creates a glowing, ethereal atmosphere. The text "Control the light. Control the sensations." is overlaid in white, centered on the laptop's keyboard.

Control the light. Control the sensations.

Qué es y qué puede hacer la iluminación digital

ES_ La iluminación digital redefine el control de la luz.

La iluminación digital se basa en sistemas LED avanzados que permiten controlar cada píxel de forma individual para crear escenas dinámicas, transiciones de color, variaciones de intensidad y efectos animados con total libertad.

EN_ Digital lighting redefines light control.

Digital lighting is based on advanced LED systems that allow each pixel to be managed individually, creating dynamic scenes, color transitions, intensity variations and animated effects with total freedom.

FR_ L'éclairage digital redéfinit le contrôle de la lumière.

L'éclairage digital repose sur des systèmes LED avancés permettant de gérer chaque pixel individuellement afin de créer des scènes dynamiques, des transitions de couleur, des variations d'intensité et des effets animés en toute liberté.

IT_ L'illuminazione digitale ridefinisce il controllo della luce.

L'illuminazione digitale si basa su sistemi LED avanzati che consentono di gestire ogni pixel in modo individuale, creando scenari dinamici, transizioni di colore, variazioni di intensità ed effetti animati con la massima libertà.

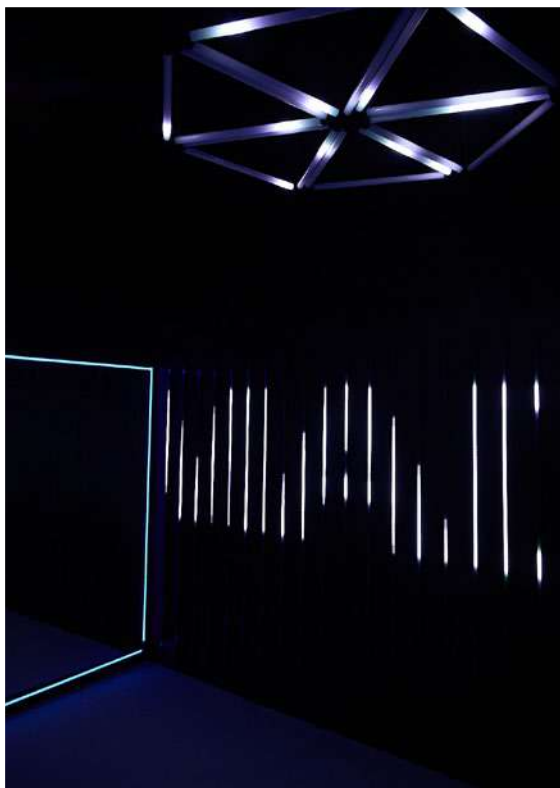

Un programa fácil, a tu gusto e intuitivo.

ES_ Mediante el software MADRIX, cada proyecto cobra vida con una programación personalizada y fluida. Su versatilidad la convierte en la elección perfecta para proyectos arquitectónicos, espacios comerciales e instalaciones artísticas, donde la luz se convierte en una herramienta expresiva y diferenciadora.

EN_ Through MADRIX software, each project comes to life with personalized and seamless programming. Its versatility makes it the perfect choice for architectural projects, commercial spaces and artistic installations, where light becomes an expressive and distinctive tool.

FR_ Grâce au logiciel MADRIX, chaque projet prend vie avec une programmation personnalisée et fluide. Sa polyvalence en fait le choix idéal pour les projets architecturaux, les espaces commerciaux et les installations artistiques, où la lumière devient un outil expressif et distinctif.

IT_ Attraverso il software MADRIX, ogni progetto prende vita con una programmazione personalizzata e fluida. La sua versatilità la rende la scelta ideale per progetti architettonici, spazi commerciali e installazioni artistiche, dove la luce diventa uno strumento espressivo e distintivo.



Cada proyecto es único.

DISEÑO. DESIGN. CONCEPTION. PROGETTAZIONE



ES_ Cada idea comienza con un diseño, nosotros nos encargamos de darle vida a ese proyecto.

EN_ Every idea begins with a design — we take care of bringing your project to life.

FR_ Chaque idée commence par une conception — nous nous chargeons de donner vie à votre projet.

IT_ Ogni idea nasce da un progetto — ci occupiamo di dare vita alla tua visione.

FABRICACIÓN. MANUFACTURING. FABBRICAZIONE. PRODUZIONE.



ES_ Elaboramos y preparamos todos los productos necesarios para llevar a cabo el proyecto.

EN_ We produce and prepare all the necessary products to make the project a reality.

FR_ Nous élaborons et préparons tous les produits nécessaires à la réalisation du projet.

IT_ Realizziamo e prepariamo tutti i prodotti necessari per la realizzazione del progetto.

Cuéntanos el tuyo.

INSTALACIÓN. INSTALLATION. INSTALLAZIONE.



ES_ Asesoría integral al cliente, con planos, esquemas técnicos y funcionamiento completo del proyecto.

EN_ Comprehensive client support with plans, technical diagrams, and full project operation.

FR_ Accompagnement complet du client, avec plans, schémas techniques et fonctionnement global du projet.

IT_ Consulenza completa al cliente, con planimetrie, schemi tecnici e gestione completa del progetto.

PROGRAMACIÓN. PROGRAMMING. PROGRAMMATION. PROGRAMMAZIONE.



ES_ Programación personalizada y asistencia técnica, remota o presencial, según la complejidad del proyecto.

EN_ Customized programming and technical support, remote or on-site, depending on project complexity.

FR_ Programmation personnalisée et assistance technique, à distance ou sur site, selon la complexité du projet.

IT_ Programmazione personalizzata e assistenza tecnica, da remoto o in loco, in base alla complessità del progetto.

Create emotions with digital lighting.



ES_ Muévete al ritmo de tu imaginación. Personaliza cada destello de luz. Contacta con nosotros para realizar tu proyecto a medida.

EN_ Move to the rhythm of your imagination. Customize each flash of light. Contact us to make your custom project.

FR_ Bougez au rythme de votre imagination. Personnalisez chaque éclat de lumière. Contactez-nous pour créer votre projet sur mesure.

IT_ Muovetevi al ritmo della vostra immaginazione. Personalizzate ogni lampo di luce. Contattateci per creare il vostro progetto su misura.

neon flex ambientes exigentes

ES_ LYOPRO ha desarrollado una amplia gama de tiras de neón de alta calidad para aplicaciones de iluminación profesional y de alto rendimiento, ofreciendo soluciones para las instalaciones más exigentes, desde piscinas y aguas termales hasta saunas, entre otras.

EN_ LYOPRO has developed a wide range of high quality Neon strips for professional lighting applications and with high performance to be able to provide solutions in the most demanding installations, ranging from swimming pools, hot springs, saunas, etc.

FR_ LYOPRO a développé une large gamme de bandes néon de haute qualité pour des applications d'éclairage professionnelles et avec des performances élevées pour pouvoir fournir des solutions dans les installations les plus exigeantes, allant des piscines, sources chaudes, saunas, etc.

IT_ LYOPRO ha sviluppato un'ampia gamma di strisce di neon di alta qualità per applicazioni di illuminazione professionale e ad alto rendimento, per poter fornire soluzioni nelle installazioni più esigenti, dalle piscine alle acque termali, fino alle saune, ecc.



HYDRA SWIMMING POOL

La solución para piscinas



Anti Yellowing

Tecnología anti-yellowing que mantiene su color intacto con el paso del tiempo, preservando su estética original.



300 mm Min. Bending Diameter

Mínimo diámetro de curvatura de 300 mm, permitiendo instalaciones flexibles y precisas



5 metros de profundidad

Clasificación IP68, sumergible permanentemente para piscinas, elementos acuáticos, fuentes y más.



UV resistant

Fórmula resistente a la radiación solar, preservando el material y garantizando un rendimiento duradero.



Fresh Water



Sea Water
(Salinity=4%)



Swimming pool
(Chlorines=2PPM)



Swimming pool
(Ozone=0.3PPM)



Spring Water
(conditions are restricted)

ES_ La serie HYDRA, un neón LED flexible con clasificación IP68, redefine la libertad en el diseño de iluminación subacuática para aplicaciones tanto en interiores como en exteriores. Ofrece una luz continua en línea, múltiples opciones de color, longitudes personalizables y dos direcciones de curvatura, adaptándose perfectamente a cualquier proyecto. Diseñada como luminaria subacuática profesional, cuenta con certificación UL 676 y garantiza resistencia al óxido, al cloro y a los rayos UV, habiendo superado rigurosas pruebas de calidad.

EN_ The HYDRA series, a flexible IP68-rated LED neon, redefines freedom in underwater lighting design for both indoor and outdoor applications. It offers continuous in-line light, multiple colour options, customisable lengths and two directions of curvature, adapting perfectly to any project. Designed as a professional underwater luminaire, it is UL 676 certified and guarantees resistance to rust, chlorine and UV rays, having passed rigorous quality tests.





FR_ La série HYDRA, un néon LED flexible conforme à la norme IP68, redéfinit la liberté dans la conception de l'éclairage sous-marin pour les applications intérieures et extérieures. Elle offre une lumière continue en ligne, de multiples options de couleurs, des longueurs personnalisables et deux sens de courbure, s'adaptant ainsi parfaitement à tout projet. Conçu comme un luminaire sous-marin professionnel, il est certifié UL 676 et garantit une résistance à la rouille, au chlore et aux rayons UV, après avoir subi des tests de qualité rigoureux.

IT_ La serie HYDRA, un neon LED flessibile con grado di protezione IP68, ridefinisce la libertà di progettazione dell'illuminazione subacquea per applicazioni interne ed esterne. Offre una luce continua in linea, molteplici opzioni di colore, lunghezze personalizzabili e due direzioni di curvatura, adattandosi perfettamente a qualsiasi progetto. Progettato come apparecchio subacqueo professionale, è certificato UL 676 e garantisce la resistenza alla ruggine, al cloro e ai raggi UV, avendo superato rigorosi test di qualità.

HYDRA POOL

12W/m · IP68 · 24V

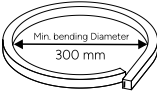
MODEL	16*17 mm	CCT (K)	LUMEN OUTPUT	Min. \varnothing	Max. length
Bending options					
Horizontal bending		Vertical bending		Min. bending	
		● 2200K	790 Lm/M	55.6 mm	10 m
		● 2700K	800 Lm/M	55.6 mm	10 m
		● 3000K	860 Lm/M	55.6 mm	10 m
		○ 4000K	860 Lm/M	55.6 mm	10 m
		● 5700K	860 Lm/M	55.6 mm	10 m
		● Red- 8W/m	240 Lm/M	83.3 mm	10 m
		● Blue	140 Lm/M	55.6 mm	10 m
		● Green	640 Lm/M	55.6 mm	10 m
Material silicone		● RGB	Vertical 370 Lm/M Horizontal 290 Lm/M	83.3 mm	10 m

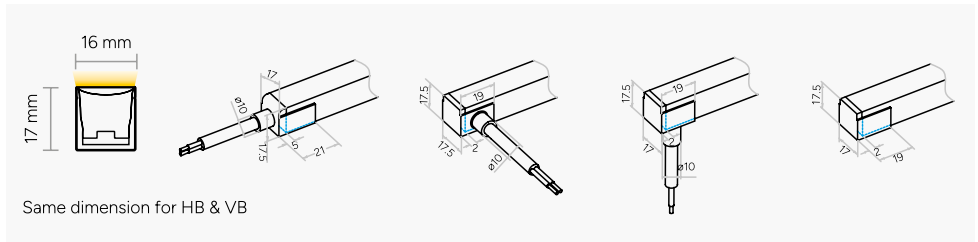

INSTALLATION POSITIONS

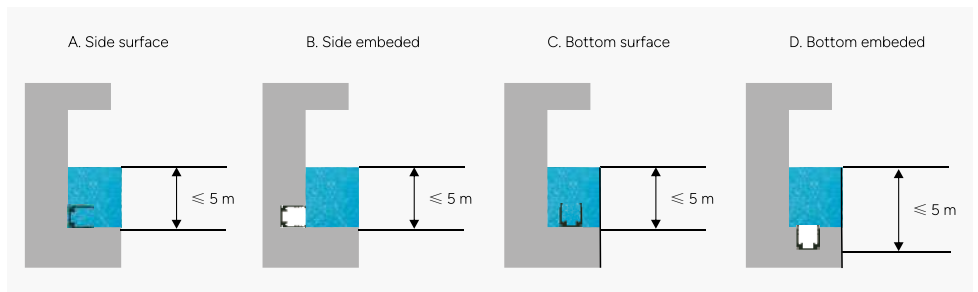

*Más opciones disponibles bajo proyecto / Additional options available upon request / Options supplémentaires disponibles sur demande / Opzioni aggiuntive disponibili su richiesta.

HYDRA POOL

HYDRA · 12W/m · IP68 · 24V

CONNECTOR OPTION

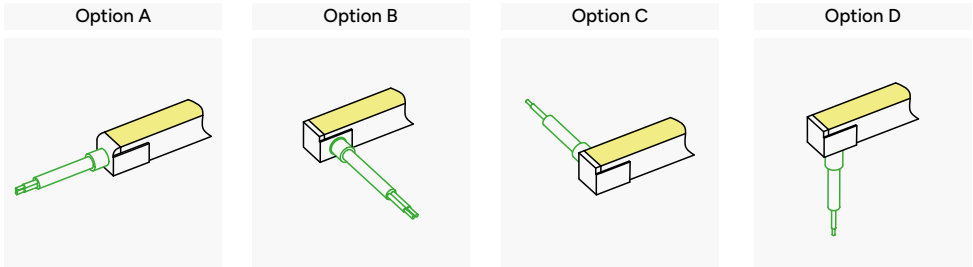

AVAILABLE PROFILES

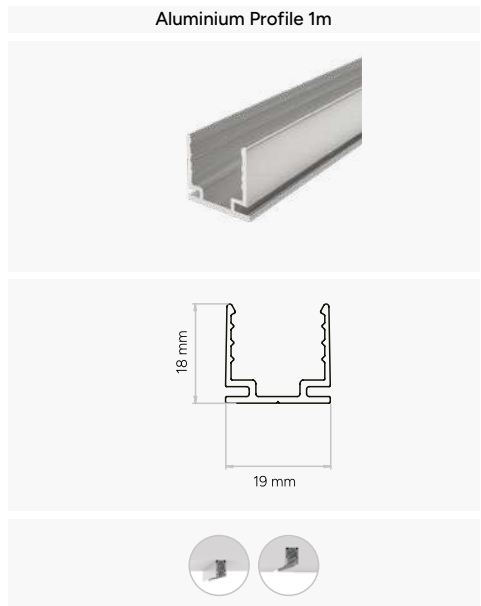
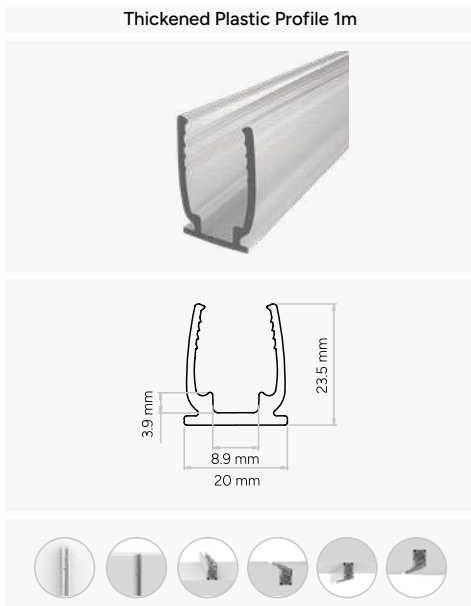



HYDRA TERMAL

LED FLEX para aguas termales



Anti Yellowing

Tecnología anti-yellowing que mantiene su color intacto con el paso del tiempo, preservando su estética original.



Resistencia al agrietamiento

HYDRA LED FLEX LINEAR está recubierto de silicona para resistir de la mejor manera a la formación de grietas.



Sumergible

La carcasa de silicona extruida y el conector inyectado de silicona permiten una clasificación de impermeabilidad IP68.



300 mm Min. Bending Diameter

Mínimo diámetro de curvatura de 300 mm, permitiendo instalaciones flexibles y precisas.



UV resistant

Fórmula resistente a la radiación solar, preservando el material y garantizando un rendimiento duradero.



Libertad en el diseño

Disponibles en dos direcciones de curvatura permitiendo mayor flexibilidad y adaptabilidad a formas irregulares.

ES_ La tira de luz flexible HYDRA está especialmente diseñada para aplicaciones en aguas termales. Su carcasa de silicona, de naturaleza altamente estable, minimiza las reacciones químicas con los microelementos presentes en el agua, lo que le permite permanecer sumergida durante largos períodos sin deteriorarse. Gracias a su flexibilidad, el neón LED HYDRA puede adaptarse a diversas formas o integrarse en el interior de jacuzzis, ofreciendo infinitas posibilidades de diseño y ambientación.

EN_ The HYDRA flexible light strip is specially designed for thermal water applications. Its highly stable silicone housing minimises chemical reactions with the micro-elements present in the water, allowing it to remain submerged for long periods without deteriorating. Thanks to its flexibility, the HYDRA LED neon can be adapted to various shapes or integrated into the interior of hot tubs, offering endless design and ambience possibilities.

FR_ La bande lumineuse flexible HYDRA est spécialement conçue pour les applications dans l'eau thermale. Son boîtier en silicone très stable minimise les réactions chimiques avec les micro-éléments présents dans l'eau, ce qui lui permet de rester immergé pendant de longues périodes sans se détériorer. Grâce à sa flexibilité, le néon HYDRA LED peut être adapté à différentes formes ou intégré à l'intérieur des spas, offrant ainsi des possibilités infinies de design et d'ambiance.

IT_ La striscia luminosa flessibile HYDRA è stata progettata appositamente per le applicazioni in acqua termale. Il suo alloggiamento in silicone altamente stabile riduce al minimo le reazioni chimiche con i microelementi presenti nell'acqua, consentendole di rimanere immersa per lunghi periodi senza deteriorarsi. Grazie alla sua flessibilità, il neon HYDRA LED può essere adattato a varie forme o integrato all'interno delle vasche idromassaggio, offrendo infinite possibilità di design e ambientazione.



HYDRA TERMAL

6W/m · IP68 · 24V

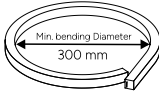
MODEL	16*17 mm	CCT (K)	LUMEN OUTPUT	Min. \varnothing	Max. length
Bending options		● 2200K	300 Lm/M	55.6 mm	10 m
Horizontal bending	Vertical bending	● 2700K	300 Lm/M	55.6 mm	10 m
		● 3000K	330 Lm/M	55.6 mm	10 m
Min. bending 		○ 4000K	330 Lm/M	55.6 mm	10 m
		● 5700K	330 Lm/M	55.6 mm	10 m
Material silicone		● RGB+W	Vertical 215 Lm/M Horizontal 177 Lm/M	83.3 mm	10 m
		● RGB 4.5W/m	Vertical 150 Lm/M Horizontal 127 Lm/M	83.3 mm	10 m

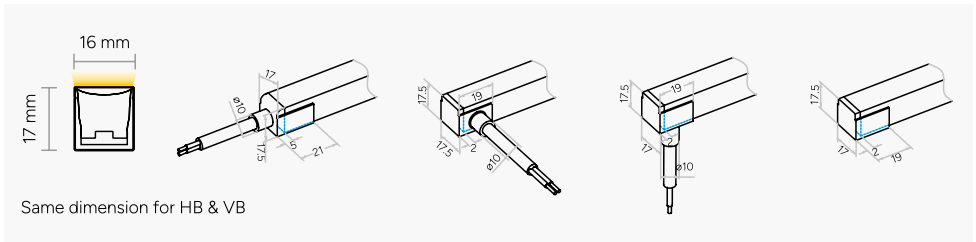

INSTALLATION POSITIONS

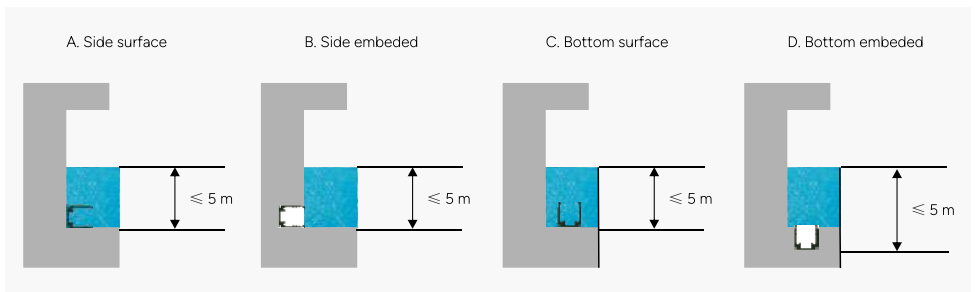

*Más opciones disponibles bajo proyecto / Additional options available upon request / Options supplémentaires disponibles sur demande / Opzioni aggiuntive disponibili su richiesta.

HYDRA TERMAL

HYDRA · 6W/m · IP68 · 24V

CONNECTOR OPTION

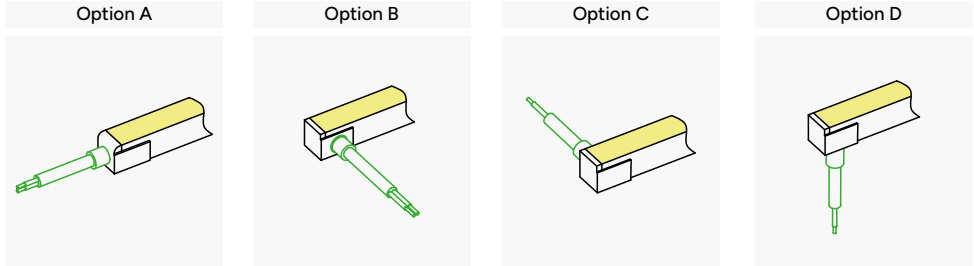

AVAILABLE PROFILES

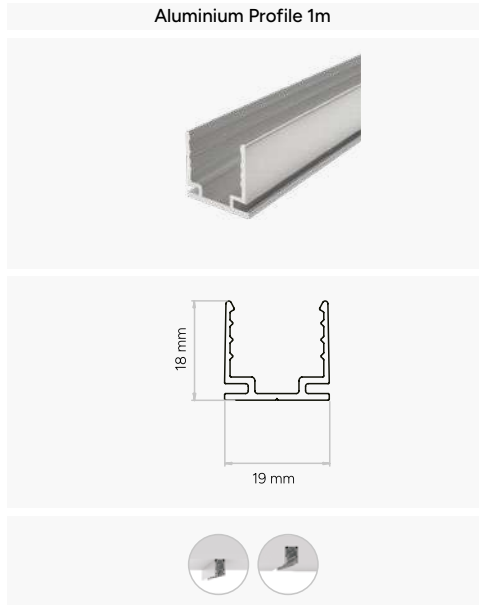
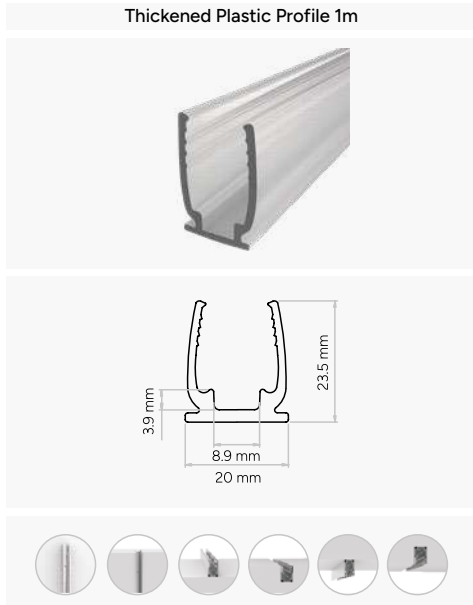



VOLCAN

La solución para saunas



Resistencia al calor hasta 95°C
Su estructura ofrece una buena gestión térmica y evita el sobrecalentamiento.



Resistencia a la humedad hasta 100%
La carcasa de silicona extruida y el conector inyectado de silicona permiten una clasificación de impermeabilidad IP67.



Certificado de seguridad UL 676
Totalmente encapsulado en silicona y sellado por el conector moldeado por inyección resistente a la interperie



Lumenes máx. 450 Lm/M \leq 6W/m
Aplicable a altas temperatura y humedad para ambientes como sauna seca, húmeda, baño de vapor, SPA, etc.

ES_ Seguro y confiable: Su diseño de corriente constante controla la temperatura de forma automática, sin necesidad de protecciones extra. **Instalación flexible:** Puede instalarse como luz directa o indirecta, y se adapta tanto en horizontal como en vertical. **Fácil de usar:** Incluye un conector preensamblado de fábrica para que la instalación sea rápida y sin errores. **Personalizable:** Permite crear líneas de hasta 10 metros, ajustables cada 55 mm para lograr exactamente la longitud que necesitas. **Garantía de calidad:** Disfruta de 3 años de garantía, incluso si realizas varios empalmes en la misma línea. **Más eficiente:** Reduce el consumo energético y los costes de mantenimiento en comparación con las soluciones tradicionales.

EN_ Safe and stable: Its constant-current design controls temperature automatically, with no additional protection needed. **Flexible installation:** Works as direct or indirect lighting, and adapts to both horizontal and vertical layouts. **Ready to use:** Comes with a factory-preassembled connector for quick, error-free installation. **Made to measure:** Build lines up to 10 m long, adjustable every 55 mm to achieve the exact length you need. **Reliable performance:** Enjoy a 3-year warranty, even when using multiple splices in the same line. **Highly efficient:** Cuts energy consumption and maintenance costs compared to traditional lighting.

FR_ Sûr et stable : Son design à courant constant contrôle automatiquement la température, sans protection supplémentaire. **Installation flexible :** Fonctionne en lumière directe ou indirecte, s'adapte aussi bien en horizontal qu'en vertical. **Prêt à l'emploi :** Livré avec un connecteur préassemblé en usine pour une installation rapide et sans erreur. **Sur mesure :** Créez des lignes jusqu'à 10 m, ajustables tous les 55 mm pour obtenir la longueur exacte souhaitée. **Fiabilité garantie :** 3 ans de garantie, même en cas de multiples raccords sur la même ligne. **Haute efficacité :** Réduit la consommation d'énergie et les coûts de maintenance par rapport à l'éclairage traditionnel.

IT_ Sicura e stabile: Il design a corrente costante controlla automaticamente la temperatura, senza bisogno di protezioni aggiuntive. **Installazione flessibile:** Perfetta come luce diretta o indiretta, si adatta sia in orizzontale che in verticale. **Pronta all'uso:** Dotata di connettore preassemblato in fabbrica per un'installazione veloce e senza errori. **Su misura:** Consente linee fino a 10 m, regolabili ogni 55 mm per ottenere la lunghezza precisa che ti serve. **Affidabilità garantita:** 3 anni di garanzia, anche con più giunzioni nella stessa linea. **Massima efficienza:** Riduce i consumi e i costi di manutenzione rispetto all'illuminazione tradizionale.



VOLCAN

6W/m · IP67 · 24V

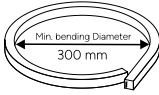
MODEL	16*17 mm	CCT (K)	LUMEN OUTPUT	Min. \varnothing	Max. length
Bending options		● 2200K	330 Lm/M	55.6 mm	10 m
Horizontal bending	Vertical bending	● 2700K	350 Lm/M	55.6 mm	15 m
		● 3000K	350 Lm/M	55.6 mm	10 m
Min. bending 		○ 4000K	350 Lm/M	55.6 mm	10 m
		● 5700K	350 Lm/M	55.6 mm	10 m
		● Red	190 Lm/M	83.3 mm	10 m
		● Blue	75 Lm/M	83.3 mm	10 m
		● Green	390 Lm/M	83.3 mm	10 m
		● Ambar	190 Lm/M	83.3 mm	10 m
Material silicone		● RGB	150 Lm/M	83.3 mm	10 m

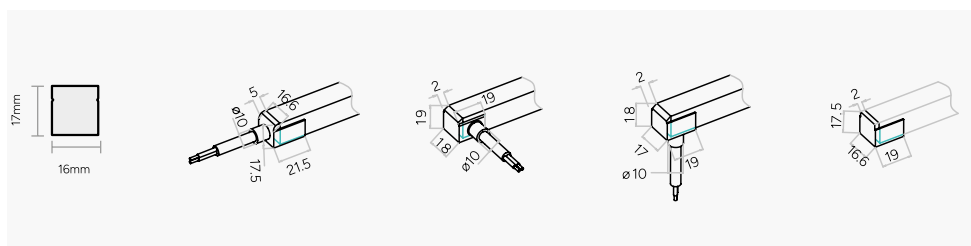

CONNECTOR OPTION

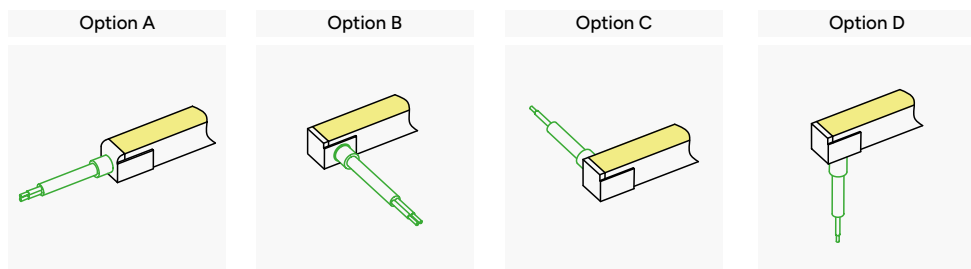

*Más opciones disponibles bajo proyecto / Additional options available upon request / Options supplémentaires disponibles sur demande / Opzioni aggiuntive disponibili su richiesta.

VOLCAN · 6W/m · IP67 · 24V

MONOCHROME

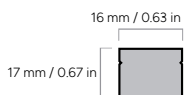

DIMENSION

Dirección de plegado	HB/VB
Voltage	24V
Corriente	250 mA/m
Power	6 W/m
Tipo de circuito	CC
Cantidad de LED/m	108 LED/m
Min. longitud de corte	55.6 mm
Min. diámetro de plegado	300 mm
Max. longitud de carrera	10 m

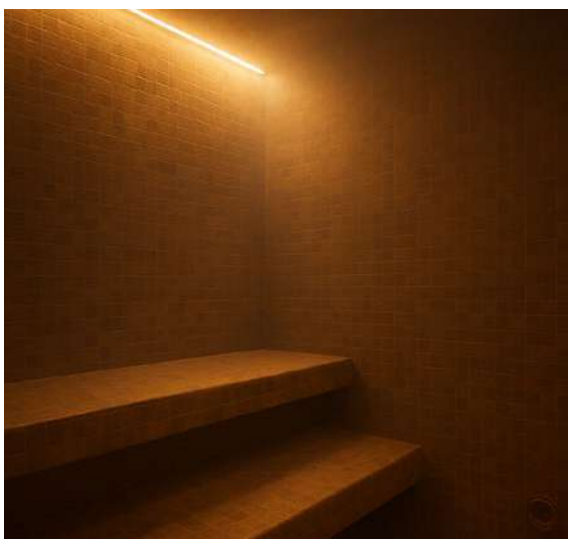

RGB

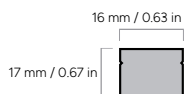

DIMENSION

Dirección de plegado	HB/VB
Voltage	24V
Corriente	250 mA/m
Power	4.5 W/m
Tipo de circuito	CC
Cantidad de LED/m	84 LED/m
Min. longitud de corte	83.3 mm
Min. diámetro de plegado	300 mm
Max. longitud de carrera	10 m

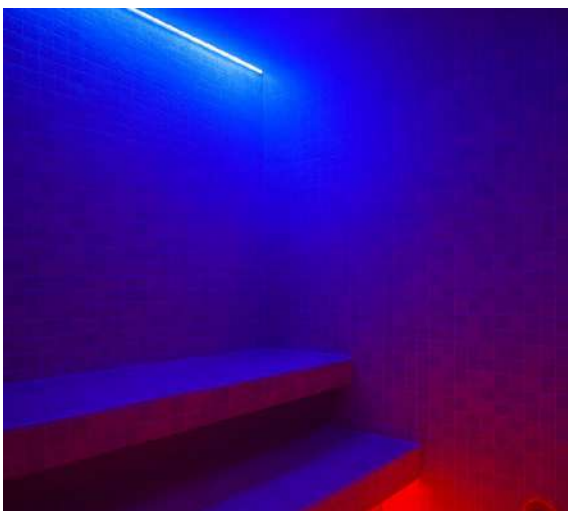

AVAILABLE PROFILES

Aluminium Profile 1000 mm

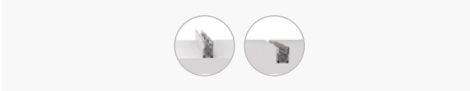
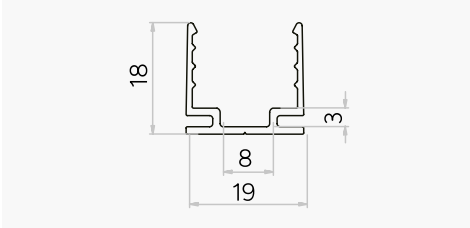

Bendable serrated aluminium profile 1000 mm

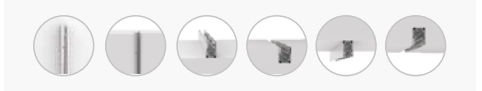
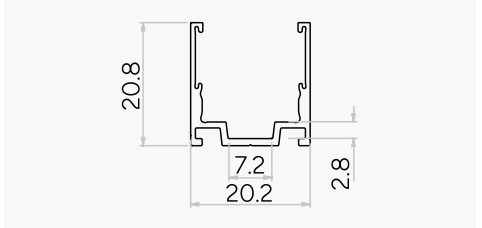

AVAILABLE STAPLE

Stainless steel staple 35 mm

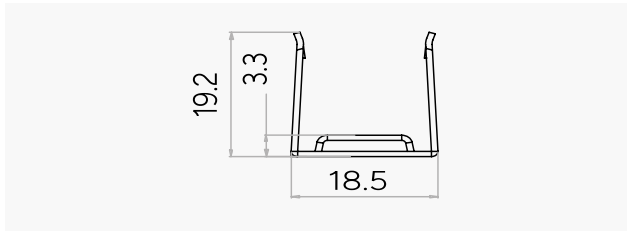

*Más opciones disponibles bajo proyecto / Additional options available upon request / Options supplémentaires disponibles sur demande / Opzioni aggiuntive disponibili su richiesta.



VOLCAN · 6W/m · IP67 · 24V



DORUK ATEX

Flex Linear light



Solvent resistant

Mantiene su integridad y durabilidad para asegurar instalaciones fiables en los entornos exigentes.



Certificaciones ATEX e IECEx

Diseño y garantía avanzada para ofrecer la máxima seguridad en atmósferas explosivas.



Sellado para condiciones exigentes

La carcasa de silicona extruida y el conector inyectado de silicona permiten una clasificación de impermeabilidad IP67.



300 mm Min. Bending Diameter

Mínimo diámetro de curvatura de 300 mm, permitiendo instalaciones flexibles y precisas



UV resistant

Fórmula resistente a la radiación solar, preservando el material y garantizando un rendimiento duradero.



Protección IK10

Resistencia máxima a impactos, ideal para entornos exigentes donde la durabilidad y la seguridad del producto son esenciales

DORUK ATEX

ES_ La luz LED flexible DORUK Ex, certificada con **ATEX e iECEx**, está diseñada para entornos extremos en la industria del petróleo y gas. Es ideal para iluminar áreas difíciles de alcanzar, resaltar contornos de escaleras y equipos peligrosos, y ofrecer apoyo en espacios pequeños.

Con opciones **RGB** y regulables, su eficiencia energética y luz sin deslumbramientos garantizan un entorno seguro y cómodo para los trabajadores.

DORUK Ex:
LED Flexible para Zonas Peligrosas

EN_ The DORUK Ex flexible LED, certified with **ATEX and iECEx**, is designed for extreme environments in the oil and gas industry. It's ideal for illuminating hard-to-reach areas, highlighting stairways and hazardous equipment, and providing support in small spaces.

With **RGB** and dimmable options, its energy efficiency and glare-free light ensure a safe and comfortable environment for workers.

DORUK Ex: Flexible LED for Hazardous Areas

FR_ Le LED flexible DORUK Ex, certifié **ATEX et iECEx**, est conçu pour les environnements extrêmes de l'industrie pétrolière et gazière. Il est idéal pour éclairer les zones difficiles d'accès, mettre en valeur les escaliers et équipements dangereux, et offrir un soutien dans les petits espaces.

Avec des options **RGB** et réglables, son efficacité énergétique et sa lumière non éblouissante garantissent un environnement sûr et confortable pour les travailleurs.

DORUK Ex : LED Flexible pour Zones Dangereuses

IT_ Il LED flessibile DORUK Ex, certificato **ATEX e iECEx**, è progettato per ambienti estremi nell'industria petrolifera e del gas. È ideale per illuminare aree difficili da raggiungere, evidenziare scale e attrezzature pericolose e fornire supporto in spazi ristretti.

Con opzioni **RGB** e regolabili, la sua efficienza energetica e la luce antiriflesso garantiscono un ambiente sicuro e confortevole per i lavoratori.

DORUK Ex: LED Flessibile per Aree Pericolose







Intertek

DORUK ATEX

Flex Linear light · 12W/m · IP67 · IK10 · 24V





	CCT (K)	LUMEN OUTPUT	Min. \varnothing	Max. length
	6500K	1000 Lm/M	83.3 mm	20 m
	Red	310 Lm/M	83.3 mm	20 m
	Green	880 Lm/M	83.3 mm	20 m
	Ambar	350 Lm/M	83.3 mm	20 m
	RGB	150 Lm/M	50.0 mm	30 m

TECHNICAL DATA

Dimension	W20mm*H10mm
IP degree of protection	IP67
Impact strength	IK10
Standards	EN IEC 60079-0 EN IEC 60079-18 EN IEC 60079-28
Weight	285g/m
Minimum bend diameter	300 mm



 I M2 Ex mb op is I Mb

 II 2G Ex mB op is IIC T6 Gb

 II 2G Ex mB op is IIIC T80°C Db

 II 2G Ex mB op is IIC T4 Gb

 II 2G Ex mB op is IIIC T135°C Db

ES_ I: Grupo I metano/polvo de carbón. **II:** Grupo II gases/polvo. **M2:** Operación donde existe riesgo de explosión ocasional. **2G:** Zona 1, 2. **2D:** Zona 21, 22. **Ex ma:** nivel muy alto de encapsulación de protección. **Ex mb:** nivel alto de encapsulación de protección. **IIC:** Gas grupo IIC hidrógeno. **IIIC:** Polvo metálico combustible.

EN_ I: Group I methane/coal dust. **II:** Group II gases/dust. **M2:** Operation where there is an occasional risk of explosion. **2G:** Zone 1, 2. **2D:** Zone 21, 22. **Ex ma:** very high level of encapsulation protection. **Ex mb:** high level of encapsulation protection. **IIC:** Gas Group IIC hydrogen. **IIIC:** Combustible metallic dust.

FR_ I: Groupe I méthane/poussière de charbon. **II:** Groupe II gaz/poussière. **M2:** Fonctionnement avec un risque occasionnel d'explosion. **2G:** Zone 1, 2. **2D:** Zone 21, 22. **Ex ma:** niveau très élevé de protection par encapsulation. **Ex mb:** niveau élevé de protection par encapsulation. **IIC:** Gaz groupe IIC hydrogène. **IIIC:** Poussière métallique combustible.

IT_ I: Gruppo I metano/polvere di carbone. **II:** Gruppo II gas/polvere. **M2:** Operazioni con rischio occasionale di esplosione. **2G:** Zona 1, 2. **2D:** Zona 21, 22. **Ex ma:** livello molto alto di protezione mediante incapsulamento. **Ex mb:** livello alto di protezione mediante incapsulamento. **IIC:** Gruppo gas IIC idrogeno. **IIIC:** Polvere metallica combustibile.

*Más opciones disponibles bajo proyecto / Additional options available upon request / Options supplémentaires disponibles sur demande / Opzioni aggiuntive disponibili su richiesta.

AVAILABLE PROFILES

Aluminium Profile 1000 mm

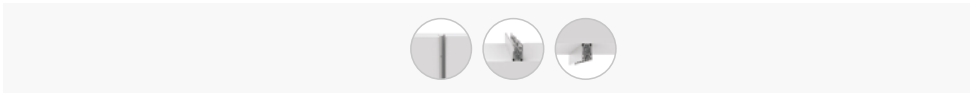
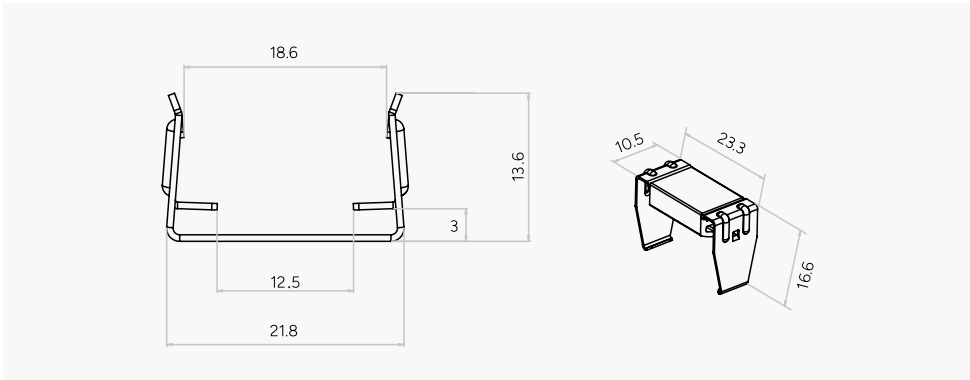
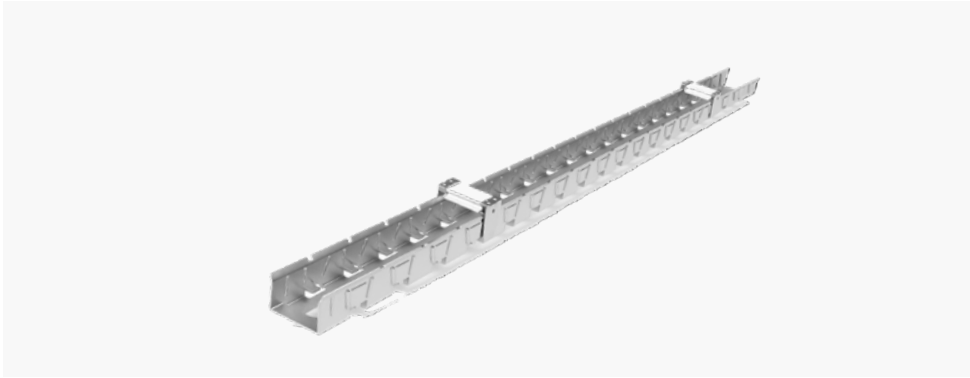



TITAN

Resistencia total para suelos exteriores



Superficie Anti-slip

Diseño texturizado de alta adherencia que minimiza el riesgo de resbalones y garantiza una instalación más segura en cualquier entorno.



Stamp On. Reforzada y pisable

Diseñada para resistir cargas de uso intensivo y garantizar un rendimiento estable incluso en zonas de tránsito continuo.



30T Drive over

Preparada para soportar hasta 30 toneladas.



1200 mm Min. Bending Diameter

Mínimo diámetro de curvatura de 1200 mm, permitiendo instalaciones flexibles y precisas



UV resistant

Fórmula resistente a la radiación solar, preservando el material y garantizando un rendimiento duradero.



Protección IP68

Protección IP68 garantiza resistencia total al agua y polvo, ofreciendo durabilidad excepcional en cualquier instalación profesional.

TITAN

ES_ La serie de luminarias lineales empotradas **TITAN** es ideal para pavimentos exteriores, ofreciendo alta resistencia al vandalismo, rayos UV, agua, corrosión y deslizamientos, además de una iluminación uniforme sin deslumbramientos. Con clasificación **IP68 & IK10**, cuenta con una carcasa metálica sólida y un difusor de silicona reforzado que garantizan robustez e impermeabilidad. Es perfecta para pasarelas, entradas de vehículos y plazas, soportando impactos y contacto con agua. Ofrece opciones de monocolor o RGB, efectos regulables y conexión sin zonas oscuras, convirtiéndola en la mejor solución para iluminación y señalización en el suelo.

EN_ The **TITAN** series of recessed linear luminaires is ideal for outdoor pavements, offering high resistance to vandalism, UV rays, water, corrosion, and slipping, as well as uniform, glare-free illumination. With an **IP68 & IK10** rating, it features a solid metal housing and a reinforced silicone diffuser that ensure robustness and waterproof performance. It is perfect for walkways, vehicle entrances, and plazas, withstanding impacts and contact with water. It offers single-color or RGB options, adjustable effects, and seamless connection with no dark zones, making it the best solution for ground lighting and signage.

FR_ La série de luminaires linéaires encastrés **TITAN** est idéale pour les revêtements extérieurs, offrant une haute résistance au vandalisme, aux rayons UV, à l'eau, à la corrosion et aux glissades, ainsi qu'un éclairage uniforme sans éblouissement. Avec une classification **IP68 & IK10**, elle dispose d'un corps métallique solide et d'un diffuseur en silicone renforcé garantissant robustesse et étanchéité. Elle est parfaite pour les passerelles, les entrées de véhicules et les places, résistant aux impacts et au contact avec l'eau. Elle offre des options monochromes ou RGB, des effets réglables et une connexion sans zones sombres, en faisant la meilleure solution pour l'éclairage et la signalisation au sol.

IT_ La serie di apparecchi lineari da incasso **TITAN** è ideale per pavimentazioni esterne, offrendo elevata resistenza al vandalismo, ai raggi UV, all'acqua, alla corrosione e allo scivolamento, oltre a un'illuminazione uniforme senza abbagliamenti. Con classificazione **IP68 & IK10**, presenta un corpo metallico solido e un diffusore in silicone rinforzato che garantiscono robustezza e impermeabilità. È perfetta per passerelle, ingressi carrabili e piazze, resistendo agli urti e al contatto con l'acqua. Offre opzioni monocolor o RGB, effetti regolabili e una connessione senza zone d'ombra, rendendola la migliore soluzione per illuminazione e segnaletica a pavimento.



TITAN

INCLUYE TODO LO NECESARIO PARA SU INSTALACIÓN

Flexible model  92*61 mm

Drive-Over 2.5 T 

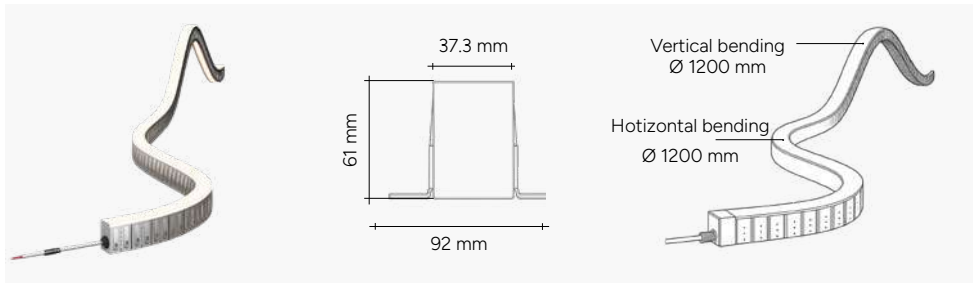

CCT (K)	LUMEN OUTPUT	Min. \angle	Max. length
2100K	480 Lm/M	55.6 mm	10 m
3000K	500 Lm/M	55.6 mm	10 m
4000K	500 Lm/M	55.6 mm	10 m
5000K	500 Lm/M	55.6 mm	10 m
RGB	240 Lm/M	83.3 mm	10 m

*Más opciones disponibles bajo proyecto / Additional options available upon request / Options supplémentaires disponibles sur demande / Opzioni aggiuntive disponibili su richiesta.

Model  80*61 mm

Walk-over. Diseñado para ser pisado de forma segura 

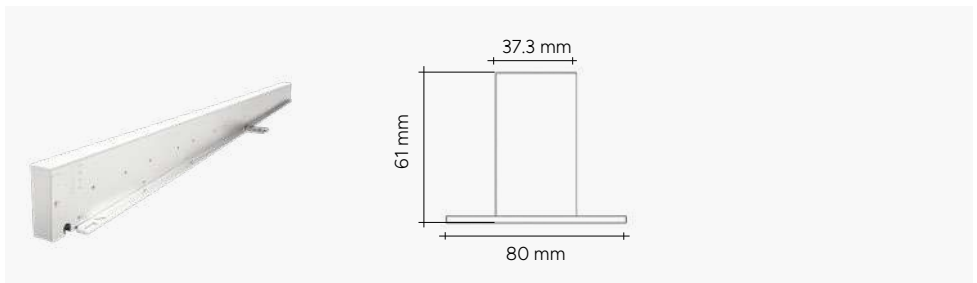

CCT (K)	LUMEN OUTPUT	Min. \angle	Max. length
2100K	360 Lm/M	55.6 mm	10 m
3000K	450 Lm/M	55.6 mm	10 m
4000K	450 Lm/M	55.6 mm	10 m
5000K	450 Lm/M	55.6 mm	10 m
RGB	245 Lm/M	83.3 mm	10 m

*Más opciones disponibles bajo proyecto / Additional options available upon request / Options supplémentaires disponibles sur demande / Opzioni aggiuntive disponibili su richiesta.















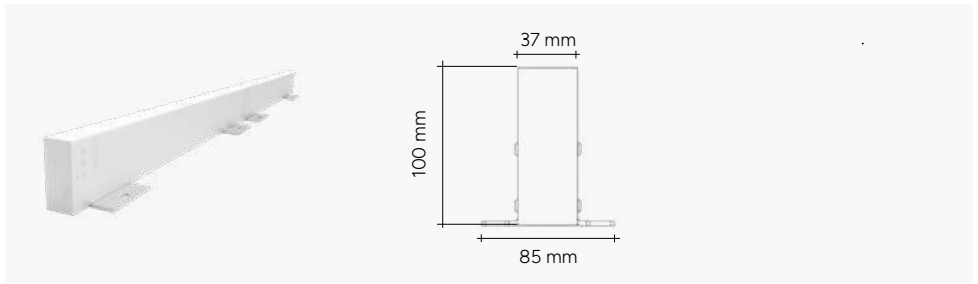

TITAN

INCLUYE TODO LO NECESARIO PARA SU INSTALACIÓN

Flexible model  85*100 mm

Drive-Over 30 T



CCT (K)	LUMEN OUTPUT	Min. \angle	Max. length
 2100K	350 Lm/M	55.6 mm	10 m
 3000K	450 Lm/M	55.6 mm	10 m
 4000K	450 Lm/M	55.6 mm	10 m
 5000K	450 Lm/M	55.6 mm	10 m
 RGB	195 Lm/M	83.3 mm	10 m

*Más opciones disponibles bajo proyecto / Additional options available upon request / Options supplémentaires disponibles sur demande / Opzioni aggiuntive disponibili su richiesta.



CONNECTOR OPTION

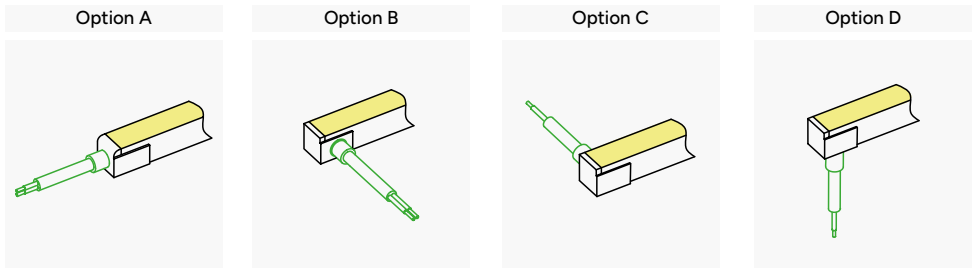



WALL STREET

La wall washer que realza fachadas y define cada muro



Anti Yellowing

Tecnología anti-yellowing que mantiene su color intacto con el paso del tiempo, preservando su estética original.



Protección IK10

Wall Street está recubierta de silicona para resistir de la mejor manera a la formación de grietas.



IP67

La carcasa de silicona extruida y el conector inyectado de silicona permiten una clasificación de impermeabilidad IP67.



UV resistant

Fórmula resistente a la radiación solar, preservando el material y garantizando un rendimiento duradero.



Libertad de diseño

Disponible en dos direcciones de curvatura permitiendo mayor flexibilidad y adaptabilidad a formas irregulares.

ES_ La elegancia que asciende desde el suelo. La tira Wall Street redefine la iluminación arquitectónica: un sistema empotrable que nace al ras del suelo y proyecta una luz limpia y uniforme sobre muros y fachadas, creando efectos verticales de gran impacto visual. Su diseño minimalista desaparece a la vista, dejando que la luz sea la protagonista y elevando la estética de cualquier espacio exterior. Perfecta para hoteles, accesos principales, zonas peatonales y fachadas, permitiendo destacar los materiales, las texturas y líneas arquitectónicas.

EN_ Elegance rising from the ground. The Wall Street strip redefines architectural lighting: a recessed system that emerges flush with the floor and projects a clean, uniform light onto walls and façades, creating vertical effects with strong visual impact. Its minimalist design disappears from sight, allowing the light to take center stage and elevating the aesthetic of any outdoor space. Perfect for hotels, main entrances, pedestrian areas, and façades, it highlights materials, textures, and architectural lines.

FR_ L'élégance qui s'élève depuis le sol. La bande Wall Street redéfinit l'éclairage architectural : un système encastré qui naît à fleur du sol et projette une lumière propre et uniforme sur les murs et façades, créant des effets verticaux à fort impact visuel. Son design minimaliste disparaît à la vue, laissant la lumière devenir la protagoniste et rehaussant l'esthétique de tout espace extérieur. Parfaite pour les hôtels, les entrées principales, les zones piétonnes et les façades, elle permet de mettre en valeur les matériaux, les textures et les lignes architecturales.

IT_ L'eleganza che si eleva dal suolo. La strip Wall Street ridefinisce l'illuminazione architettonica: un sistema a incasso che nasce a filo pavimento e proietta una luce pulita e uniforme su muri e facciate, creando effetti verticali di grande impatto visivo. Il suo design minimalista scompare alla vista, lasciando che la luce sia la protagonista ed elevando l'estetica di qualsiasi spazio esterno. Perfetta per hotel, ingressi principali, zone pedonali e facciate, permette di valorizzare materiali, texture e linee architettoniche.



WALL STREET





WALL WASHER · 24W/m · IP68 · IK10 · 24V

INCLUYE TODO LO NECESARIO PARA SU INSTALACIÓN

Flexible model  35*25 mm

Wall washer 



CCT (K)	LUMEN OUTPUT	Min. 	Max. length
 2700K	1400 Lm/M	250 mm	5 m
 3000K	1500 Lm/M	250 mm	5 m
 4000K	1600 Lm/M	250 mm	5 m
 5700K	1600 Lm/M	250 mm	5 m

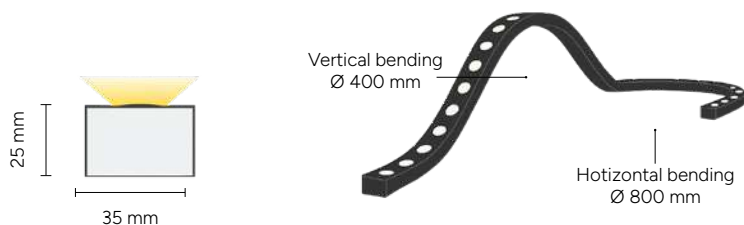

CONNECTOR OPTION

Option A

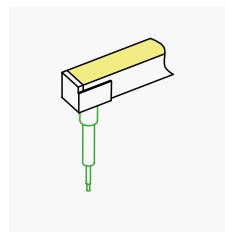

*Más opciones disponibles bajo proyecto / Additional options available upon request / Options supplémentaires disponibles sur demande / Opzioni aggiuntive disponibili su richiesta.

AVAILABLE PROFILES

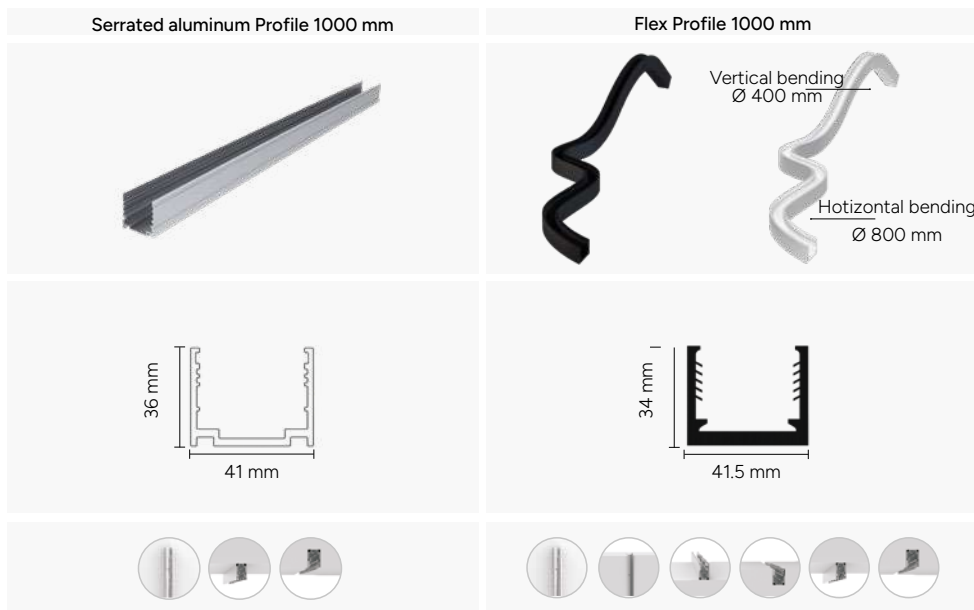

AVAILABLE STAPLE

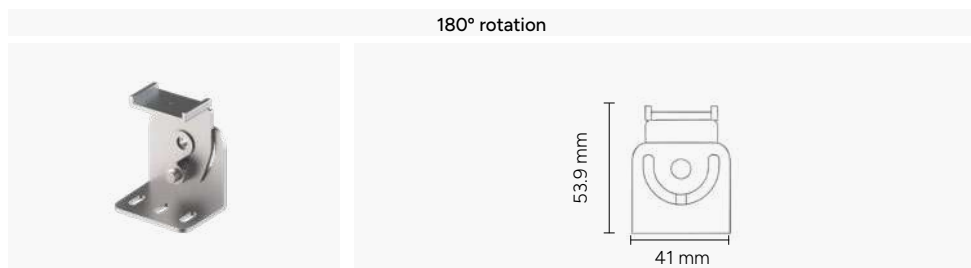

*Más opciones disponibles bajo proyecto / Additional options available upon request / Options supplémentaires disponibles sur demande / Opzioni aggiuntive disponibili su richiesta.

perfilería

Perfilería

Profiles

Profilage

Profili

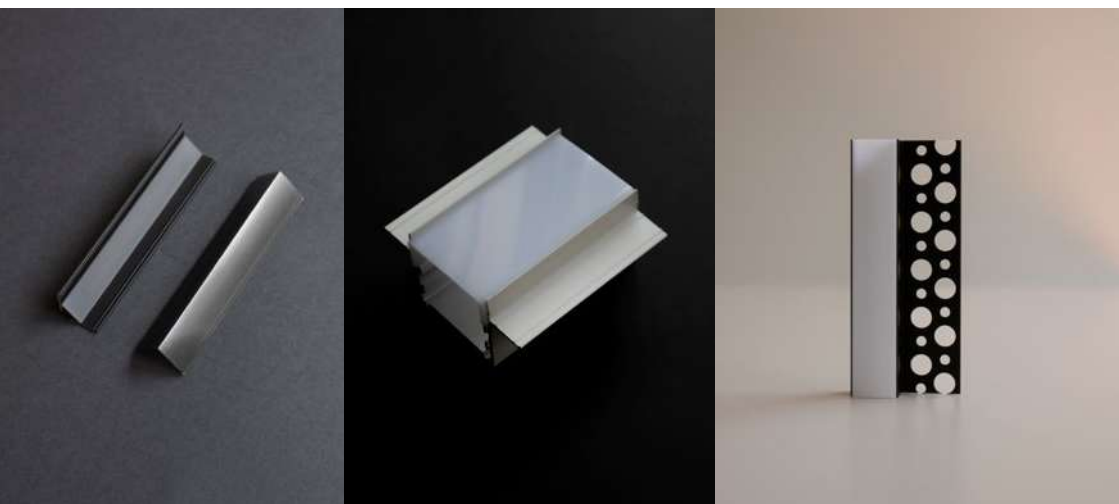

ES_ Perfilera de aluminio que actua como disipador de calor de nuestras tiras led. Con mas de 50 modelos en stock, en diferentes acabados, nos facilitan multitud de soluciones para poder acometer cualquier proyecto.

EN_ Aluminum profiles that act as a heat sink for our led strips. With more than 50 models in stock, in different finishes, they provide us with a multitude of solutions to be able to undertake any project.

FR_ Profilés en aluminium qui agissent comme dissipateur thermique pour nos rubans led. Avec plus de 50 modèles en stock, dans différentes finitions, ils nous offrent une multitude de solutions pour pouvoir entreprendre n'importe quel projet.

IT_ Perfilera in alluminio che funge da dissipatore di calore per i nostri LED. Con più di 50 modelli in stock, in una gamma di finiture differenti, siamo in grado di facilitiamo una molteplicità di soluzioni per poter realizzare qualsiasi progetto.

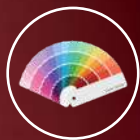

Personaliza el acabado para adaptarte a las necesidades estéticas de cada proyecto.

Haz que el color de nuestros perfiles acompañe a la estética de tu proyecto. Contáctanos para estudiar tu caso y conseguir una integración total con el espacio. Servicio disponible bajo proyecto.



Discover

everything

about

profiles



perfilería de superficie



Perfilería de superficie

ES_ Nuestros perfiles de superficie permiten una instalación sencilla y elegante, mejorando la distribución de la luz y protegiendo las tiras LED. Ideales para cualquier proyecto, ofrecen un acabado profesional sin ocupar espacio visible.

Surface profiling

EN_ Our surface profiles allow a simple and elegant installation, improving light distribution and protecting the LED strips. Ideal for any project, they offer a professional finish without taking up visible space.

Profilage de la surface

FR_ Nos profilés de surface permettent une installation simple et élégante, améliorant la distribution de la lumière et protégeant les bandes LED. Idéaux pour tous les projets, ils offrent une finition professionnelle sans occuper d'espace visible.

Profili superficie

IT_ I nostri profili di superficie consentono un'installazione semplice ed elegante, migliorando la distribuzione della luce e proteggendo le strisce LED. Ideali per qualsiasi progetto, offrono una finitura professionale senza occupare spazio.



Todos los perfiles han sido fabricados con aluminio extrusionado y anodizado y diseñados como disipadores de tiras LED. / Made of extruded and anodised aluminium. Designed as a LED strip heatsink / Fabriqué en aluminium extrudé et anodisé. Conçu comme un dissipateur de chaleur pour bande LED / In alluminio estruso e anodizzato. Progettato come dissipatore per strisce LED.

RIAD

Perfil de superficie / Surface profile / Profile de surface / Profilo di superficie



CODE	COLOR	SIZE	PRICE
85240	● Plata / Silver / Argent / Argento	2 m	10,95€
85241	● Plata / Silver / Argent / Argento	3 m*	15,95€

Power
Max 30W/m

Material
AL 6063



IP
20

 Customised

Escala / Scale / Échelle / Scala 1:1

Difusor / Diffuser / Diffuseurs / Diffusore

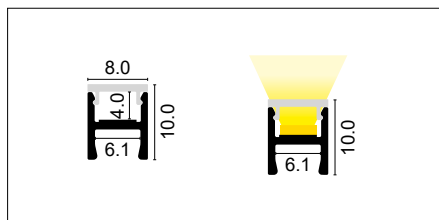

CODE	COLOR	SIZE	PRICE
85606	● Opal / Opale	2 m	7,95€
85607	● Opal / Opale	3 m	11,95€

Grapas / Staples / Agrafes / Graffete

Tapas / Caps / Embout / Coperture



CODE	COLOR	PRICE
85246	● Aluminio / Aluminium / Alluminio	1,25€

CODE	COLOR	PRICE
85245	● Plata / Silver / Argent / Argento	1,35€

*Coste de envío a consultar en condiciones generales de venta. Shipping costs to be consulted in the general conditions of sale. Frais d'expédition à consulter dans les conditions générales de vente. Costi di spedizione da consultare nelle condizioni generali di vendita.

DOHA

Perfil de superficie / Surface profile / Profile de surface / Profilo di superficie



CODE	COLOR	SIZE	PRICE
85250	● Plata / Silver / Argent / Argento	2 m	7,95€
85251	○ Blanco / White / Blanc / Bianco	2 m	8,95€

Power
Max 30W/m

Material
AL 6063



IP
20

 Customised

Escala / Scale / Échelle / Scala 1:1

Difusor / Diffuser / Diffuseurs / Diffusore

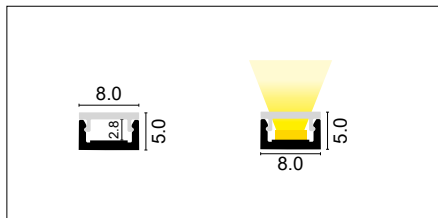

CODE	COLOR	SIZE	PRICE
85606	● Opal / Opale	2 m	7,95€

Tapas / Caps / Embout / Coperture



CODE	COLOR	PRICE
85245	● Plata / Silver / Argent / Argento	1,35€

LEON

Perfil de superficie / Surface profile / Profile de surface / Profilo di superficie



CODE	COLOR	SIZE	PRICE
85270	● Plata / Silver / Argent / Argento	2 m	10,95€
85271	○ Blanco / White / Blanc / Bianco	2 m	11,25€

Power
Max 30W/m

Material
AL 6063



IP
20

 Cutomised

Escala / Scale / Échelle / Scala 1:1

Difusor / Diffuser / Diffuseurs / Diffusore

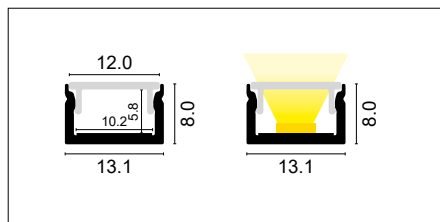

CODE	COLOR	SIZE	PRICE
85638	● Opal / Opale	2 m	8,95€

Grapas / Staples / Agrafes / Graffete

Tapas / Caps / Embout / Coperture



CODE	COLOR	PRICE
85285	● Aluminio / Aluminium / Alluminio	1,95€

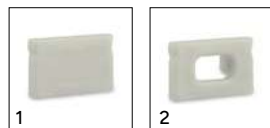

CODE 1	COLOR	PRICE
85279	● Plata / Silver / Argent / Argento	0,99€
85281	○ Blanco / White / Blanc / Bianco	0,99€

CODE 2	COLOR	PRICE
85278	● Plata / Silver / Argent / Argento	0,99€
85280	○ Blanco / White / Blanc / Bianco	0,99€

MUNICH

Perfil de superficie / Surface profile / Profile de surface / Profilo di superficie

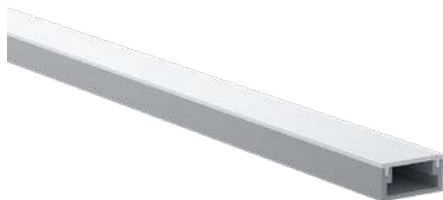

CODE	COLOR	SIZE	PRICE
83050	● Plata / Silver / Argent / Argento	2 m	9,95€
83051	○ Blanco / White / Blanc / Bianco	2 m	10,95€
83052	● Negro / Black / Noir / Nero	2 m	10,95€

Power
Max 30W/m

Material
AL 6063



IP
20

✂
Cutomised

Escala / Scale / Échelle / Scala 1:1

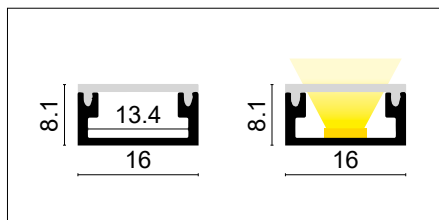

Difusor / Diffuser / Diffuseurs / Diffusore

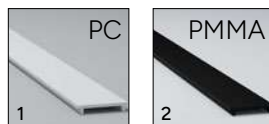

CODE	COLOR	SIZE	PRICE
83059-PN	● Opal / Opale	2 m	5,95€
83059-B	● Opal / Opale	2 m	5,95€
83065	● Opal / Opale	custom	3,95€

Tapas / Caps / Embout / Coperture

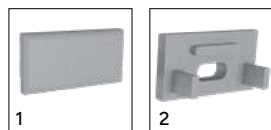

CODE 1	COLOR	PRICE
83054	● Plata / Silver / Argent / Argento	0,50€
83056	○ Blanco / White / Blanc / Bianco	0,50€
83058	● Negro / Black / Noir / Nero	0,50€

CODE 2

83053	● Plata / Silver / Argent / Argento	0,50€
83055	○ Blanco / White / Blanc / Bianco	0,50€
83057	● Negro / Black / Noir / Nero	0,50€

CODE

83063	● Negro / Black / Noir / Nero	2 m	6,95€
83066	● Negro / Black / Noir / Nero	custom	4,95€

Grapas / Staples / Agrafes / Graffete



CODE	COLOR	PRICE
83062	● Aluminio / Aluminium / Alluminio	0,80€

MONACO

Perfil de superficie / Surface profile / Profile de surface / Profilo di superficie



CODE	COLOR	SIZE	PRICE
85160	● Plata / Silver / Argent / Argento	2 m	11,95€
85195	● Plata / Silver / Argent / Argento	3 m*	17,95€
85165	○ Blanco / White / Blanc / Bianco	2 m	12,50€
85196	○ Blanco / White / Blanc / Bianco	3 m*	18,95€
85190	● Negro / Black / Noir / Nero	2 m	13,25€

Power
Max 30W/m

Material
AL 6063



IP
20

 Cutomised

Escala / Scale / Échelle / Scala 1:1

Difusor / Diffuser / Diffuseurs / Diffusore

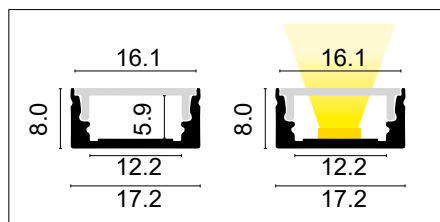

CODE	COLOR	SIZE	PRICE
85161	● Opal / Opale	2 m	6,95€
85193	● Negro / Black / Noir / Nero	2 m	13,95€
85198	● Opal / Opale	3 m	11,95€

Tapas / Caps / Embout / Copertura

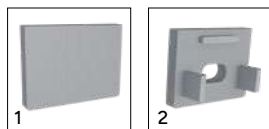

CODE 1	COLOR	PRICE
85162	● Plata / Silver / Argent / Argento	0,80€
85166	○ Blanco / White / Blanc / Bianco	0,99€
85191	● Negro / Black / Noir / Nero	0,99€

CODE 2	COLOR	PRICE
85163	● Plata / Silver / Argent / Argento	0,80€
85167	○ Blanco / White / Blanc / Bianco	0,99€
85192	● Negro / Black / Noir / Nero	0,99€

Grapas / Staples / Agrafes / Graffete



CODE	COLOR	PRICE
85164	● Aluminio / Aluminium / Alluminio	0,99€
85203	○ Plástico / Plastic / Plastique / Plastica	0,99€
85204	○ Plástico / Plastic / Plastique / Plastica 90°	1,45€

*Coste de envío a consultar en condiciones generales de venta. Shipping costs to be consulted in the general conditions of sale. Frais d'expédition à consulter dans les conditions générales de vente. Costi di spedizione da consultare nelle condizioni generali di vendita.

NAPOLES

Perfil de superficie / Surface profile / Profile de surface / Profilo di superfice



CODE	COLOR	SIZE	PRICE
83070	● Plata / Silver / Argent / Argento	2 m	11,95€
83071	○ Blanco / White / Blanc / Bianco	2 m	12,50€
83072	● Negro / Black / Noir / Nero	2 m	12,50€

Power Max 30W/m	Material AL 6063		IP 20	 Cutomised
--------------------	---------------------	---	-----------------	--

Escaleta / Scale / Échelle / Scala 1:1

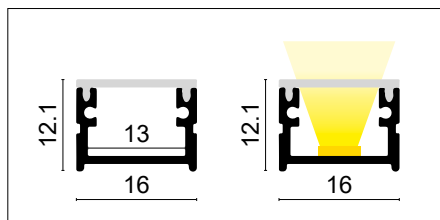

Difusor / Diffuser / Diffuseurs / Diffusore

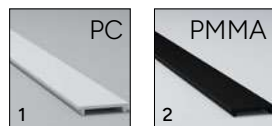

CODE	COLOR	SIZE	PRICE
83079-PN	● Opal / Opale	2 m	5,95€
83079-B	● Opal / Opale	2 m	5,95€
83085	● Opal / Opale	custom	3,95€

Tapas / Caps / Embout / Coperture

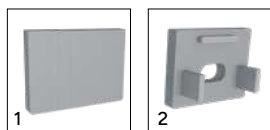

CODE 1	COLOR	PRICE
83074	● Plata / Silver / Argent / Argento	0,50€
83076	○ Blanco / White / Blanc / Bianco	0,50€
83078	● Negro / Black / Noir / Nero	0,50€

CODE 2

83073	● Plata / Silver / Argent / Argento	0,50€
83075	○ Blanco / White / Blanc / Bianco	0,50€
83077	● Negro / Black / Noir / Nero	0,50€

CODE

83083	● Negro / Black / Noir / Nero	2 m	6,95€
83086	● Negro / Black / Noir / Nero	custom	4,95€

Grapas / Staples / Agrafes / Graffete



CODE	COLOR	PRICE
83082	● Aluminio / Aluminium / Alluminio	0,80€

BAKU

Perfil de superficie / Surface profile / Profile de surface / Profilo di superficie



CODE	COLOR	SIZE	PRICE
83320	● Plata / Silver / Argent / Argento	2 m	19,95€
83321	○ Blanco / White / Blanc / Bianco	2 m	24,95€
83322	● Negro / Black / Noir / Nero	2 m	24,95€

Power Max 30W/m	Material AL 6063		IP 20	 Cutomised
--------------------	---------------------	---	-----------------	--

Escaleta / Scale / Échelle / Scala 1:1

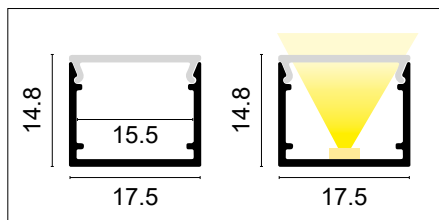

Difusor / Diffuser / Diffuseurs / Diffusore

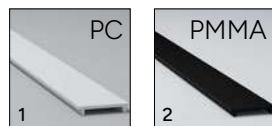

CODE	COLOR	SIZE	PRICE
83329	● Opal / Opale	2 m	7,95€
83335	● Opal / Opale	custom	4,95€

Tapas / Caps / Embout / Coperture

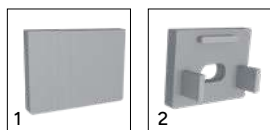

CODE 1	COLOR	PRICE
83324	● Plata / Silver / Argent / Argento	0,90€
83326	○ Blanco / White / Blanc / Bianco	0,90€
83328	● Negro / Black / Noir / Nero	0,90€

CODE 2	COLOR	PRICE
83323	● Plata / Silver / Argent / Argento	0,90€
83325	○ Blanco / White / Blanc / Bianco	0,90€
83327	● Negro / Black / Noir / Nero	0,90€

CODE	COLOR	PRICE
83332	● Negro / Black / Noir / Nero	2 m 11,95€
83336	● Negro / Black / Noir / Nero	custom 7,95€

Grapas / Staples / Agrafes / Graffete



CODE	COLOR	PRICE
83331	● Aluminio / Aluminium / Alluminio	0,95€

LIMA

Perfil de superficie / Surface profile / Profile de surface / Profilo di superficie



CODE	COLOR	SIZE	PRICE
83240	● Plata / Silver / Argent / Argento	2 m	10,95€
83241	○ Blanco / White / Blanc / Bianco	2 m	12,95€
83242	● Negro / Black / Noir / Nero	2 m	12,95€

Power
Max 30W/m

Material
AL 6063



IP
20

 Cutomised

Escaleta / Scale / Échelle / Scala 1:1

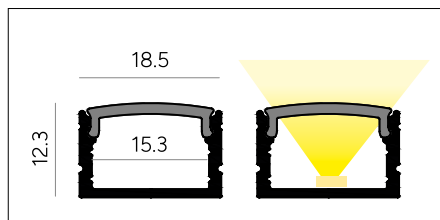

Difusor / Diffuser / Diffuseurs / Diffusore

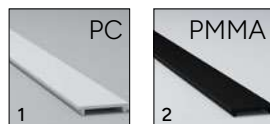

CODE	COLOR	SIZE	PRICE
83249	● Opal / Opale	2 m	5,95€
83250	● Opal / Opale	custom	3,95€

Tapas / Caps / Embout / Coperture

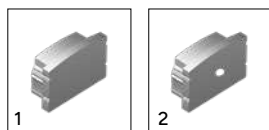

CODE 1	COLOR	PRICE
83244	● Plata / Silver / Argent / Argento	0,60€
83246	○ Blanco / White / Blanc / Bianco	0,60€
83248	● Negro / Black / Noir / Nero	0,60€

CODE 2

83243	● Plata / Silver / Argent / Argento	0,60€
83245	○ Blanco / White / Blanc / Bianco	0,60€
83247	● Negro / Black / Noir / Nero	0,60€

CODE

83251	● Negro / Black / Noir / Nero	2 m	6,95€
83252	● Negro / Black / Noir / Nero	custom	4,95€

Grapas / Staples / Agrafes / Graffete



CODE	COLOR	PRICE
83253	● Aluminio / Aluminium / Alluminio	0,60€

QUEBEC

Perfil de superficie / Surface profile / Profile de surface / Profilo di superficie



CODE	COLOR	SIZE	PRICE
83090	● Plata / Silver / Argent / Argento	2 m	14,95€
83091	○ Blanco / White / Blanc / Bianco	2 m	16,95€
83092	● Negro / Black / Noir / Nero	2 m	16,95€

Power
Max 30W/m

Material
AL 6063



IP
20

 Customised

Escaleta / Scale / Échelle / Scala 1:1

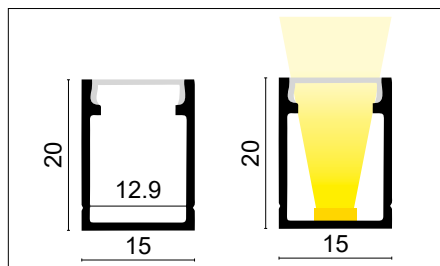

Difusor / Diffuser / Diffuseurs / Diffusore

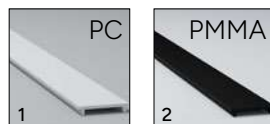

CODE 1	COLOR	SIZE	PRICE
83099	● Opal / Opale	2 m	6,95€
CODE 2			
83103	● Negro / Black / Noir / Nero	2 m	7,95€

Tapas / Caps / Embout / Coperture

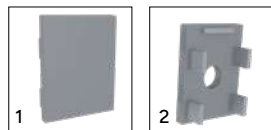

CODE 1	COLOR	PRICE
83094	● Plata / Silver / Argent / Argento	0,99€
83096	○ Blanco / White / Blanc / Bianco	0,99€
83098	● Negro / Black / Noir / Nero	0,99€
CODE 2		
83093	● Plata / Silver / Argent / Argento	0,99€
83095	○ Blanco / White / Blanc / Bianco	0,99€
83097	● Negro / Black / Noir / Nero	0,99€

Grapas / Staples / Agrafes / Graffette



CODE	COLOR	PRICE
83102	● Aluminio / Aluminium / Alluminio	0,99€

ARGEL

Perfil de superficie / Surface profile / Profile de surface / Profilo di superficie



CODE	COLOR	SIZE	PRICE
85290	● Plata / Silver / Argent / Argento	2 m	24,95€
85293	● Plata / Silver / Argent / Argento	3 m*	34,45€

Power
Max 30W/m

Material
AL 6063



IP
20

 Customised

Escala / Scale / Échelle / Scala 1:1

Difusor / Diffuser / Diffuseurs / Diffusore

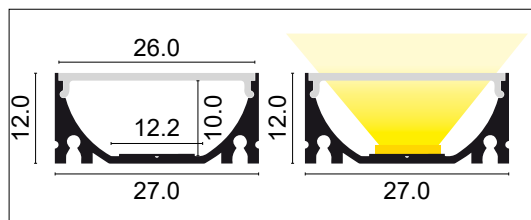

CODE	COLOR	SIZE	PRICE
85618	● Opal / Opale	2 m	7,95€
85619	● Opal / Opale	3 m	12,45€

Grapas / Staples / Agrafes / Graffete



CODE	COLOR	PRICE
85302	● Aluminio / Aluminium / Alluminio	1,15€

Tapas / Caps / Embout / Coperture

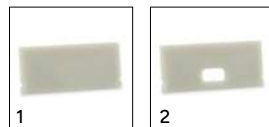

CODE 1	COLOR	PRICE
85297	● Plata / Silver / Argent / Argento	0,95€

CODE 2	COLOR	PRICE
85296	● Plata / Silver / Argent / Argento	0,95€

*Coste de envío a consultar en condiciones generales de venta. Shipping costs to be consulted in the general conditions of sale. Frais d'expédition à consulter dans les conditions générales de vente. Costi di spedizione da consultare nelle condizioni generali di vendita.

TURIA

Perfil de superficie / Surface profile / Profile de surface / Profilo di superficie



CODE	COLOR	SIZE	PRICE
85100	● Plata / Silver / Argent / Argento	3 m*	22,95€

Code 90040: Sellado IP65 para perfil estanco / IP65 sealing for watertight profile / Étanchéité IP65 pour profil étanche / Guarnizione IP65 per un profilo a tenuta stagna.

Power Max 30W/m	Material AL 6063		IP 20	 Cutomised
--------------------	---------------------	---	-----------------	---

Escala / Scale / Échelle / Scala 1:1

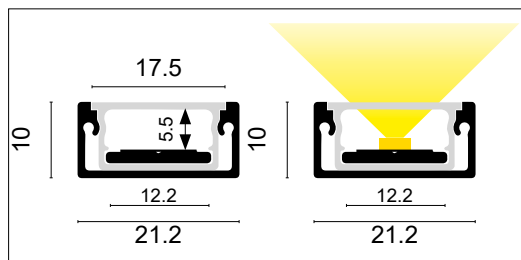

Pletina / Platen / Platine / Piastra a nastro



CODE	COLOR	SIZE	PRICE
85136	● Aluminio / Aluminium / Alluminio	3 m	10,95€

Grapas / Staples / Agrafes / Graffete



CODE	COLOR	PRICE
85103	● Aluminio / Aluminium / Alluminio	0,95€

Tapas / Caps / Embout / Coperture

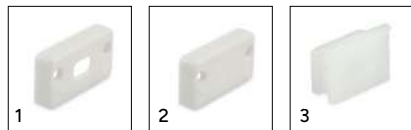

CODE 1	COLOR	PRICE
85101	● Gris / Grey / Grigio	0.50€

CODE 2	COLOR	PRICE
85102	● Gris / Grey / Grigio	0,50€

CODE 2	COLOR	PRICE
85108	○ Silicona / Silicone	1,95€

Difusor / Diffuser / Diffuseurs / Diffusore



CODE	COLOR	PRICE
85107	○ Opal / Opale	19,95€

*Coste de envío a consultar en condiciones generales de venta. Shipping costs to be consulted in the general conditions of sale. Frais d'expédition à consulter dans les conditions générales de vente. Costi di spedizione da consultare nelle condizioni generali di vendita.

TAJO

Perfil de superficie / Surface profile / Profile de surface / Profilo di superficie



CODE	COLOR	SIZE	PRICE
85120	● Plata / Silver / Argent / Argento	3 m*	24,95€

Code 90040: Sellado IP65 para perfil estanco / IP65 sealing for watertight profile / Étanchéité IP65 pour profil étanche / Guarnizione IP65 per un profilo a tenuta stagna.

Power
Max 30W/m

Material
AL 6063



IP
20

 Cutomised

Escala / Scale / Échelle / Scala 1:1

Pletina / Platen / Platine / Piastra a nastro

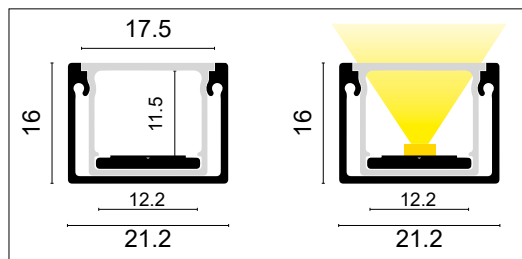

CODE	COLOR	SIZE	PRICE
85136	● Aluminio / Aluminium / Alluminio	3 m	10,95€

Tapas / Caps / Embout / Coperture



CODE 1	COLOR	PRICE
85121	● Gris / Grey / Grigio	0,50€

CODE 2	COLOR	PRICE
85122	● Gris / Grey / Grigio	0,50€

CODE 2	COLOR	PRICE
85128	○ Silicona / Silicone	1,95€

Grapas / Staples / Agrafes / Graffete



CODE	COLOR	PRICE
85123	● Aluminio / Aluminium / Alluminio	0,95€

Difusor / Diffuser / Diffuseurs / Diffusore



CODE	COLOR	PRICE
85127	○ Opal / Opale	44,95€

*Coste de envío a consultar en condiciones generales de venta. Shipping costs to be consulted in the general conditions of sale. Frais d'expédition à consulter dans les conditions générales de vente. Costi di spedizione da consultare nelle condizioni generali di vendita.

pletinas

Platen / Platine / Piastra a nastro



ES_ Nuestras pletinas para perfilera LED son el soporte ideal para garantizar instalaciones seguras, estéticas y funcionales. Diseñadas con materiales de alta calidad, ofrecen máxima resistencia y un acabado impecable, adaptándose a cualquier diseño arquitectónico o decorativo.

EN_ Our LED profile plates are the ideal support for ensuring safe, aesthetic, and functional installations. Designed with high-quality materials, they offer maximum durability and a flawless finish, adapting to any architectural or decorative design.

FR_ Nos platines pour profilés LED sont le support idéal pour garantir des installations sûres, esthétiques et fonctionnelles. Conçues avec des matériaux de haute qualité, elles offrent une résistance maximale et une finition impeccable, s'adaptant à tout design architectural ou décoratif.

IT_ Le nostre piastrine per profili LED sono il supporto ideale per garantire installazioni sicure, estetiche e funzionali. Progettate con materiali di alta qualità, offrono la massima resistenza e una finitura impecabile, adattandosi a qualsiasi design architettonico o decorativo.

Pletina / Platen / Platine / Piastra a nastro

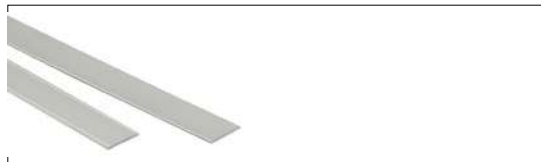

CODE	COLOR	SIZE	MM	PRICE
83535	● Aluminio / Aluminium / Alluminio	2 m	6,8 mm	5,95€

Pletina / Platen / Platine / Piastra a nastro



CODE	COLOR	SIZE	MM	PRICE
83536	● Aluminio / Aluminium / Alluminio	2 m	10 mm	6,95€

Pletina / Platen / Platine / Piastra a nastro

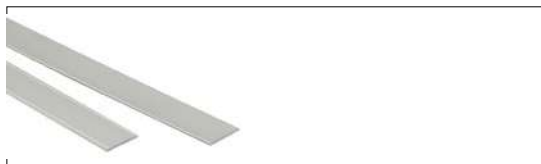

CODE	COLOR	SIZE	MM	PRICE
83534	● Aluminio / Aluminium / Alluminio	2 m	13 mm	7,95€

Pletina / Platen / Platine / Piastra a nastro



CODE	COLOR	SIZE	MM	PRICE
85136	● Aluminio / Aluminium / Alluminio	3 m*	13,6 mm	10,95€

*Coste de envío a consultar en condiciones generales de venta. Shipping costs to be consulted in the general conditions of sale. Frais d'expédition à consulter dans les conditions générales de vente. Costi di spedizione da consultare nelle condizioni generali di vendita.

perfilería de superficie-suspensión



Perfilería de superficie suspensión

ES_ Descubre nuestra perfilería de suspensión, diseñada para ofrecer iluminación elegante y funcional. Ideal para espacios modernos.

Suspension surface profiling

EN_ Discover our suspension profiles, designed to deliver elegant and functional lighting. Perfect for modern spaces.



Profil de la surface de suspension

FR_ Découvrez nos profilés de suspension, conçus pour offrir un éclairage élégant et fonctionnel. Parfaits pour les espaces modernes.

Profili della superficie di sospensione

IT_ Scopri i nostri profili a sospensione, progettati per offrire un'illuminazione elegante e funzionale. Perfetti per spazi moderni.



CANTÓN

Superficie-Suspensión / Surface-suspension / Superficie-sospensione



CODE	COLOR	SIZE	PRICE
83670	● Plata / Silver / Argent / Argento	2 m	42,95€
83671	○ Blanco / White / Blanc / Bianco	2 m	52,65€
83672	● Negro / Black / Noir / Nero	2 m	52,65€

Power
Max 100W/m

Material
AL 6063



IP
20

Customised

Escala / Scale / Échelle / Scala 1:1

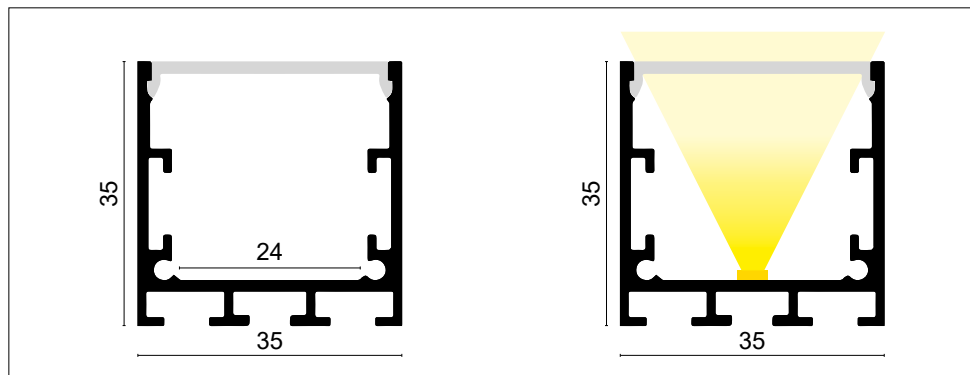

Suspensión / Suspension / Sospensione



CODE	SIZE	PRICE
88021	1.000 mm	14,95€
88022	1.250 mm	15,95€
88023	1.500 mm	16,95€
88024	2.000 mm	17,95€
88025	3.000 mm	19,95€
88026	4.000 mm	21,95€
88027	5.000 mm	23,95€

Tapas / Caps / Embout / Coperture

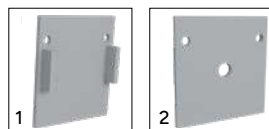

CODE 1	COLOR	PRICE
83674	● Plata / Silver / Argent / Argento	1,85€
83676	○ Blanco / White / Blanc / Bianco	1,85€
83678	● Negro / Black / Noir / Nero	1,85€

CODE 2	COLOR	PRICE
83673	● Plata / Silver / Argent / Argento	1,85€
83675	○ Blanco / White / Blanc / Bianco	1,85€
83677	● Negro / Black / Noir / Nero	1,85€

Conector / Connector / Connecteur / Connettore



CODE 1	COLOR	PRICE
85027	● Aluminio / Aluminium / Alluminio	2,95€
85028	● Aluminio / Aluminium / Alluminio	3,25€
85029	● Aluminio / Aluminium / Alluminio	3,25€
85030	● Aluminio / Aluminium / Alluminio	3,25€

Difusor / Diffuser / Diffuseurs / Diffusore

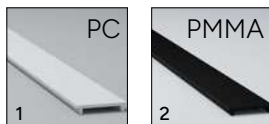

CODE 1	COLOR	SIZE	PRICE
83679	● Opal / Opale	2 m	9,95€
83685	● Opal / Opale	custom	5,95€

CODE 2	COLOR	SIZE	PRICE
83680	● Negro / Black / Noir / Nero	2 m	13,95€
83686	● Negro / Black / Noir / Nero	custom	7,95€

VICTORIA

Superficie-Suspensión / Surface-suspension / Superficie-sospensione



CODE	COLOR	SIZE	PRICE
83690	● Plata / Silver / Argent / Argento	2 m	59,95€
83691	○ Blanco / White / Blanc / Bianco	2 m	64,45€
83692	● Negro / Black / Noir / Nero	2 m	64,45€

Power
Max 100W/m

Material
AL 6063



IP
20

Customised

Escala / Scale / Échelle / Scala 1:1

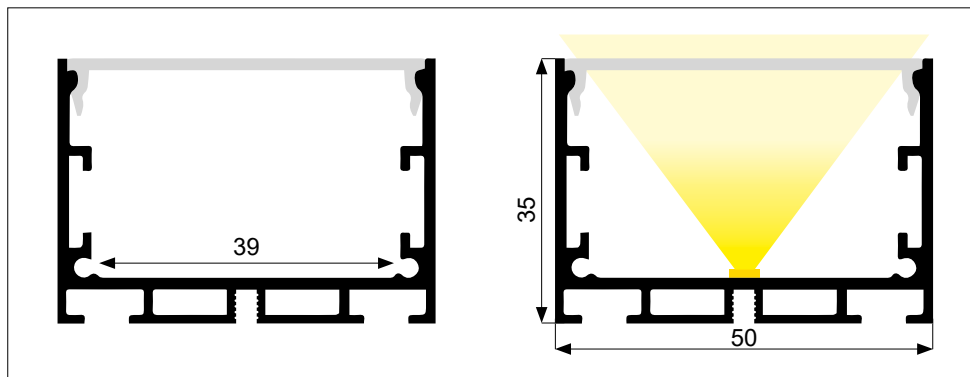

Suspensión / Suspension / Sospensione



CODE	SIZE	PRICE
83703	1.000 mm	14,95€
83724	1.250 mm	15,95€
83725	1.500 mm	16,95€
83726	2.000 mm	18,95€
83727	3.000 mm	22,95€
83728	4.000 mm	26,95€
83729	5.000 mm	29,95€

Tapas / Caps / Embout / Coperture

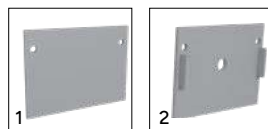

CODE 1	COLOR	PRICE
83694	● Plata / Silver / Argent / Argento	1,85€
83696	○ Blanco / White / Blanc / Bianco	1,85€
83698	● Negro / Black / Noir / Nero	1,85€

CODE 2	COLOR	PRICE
83693	● Plata / Silver / Argent / Argento	1,85€
83695	○ Blanco / White / Blanc / Bianco	1,85€
83697	● Negro / Black / Noir / Nero	1,85€

Conector / Connector / Connecteur / Connettore



CODE 1	COLOR	PRICE
85027	● Aluminio / Aluminium / Alluminio	2,95€
85028	● Aluminio / Aluminium / Alluminio	3,25€
85029	● Aluminio / Aluminium / Alluminio	3,25€
85030	● Aluminio / Aluminium / Alluminio	3,25€

Difusor / Diffuser / Diffuseurs / Diffusore

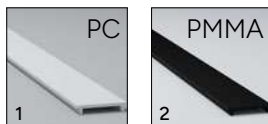

CODE 1	COLOR	SIZE	PRICE
83699	● Opal / Opale	2 m	12,85€
83705	● Opal / Opale	custom	7,95€

CODE 2	COLOR	SIZE	PRICE
83700	● Negro / Black / Noir / Nero	2 m	16,10€
83706	● Negro / Black / Noir / Nero	custom	9,95€

LYON

Superficie-Suspensión / Surface-suspension / Superficie-sospensione



CODE	COLOR	SIZE	PRICE
83110	● Plata / Silver / Argent / Argento	2 m	14,95€
83111	○ Blanco / White / Blanc / Bianco	2 m	16,95€
83112	● Negro / Black / Noir / Nero	2 m	16,95€

Power
Max 30W/m

Material
AL 6063



IP
20

 Customised

Escala / Scale / Échelle / Scala 1:1

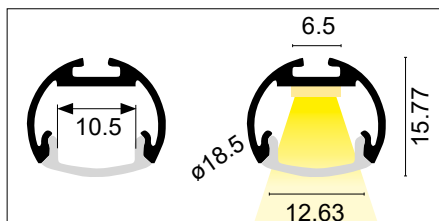

Difusor / Diffuser / Diffuseurs / Diffusore

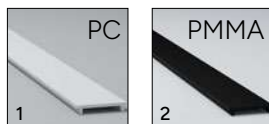

CODE 1	COLOR	SIZE	PRICE
83119	● Opal / Opale	2 m	5,95€

CODE 2

83126	● Negro / Black / Noir / Nero	2 m	7,95€
-------	-------------------------------	-----	-------

Tapas / Caps / Embout / Coperture

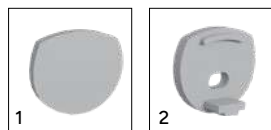

CODE 1	COLOR	PRICE
83114	● Plata / Silver / Argent / Argento	0,50€
83116	○ Blanco / White / Blanc / Bianco	0,50€
83118	● Negro / Black / Noir / Nero	0,50€

CODE 2

83113	● Plata / Silver / Argent / Argento	0,50€
83115	○ Blanco / White / Blanc / Bianco	0,50€
83117	● Negro / Black / Noir / Nero	0,50€

Suspensión / Suspension / Sospensione



CODE	SIZE	PRICE
83127	1.000 mm	15,95€

TURIN

Superficie-Suspensión / Surface-suspension / Superficie-sospensione



CODE	COLOR	SIZE	PRICE
83650	● Plata / Silver / Argent / Argento	2 m	19,30€
83651	○ Blanco / White / Blanc / Bianco	2 m	21,45€
83652	● Negro / Black / Noir / Nero	2 m	21,45€

Power
Max 30W/m

Material
AL 6063



IP
20

 Customised

Escala / Scale / Échelle / Scala 1:1

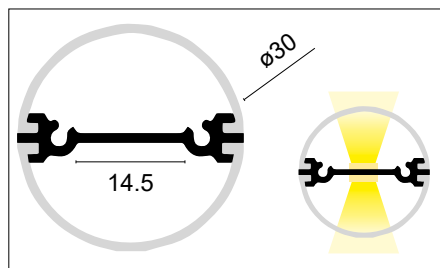

Difusor / Diffuser / Diffuseurs / Diffusore

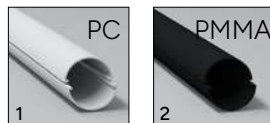

CODE 1	COLOR	SIZE	PRICE
83659	● Opal / Opale	2 m	16,95€
CODE 2			
83660	● Negro / Black / Noir / Nero	2 m	19,95€

Tapas / Caps / Embout / Coperture

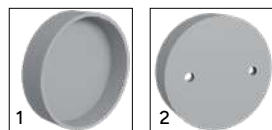

CODE 1	COLOR	PRICE
83654	● Plata / Silver / Argent / Argento	1,85€
83656	○ Blanco / White / Blanc / Bianco	1,85€
83658	● Negro / Black / Noir / Nero	1,85€
CODE 2		
83653	● Plata / Silver / Argent / Argento	1,85€
83655	○ Blanco / White / Blanc / Bianco	1,85€
83657	● Negro / Black / Noir / Nero	1,85€

Suspensión / Suspension / Sospensione



CODE	SIZE	PRICE
88030	1.000 mm	12,95€
88031	1.250 mm	13,95€
88032	1.500 mm	14,95€
88033	2.000 mm	15,95€
88034	3.000 mm	17,95€
88035	4.000 mm	18,95€
88036	5.000 mm	19,95€

RIGA

Superficie-Suspensión / Surface-suspension / Superficie-sospensione



CODE	COLOR	SIZE	PRICE
85020	● Plata / Silver / Argent / Argento	2 m	15,95€

Power
Max 30W/m

Material
AL 6063



IP
20

 Customised

Escala / Scale / Échelle / Scala 1:1

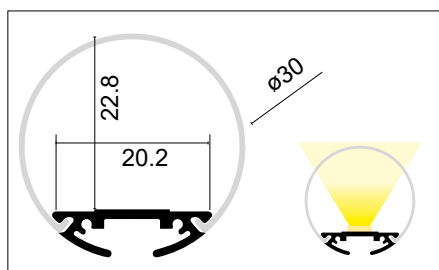

Suspensión / Suspension / Sospensione



Regulación superior

CODE	SIZE	PRICE
85024	2.000 mm	29,95€



Regulación inferior

CODE	SIZE	PRICE
85025	2.000 mm	29,95€

Conector / Connector / Connecteur / Connettore



CODE 1	COLOR	PRICE
85027	● Aluminio / Aluminium / Alluminio	2,95€
85028	● Aluminio / Aluminium / Alluminio	3,25€
85029	● Aluminio / Aluminium / Alluminio	3,25€
85030	● Aluminio / Aluminium / Alluminio	3,25€

Tapas / Caps / Embout / Coperture



CODE 1	COLOR	PRICE
85022	● Gris / Grey / Grigio	2,95€

CODE 2	COLOR	PRICE
85023	● Gris / Grey / Grigio	2,95€

Grapas / Staples / Agrafes / Graffete

CODE	COLOR	PRICE
85026	● Aluminio / Aluminium / Alluminio	2,25€

Difusor / Diffuser / Diffuseurs / Diffusore

CODE	COLOR	PRICE
85021	● Opal / Opale	19,95€



perfilería angular



Perfilería angular

ES_ Nuestra perfilería angular ofrece soluciones versátiles para iluminar rincones y esquinas con precisión y estilo. Perfecta para realzar diseños modernos y optimizar el uso del espacio.

Profiling angular

EN_ Our angular profiles provide versatile solutions to illuminate corners and edges with precision and style. Perfect for enhancing modern designs and optimizing space usage.



Profilage angulaire

FR_ Nos profilés angulaires offrent des solutions polyvalentes pour illuminer les coins et les angles avec précision et élégance. Parfaits pour sublimer les designs modernes et optimiser l'espace.

Profilazione angolare

IT_ I nostri profili angolari offrono soluzioni versatili per illuminare angoli e spigoli con precisione e stile. Perfetti per valorizzare i design moderni e ottimizzare l'uso dello spazio.



LAGOS

Perfil angular / Angle profile / Profilé d'angle / Profilo angolare



CODE	COLOR	SIZE	PRICE
85310	● Plata / Silver / Argent / Argento	2 m	9,95€

Power
Max 30W/m

Material
AL 6063



IP
20

 Customised

Escala / Scale / Échelle / Scala 1:1

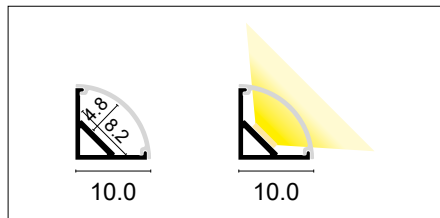

Tapas / Caps / Embout / Coperture

Difusor / Diffuser / Diffuseurs / Diffusore

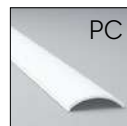

CODE	COLOR	PRICE
85312	● Gris / Grey / Grigio	1,10€

CODE	COLOR	PRICE
85311	○ Opal / Opale	8,95€

GLASGOW

Perfil angular / Angle profile / Profilé d'angle / Profilo angolare



CODE	COLOR	SIZE	PRICE
83190	● Plata / Silver / Argent / Argento	2 m	10,95€
83191	○ Blanco / White / Blanc / Bianco	2 m	12,95€
83192	● Negro / Black / Noir / Nero	2 m	12,95€

Power
Max 30W/m

Material
AL 6063



IP
20

✂
Customised

Escala / Scale / Échelle / Scala 1:1

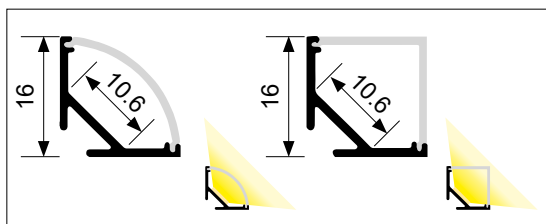

Tapas / Caps / Embout / Coperture



CODE 1	COLOR	PRICE
83194	● Plata / Silver / Argent / Argento	0,80€
83196	○ Blanco / White / Blanc / Bianco	0,80€
83198	● Negro / Black / Noir / Nero	0,80€

Difusor / Diffuser / Diffuseurs / Diffusore



CODE	COLOR	SIZE	PRICE
83205	○ Opal / Opale	2 m	7,95€
83215	○ Opal / Opale	custom	4,95€



CODE	COLOR	SIZE	PRICE
83208	○ Opal / Opale	2 m	8,95€



CODE	COLOR	SIZE	PRICE
83212	● Negro / Black / Noir / Nero	2 m	8,95€
83216	● Negro / Black / Noir / Nero	custom	5,95€



CODE	COLOR	SIZE	PRICE
83213	● Negro / Black / Noir / Nero	2 m	9,95€

Grapas / Staples / Agrafes / Graffete



CODE	COLOR	PRICE
83211	● Aluminio / Aluminium / Alluminio	0,80€

CODE 2	COLOR	PRICE
83200	● Plata / Silver / Argent / Argento	0,80€
83202	○ Blanco / White / Blanc / Bianco	0,80€
83204	● Negro / Black / Noir / Nero	0,80€



CODE 3	COLOR	PRICE
83193	● Plata / Silver / Argent / Argento	0,80€
83195	○ Blanco / White / Blanc / Bianco	0,80€
83197	● Negro / Black / Noir / Nero	0,80€

CODE 4	COLOR	PRICE
83199	● Plata / Silver / Argent / Argento	0,80€
83201	○ Blanco / White / Blanc / Bianco	0,80€
83203	● Negro / Black / Noir / Nero	0,80€

ROMA

Perfil angular / Angle profile / Profilé d'angle / Profilo angolare



CODE	COLOR	SIZE	PRICE
85170	● Plata / Silver / Argent / Argento	2 m	10,95€
85177	● Plata / Silver / Argent / Argento	3 m*	16,45€

Power
Max 30W/m

Material
AL 6063



IP
20

 Customised

Escala / Scale / Échelle / Scala 1:1

Difusor / Diffuser / Diffuseurs / Diffusore

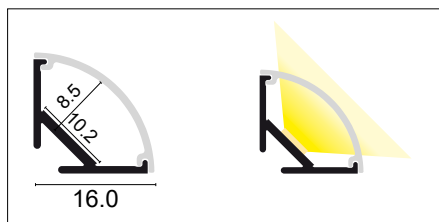

CODE	COLOR	SIZE	PRICE
85171	○ Opal / Opale	2 m	10,95€
85178	○ Opal / Opale	3 m	15,95€

Tapas / Caps / Embout / Copertura

Grapas / Staples / Agrafes / Graffette



CODE 1	COLOR	PRICE
85172	● Plata / Silver / Argent / Argento	1,10€
CODE 2		
85173	● Plata / Silver / Argent / Argento	1,10€



CODE 1	COLOR	PRICE
85174	● Aluminio / Aluminium / Alluminio	1,15€
CODE 2		
85175	○ Plástico / Plastic / Plastique / Plastica	1,45€
CODE 3		
85204	○ Plástico / Plastic / Plastique / Plastica 90°	1,45€

*Coste de envío a consultar en condiciones generales de venta. Shipping costs to be consulted in the general conditions of sale. Frais d'expédition à consulter dans les conditions générales de vente. Costi di spedizione da consultare nelle condizioni generali di vendita.

LEEDS

Perfil angular / Angle profile / Profilé d'angle / Profilo angolare



CODE	COLOR	SIZE	PRICE
85320	● Plata / Silver / Argent / Argento	2 m	28,95€
85321	● Plata / Silver / Argent / Argento	3 m*	43,95€

Power
Max 30W/m

Material
AL 6063



IP
20

✂ Customised

Escala / Scale / Échelle / Scala 1:1

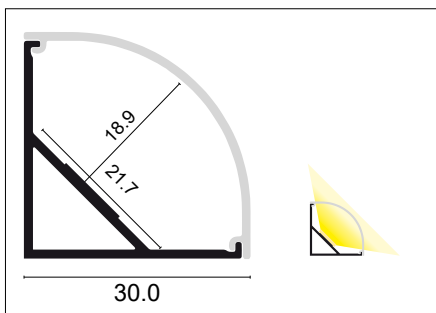

Tapas / Caps / Embout / Coperture



CODE 1	COLOR	PRICE
85327	● Plata / Silver / Argent / Argento	1,35€
CODE 2	COLOR	PRICE
85329	● Plata / Silver / Argent / Argento	1,35€

Difusor / Diffuser / Diffuseurs / Diffusore

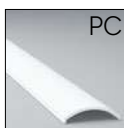

CODE	COLOR	SIZE	PRICE
85628	○ Opal / Opale	2 m	24,95€
85629	○ Opal / Opale	3 m	35,95€

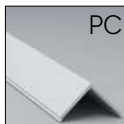

85630	○ Opal / Opale	2 m	21,95€
85631	○ Opal / Opale	3 m	34,95€



CODE 3	COLOR	PRICE
85326	● Plata / Silver / Argent / Argento	1,35€
CODE 4	COLOR	PRICE
85328	● Plata / Silver / Argent / Argento	1,35€

Grapas / Staples / Agrafes / Graffete



CODE	COLOR	PRICE
85333	● Aluminio / Aluminium / Alluminio	1,35€



CODE	COLOR	PRICE
85334	○ Plástico / Plastic / Plastique / Plastica	0,99€

*Coste de envío a consultar en condiciones generales de venta. Shipping costs to be consulted in the general conditions of sale. Frais d'expédition à consulter dans les conditions générales de vente. Costi di spedizione da consultare nelle condizioni generali di vendita.

MONTREAL

Perfil angular / Angle profile / Profilé d'angle / Profilo angolare



CODE	COLOR	SIZE	PRICE
83220	● Plata / Silver / Argent / Argento	2 m	22,95€

Power
Max 30W/m

Material
AL 6063



IP
20

 Customised

Escala / Scale / Échelle / Scala 1:1

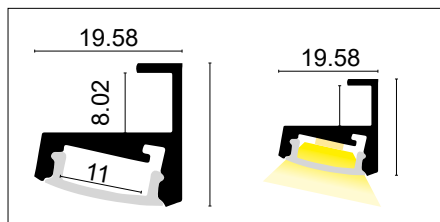

Difusor / Diffuser / Diffuseurs / Diffusore



CODE	COLOR	SIZE	PRICE
83229	● Opal / Opale	2 m	4,95€

Tapas / Caps / Embout / Coperture



CODE 1	COLOR	PRICE
83224	● Plata / Silver / Argent / Argento	0,80€

CODE 2	COLOR	PRICE
83223	● Plata / Silver / Argent / Argento	0,80€

Ejemplo / Example / Exemple / Esempio



RECIFE

Perfil angular / Angle profile / Profilé d'angle / Profilo angolare



CODE	COLOR	SIZE	PRICE
83640	● Plata / Silver / Argent / Argento	2 m	10,70€
83641	○ Blanco / White / Blanc / Bianco	2 m	12,85€
83642	● Negro / Black / Noir / Nero	2 m	12,85€

Power
Max 30W/m

Material
AL 6063



IP
20

Customised

Escala / Scale / Échelle / Scala 1:1

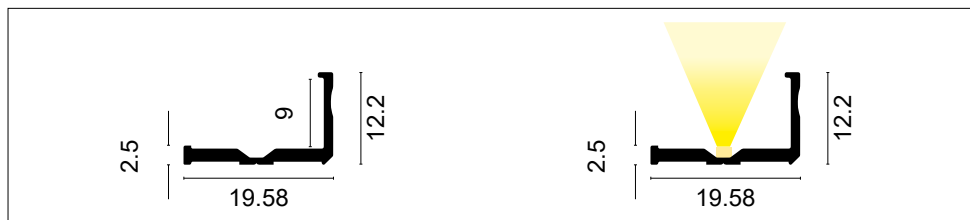

Ejemplo / Example / Exemple / Esempio



perfilería de empotrar



Perfil de empotrar

ES_ La perfilería de empotrar es la solución ideal para una iluminación discreta y sofisticada. Diseñada para integrarse perfectamente en cualquier superficie, aporta elegancia y funcionalidad a tus espacios.



Recessed profile

EN_ Recessed profiles are the ideal solution for discreet and sophisticated lighting. Designed to seamlessly integrate into any surface, they bring elegance and functionality to your spaces.



Profilé encastré

FR_ Les profilés encastrables sont la solution idéale pour un éclairage discret et sophistiqué. Conçus pour s'intégrer parfaitement à toutes les surfaces, ils apportent élégance et fonctionnalité à vos espaces.

Profilo de incasso

IT_ I profili ad incasso sono la soluzione ideale per un'illuminazione discreta e sofisticata. Progettati per integrarsi perfettamente su qualsiasi superficie, offrono eleganza e funzionalità ai tuoi spazi.



Image: Perfil de empotrar negro Dakar y tira Texas 230V

BURDEOS

Perfil empotrar / Recessed profile / Profilé encastré / Profilo incasso



CODE	COLOR	SIZE	PRICE
83260	● Plata / Silver / Argent / Argento	2 m	12,85€
83261	○ Blanco / White / Blanc / Bianco	2 m	16,10€
83262	● Negro / Black / Noir / Nero	2 m	16,10€

Power
Max 30W/m

Material
AL 6063



IP
20

 Customised

Escala / Scale / Échelle / Scala 1:1

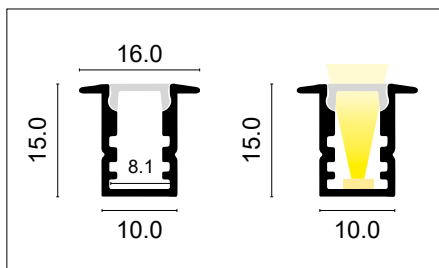

Difusor / Diffuser / Diffuseurs / Diffusore

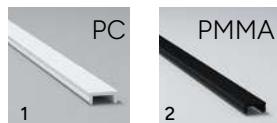

CODE 1	COLOR	SIZE	PRICE
83269	● Opal / Opale	2 m	4,95€
CODE 2			
83273	● Negro / Black / Noir / Nero	2 m	7,95€

Tapas / Caps / Embout / Coperture

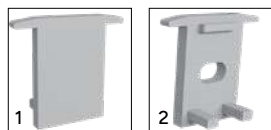

CODE 1	COLOR	PRICE
83264	● Plata / Silver / Argent / Argento	0,65€
83266	○ Blanco / White / Blanc / Bianco	0,65€
83268	● Negro / Black / Noir / Nero custom	0,65€
CODE 2		
83263	● Plata / Silver / Argent / Argento	0,65€
83265	○ Blanco / White / Blanc / Bianco	0,65€
83267	● Negro / Black / Noir / Nero custom	0,65€

Grapas / Staples / Agrafes / Graffete



CODE	SIZE	PRICE
83272	● Aluminio / Aluminium / Alluminio	0,80€

HANOI

Perfil empotrar / Recessed profile / Profilé encastré / Profilo incasso



CODE	COLOR	SIZE	PRICE
85340	● Plata / Silver / Argent / Argento	2 m	7,95€
85341	● Plata / Silver / Argent / Argento	3 m*	11,95€

Power
Max 30W/m

Material
AL 6063



IP
20

 Customised

Escala / Scale / Échelle / Scala 1:1

Difusor / Diffuser / Diffuseurs / Diffusore

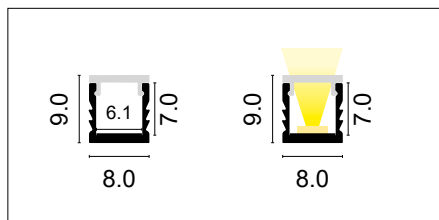

CODE	COLOR	SIZE	PRICE
85606	● Opal / Opale	2 m	7,95€
85607	● Opal / Opale	3 m*	11,95€

Tapas / Caps / Embout / Coperture



CODE	COLOR	PRICE
85245	● Plata / Silver / Argent / Argento	1,35€

*Coste de envío a consultar en condiciones generales de venta. Shipping costs to be consulted in the general conditions of sale. Frais d'expédition à consulter dans les conditions générales de vente. Costi di spedizione da consultare nelle condizioni generali di vendita.

KUWAIT

Perfil empotrar / Recessed profile / Profilé encastré / Profilo incasso



CODE	COLOR	SIZE	PRICE
83150	● Plata / Silver / Argent / Argento	2 m	9,95€
83151	○ Blanco / White / Blanc / Bianco	2 m	12,95€
83152	● Negro / Black / Noir / Nero	2 m	12,95€

Power
Max 30W/m

Material
AL 6063



IP
20

 Cutomised

Escala / Scale / Échelle / Scala 1:1

Difusor / Diffuser / Diffuseurs / Diffusore

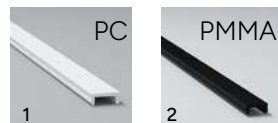
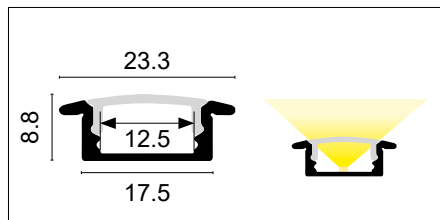

CODE 1	COLOR	SIZE	PRICE
83159	● Opal / Opale	2 m	5,95€
83165	● Opal / Opale	custom	3,95€

CODE 2

83163	● Negro / Black / Noir / Nero	2 m	6,95€
83166	● Negro / Black / Noir / Nero	custom	4,95€

Tapas / Caps / Embout / Coperture



CODE 1	COLOR	PRICE
83154	● Plata / Silver / Argent / Argento	0,65€
83156	○ Blanco / White / Blanc / Bianco	0,65€
83158	● Negro / Black / Noir / Nero	custom 0,65€

CODE 2

83153	● Plata / Silver / Argent / Argento	0,65€
83155	○ Blanco / White / Blanc / Bianco	0,65€
83157	● Negro / Black / Noir / Nero	custom 0,65€

Grapas / Staples / Agrafes / Graffete



CODE	SIZE	PRICE
83162	● Aluminio / Aluminium / Alluminio	0,99€

TALLIN

Perfil empotrar / Recessed profile / Profilé encastré / Profilo incasso



CODE	COLOR	SIZE	PRICE
83340	● Plata / Silver / Argent / Argento	2 m	23,95€
83341	○ Blanco / White / Blanc / Bianco	2 m	29,95€
83342	● Negro / Black / Noir / Nero	2 m	29,95€

Power
Max 30W/m

Material
AL 6063



IP
20

 Customised

Escala / Scale / Échelle / Scala 1:1

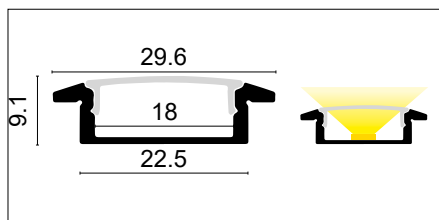

Difusor / Diffuser / Diffuseurs / Diffusore

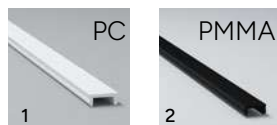

CODE 1	COLOR	SIZE	PRICE
83349	● Opal / Opale	2 m	9,25€
83355	● Opal / Opale	custom	5,95€

CODE 2

83352	● Negro / Black / Noir / Nero	2 m	13,95€
83356	● Negro / Black / Noir / Nero	custom	8,95€

Tapas / Caps / Embout / Coperture



CODE 1	COLOR	PRICE
83344	● Plata / Silver / Argent / Argento	0,85€
83346	○ Blanco / White / Blanc / Bianco	0,85€
83348	● Negro / Black / Noir / Nero	0,85€

CODE 2

83343	● Plata / Silver / Argent / Argento	0,85€
83345	○ Blanco / White / Blanc / Bianco	0,85€
83347	● Negro / Black / Noir / Nero	0,85€

Grapas / Staples / Agrafes / Graffete



CODE	SIZE	PRICE
83351	● Aluminio / Aluminium / Alluminio	0,85€

DAKAR

Perfil empotrar / Recessed profile / Profilé encastré / Profilo incasso



CODE	COLOR	SIZE	PRICE
83130	● Plata / Silver / Argent / Argento	2 m	17,95€
83131	○ Blanco / White / Blanc / Bianco	2 m	19,95€
83132	● Negro / Black / Noir / Nero	2 m	19,95€

Power
Max 30W/m

Material
AL 6063



IP
20

 Cutomised

Escala / Scale / Échelle / Scala 1:1

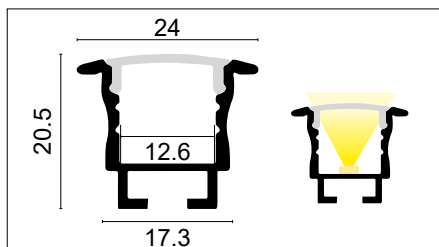

Difusor / Diffuser / Diffuseurs / Diffusore

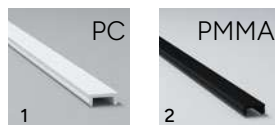

CODE 1	COLOR	SIZE	PRICE
83139	● Opal / Opale	2 m	5,95€
83145	● Opal / Opale	custom	3,95€

CODE 2	COLOR	SIZE	PRICE
83143	● Negro / Black / Noir / Nero	2 m	6,95€
83146	● Negro / Black / Noir / Nero	custom	5,95€

Tapas / Caps / Embout / Coperture

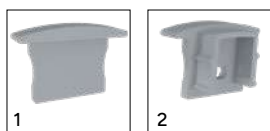

CODE 1	COLOR	PRICE
83134	● Plata / Silver / Argent / Argento	0,80€
83136	○ Blanco / White / Blanc / Bianco	0,80€
83138	● Negro / Black / Noir / Nero	0,80€

CODE 2	COLOR	PRICE
83133	● Plata / Silver / Argent / Argento	0,80€
83135	○ Blanco / White / Blanc / Bianco	0,80€
83137	● Negro / Black / Noir / Nero	0,80€

Grapas / Staples / Agrafes / Graffete



CODE	SIZE	PRICE
83142	● Aluminio / Aluminium / Alluminio	3,95€

LIMA

Perfil empotrar / Recessed profile / Profilé encastré / Profilo incasso



CODE	COLOR	SIZE	PRICE
83750	● Plata / Silver / Argent / Argento	2 m	11,95€
83751	○ Blanco / White / Blanc / Bianco	2 m	13,95€
83752	● Negro / Black / Noir / Nero	2 m	13,95€

Power
Max 30W/m

Material
AL 6063



IP
20

✂
Cutomised

Escala / Scale / Échelle / Scala 1:1

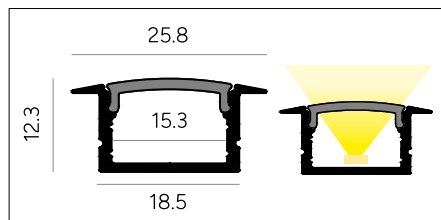

Difusor / Diffuser / Diffuseurs / Diffusore

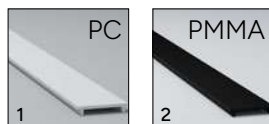

CODE	COLOR	SIZE	PRICE
83249	● Opal / Opale	2 m	5,95€
83250	● Opal / Opale	custom	3,95€

Tapas / Caps / Embout / Coperture

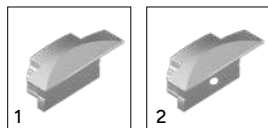

CODE 1	COLOR	PRICE
83754	● Plata / Silver / Argent / Argento	0,60€
83756	○ Blanco / White / Blanc / Bianco	0,60€
83758	● Negro / Black / Noir / Nero	0,60€

CODE 2

83753	● Plata / Silver / Argent / Argento	0,60€
83755	○ Blanco / White / Blanc / Bianco	0,60€
83757	● Negro / Black / Noir / Nero	0,60€

CODE

83251	● Negro / Black / Noir / Nero	2 m	6,95€
83252	● Negro / Black / Noir / Nero	custom	4,95€

Grapas / Staples / Agrafes / Graftete



CODE	COLOR	PRICE
83763	● Aluminio / Aluminium / Alluminio	0,60€

MONTERREY

Perfil empotrar / Recessed profile / Profilé encastré / Profilo incasso



CODE	COLOR	SIZE	PRICE
85370	● Plata / Silver / Argent / Argento	2 m	26,95€
85371	○ Blanco / White / Blanc / Bianco	2 m	29,95€
85372	● Negro / Black / Noir / Nero	2 m	29,95€

Power
Max 30W/m

Material
AL 6063



IP
20

 Customised

Escala / Scale / Échelle / Scala 1:1

Difusor / Diffuser / Diffuseurs / Diffusore

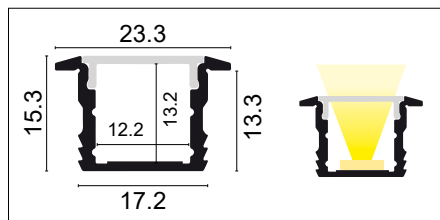

CODE	COLOR	SIZE	PRICE
85161	● Opal / Opale	2 m	6,95€
85612	● Negro / Black / Noir / Nero	2 m	12,95€

Tapas / Caps / Embout / Coperture



CODE 1	COLOR	PRICE
85377	● Plata / Silver / Argent / Argento	0,95€
85379	○ Blanco / White / Blanc / Bianco	0,95€
85381	● Negro / Black / Noir / Nero	0,95€

CODE 2	COLOR	PRICE
85376	● Plata / Silver / Argent / Argento	0,95€
85378	○ Blanco / White / Blanc / Bianco	0,95€
85380	● Negro / Black / Noir / Nero	0,95€

HARBIN

Perfil empotrar / Recessed profile / Profilé encastré / Profilo incasso



CODE	COLOR	SIZE	PRICE
85350	● Plata / Silver / Argent / Argento	2 m	22,95€

Power
Max 30W/m

Material
AL 6063



IP
20

 Customised

Escala / Scale / Échelle / Scala 1:1

Difusor / Diffuser / Diffuseurs / Diffusore

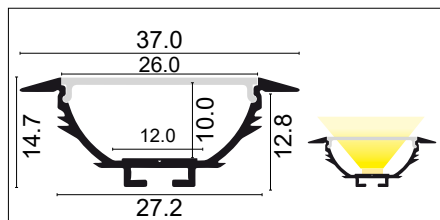

CODE	COLOR	SIZE	PRICE
85618	● Opal / Opale	2 m	7,95€

Tapas / Caps / Embout / Coperture

Grapas / Staples / Agrafes / Graffete

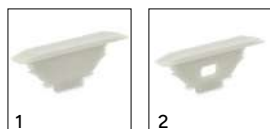

CODE 1	COLOR	PRICE
85357	● Plata / Silver / Argent / Argento	0,95€

CODE 1	COLOR	PRICE
85164	● Aluminio / Aluminium / Alluminio	0,99€

CODE 2	COLOR	PRICE
85356	● Plata / Silver / Argent / Argento	0,95€

CODE 2	COLOR	PRICE
85650	● Aluminio / Aluminium / Alluminio	3,95€

ZURICH

Perfil empotrar / Recessed profile / Profilé encastré / Profilo incasso



CODE	COLOR	SIZE	PRICE
85390	● Plata / Silver / Argent / Argento	2 m	28,95€
85391	○ Blanco / White / Blanc / Bianco	2 m	28,95€

Power
Max 30W/m

Material
AL 6063



IP
20

 Customised

Escala / Scale / Échelle / Scala 1:1

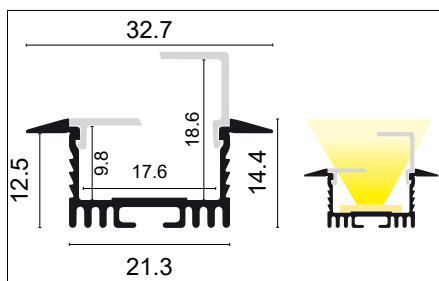

Difusor / Diffuser / Diffuseurs / Diffusore



CODE	COLOR	SIZE	PRICE
85602	● Opal / Opale	2 m	10,95€
85600	● Opal / Opale	2 m	16,95€

Tapas / Caps / Embout / Coperture

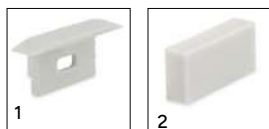

CODE 1	COLOR	PRICE
85396	● Plata / Silver / Argent / Argento	1,45€
85397	○ Blanco / White / Blanc / Bianco	1,45€

CODE 2: High Difusser (85600):

85660	● Plata / Silver / Argent / Argento	1,45€
85661	○ Blanco / White / Blanc / Bianco	1,45€

Grapas / Staples / Agrafes / Graffete



CODE	SIZE	PRICE
85650	● Aluminio / Aluminium / Alluminio	3,95€

ULSAN

Perfil empotrar / Recessed profile / Profilé encastré / Profilo incasso



CODE	COLOR	SIZE	PRICE
85410	● Plata / Silver / Argent / Argento	2 m	34,95€

Power
Max 30W/m

Material
AL 6063



IP
20

 Customised

Escala / Scale / Échelle / Scala 1:1

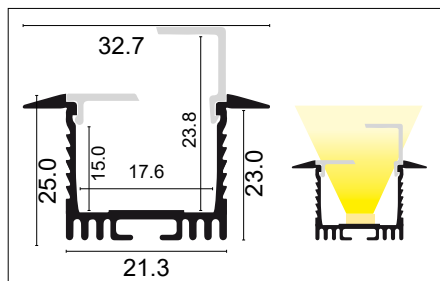

Difusor / Diffuser / Diffuseurs / Diffusore



CODE	COLOR	SIZE	PRICE
85602	● Opal / Opale	2 m	10,95€
85600	● Opal / Opale	2 m	16,95€

Tapas / Caps / Embout / Coperture

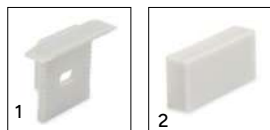

CODE 1	COLOR	PRICE
85413	● Plata / Silver / Argent / Argento	1,45€

CODE 2: High Difusser (85600):

85660	● Plata / Silver / Argent / Argento	1,45€
-------	-------------------------------------	-------

Grapas / Staples / Agrafes / Graffete



CODE	SIZE	PRICE
85650	● Aluminio / Aluminium / Alluminio	3,95€



CODE	COLOR	SIZE	PRICE
83600	● Plata / Silver / Argent / Argento	2 m	45,95€
83601	○ Blanco / White / Blanc / Bianco	2 m	52,65€
83602	● Negro / Black / Noir / Nero	2 m	52,65€

Power
Max 100W/m

Material
AL 6063



IP
20

✂
Customised

Escala / Scale / Échelle / Scala 1:1

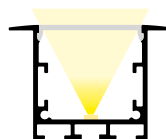
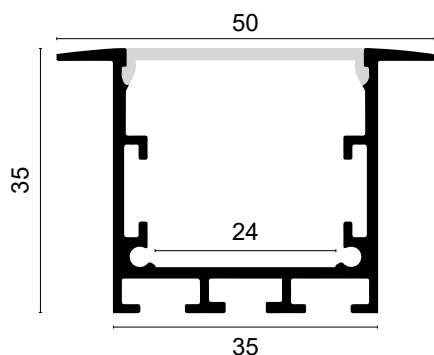

Grapas / Staples / Agrafes / Graffete



CODE	SIZE	PRICE
83142	● Aluminio / Aluminium / Alluminio	3,95€

Tapas / Caps / Embout / Coperture

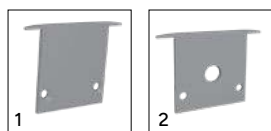

CODE 1	COLOR	PRICE
83604	● Plata / Silver / Argent / Argento	2,10€
83606	○ Blanco / White / Blanc / Bianco	2,10€
83608	● Negro / Black / Noir / Nero	2,10€
CODE 2		
83603	● Plata / Silver / Argent / Argento	2,10€
83605	○ Blanco / White / Blanc / Bianco	2,10€
83607	● Negro / Black / Noir / Nero	2,10€

Difusor / Diffuser / Diffuseurs / Diffusore

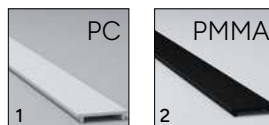

CODE 1	COLOR	SIZE	PRICE
83609	● Opal / Opale	2 m	9,95€
83615	● Opal / Opale	custom	5,95€
CODE 2			
83610	● Negro / Black / Noir / Nero	2 m	13,95€
83616	● Negro / Black / Noir / Nero	custom	7,95€

PERTH

Perfil empotrar / Recessed profile / Profilé encastré / Profilo incasso



CODE	COLOR	SIZE	PRICE
83620	● Plata / Silver / Argent / Argento	2 m	69,95€
83621	○ Blanco / White / Blanc / Bianco	2 m	74,95€
83622	● Negro / Black / Noir / Nero	2 m	74,95€

Power	Material		IP	
Max 100W/m	AL 6063		20	Customised

Escala / Scale / Échelle / Scala 1:1

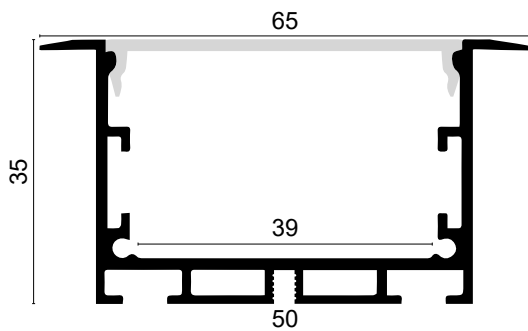

Grapas / Staples / Agrafes / Graffete



CODE	COLOR	PRICE
83632	● Aluminio / Aluminium / Alluminio	5,95€

Tapas / Caps / Embout / Coperture

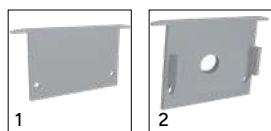

CODE 1	COLOR	PRICE
83624	● Plata / Silver / Argent / Argento	2,10€
83626	○ Blanco / White / Blanc / Bianco	2,10€
83628	● Negro / Black / Noir / Nero	2,10€

CODE 2	COLOR	PRICE
83623	● Plata / Silver / Argent / Argento	2,10€
83625	○ Blanco / White / Blanc / Bianco	2,10€
83627	● Negro / Black / Noir / Nero	2,10€

Difusor / Diffuser / Diffuseurs / Diffusore

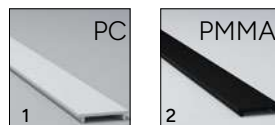

CODE 1	COLOR	SIZE	PRICE
83629	● Opal / Opale	2 m	12,85€
83635	● Opal / Opale	custom	7,95€

CODE 2	COLOR	SIZE	PRICE
83630	● Negro / Black / Noir / Nero	2 m	16,10€
83636	● Negro / Black / Noir / Nero	custom	9,95€

DELHI

Perfil empotrar / Recessed profile / Profilé encastré / Profilo incasso



CODE	COLOR	SIZE	PRICE
83171	○ Blanco / White / Blanc / Bianco	2 m	39,95€

Power
Max 30W/m

Material
AL 6063



IP
20



Customised

Escala / Scale / Échelle / Scala 1:1

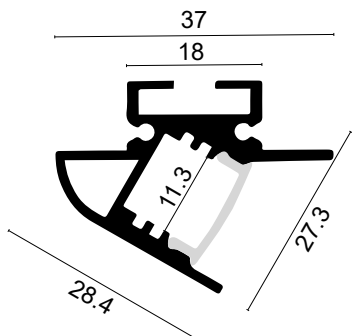

Grapas / Staples / Agrafes / Graffete



CODE	SIZE	PRICE
83142	● Aluminio / Aluminium / Alluminio	3,95€

Tapas / Caps / Embout / Coperture

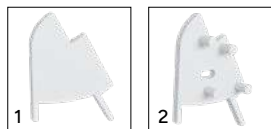

CODE 1	COLOR	PRICE
83176	○ Blanco / White / Blanc / Bianco	0,50€
CODE 2		
83175	○ Blanco / White / Blanc / Bianco	0,50€

Difusor / Diffuser / Diffuseurs / Diffusore



CODE	COLOR	SIZE	PRICE
83179	● Opal / Opale	2 m	6,95€



VOLGA

Perfil empotrar / Recessed profile / Profilé encastré / Profilo incasso



CODE	COLOR	SIZE	PRICE
85110	● Plata / Silver / Argent / Argento	3 m*	26,95€

Code 90040: Sellado IP65 para perfil estanco / IP65 sealing for watertight profile / Étanchéité IP65 pour profil étanche / Guarnizione IP65 per un profilo a tenuta stagna.

Power Max 30W/m	Material AL 6063		IP 20	 Customised
--------------------	---------------------	---	----------	--

Escala / Scale / Échelle / Scala 1:1

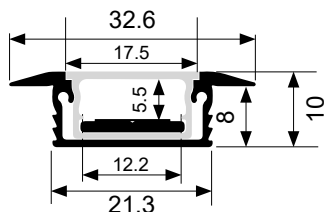

Pletina / Platen / Platine / Piastra a nastro



CODE	COLOR	SIZE	PRICE
85136	● Aluminio / Aluminium / Alluminio	3 m	10,95€

Difusor / Diffuser / Diffuseurs / Diffusore



CODE	COLOR	SIZE	PRICE
85107	● Opal / Opale	3 m	19,95€

Tapas / Caps / Embout / Copertura



CODE 1	COLOR	PRICE
85111	● Plata / Silver / Argent / Argento	0,50€
CODE 2		
85108	○ Blanco / White / Blanc / Bianco	1,95€

*Coste de envío a consultar en condiciones generales de venta. Shipping costs to be consulted in the general conditions of sale. Frais d'expédition à consulter dans les conditions générales de vente. Costi di spedizione da consultare nelle condizioni generali di vendita.

BRAVO

Perfil empotrar / Recessed profile / Profilé encastré / Profilo incasso



CODE	COLOR	SIZE	PRICE
85130	● Plata / Silver / Argent / Argento	3 m*	42,95€

Code 90040: Sellado IP65 para perfil estanco / IP65 sealing for watertight profile / Étanchéité IP65 pour profil étanche / Guarnizione IP65 per un profilo a tenuta stagna.

Power Max 30W/m	Material AL 6063		IP 20	 Customised
---------------------------	----------------------------	---	-----------------	--

Escala / Scale / Échelle / Scala 1:1

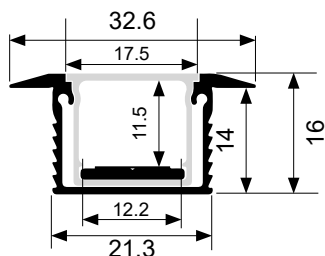

Pletina / Platen / Platine / Piastra a nastro



CODE	COLOR	SIZE	PRICE
85136	● Aluminio / Aluminium / Alluminio	3 m	10,95€

Difusor / Diffuser / Diffuseurs / Diffusore



CODE	COLOR	SIZE	PRICE
85127	● Opal / Opale	3 m	44,95€

Tapas / Caps / Embout / Coperture



CODE 1	COLOR	PRICE
85131	● Plata / Silver / Argent / Argento	0,50€
CODE 2		
85128	○ Blanco / White / Blanc / Bianco	1,95€

*Coste de envío a consultar en condiciones generales de venta. Shipping costs to be consulted in the general conditions of sale. Frais d'expédition à consulter dans les conditions générales de vente. Costi di spedizione da consultare nelle condizioni generali di vendita.



perfil arquitectónico



Perfil Arquitectónico

ES_ Los perfiles arquitectónicos están diseñados para transformar tus espacios con iluminación elegante y profesional. Perfectos para destacar estructuras y realzar el diseño arquitectónico con precisión y estilo.

Architectural profile

EN_ Architectural profiles are designed to transform your spaces with elegant and professional lighting. Perfect for highlighting structures and enhancing architectural design with precision and style.

Profilé architectural

FR_ Les profilés architecturaux sont conçus pour transformer vos espaces avec un éclairage élégant et professionnel. Parfaits pour mettre en valeur les structures et sublimer le design architectural avec précision et style.

Profili superficie

IT_ I profili architettonici sono progettati per trasformare i tuoi spazi con un'illuminazione elegante e professionale. Perfetti per valorizzare le strutture e migliorare il design architettonico con precisione e stile.



LIEJA

Perfil arquitectónico / Architectural profile / Profilé architectural / Profilo architettonico

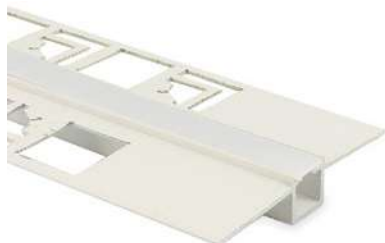

CODE	COLOR	SIZE	PRICE
85420	○ Blanco / White / Blanc / Bianco	3 m*	39,95€

Power
Max 30W/m

Material
AL 6063



IP
20

 Customised

Escala / Scale / Échelle / Scala 1:1

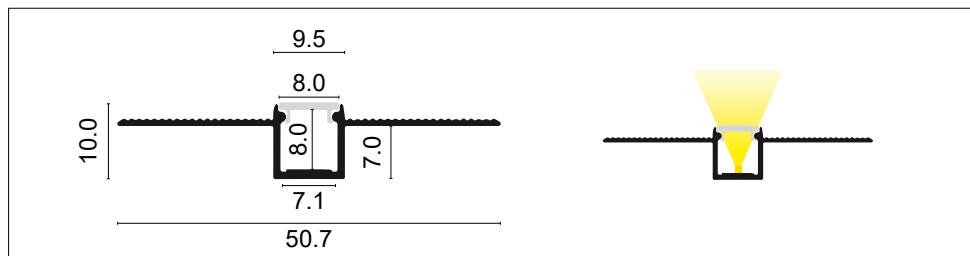

Difusor / Diffuser / Diffuseurs / Diffusore



CODE	COLOR	SIZE	PRICE
85607	● Opal / Opale	3 m	11,95€

*Coste de envío a consultar en condiciones generales de venta. Shipping costs to be consulted in the general conditions of sale. Frais d'expédition à consulter dans les conditions générales de vente. Costi di spedizione da consultare nelle condizioni generali di vendita.

VALENCIA

Perfil arquitectónico / Architectural profile / Profilé architectural / Profilo architettonico



CODE	COLOR	SIZE	PRICE
83031	○ Blanco / White / Blanc / Bianco	2 m	29,95€

Power
Max 30W/m

Material
AL 6063



IP
20

✂
Cutomised

Escala / Scale / Échelle / Scala 1:1

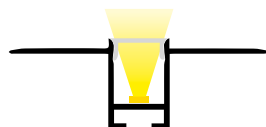
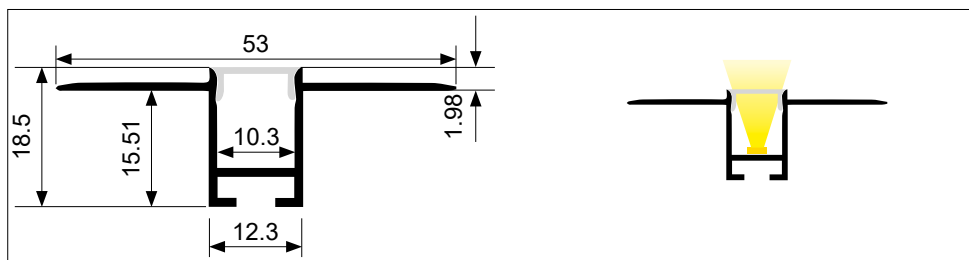

Tapas / Caps / Embout / Coperture

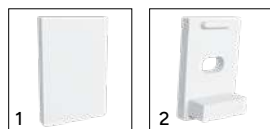

CODE 1	COLOR	PRICE
83036	○ Blanco / White / Blanc / Bianco	0,65€

CODE 2	COLOR	PRICE
83035	○ Blanco / White / Blanc / Bianco	0,65€

Grapas / Staples / Agrafes / Graffete



CODE	SIZE	PRICE
83142	● Aluminio / Aluminium / Alluminio	3,95€

Difusor / Diffuser / Diffuseurs / Diffusore



CODE	COLOR	SIZE	PRICE
83039	● Opal / Opale	2 m	5,95€

LUGO

Perfil arquitectónico / Architectural profile / Profilé architectural / Profilo architettonico



CODE	COLOR	SIZE	PRICE
85431	○ Blanco / White / Blanc / Bianco	3 m*	59,95€

Power
Max 30W/m

Material
AL 6063



IP
20

 Customised

Escala / Scale / Échelle / Scala 1:1

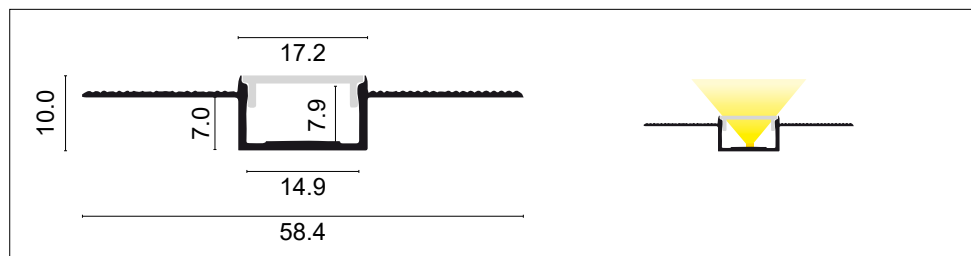

Difusor / Diffuser / Diffuseurs / Diffusore



CODE	COLOR	SIZE	PRICE
85198	● Opal / Opale	3 m	11,95€

*Coste de envío a consultar en condiciones generales de venta. Shipping costs to be consulted in the general conditions of sale. Frais d'expédition à consulter dans les conditions générales de vente. Costi di spedizione da consultare nelle condizioni generali di vendita.

HEFEI

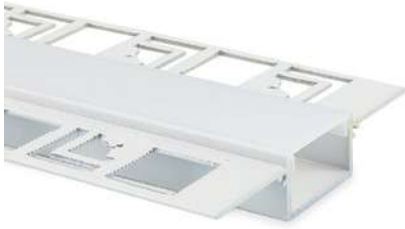

CODE	COLOR	SIZE	PRICE
85440	○ Blanco / White / Blanc / Bianco	2 m	39,95€

Power
Max 30W/m

Material
AL 6063



IP
20

Customised

Escala / Scale / Échelle / Scala 1:1

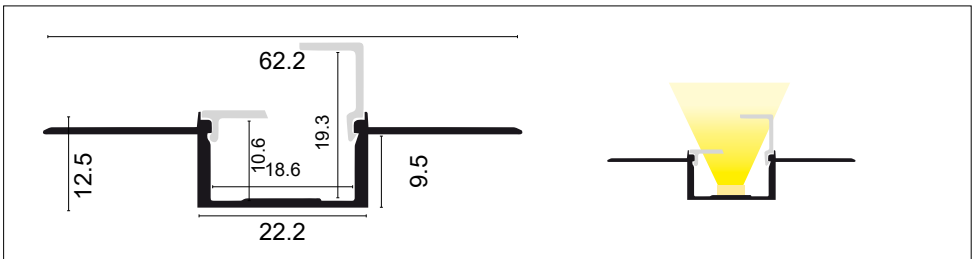

Tapas / Caps / Embout / Coperture

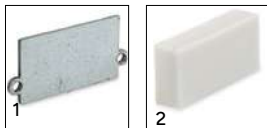

CODE 1	COLOR	PRICE
85444	● Plata / Silver / Argent / Argento	1,95€
CODE 2: High Difusor (85600):		
85660	● Plata / Silver / Argent / Argento	0,95€

Difusor / Diffuser / Diffuseurs / Diffusore



CODE	COLOR	SIZE	PRICE
85602	● Opal / Opale	2 m	10,95€
85600	● Opal / Opale	2 m	16,95€

SURAT

Perfil arquitectónico / Architectural profile / Profilé architectural / Profilo architettonico



CODE	COLOR	SIZE	PRICE
85450	○ Blanco / White / Blanc / Bianco	3 m*	89,95€

Power
Max 30W/m

Material
AL 6063



IP
20

 Customised

Escala / Scale / Échelle / Scala 1:1

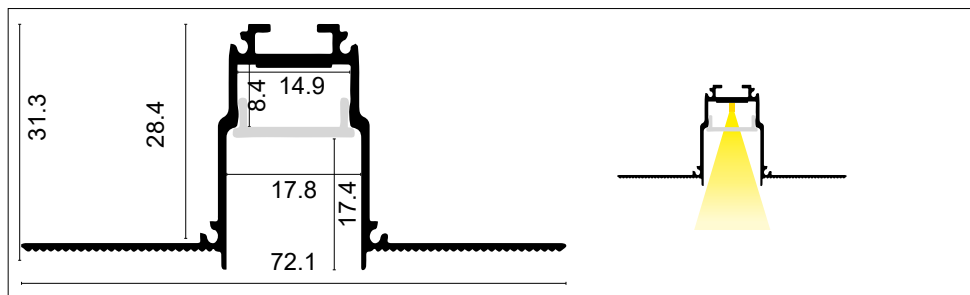

Tapas / Caps / Embout / Coperture



CODE	COLOR	PRICE
85454	● Plata / Silver / Argent / Argento	1,95€

Difusor / Diffuser / Diffuseurs / Diffusore



CODE	COLOR	SIZE	PRICE
85198	● Opal / Opale	3 m	11,95€

*Coste de envío a consultar en condiciones generales de venta. Shipping costs to be consulted in the general conditions of sale. Frais d'expédition à consulter dans les conditions générales de vente. Costi di spedizione da consultare nelle condizioni generali di vendita.

CALCUTA

Perfil arquitectónico / Architectural profile / Profilé architectural / Profilo architettonico



CODE	COLOR	SIZE	PRICE
85460	● Plata / Silver / Argent / Argento	3 m*	44,95€

Power
Max 30W/m

Material
AL 6063



IP
20

 Customised

Escala / Scale / Échelle / Scala 1:1

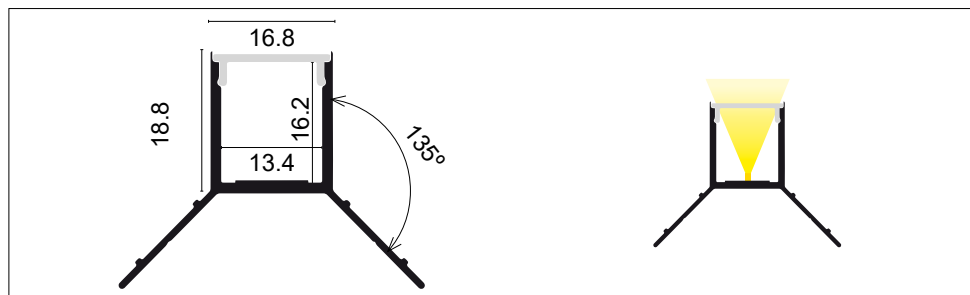

Difusor / Diffuser / Diffuseurs / Diffusore



CODE	COLOR	SIZE	PRICE
85198	● Opal / Opale	3 m	11,95€

*Coste de envío a consultar en condiciones generales de venta. Shipping costs to be consulted in the general conditions of sale. Frais d'expédition à consulter dans les conditions générales de vente. Costi di spedizione da consultare nelle condizioni generali di vendita.

BERNA



CODE	COLOR	SIZE	PRICE
85470	● Plata / Silver / Argent / Argento	2 m	39,95€

Power
Max 30W/m

Material
AL 6063



IP
20

 Customised

Escala / Scale / Échelle / Scala 1:1

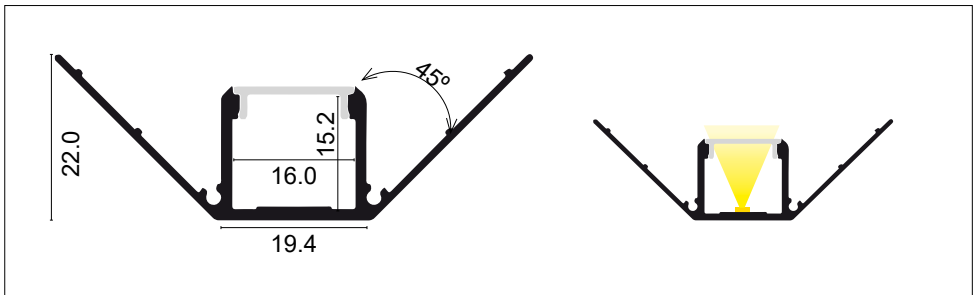

Difusor / Diffuser / Diffuseurs / Diffusore



CODE	COLOR	SIZE	PRICE
85161	● Opal / Opale	2 m	6,95€

CHICAGO

Perfil arquitectónico / Architectural profile / Profilé architectural / Profilo architettonico



CODE	COLOR	SIZE	PRICE
85220	● Plata / Silver / Argent / Argento	2 m	59,95€
85221	○ Blanco / White / Blanc / Bianco	2 m	63,95€

Power Max 30W/m	Material AL 6063	IP 20	 Customised
--------------------	---------------------	-----------------	---

Escala / Scale / Échelle / Scala 1:1

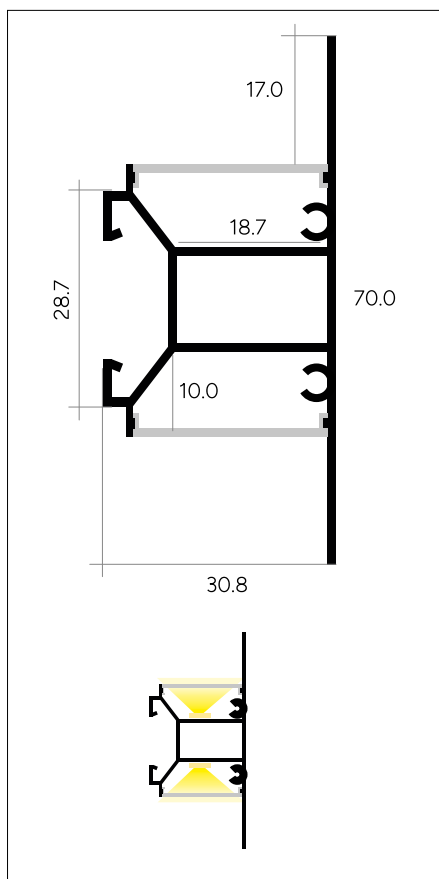

Difusor / Diffuser / Diffusers / Diffusore

*Requiere 2 difusores / Re-
quires 2 diffusers / Nécessite
2 diffuseurs / Richiede 2
diffusori

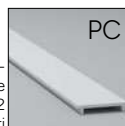

CODE	COLOR	SIZE	PRICE
85618*	● Opal / Opale	2 m	7,95€

Grapas / Staples / Agrafes / Graffete



CODE	COLOR	PRICE
85226	● Aluminio / Aluminium / Alluminio	0,80€

Tapas / Caps / Embout / Coperture

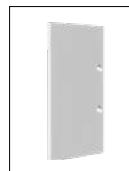

CODE	COLOR	PRICE
85224	● Plata / Silver / Argent / Argento	11,95€
85225	○ Blanco / White / Blanc / Bianco	11,95€

BURSA

Perfil arquitectónico / Architectural profile / Profilé architectural / Profilo architettonico



CODE	COLOR	SIZE	PRICE
83710	● Plata / Silver / Argent / Argento	2 m	24,95€
83711	○ Blanco / White / Blanc / Bianco	2 m	27,90€
83712	● Negro / Black / Noir / Nero	2 m	27,90€

Power
Max 30W/m

Material
AL 6063



IP
20

 Customised

Escala / Scale / Échelle / Scala 1:1

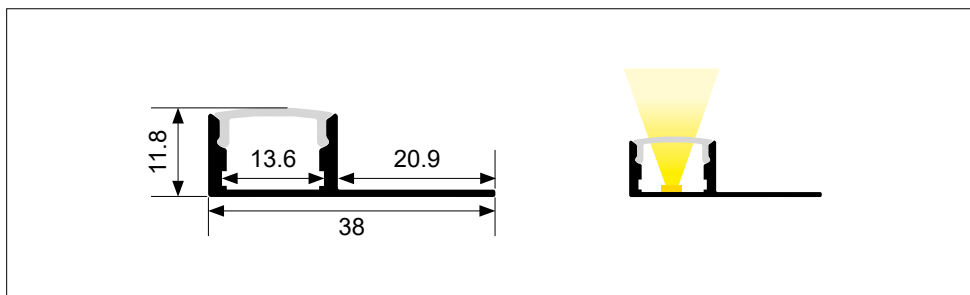

Tapas / Caps / Embout / Coperture

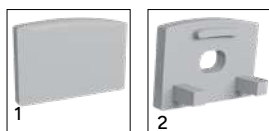

CODE 1	COLOR	PRICE
83714	● Plata / Silver / Argent / Argento	0,65€
83716	○ Blanco / White / Blanc / Bianco	0,65€
83718	● Negro / Black / Noir / Nero	0,65€

CODE 2

83713	● Plata / Silver / Argent / Argento	0,65€
83715	○ Blanco / White / Blanc / Bianco	0,65€
83717	● Negro / Black / Noir / Nero	0,65€

Difusor / Diffuser / Diffuseurs / Diffusore

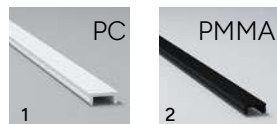

CODE 1	COLOR	SIZE	PRICE
83719	● Opal / Opale	2 m	6,75€

CODE 2

83720	● Negro / Black / Noir / Nero	2 m	7,45€
-------	-------------------------------	-----	-------

BARI

Perfil arquitectónico / Architectural profile / Profilé architectural / Profilo architettonico



CODE	COLOR	SIZE	PRICE
85050	○ Blanco / White / Blanc / Bianco	3 m*	37,95€

Power
Max 30W/m

Material
AL 6063



IP
20

Customised

Escala / Scale / Échelle / Scala 1:1

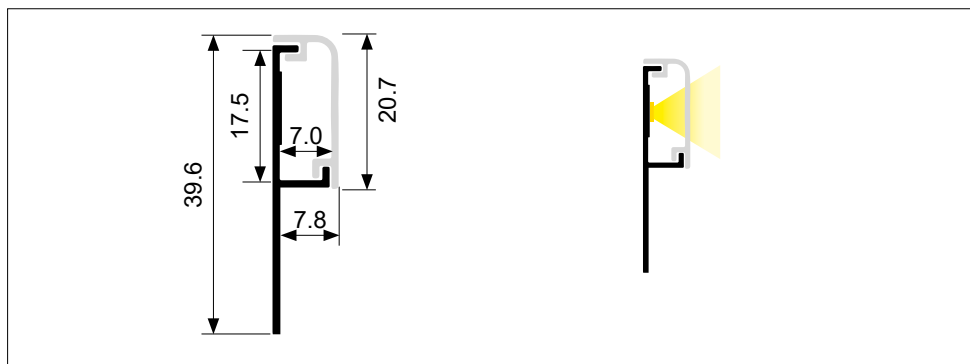

Difusor / Diffuser / Diffuseurs / Diffusore



CODE	COLOR	SIZE	PRICE
85051	● Opal / Opale	3 m	24,95€

*Coste de envío a consultar en condiciones generales de venta. Shipping costs to be consulted in the general conditions of sale. Frais d'expédition à consulter dans les conditions générales de vente. Costi di spedizione da consultare nelle condizioni generali di vendita.

CALGARY

Perfil arquitectónico / Architectural profile / Profilé architectural / Profilo architettonico



CODE	COLOR	SIZE	PRICE
85480	● Plata / Silver / Argent / Argento	3 m*	34,95€
85481	○ Blanco / White / Blanc / Bianco	3 m*	36,95€

Power
Max 30W/m

Material
AL 6063



IP
20

 Customised

Escala / Scale / Échelle / Scala 1:1

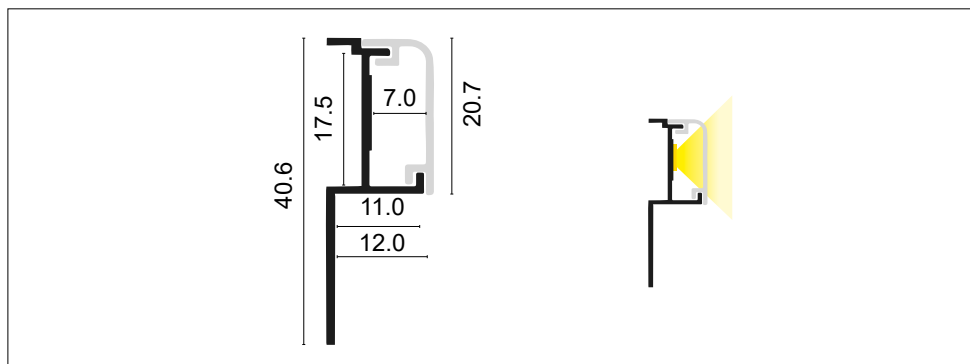

Difusor / Diffuser / Diffuseurs / Diffusore



CODE	COLOR	SIZE	PRICE
85051	● Opal / Opale	3 m	24,95€

*Coste de envío a consultar en condiciones generales de venta. Shipping costs to be consulted in the general conditions of sale. Frais d'expédition à consulter dans les conditions générales de vente. Costi di spedizione da consultare nelle condizioni generali di vendita.

VARNA

Perfil arquitectónico / Architectural profile / Profilé architectural / Profilo architettonico



CODE	COLOR	SIZE	PRICE
85070	○ Blanco / White / Blanc / Bianco	3 m*	69,95€

Power
Max 30W/m

Material
AL 6063



IP
20

Customised

Escaleta / Scale / Échelle / Scala 1:1

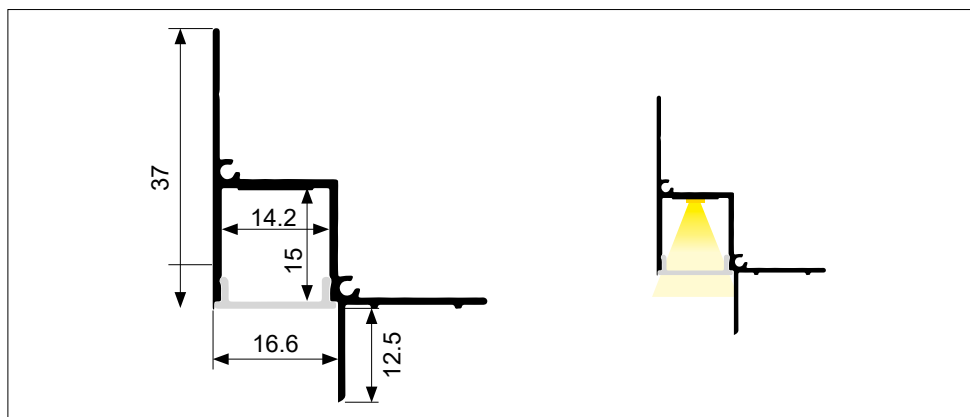

Difusor / Diffuser / Diffuseurs / Diffusore



CODE	COLOR	SIZE	PRICE
85198	● Opal / Opale	3 m	11,95€

*Coste de envío a consultar en condiciones generales de venta. Shipping costs to be consulted in the general conditions of sale. Frais d'expédition à consulter dans les conditions générales de vente. Costi di spedizione da consultare nelle condizioni generali di vendita.



SENA

Perfil arquitectónico / Architectural profile / Profilé architectural / Profilo architettonico



CODE	COLOR	SIZE	PRICE
85150	● Plata / Silver / Argent / Argento	3 m*	59,95€

Code 90040: Sellado IP65 para perfil estanco / IP65 sealing for watertight profile / Étanchéité IP65 pour profil étanche / Guarnizione IP65 per un profilo a tenuta stagna.

Power Max 30W/m	Material AL 6063		IP 20	 Customised
---------------------------	----------------------------	---	-----------------	--

Escala / Scale / Échelle / Scala 1:1

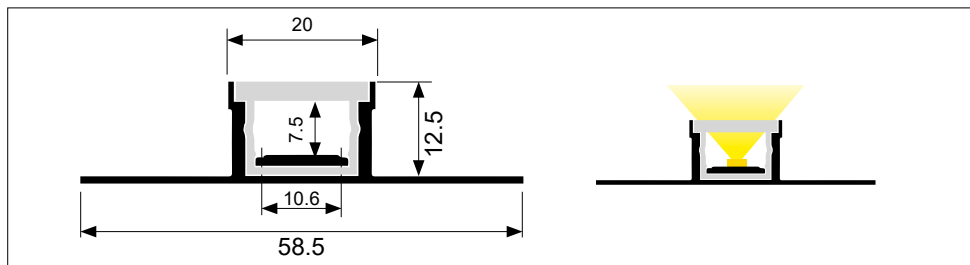

Pletina / Platen / Platine / Piastra a nastro



CODE	COLOR	SIZE	PRICE
85151	● Aluminio / Aluminium / Alluminio	3 m	9,95€

Difusor / Diffuser / Diffuseurs / Diffusore



CODE	COLOR	SIZE	PRICE
85152	● Opal / Opale	3 m	39,95€

Tapas / Caps / Embout / Coperture



CODE	COLOR	PRICE
85153	● Silicona / Silicone	1,45€



CODE	COLOR	SIZE	PRICE
85154	● Opal / Opale	3 m	15,95€

*Coste de envío a consultar en condiciones generales de venta. Shipping costs to be consulted in the general conditions of sale. Frais d'expédition à consulter dans les conditions générales de vente. Costi di spedizione da consultare nelle condizioni generali di vendita.



perfil de suelo



Perfil de suelo

ES_ Los perfiles de suelo son la combinación perfecta de funcionalidad y diseño. Ideales para crear caminos luminosos y destacar superficies, aportando seguridad y un toque moderno a cualquier espacio.

Soil profile

EN_ Floor profiles combine functionality and design perfectly. Ideal for creating illuminated pathways and highlighting surfaces, they add safety and a modern touch to any space.

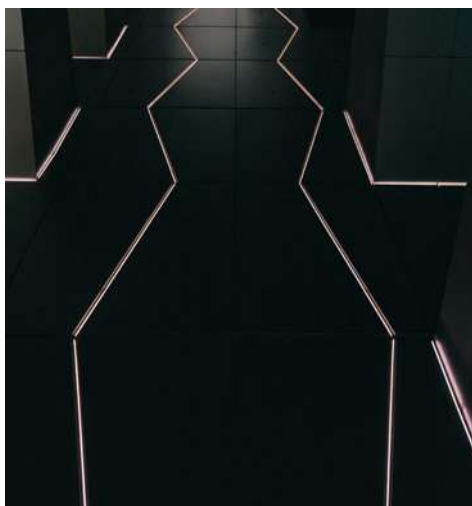

Profilé du sol

FR_ Les profilés de sol allient parfaitement fonctionnalité et design. Idéaux pour créer des chemins lumineux et mettre en valeur les surfaces, ils apportent sécurité et une touche moderne à tout espace.

Profilo del suolo

IT_ I profili da pavimento uniscono perfettamente funzionalità e design. Ideali per creare percorsi luminosi e valorizzare le superfici, offrono sicurezza e un tocco moderno a qualsiasi ambiente.



MACAU

Perfil de suelo / Soil profile / Profilé du sol / Profilo del suolo



CODE	COLOR	SIZE	PRICE
83730	● Plata / Silver / Argent / Argento	2 m	29,95€
83731	○ Blanco / White / Blanc / Bianco	2 m	34,95€
83732	● Negro / Black / Noir / Nero	2 m	34,95€

Power
Max 30W/m

Material
AL 6063



IP
20

 Customised

Escala / Scale / Échelle / Scala 1:1

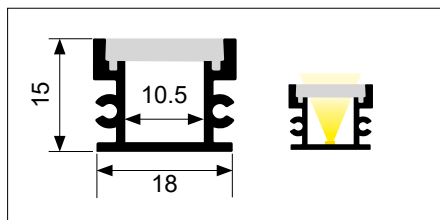

Difusor / Diffuser / Diffuseurs / Diffusore

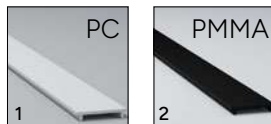

CODE 1	COLOR	SIZE	PRICE
83739	● Opal / Opale	2 m	14,95€

CODE 2

83740	● Negro / Black / Noir / Nero	2 m	16,95€
-------	-------------------------------	-----	--------

Tapas / Caps / Embout / Coperture

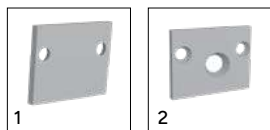

CODE 1	COLOR	PRICE
83734	● Plata / Silver / Argent / Argento	0,75€
83736	○ Blanco / White / Blanc / Bianco	0,75€
83738	● Negro / Black / Noir / Nero	0,75€

CODE 2

83733	● Plata / Silver / Argent / Argento	0,75€
83735	○ Blanco / White / Blanc / Bianco	0,75€
83737	● Negro / Black / Noir / Nero	0,75€

SEVILLA

Perfil de suelo / Soil profile / Profilé du sol / Profilo del suolo



CODE	COLOR	SIZE	PRICE
83300	● Plata / Silver / Argent / Argento	2 m	27,95€
83302	● Negro / Black / Noir / Nero	2 m	29,95€

Power
Max 30W/m

Material
AL 6063



IP
20

 Customised

Escala / Scale / Échelle / Scala 1:1

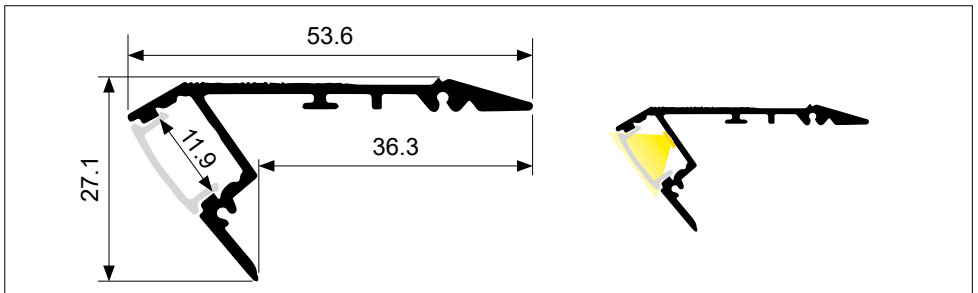

Tapas / Caps / Embout / Coperture

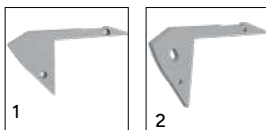

CODE 1	COLOR	PRICE
83304	● Plata / Silver / Argent / Argento	1,30€
83308	● Negro / Black / Noir / Nero	1,30€
CODE 2		
83303	● Plata / Silver / Argent / Argento	1,30€
83307	● Negro / Black / Noir / Nero	1,30€

Difusor / Diffuser / Diffuseurs / Diffusore

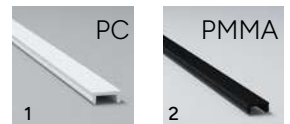

CODE 1	COLOR	SIZE	PRICE
83309	● Opal / Opale	2 m	5,25€
CODE 2			
83312	● Negro / Black / Noir / Nero	2 m	7,45€

perfil flexible



Perfil flexible

ES_ Los perfiles flexibles ofrecen máxima versatilidad para dar vida a diseños únicos y creativos. Adaptables a gran variedad de formas o superficies, son ideales para proyectos donde la imaginación no tiene límites.

Flexible profile

EN_ Flexible profiles offer maximum versatility to bring unique and creative designs to life. Adaptable to a wide variety of shapes or surfaces, they are perfect for projects where imagination knows no bounds.



Profilé flexible

FR_ Les profilés flexibles offrent une polyvalence maximale pour donner vie à des designs uniques et créatifs. Adaptables à une grande variété de formes ou de surfaces, ils sont parfaits pour des projets où l'imagination est sans limites.

Profilo flessibile

IT_ I profili flessibili offrono la massima versatilità per realizzare design unici e creativi. Adattabili a una grande varietà di forme o superfici, sono perfetti per progetti dove l'immaginazione non ha confini.



OSLO

Perfil flexible / Flexible profile / Profilé flexible / Profilo flessibile

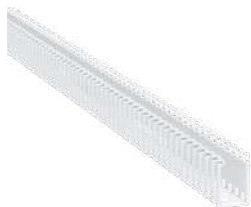

CODE	COLOR	SIZE	PRICE
83391	○ Blanco / White / Blanc / Bianco	2 m	99,95€

Power
Max 30W/m

Material
AL 6063



IP
20

 Customised

Escala / Scale / Échelle / Scala 1:1

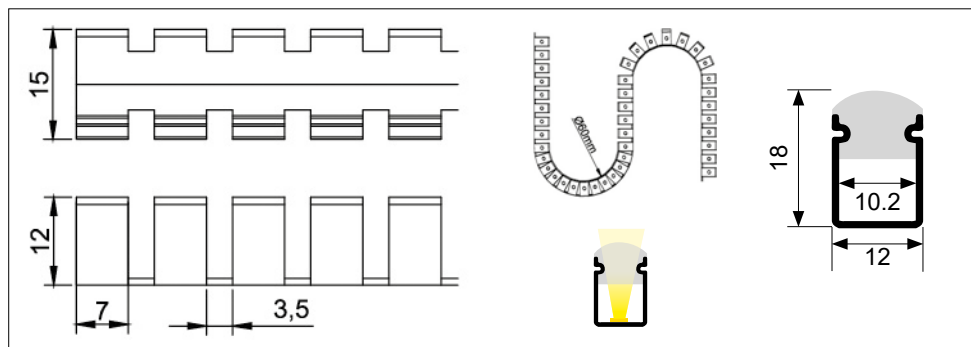

Tapas / Caps / Embout / Coperture

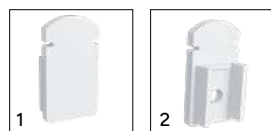

CODE 1	COLOR	PRICE
83395	○ Blanco / White / Blanc / Bianco	0,65€
CODE 2		
83396	○ Blanco / White / Blanc / Bianco	0,65€

Grapas / Staples / Agrafes / Graffete



CODE	COLOR	PRICE
83402	● Aluminio / Aluminium / Alluminio	0,65€

Difusor / Diffuser / Diffuseurs / Diffusore



CODE	COLOR	SIZE	PRICE
83399	● Opal / Opale	2 m	21,45€

NANTES



CODE	COLOR	SIZE	PRICE
83371	○ Blanco / White / Blanc / Bianco	2 m	17,95€

Power
Max 30W/m

Material
AL 6063



IP
20

 **Customised**

Escaleta / Scale / Échelle / Scala 1:1

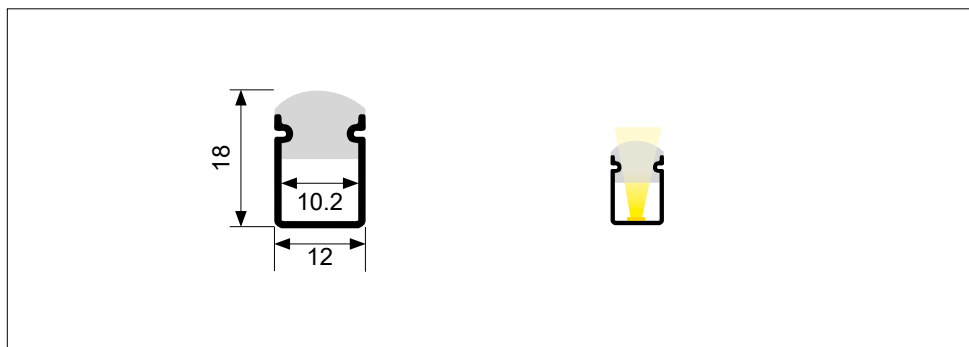

Tapas / Caps / Embout / Copertura

Grapas / Staples / Agrafes / Graffete

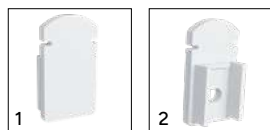

CODE 1	COLOR	PRICE
83376	○ Blanco / White / Blanc / Bianco	0,65€

CODE	COLOR	PRICE
83382	● Aluminio / Aluminium / Alluminio	0,65€

CODE 2	COLOR	PRICE
83375	○ Blanco / White / Blanc / Bianco	0,65€

Difusor / Diffuser / Diffuseurs / Diffusore

ES_ Nantes se combina con el perfil flexible OSLO para realizar trazados rectos. EN_ Nantes is combined with the flexible OSLO profile for straight lines. FR_ Nantes est combiné avec le profilé flexible OSLO pour les lignes droites. IT_ Nantes è abbinato al profilo flessibile OSLO per linee rette.



CODE	COLOR	SIZE	PRICE
83379	● Opal / Opale	2 m	21,45€

NIZA

Perfil flexible / Flexible profile / Profilé flexible / Profilo flessibile



CODE	COLOR	SIZE	PRICE
83411	○ Blanco / White / Blanc / Bianco	2 m	9,95€

Power
Max 30W/m

Material
AL 6063



IP
20

 Customised

Escala / Scale / Échelle / Scala 1:1

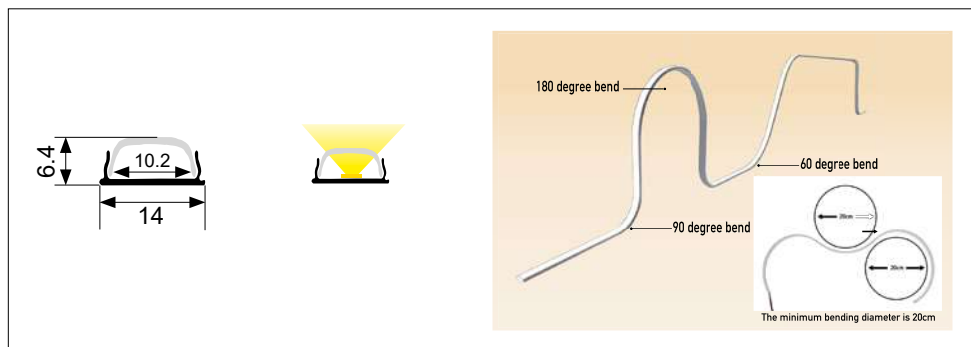

Tapas / Caps / Embout / Coperture

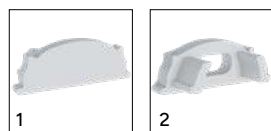

CODE 1	COLOR	PRICE
83416	○ Blanco / White / Blanc / Bianco	0,65€
CODE 2		
83415	○ Blanco / White / Blanc / Bianco	0,65€

Grapas / Staples / Agrafes / Graffete



CODE	COLOR	PRICE
83422	● Aluminio / Aluminium / Alluminio	0,65€

Difusor / Diffuser / Diffuseurs / Diffusore



CODE	COLOR	SIZE	PRICE
83419	● Opal / Opale	2 m	6,95€

HAIFA

Perfil flexible / Flexible profile / Profilé flexible / Profilo flessibile



CODE	COLOR	SIZE	PRICE
83431	○ Blanco / White / Blanc / Bianco	2 m	12,95€

Power
Max 30W/m

Material
AL 6063



IP
20

 **Customised**

Escala / Scale / Échelle / Scala 1:1

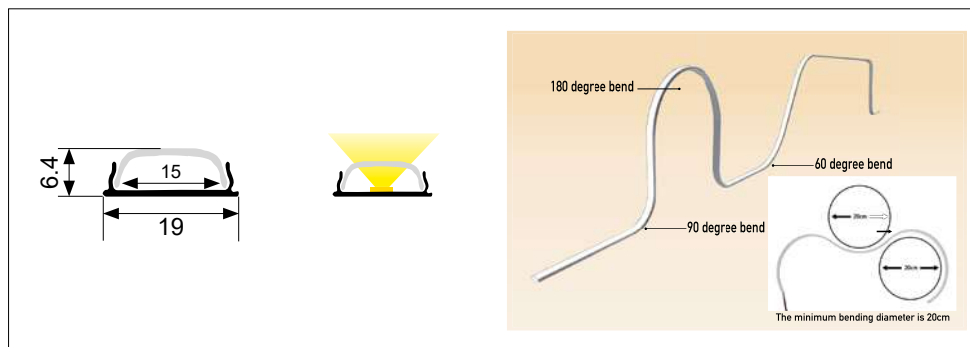

Tapas / Caps / Embout / Coperture

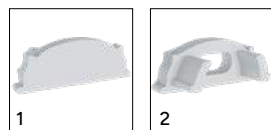

CODE 1	COLOR	PRICE
83436	○ Blanco / White / Blanc / Bianco	0,65€
CODE 2		
83435	○ Blanco / White / Blanc / Bianco	0,65€

Grapas / Staples / Agrafes / Graffete



CODE	COLOR	PRICE
83442	● Aluminio / Aluminium / Alluminio	0,80€

Difusor / Diffuser / Diffuseurs / Diffusore



CODE	COLOR	SIZE	PRICE
83439	● Opal / Opale	2 m	7,25€

perfil imantado



Perfil imantado

ES_ Los perfiles imantados ofrecen una instalación rápida y sin complicaciones gracias a su sistema magnético. Ideales para proyectos versátiles, permiten ajustes fáciles y un acabado limpio y profesional.

Magnetized profile

EN_ Magnetic profiles offer quick and hassle-free installation thanks to their magnetic system. Ideal for versatile projects, they allow for easy adjustments and a clean, professional finish.

Profilé aimanté

FR_ Les profilés magnétisés offrent une installation rapide et sans effort grâce à leur système magnétique. Idéaux pour des projets polyvalents, ils permettent des ajustements faciles et une finition propre et professionnelle.

Profilo magnetico

IT_ I profili magnetici offrono un'installazione rapida e senza complicazioni grazie al loro sistema magnetico. Ideali per progetti versatili, consentono regolazioni semplici e una finitura pulita e professionale.

BANGKOK

Perfil imantado / Magnetized profile / Profilé aimanté / Profilo magnetico



CODE	COLOR	SIZE	PRICE
83450	● Plata / Silver / Argent / Argento	2 m	12,95€

Power
Max 30W/m

Material
AL 6063



IP
20

✂
Cutomised

Escala / Scale / Échelle / Scala 1:1

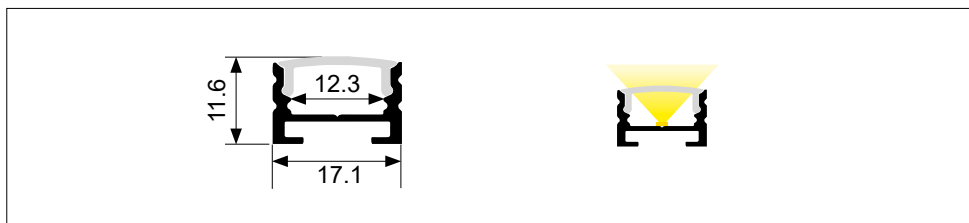

Tapas / Caps / Embout / Coperture

Difusor / Diffuser / Diffuseurs / Diffusore



CODE 1	COLOR	PRICE
83454	● Plata / Silver / Argent / Argento	0,65€

CODE	COLOR	SIZE	PRICE
83459	● Opal / Opale	2 m	6,95€

CODE 2	COLOR	PRICE
83453	● Plata / Silver / Argent / Argento	0,65€

Magnético / Magnetic / Magnétique / Magnetico



CODE	COLOR	PRICE
83463	● Magnético / Magnetic / Magnétique	2,95€

perfil armario



Perfil armario

ES_ Los perfiles para armario combinan funcionalidad y diseño, ofreciendo una solución práctica para integrar iluminación y almacenamiento en un solo sistema. Perfectos para espacios modernos y organizados.

Wardrobe profile

EN_ Wardrobe profiles combine functionality and design, offering a practical solution for integrating lighting and storage into a single system. Perfect for modern, organised spaces.



Profilé pour armoires

FR_ Les profilés pour armoires allient fonctionnalité et design, offrant une solution pratique pour intégrer éclairage et rangement dans un seul et même système. Parfaits pour les espaces modernes et organisés.

Profilo armadio

IT_ I profili per armadi combinano funzionalità e design, offrendo una soluzione pratica per integrare illuminazione e contenimento in un unico sistema. Perfetti per spazi moderni e organizzati.

ATLANTA

Perfil perchero / Coat rack profile / Profilé de portemanteau / Profilo appendiabiti



CODE	COLOR	SIZE	PRICE
83470	● Plata / Silver / Argent / Argento	2 m	29,95€
83472	● Negro / Black / Noir / Nero	2 m	34,95€

Power
Max 30W/m

Material
AL 6063



IP
20

 Customised

Escala / Scale / Échelle / Scala 1:1

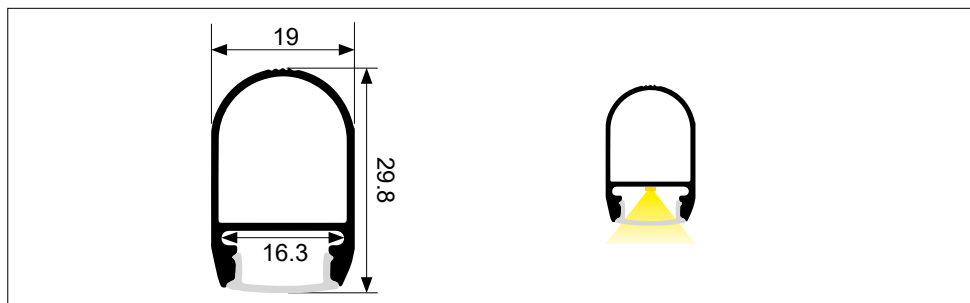

Apoyo / Support / Supporto



CODE 1	COLOR	PRICE
83482	Empotrar / Recessed / Encastré / Incasso	3,95€
CODE 2	COLOR	PRICE
83483	Superficie / Surface / Superficie	3,95€
CODE 3	COLOR	PRICE
83484	Colgante / Pendant / Suspension / Sospensione	3,95€

Difusor / Diffuser / Diffuseurs / Diffusore

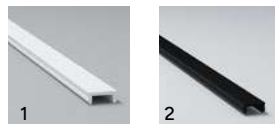

CODE 1	COLOR	SIZE	PRICE
83479	● Opal / Opale	2 m	5,95€
CODE 2	COLOR	SIZE	PRICE
83485	● Negro / Black / Noir / Nero	2 m	7,95€



ATENAS

Perfil para armarios / Recessed profile / Profilé encastré / Profilo incasso



CODE	COLOR	SIZE	PRICE
85210	● Plata / Silver / Argent / Argento	2 m	18,95€

Power
Max 30W/m

Material
AL 6063



IP
20

 Customised

Escala / Scale / Échelle / Scala 1:1

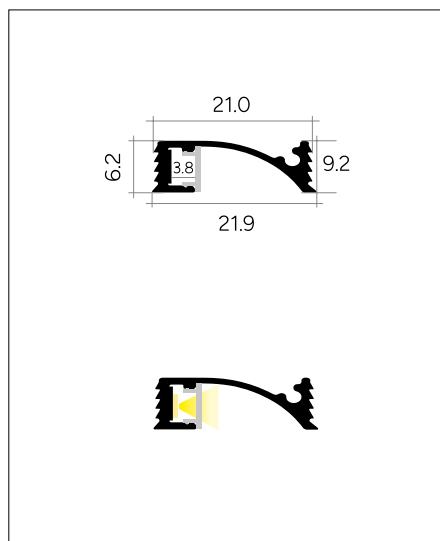

Difusor / Diffuser / Diffuseurs / Diffusore

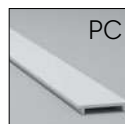

CODE	COLOR	SIZE	PRICE
85606	● Opal / Opale	2 m	7,95€

fuentes de alimentación



Fuentes de Alimentación

ES_ Descubre nuestra variedad de fuentes de alimentación IP20 e IP67 con potencias 12V, 24V y 48V. Soluciones eficientes y seguras para todo tipo de proyectos de iluminación LED, tanto en interiores como exteriores.

Power sources

EN_ Discover our range of IP20 and IP67 power supplies with 12V, 24V and 48V power. Efficient and safe solutions for all types of LED lighting projects, both indoors and outdoors.

Sources d'énergie

FR_ Découvrez notre gamme d'alimentations IP20 et IP67 avec puissances à 12V, 24V et 48V. Des solutions efficaces et sûres pour tous types de projets d'éclairage LED, aussi bien en intérieur qu'en extérieur.

Alimentatori

IT_ Scopri la nostra gamma di alimentatori IP20 e IP67 con potenze a 12V, 24V e 48V. Soluzioni efficienti e sicure per ogni tipo di progetto di illuminazione LED, sia per interni che per esterni.



POWER SUPPLY

12V



CODE	W	IP	INPUT V.	OUTPUT V.	OUTPUT CURR.	EFFICACY	DIMENSIONS	PRICE
85560	60W	IP67	AC 175-264V	DC12V	5A	93%	203*35*24mm	27,95€
85561	150W	IP67	AC 175-264V	DC12V	12,5A	93%	208*58*32mm	44,95€

POWER SUPPLY

48V

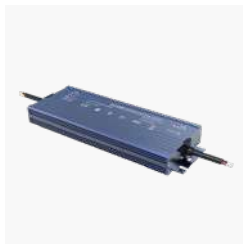

CODE	W	IP	INPUT V.	OUTPUT V.	OUTPUT CURR.	EFFICACY	DIMENSIONS	PRICE
85570	150W	IP67	AC 175-264V	DC48V	3,12A	93%	208*58*32mm	79,95€
85571	350W	IP67	AC 175-264V	DC48V	7,29A	93%	282*86*24mm	139,95€

POWER SUPPLY

24V



CODE	W	IP	INPUT V.	OUTPUT V.	OUTPUT CURR.	EFFICACY	DIMENSIONS	PRICE
85519	36W	IP20	AC 175-264V	DC24V	1,5A	93%	222*19.5*17mm	19,95€
85520	60W	IP20	AC 175-264V	DC24V	2,5A	93%	222*19.5*17mm	21,95€
85521	100W	IP20	AC 175-264V	DC24V	4,17A	93%	215.5*28*22.8mm	29,95€
85522	150W	IP20	AC 175-264V	DC24V	6,25A	93%	215.5*28*22.8mm	39,95€
85523	200W	IP20	AC 175-264V	DC24V	8,3A	93%	215.5*28*22.8mm	45,95€
85524	300W	IP20	AC 175-264V	DC24V	12,5A	93%	236*49*29mm	59,95€
85525	400W	IP20	AC 200-240V	DC24V	16,7A	93%	236*49*29mm	69,95€
85526	500W	IP20	AC 200-240V	DC24V	20,8A	93%	220*62*31mm	99,95€
85528	30W	IP67	AC 175-264V	DC24V	1,25A	93%	220*30*20mm	19,95€
85529	60W	IP67	AC 175-264V	DC24V	2,5A	93%	203*35*24mm	24,95€
85530	100W	IP67	AC 175-264V	DC24V	4,2A	93%	183*63*19mm	39,95€
85531	150W	IP67	AC 175-264V	DC24V	6,25A	93%	208*58*32mm	49,95€
85532	200W	IP67	AC 200-240V	DC24V	8,33A	93%	238*60*33mm	69,95€
85533	300W	IP67	AC 175-264V	DC24V	12,5A	93%	228*72*32mm	89,95€
85534	400W	IP67	AC 175-264V	DC24V	16A	93%	260*92*37mm	109,95€
85535	500W	IP67	AC 175-264V	DC24V	20,8A	93%	260*92*37mm	119,95€
85536	600W	IP67	AC 175-264V	DC24V	25A	93%	290*102*37mm	129,95€
DALI / PUSH								
85550	100W	IP67	AC 100-264V	DC24V	4,2A	93%	317*35*18mm	129,95€
85551	200W	IP67	AC 100-240V	DC24V	8,3A	93%	372*36*22,6mm	159,95€

POWER SUPPLY

24V



CODE	W	IP	INPUT V.	OUTPUT V.	OUTPUT CURR.	EFFICACY	TRIAC / 1-10V	
							DIMENSIONS	PRICE
85580	100W	IP20	AC100-277V	DC24V	4,2A	95%	205*38*26.5mm	169,95€
85581	200W	IP20	AC100-277V	DC24V	8,3A	93%	265*39*26.5mm	229,95€



CODE	W	IP	INPUT V.	OUTPUT V.	OUTPUT CURR.	EFFICACY	TRIAC / 1-10V	
							DIMENSIONS	PRICE
85585	100W	IP67	AC-100-264V	DC24V	4.2 A	95%	227*42*23.8mm	189,95€
85586	200W	IP67	AC100-277V	DC24V	8,3A	93%	265*39*26.5mm	249,95€



sistemas de control



Sistemas de control

ES_ Amplia gama de controladores en distintas aplicaciones, donde se presentan opciones de regulación monocolor, cambios de color RGB/RGBW, CCT y control de la tecnología LED lineal flexible ya sea a través de pulsadores, mandos a distancia, formato mecanismo, aplicación Android o IOS y siempre interconectados entre sí de forma inalámbrica.

Control System

EN_ Wide range of controllers in different applications, where there are monochrome dimming options, RGB/RGBW color changes, CCT and control of flexible linear LED technology either through push-buttons, remote controls, mechanism format, Android or IOS application and always interconnected with each other wirelessly.

Systèmes de contrôle

FR_ Large gamme de contrôleurs dans différentes applications, où il existe des options de gradation monochrome, des changements de couleur RVB/RGBW, CCT et le contrôle de la technologie LED linéaire flexible via des boutons-poussoirs, des télécommandes, un format de mécanisme, une application Android ou IOS et toujours interconnectés les uns avec les autres sans fil.

Sistemi di controllo

IT_ Ampia gamma di controllori in diverse applicazioni, in cui sono presenti opzioni di regolazione monocromatica, cambio di colore RGB/RGBW, CCT e controllo della tecnologia LED lineare flessibile sia tramite pulsanti, telecomandi, formato meccanismo, applicazione Android o IOS e sempre interconnessi tra loro in modo inalterato.



CONECTE VARIOS SISTEMAS DE RF

Nuestro WiFi-Relay (Wi-Fi Hub) le permite conectarse con una amplia variedad de sistemas de RF, incluidos controladores de LED/ LED regulables, luces inteligentes, atenuadores de 0-10 V y Triac.

CONNECT MULTIPLE RF SYSTEMS

Our WiFi-Relay (Wi-Fi Hub) allows you to connect with a wide variety of RF systems, including LED drivers, dimmable LED drivers, smart lights, 0-10V dimmers, and Triac.

CONNECTEZ PLUSIEURS SYSTÈMES RF

Notre WiFi-Relay (Wi-Fi Hub) vous permet de vous connecter à une grande variété de systèmes RF, y compris des pilotes LED, des pilotes LED dimmables, des lumières intelligentes, des gradateurs 0-10V et des Triac.

COLLEGARE PIÙ SISTEMI RF

Il nostro WiFi-Relay (Wi-Fi Hub) consente di collegarsi a un'ampia gamma di sistemi RF, tra cui driver LED, driver LED dimmerabili, luci intelligenti, dimmer 0-10V e Triac.



GRUPO INALÁMBRICO EN ZONAS MÚLTIPLES

Múltiples luces LED con controlador LED pueden ser controladas por un control remoto al mismo tiempo. Presione un solo botón de zona para seleccionar una o varias luces en una habitación. Los controles remotos pueden tener 1-8 botones de zona dependiendo de la serie. Aún más, puede seleccionar hasta 16 zonas diferentes en la aplicación LyoproAPP en su teléfono a través del convertidor Wifi-Relay.



WIRELESS GROIP IN MULTIPLE ZONES

Multiple LED controller LED lights can be controlled by one remote at the same time. Press a single zone button to select one or multiple lights in a room. Remote controls can have 1-8 zone buttons depending on the series. Even more, you can select up to 16 different zones in the LyoproAPP on your phone via the Wifi-Relay converter.

GROUPE SANS FIL DANS PLUSIEURS ZONES

Plusieurs lumières LED de contrôleur LED peuvent être contrôlées par une seule télécommande en même temps. Appuyez sur un seul bouton de zone pour sélectionner une ou plusieurs lumières dans une pièce. Les télécommandes peuvent avoir des boutons de 1 à 8 zones selon la série. De plus, vous pouvez sélectionner jusqu'à 16 zones différentes dans la LyoproAPP de votre téléphone via le convertisseur Wifi-Relay.

GRUPPO WIRELESS IN ZONE MULTIPLE

Più luci LED con controller LED possono essere controllate contemporaneamente da un unico telecomando. Premere un singolo pulsante di zona per selezionare una o più luci in una stanza. I telecomandi possono avere da 1 a 8 pulsanti di zona, a seconda della serie. Inoltre, è possibile selezionare fino a 16 zone diverse nell'app LyoproAPP sul telefono tramite il convertitore Wifi-Relay.

88520

24V



Controlador Monocolor 3A / Single color controller 3A / Contrôleur de couleur unique 3A / Controllore unicolore 3A



Control / Input signal / Signal d'entrée / Controllo	RF 2.4GHz
Voltaje de entrada / Input Voltage / Tension d'entrée / Tensione d'ingresso	12-24VDC
Tensión de salida / Output Voltage / Tension de sortie / Tensione di uscita	12-24VDC
Corriente de salida / Output Current / Courant de sortie / Corrente di uscita	1 Channel / 3A
Potencia de salida / Output Power / Puissance de sortie / Potenza in uscita	75W
Tamaño / Size / Taille / Dimensione	L60 x W14 mm
Distancia / Distance / Distanza	30 m
Temperatura de trabajo / Working Temperature / Température de fonctionnement / Temperatura di lavoro	-30°C~+55°C
Precio / Price / Prix / Prezzo	19,95€

88523

24V



Controlador RGB/RGBW 4x1A / RGB/RGBW 4x1A controller / Contrôleur RGB/RGBW 4x1A / Controllore RGB/RGBW 4x1A



Control / Input signal / Signal d'entrée / Controllo	RF 2.4GHz
Voltaje de entrada / Input Voltage / Tension d'entrée / Tensione d'ingresso	12-24VDC
Tensión de salida / Output Voltage / Tension de sortie / Tensione di uscita	12-24VDC
Corriente de salida / Output Current / Courant de sortie / Corrente di uscita	4 Channel / 3A
Potencia de salida / Output Power / Puissance de sortie / Potenza in uscita	4x24W
Tamaño / Size / Taille / Dimensione	L60 x W14 mm
Distancia / Distance / Distanza	30 m
Temperatura de trabajo / Working Temperature / Température de fonctionnement / Temperatura di lavoro	-30°C~+55°C
Precio / Price / Prix / Prezzo	23,95€

88500

24V



Controlador Monocolor 8A / Single color controller 8A / Contrôleur de couleur unique 8A / Controllore unicolore 8A



Control / Input signal / Signal d'entrée / Controllo	RF 2.4GHz + Push Dim
Voltaje de entrada / Input Voltage / Tension d'entrée / Tensione d'ingresso	5-48VDC
Tensión de salida / Output Voltage / Tension de sortie / Tensione di uscita	5-48VDC
Corriente de salida / Output Current / Courant de sortie / Corrente di uscita	1 Channel / 8A
Potencia de salida / Output Power / Puissance de sortie / Potenza in uscita	192W
Tamaño / Size / Taille / Dimensione	L97 x W33 x H18 mm
Distancia / Distance / Distanza	30 m
Temperatura de trabajo / Working Temperature / Température de fonctionnement / Temperatura di lavoro	-30°C~+55°C
Precio / Price / Prix / Prezzo	29,95€

88501

24V



Controlador Monocolor 15A / Single color controller 15A / Contrôleur de couleur unique 15A / Controllore unicolore 15A



Control / Input signal / Signal d'entrée / Controllo	RF 2.4GHz + Push Dim
Voltaje de entrada / Input Voltage / Tension d'entrée / Tensione d'ingresso	12-48VDC
Tensión de salida / Output Voltage / Tension de sortie / Tensione di uscita	12-48VDC
Corriente de salida / Output Current / Courant de sortie / Corrente di uscita	1 Channel / 15A
Potencia de salida / Output Power / Puissance de sortie / Potenza in uscita	360W
Tamaño / Size / Taille / Dimensione	L175 x W54 x H27 mm
Distancia / Distance / Distanza	30 m
Temperatura de trabajo / Working Temperature / Température de fonctionnement / Temperatura di lavoro	-30°C~+55°C
Precio / Price / Prix / Prezzo	49,95€

88502

24V



Controlador RGB/RGBW 4x5A / RGB/RGBW 4x5A controller / Contrôleur RGB/RGBW 4x5A / Controllore RGB/RGBW 4x5A



Control / Input signal / Signal d'entrée / Controllo	RF 2.4GHz + Push Dim
Voltaje de entrada / Input Voltage / Tension d'entrée / Tensione d'ingresso	12-36VDC
Tensión de salida / Output Voltage / Tension de sortie / Tensione di uscita	4x(12-36)VDC
Corriente de salida / Output Current / Courant de sortie / Corrente di uscita	4 Channel / 5A / CH
Potencia de salida / Output Power / Puissance de sortie / Potenza in uscita	4x120W
Tamaño / Size / Taille / Dimensione	L175 x W45 x H27 mm
Distancia / Distance / Distanza	30 m
Temperatura de trabajo / Working Temperature / Température de fonctionnement / Temperatura di lavoro	-30°C~+55°C
Precio / Price / Prix / Prezzo	49,95€

88524

24V



Controlador inalámbrico RGB/RGBW 4x5A / Wireless RGB/RGBW Controller 4x5A / Contrôleur sans fil RGB/RGBW 4x5A / Controllore wireless RGB/RGBW 4x5A



Control / Input signal / Signal d'entrée / Controllo	RF 2.4GHz + Push Dim
Voltaje de entrada / Input Voltage / Tension d'entrée / Tensione d'ingresso	12-48VDC
Tensión de salida / Output Voltage / Tension de sortie / Tensione di uscita	4x(12-48)VDC
Corriente de salida / Output Current / Courant de sortie / Corrente di uscita	4 Channel / 5A
Potencia de salida / Output Power / Puissance de sortie / Potenza in uscita	4x(60-240W)
Tamaño / Size / Taille / Dimensione	L165 x W98 x H72 mm
Distancia / Distance / Distanza	30 m
Temperatura de trabajo / Working Temperature / Température de fonctionnement / Temperatura di lavoro	-30°C~+55°Cmm
Precio / Price / Prix / Prezzo	99,95€

88514

24V



Controlador RGB, RGBW, RGB+CCT 5x5A / RGB, RGBW, RGB+CCT controller 5x5A/ Contrôleur RGB, RGBW, RGB+CCT 5x5A / Controllore RGB, RGBW, RGB+CCT 5x5A



Control / Input signal / Signal d'entrée / Controllo	RF 2.4GHz + Push Dim
Voltaje de entrada / Input Voltage / Tension d'entrée / Tensione d'ingresso	12-24VDC
Tensión de salida / Output Voltage / Tension de sortie / Tensione di uscita	5x(12-24)VDC
Corriente de salida / Output Current / Courant de sortie / Corrente di uscita	5 Channel / 5A
Potencia de salida / Output Power / Puissance de sortie / Potenza in uscita	5x120W
Tamaño / Size / Taille / Dimensione	L175 x W14 x H27 mm
Distancia / Distance / Distanza	30 m
Temperatura de trabajo / Working Temperature / Température de fonctionnement / Temperatura di lavoro	-30°C~+55°Cmm
Precio / Price / Prix / Prezzo	64,95€

88551

24V



TUYA monocolor y CCT 2x5A / TUYA single color and CCT 2x5A / TUYA unicolore et CCT 2x5A / TUYA unicolore e CCT 2x5A



Control / Input signal / Signal d'entrée / Controllo	Tuya APP + RF Push Dim
Voltaje de entrada / Input Voltage / Tension d'entrée / Tensione d'ingresso	12-36VDC
Tensión de salida / Output Voltage / Tension de sortie / Tensione di uscita	2X(12-36)VDC
Corriente de salida / Output Current / Courant de sortie / Corrente di uscita	2x5A/CH
Potencia de salida / Output Power / Puissance de sortie / Potenza in uscita	2x120W
Tamaño / Size / Taille / Dimensione	L114 x W38 x H20 mm
Distancia / Distance / Distanza	30 m
Temperatura de trabajo / Working Temperature / Température de fonctionnement / Temperatura di lavoro	-30°C~+55°C
Precio / Price / Prix / Prezzo	76,95€

88552

24V



Sistema TUYA monocolor y RGB, RGBW, RGB+CCT 5x3A / TUYA single color and RGB, RGBW, RGB+CCT 5x3A / TUYA unicolore et RGB, RGBW, RGB+CCT 5x3A / TUYA unicolore e RGB, RGBW, RGB+CCT 5x3A



Control / Input signal / Signal d'entrée / Controllo	Tuya APP + RF Push Dim
Voltaje de entrada / Input Voltage / Tension d'entrée / Tensione d'ingresso	12-24VDC
Tensión de salida / Output Voltage / Tension de sortie / Tensione di uscita	5x(12-24)VDC
Corriente de salida / Output Current / Courant de sortie / Corrente di uscita	5x3A/CH
Potencia de salida / Output Power / Puissance de sortie / Potenza in uscita	5x120W
Tamaño / Size / Taille / Dimensione	L114 x W38 x H20 mm
Distancia / Distance / Distanza	30 m
Temperatura de trabajo / Working Temperature / Température de fonctionnement / Temperatura di lavoro	-30°C~+55°Cmm
Precio / Price / Prix / Prezzo	79,95€

88503

230V



Regulador inalámbrico AC TRIAC + PUSH 1,5A / Wireless AC TRIAC + PUSH 1,5A regulador / Régulateur TRIAC AC + PUSH 1,5A sans fil / Controllore wireless TRIAC AC + PUSH 1,5A



Control / Input signal / Signal d'entrée / Controllo	RF 2.4GHz + Push Dim
Voltaje de entrada / Input Voltage / Tension d'entrée / Tensione d'ingresso	AC 100-240VAC
Tensión de salida / Output Voltage / Tension de sortie / Tensione di uscita	AC 100-240VAC
Corriente de salida / Output Current / Courant de sortie / Corrente di uscita	Max 1.5A
Potencia de salida / Output Power / Puissance de sortie / Potenza in uscita	360W
Tamaño / Size / Taille / Dimensione	L52 x W52 x H26 mm
Distancia / Distance / Distanza	30 m
Temperatura de trabajo / Working Temperature / Température de fonctionnement / Temperatura di lavoro	-30°C~+55°C
Precio / Price / Prix / Prezzo	59,95€

88556

230V



Sistema TUYA regulador AC TRIAC 1.5A / TUYA AC dimmer TRIAC 1.5A / TUYA AC regulateur TRIAC 1.5A / TUYA Regolatore AC TRIAC 1,5A



Control / Input signal / Signal d'entrée / Controllo	Tuya APP + RF Push Dim
Voltaje de entrada / Input Voltage / Tension d'entrée / Tensione d'ingresso	AC 100-240VAC
Tensión de salida / Output Voltage / Tension de sortie / Tensione di uscita	AC 100-240VAC
Corriente de salida / Output Current / Courant de sortie / Corrente di uscita	Max 1.5A
Potencia de salida / Output Power / Puissance de sortie / Potenza in uscita	360W
Tamaño / Size / Taille / Dimensione	L52 x W52 x H26 mm
Distancia / Distance / Distanza	30 m
Temperatura de trabajo / Working Temperature / Température de fonctionnement / Temperatura di lavoro	-30°C~+55°C
Precio / Price / Prix / Prezzo	89,95€

88568

230V



Regulador 0/1-10V a AC TRIAC 2A / Regulator 0/1-10V to AC TRIAC 2A / Régulateur 0/1-10V a AC TRIAC 2A / Regolatore da 0/1-10V a TRIAC AC 2A



Control / Input signal / Signal d'entrée / Controllo	RF + 0/1-10V + AC Push
Voltaje de entrada / Input Voltage / Tension d'entrée / Tensione d'ingresso	AC 100-240VAC
Corriente de salida / Output Current / Courant de sortie / Corrente di uscita	AC 100-240VAC
Salida de señal / Output signal / Sortie du signal / Segnale in uscita	Max 2A
Tamaño / Size / Taille / Dimensione	L175 x W45 x H27 mm
Distancia / Distance / Distanza	30 m
Temperatura de trabajo / Working Temperature / Température de fonctionnement / Temperatura di lavoro	-30°C~+55°C
Precio / Price / Prix / Prezzo	84,95€

88555

230V



TUYA interruptor ON/OFF 1.5A / TUYA ON/OFF switch 1.5A / Interrupteur ON/OFF TUYA 1.5A / Interruttore TUYA ON/OFF 1,5A



Control / Input signal / Signal d'entrée / Controllo	Tuya APP + RF Push Dim
Voltaje de entrada / Input Voltage / Tension d'entrée / Tensione d'ingresso	AC 100-240VAC
Tensión de salida / Output Voltage / Tension de sortie / Tensione di uscita	AC 100-240VAC
Corriente de salida / Output Current / Courant de sortie / Corrente di uscita	Max 1.5A
Potencia de salida / Output Power / Puissance de sortie / Potenza in uscita	360W
Tamaño / Size / Taille / Dimensione	L52 x W52 x H26 mm
Distancia / Distance / Distanza	30 m
Temperatura de trabajo / Working Temperature / Température de fonctionnement / Temperatura di lavoro	-30°C~+55°C
Precio / Price / Prix / Prezzo	82,95€

88506

230V



Controlador regulable RGB inalámbrico 3x1A / Wireless RGB controller 3x1A / Contrôleur RGB sans fil 3x1A / Controllore RGB wireless 3x1A



Control / Input signal / Signal d'entrée / Controllo	RF 2.4GHz + Push Dim
Voltaje de entrada / Input Voltage / Tension d'entrée / Tensione d'ingresso	110-240VAC
Tensión de salida / Output Voltage / Tension de sortie / Tensione di uscita	3x(110-240)VAC
Corriente de salida / Output Current / Courant de sortie / Corrente di uscita	3 CH 1A/CH
Potencia de salida / Output Power / Puissance de sortie / Potenza in uscita	3X240W
Tamaño / Size / Taille / Dimensione	L175 x W45 x H27 mm
Distancia / Distance / Distanza	30 m
Temperatura de trabajo / Working Temperature / Température de fonctionnement / Temperatura di lavoro	-30°C~+55°C
Precio / Price / Prix / Prezzo	99,95€

88550

230V



Repetidor de señal / Signal booster / Relais de signal / Ripetitore di segnale

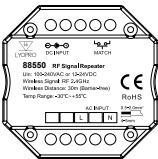

Control / Input signal / Signal d'entrée / Controllo	RF 2.4GHz + Push Dim
Voltaje de entrada / Input Voltage / Tension d'entrée / Tensione d'ingresso	AC 100-240VAC
Tensión de salida / Output Voltage / Tension de sortie / Tensione di uscita	AC 100-240VAC
Corriente de salida / Output Current / Courant de sortie / Corrente di uscita	Max 1.5A
Potencia de salida / Output Power / Puissance de sortie / Potenza in uscita	360W
Tamaño / Size / Taille / Dimensione	L52 x W52 x H26 mm
Distancia / Distance / Distanza	30 m
Temperatura de trabajo / Working Temperature / Température de fonctionnement / Temperatura di lavoro	-30°C~+55°C
Precio / Price / Prix / Prezzo	54,95€

88560

0/1-10V 230V



Regulador 0/1-10V para 1 luminaria / Regulator for 1 luminaire 0/1-10V / Regulateur 0/1-10V pour 1 luminaire / Regolatore 0/1-10V per 1 apparecchio di illuminazione



Control / Input signal / Signal d'entrée / Controllo	RF 2.4GHz + Push Dim
Voltaje de entrada / Input Voltage / Tension d'entrée / Tensione d'ingresso	AC 100-240V
Corriente de salida / Output Current / Courant de sortie / Corrente di uscita	Max 1.5A
Salida de señal / Output signal / Sortie du signal / Segnale in uscita	0/1-10V (20mA)
Tamaño / Size / Taille / Dimensione	L52 x W52 x H26 mm
Distancia / Distance / Distanza	30 m
Temperatura de trabajo / Working Temperature / Température de fonctionnement / Temperatura di lavoro	-30°C~+55°C
Precio / Price / Prix / Prezzo	59,95€

88561

0/1-10V 12V



Regulador 0/1-10V para 4 luminarias / Regulator for 4 luminaires 0/1-10V / Regulateur 0/1-10V pour 4 luminaires /
Regolatore 0/1-10V per 4 apparecchi d'illuminazione



Control / Input signal / Signal d'entrée / Controllo	RF 2.4GHz
Voltaje de entrada / Input Voltage / Tension d'entrée / Tensione d'ingresso	100-240VAC-12VDC
Corriente de salida / Output Current / Courant de sortie / Corrente di uscita	4CH 10mA/CH
Salida de señal / Output signal / Sortie du signal / Segnale in uscita	4x(0-10)VDC
Tamaño / Size / Taille / Dimensione	L114 x W38 x H20 mm
Distancia / Distance / Distanza	30 m
Temperatura de trabajo / Working Temperature / Température de fonctionnement / Temperatura di lavoro	-30°C~+55°C
Precio / Price / Prix / Prezzo	69,95€

88562

0/1-10V 12V



Regulador 0/1-10V para 4 luminarias (repetidor) / Regulator for 4 luminaires 0/1-10V (repeater) / Regulateur 0/1-10V
pour 4 luminaires (repetiteur) / Regolatore 0/1-10V per 4 apparecchi d'illuminazione (Ripetitore)



Control / Input signal / Signal d'entrée / Controllo	RF 2.4GHz
Voltaje de entrada / Input Voltage / Tension d'entrée / Tensione d'ingresso	100-240VAC-12VDC
Corriente de salida / Output Current / Courant de sortie / Corrente di uscita	0/1-10V: 20mA/CH Max 3
Salida de señal / Output signal / Sortie du signal / Segnale in uscita	4x(0-10)VDC
Tamaño / Size / Taille / Dimensione	L175 x W45 x H27 mm
Distancia / Distance / Distanza	30 m
Temperatura de trabajo / Working Temperature / Température de fonctionnement / Temperatura di lavoro	-30°C~+55°C
Precio / Price / Prix / Prezzo	89,95€

88564

DALI/24V



Regulador DALI 15A 24V / DALI dimmer 15A 24V / Regulateur DALI 15A 24V / Regolatore DALI 15A 24V



Control / Input signal / Signal d'entrée / Controllo	DALI + Push Dim
Voltaje de entrada / Input Voltage / Tension d'entrée / Tensione d'ingresso	12-48VDC
Tensión de salida / Output Voltage / Tension de sortie / Tensione di uscita	12-48VDC
Corriente de salida / Output Current / Courant de sortie / Corrente di uscita	1CH 15A
Potencia de salida / Output Power / Puissance de sortie / Potenza in uscita	360W
Tamaño / Size / Taille / Dimensione	L175 x W45 x H27 mm
Distancia / Distance / Distanza	30 m
Temperatura de trabajo / Working Temperature / Température de fonctionnement / Temperatura di lavoro	-30°C~+55°C
Precio / Price / Prix / Prezzo	69,95€

88565

DALI/24V



Regulador DALI 4x5A 24V / DALI dimmer 4x5A 24V / Regulateur DALI 4x5A 24V / Regolatore DALI 4x5A 24V



Control / Input signal / Signal d'entrée / Controllo	DALI
Voltaje de entrada / Input Voltage / Tension d'entrée / Tensione d'ingresso	12-48VDC
Tensión de salida / Output Voltage / Tension de sortie / Tensione di uscita	12-48VDC
Corriente de salida / Output Current / Courant de sortie / Corrente di uscita	4CH 5A/ CH
Potencia de salida / Output Power / Puissance de sortie / Potenza in uscita	4x120W
Tamaño / Size / Taille / Dimensione	L175 x W45 x H27 mm
Distancia / Distance / Distanza	30 m
Temperatura de trabajo / Working Temperature / Température de fonctionnement / Temperatura di lavoro	-30°C~+55°C
Precio / Price / Prix / Prezzo	87,95€

88563

DALI/230V



Controlador DALI A AC TRIAC 1.5A / DALI controller to AC TRIAC 1.5A / Regulateur DALI vers AC TRIAC 1.5A / Controller DALI A AC TRIAC 1,5A

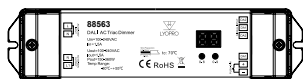

Control / Input signal / Signal d'entrée / Controllo	DALI
Voltaje de entrada / Input Voltage / Tension d'entrée / Tensione d'ingresso	AC 100-240VAC
Tensión de salida / Output Voltage / Tension de sortie / Tensione di uscita	AC 100-240VAC
Corriente de salida / Output Current / Courant de sortie / Corrente di uscita	1CH 15A
Potencia de salida / Output Power / Puissance de sortie / Potenza in uscita	360W
Tamaño / Size / Taille / Dimensione	L187 x W46 x H22 mm
Distancia / Distance / Distanza	30 m
Temperatura de trabajo / Working Temperature / Température de fonctionnement / Temperatura di lavoro	-30°C~+55°C
Precio / Price / Prix / Prezzo	82,95€

Convierte cualquier instalación en un sistema *smart* sin obras, sin cableado adicional y sin complicaciones.



CASAMBI

Control total desde tu móvil.

Funciona con **Bluetooth Low Energy**, la misma tecnología que usa tu smartwatch o tus auriculares. Desde la app puedes encender y apagar luces, regular la intensidad, cambiar colores (si la luminaria lo permite), crear escenas y ambientes, programar horarios y agrupar zonas para gestionar espacios completos, todo desde tu móvil, tablet o cualquier dispositivo.



Paleta de colores



Ajuste del ciclo solar



Control de horario



Temperatura de color



Control por grupos



Escenarios personalizados



Interfaz visual personalizable



Control por luz natural



Sensor de movimiento



Control sin conflictos

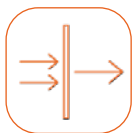

Control remoto

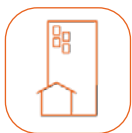

Escalabilidad flexible



Red sincronizada



Personalización avanzada



88576

TRIAC/230V



Controlador CASAMBI Bluetooth + Rf Triac Dimmer / CASAMBI Bluetooth + RF Triac Dimmer Controller / Contrôleur CASAMBI Bluetooth + Variateur Triac RF / Controller CASAMBI Bluetooth + Dimmer Triac RF



Control / Input signal / Signal d'entrée / Controllo	RF 2.4GHz + Push Dim
Voltaje de entrada / Input Voltage / Tension d'entrée / Tensione d'ingresso	AC 100-240VAC
Tensión de salida / Output Voltage / Tension de sortie / Tensione di uscita	AC 100-240VAC
Corriente de salida / Output Current / Courant de sortie / Corrente di uscita	Max 1.5A
Potencia de salida / Output Power / Puissance de sortie / Potenza in uscita	360W
Tamaño / Size / Taille / Dimensione	L60 x W60 x H40 mm
Distancia / Distance / Distanza	30 m
Temperatura de trabajo / Working Temperature / Température de fonctionnement / Temperatura di lavoro	-20°C~+55°C
Precio / Price / Prix / Prezzo	229,95€



88577

0/1-10V



Controlador CASAMBI Bluetooth regulación + Rf 0/1-10v / CASAMBI Bluetooth Controller with Dimming + RF 0/1-10V / Contrôleur CASAMBI Bluetooth avec gradation + RF 0/1-10 V / Controller CASAMBI Bluetooth con regolazione + RF 0/1-10 V



Control / Input signal / Signal d'entrée / Controllo	RF 2.5GHz + Push Dim
Voltaje de entrada / Input Voltage / Tension d'entrée / Tensione d'ingresso	AC 100-240VAC
Tensión de salida / Output Voltage / Tension de sortie / Tensione di uscita	0/1-10V
Corriente de salida / Output Current / Courant de sortie / Corrente di uscita	Max 3A
Potencia de salida / Output Power / Puissance de sortie / Potenza in uscita	360W
Tamaño / Size / Taille / Dimensione	L60 x W60 x H40 mm
Distancia / Distance / Distanza	30 m
Temperatura de trabajo / Working Temperature / Température de fonctionnement / Temperatura di lavoro	-20°C~+50°C
Precio / Price / Prix / Prezzo	199,95€



Controlador de luz de escalera con sensor PIR / Stairway light controller with PIR sensor / Contrôleur d'éclairage d'escalier avec détecteur PIR / Regolatore di luce per scale con sensore PIR



Voltaje de entrada / Input Voltage / Tension d'entrée / Tensione d'ingresso	5-24VDC
Tensión de salida / Output Voltage / Tension de sortie / Tensione di uscita	32x(5-24)VDC
Corriente de salida / Output Current / Courant de sortie / Corrente di uscita	32 CH, 1A/CH
Potencia de salida / Output Power / Puissance de sortie / Potenza in uscita	32x24W
Tamaño / Size / Taille / Dimensione	L186 x W86 x H25 mm
Temperatura de trabajo / Working Temperature / Température de fonctionnement / Temperatura di lavoro	-30°C~+55°C
Precio / Price / Prix / Prezzo	239,95€

88530



SMART DRIVER regulable 15A / Dimmable smart driver 15A / Dimmable driver intelligent 15A / SMART DRIVER regolabile 15A



Control / Input signal / Signal d'entrée / Controllo	RF 2.4GHz + Push Dim
Voltaje de entrada / Input Voltage / Tension d'entrée / Tensione d'ingresso	100-265VAC
Tensión de salida / Output Voltage / Tension de sortie / Tensione di uscita	10-45VDC
Corriente de salida / Output Current / Courant de sortie / Corrente di uscita	150-700mA
Potencia de salida / Output Power / Puissance de sortie / Potenza in uscita	Max 15W
Tamaño / Size / Taille / Dimensione	L51 x W41 x H30 mm
Distancia / Distance / Distanza	30 m
Temperatura de trabajo / Working Temperature / Température de fonctionnement / Temperatura di lavoro	-30°C~+55°C
Precio / Price / Prix / Prezzo	39,95€

88532



SMART DRIVER regulable 36A / Dimmable smart driver 36A / Dimmable driver intelligent 36A / SMART DRIVER regolabile 36A



Control / Input signal / Signal d'entrée / Controllo	RF 2.4GHz + Push Dim
Voltaje de entrada / Input Voltage / Tension d'entrée / Tensione d'ingresso	100-265VAC
Tensión de salida / Output Voltage / Tension de sortie / Tensione di uscita	10-52VDC
Corriente de salida / Output Current / Courant de sortie / Corrente di uscita	350-1200mA
Potencia de salida / Output Power / Puissance de sortie / Potenza in uscita	Max 36W
Tamaño / Size / Taille / Dimensione	L168.5 x W44 x H30 mm
Distancia / Distance / Distanza	30 m
Temperatura de trabajo / Working Temperature / Température de fonctionnement / Temperatura di lavoro	-30°C~+55°C
Precio / Price / Prix / Prezzo	59,95€

88533



SMART DRIVER regulable 50A / Dimmable smart driver 50A / Dimmable driver intelligent 50A / SMART DRIVER regolabile 50A



Control / Input signal / Signal d'entrée / Controllo	RF 2.4GHz + Push Dim
Voltaje de entrada / Input Voltage / Tension d'entrée / Tensione d'ingresso	100-265VAC
Tensión de salida / Output Voltage / Tension de sortie / Tensione di uscita	10-52VDC
Corriente de salida / Output Current / Courant de sortie / Corrente di uscita	500-1750mA
Potencia de salida / Output Power / Puissance de sortie / Potenza in uscita	Max 50W
Tamaño / Size / Taille / Dimensione	L133 x W88 x H30 mm
Distancia / Distance / Distanza	30 m
Temperatura de trabajo / Working Temperature / Température de fonctionnement / Temperatura di lavoro	-30°C~+55°C
Precio / Price / Prix / Prezzo	79,95€

88540



Sensor ON-OFF + Dimmer para tira LED / ON-OFF + Dimmer sensor for LED strip / Détecteur ON-OFF + Dimmer pour bande LED / Sensore ON-OFF + dimmer per striscia LED



Control / Input signal / Signal d'entrée / Controllo	Touch Key
Voltaje de entrada / Input Voltage / Tension d'entrée / Tensione d'ingresso	12-24VDC
Tensión de salida / Output Voltage / Tension de sortie / Tensione di uscita	12-24VDC
Corriente de salida / Output Current / Courant de sortie / Corrente di uscita	Constant Voltage
Potencia de salida / Output Power / Puissance de sortie / Potenza in uscita	Max 75W
Tamaño / Size / Taille / Dimensione	L50 x W7.80 x H10mm
Rango dimable / Dimmable range / Gamme gradable / Gamma dimmerabile	0-100%
Temperatura de trabajo / Working Temperature / Température de fonctionnement / Temperatura di lavoro	-30°C~+55°C
Precio / Price / Prix / Prezzo	15,95€

88541



Sensor de puertas / Door sensor / Détecteur de porte / Sensore porta



Control / Input signal / Signal d'entrée / Controllo	RF 2.4GHz
Voltaje de entrada / Input Voltage / Tension d'entrée / Tensione d'ingresso	12-24VDC
Tensión de salida / Output Voltage / Tension de sortie / Tensione di uscita	12-24VDC
Potencia de salida / Output Power / Puissance de sortie / Potenza in uscita	Max 48W@12V / Max 96W@24V
Tamaño / Size / Taille / Dimensione	L50 x W11 x H7.5 mm
Temperatura de trabajo / Working Temperature / Température de fonctionnement / Temperatura di lavoro	-30°C~+55°C
Precio / Price / Prix / Prezzo	16,95€

88542



Sensor de movimiento para perfil / Motion sensor for profile / Détecteur de mouvement pour profil / Sensore di movimento per il profilo



Control / Input signal / Signal d'entrée / Controllo	RF 2.4GHz
Voltaje de entrada / Input Voltage / Tension d'entrée / Tensione d'ingresso	12-24VDC
Tensión de salida / Output Voltage / Tension de sortie / Tensione di uscita	12-24VDC
Campo sensibilidad sensor / Sensivity field sensor / Capteur de champ de sensibilité / Campo di sensibilità del sensore	< 3m
Ángulo sensibilidad sensor / Sensivity angle sensor / Capteur d'angle de sensibilité / Angolo di sensibilità del sensore	120°
Potencia de salida / Output Power / Puissance de sortie / Potenza in uscita	Max 36W@12V / Max 72W@24V
Tamaño / Size / Taille / Dimensione	L50 x W11 x H12 mm
Temperatura de trabajo / Working Temperature / Température de fonctionnement / Temperatura di lavoro	-30°C~+55°C
Precio / Price / Prix / Prezzo	18,95€

88515



Mando 1 zona / 1 zone remote / Télécommande 1 zone / Telecomando 1 zona



Control / Input signal / Signal d'entrée / Controllo	RF (2.4GHz)
Tensión de trabajo / Controls working voltage / Tension de fonctionnement / Tensione di funzionamento	3VDC/CR2032
Tamaño / Size / Taille / Dimensione	L100 x W47 x H8 mm
Distancia / Distance / Distanza	30 m
Temperatura de trabajo / Working Temperature / Température de fonctionnement / Temperatura di lavoro	-30°C~+55°C
Precio / Price / Prix / Prezzo	22,95€

88516



Mando 1 zona / 1 zone remote / Télécommande 1 zone / Telecomando 1 zona



Control / Input signal / Signal d'entrée / Controllo	RF (2.4GHz)
Tensión de trabajo / Controls working voltage / Tension de fonctionnement / Tensione di funzionamento	3VDC/CR2032
Tamaño / Size / Taille / Dimensione	L139 x W36 x H11 mm
Distancia / Distance / Distanza	30 m
Temperatura de trabajo / Working Temperature / Température de fonctionnement / Temperatura di lavoro	-30°C~+55°C
Precio / Price / Prix / Prezzo	38,95€

88570



Control inalámbrico dimer 1 zona (pulsador) / Wireless control dimmer 1 zone (pushbutton) / Commande sans fil dimmer 1 zone (bouton-poussoir) / Controllo dimmer wireless a 1 zona (pulsante)



Control / Input signal / Signal d'entrée / Controllo	RF (2.4GHz)
Tensión de trabajo / Controls working voltage / Tension de fonctionnement / Tensione di funzionamento	3VDC/CR2032
Tamaño / Size / Taille / Dimensione	L17 x W43 x H17 mm
Distancia / Distance / Distanza	30 m
Temperatura de trabajo / Working Temperature / Température de fonctionnement / Temperatura di lavoro	-30°C~+55°C
Precio / Price / Prix / Prezzo	36,95€

88571



Control inalámbrico dimer 1 zona (pulsador) / Wireless control dimmer 1 zone (pushbutton) / Commande sans fil dimmer 1 zone (bouton-poussoir) / Controllo dimmer wireless a 1 zona (pulsante)



Control / Input signal / Signal d'entrée / Controllo	RF (2.4GHz)
Tensión de trabajo / Controls working voltage / Tension de fonctionnement / Tensione di funzionamento	3VDC/CR2032
Tamaño / Size / Taille / Dimensione	L17 x W43 x H17 mm
Distancia / Distance / Distanza	30 m
Temperatura de trabajo / Working Temperature / Température de fonctionnement / Temperatura di lavoro	-30°C~+55°C
Precio / Price / Prix / Prezzo	36,95€

88507



Mando monocolor 4 zonas / 4 zone single color remote / Télécommande unicolore à 4 zones / Controllo unicolore 4 zone



Control / Input signal / Signal d'entrée / Controllo	RF (2.4GHz)
Tensión de trabajo / Controls working voltage / Tension de fonctionnement / Tensione di funzionamento	3VDC/CR2032
Tamaño / Size / Taille / Dimensione	L107 x W58.5 x H9 mm
Distancia / Distance / Distanza	30 m
Temperatura de trabajo / Working Temperature / Température de fonctionnement / Temperatura di lavoro	-30°C~+55°C
Precio / Price / Prix / Prezzo	35,95€

88508



Mando monocolor 4 zonas / 4 zone single color remote / Télécommande unicolore à 4 zones / Controllo unicolore 4 zone



Control / Input signal / Signal d'entrée / Controllo	RF (2.4GHz)
Tensión de trabajo / Controls working voltage / Tension de fonctionnement / Tensione di funzionamento	3VDC/CR2032
Tamaño / Size / Taille / Dimensione	L135 x W40 x H11 mm
Distancia / Distance / Distanza	30 m
Temperatura de trabajo / Working Temperature / Température de fonctionnement / Temperatura di lavoro	-30°C~+55°C
Precio / Price / Prix / Prezzo	37,95€

88509



Mando RGB+RGBW 4 zonas / RGB+RGBW remote 4 zones / Télécommande RGB+RGBW 4 zones / Telecomando RGB+RGBW 4 zone (pulsante)



Control / Input signal / Signal d'entrée / Controllo	RF (2.4GHz)
Tensión de trabajo / Controls working voltage / Tension de fonctionnement / Tensione di funzionamento	3VDC/CR2032
Tamaño / Size / Taille / Dimensione	L107 x W58.5 x H9 mm
Distancia / Distance / Distanza	30 m
Temperatura de trabajo / Working Temperature / Température de fonctionnement / Temperatura di lavoro	-30°C~+55°C
Precio / Price / Prix / Prezzo	49,95€

88513



Mando RGB+CCT 4 zonas / RGB+CCT remote 4 zones / Télécommande RGB+CCT 4 zones / Telecomando RGB+CCT 4 zone



Control / Input signal / Signal d'entrée / Controllo	RF (2.4GHz)
Tensión de trabajo / Controls working voltage / Tension de fonctionnement / Tensione di funzionamento	3VDC(AAAx2)
Tamaño / Size / Taille / Dimensione	L122 x W53 x H17.5 mm
Distancia / Distance / Distanza	30 m
Temperatura de trabajo / Working Temperature / Température de fonctionnement / Temperatura di lavoro	-30°C~+55°C
Precio / Price / Prix / Prezzo	51,95€

88585



Panel control táctil pared 4 zonas RGB+CCT / Tactile wall mounted panel RGB+CCT 4 zones / Panneau de commande tactile mural 4 zones RGB+CCT / Pannello di controllo tattile a parete 4 zone RGB+CCT



Control / Input signal / Signal d'entrée / Controllo	Touch key + RF (2.4GHz)
Voltaje de entrada / Input Voltage / Tension d'entrée / Tensione d'ingresso	100-240VAC
Salida de señal / Output signal / Sortie de signal / Segnale in uscita	DMX 512, RF 2.4 GHz
Tamaño / Size / Taille / Dimensione	L112 x W112 x H50 mm
Temperatura de trabajo / Working Temperature / Température de fonctionnement / Temperatura di lavoro	-30°C~+55°C
Precio / Price / Prix / Prezzo	89,95€

88586



Panel control táctil pared 4 zonas RGBW / Tactile wall mounted panel RGBW 4 zones / Panneau de commande tactile mural 4 zones RGBW / Pannello di controllo tattile a parete 4 zone RGBW



Control / Input signal / Signal d'entrée / Controllo	Touch key + RF (2.4GHz)
Voltaje de entrada / Input Voltage / Tension d'entrée / Tensione d'ingresso	100-240VAC
Salida de señal / Output signal / Sortie de signal / Segnale in uscita	DMX 512, RF 2.4 GHz
Tamaño / Size / Taille / Dimensione	L112 x W112 x H50 mm
Temperatura de trabajo / Working Temperature / Température de fonctionnement / Temperatura di lavoro	-30°C~+55°C
Precio / Price / Prix / Prezzo	89,95€

88510



Pulsador inalámbrico monocolor 2 zonas / Wireless single-color 2-zone push button / Bouton wireless unicolor 2 zones / Pulsante wireless monocolor 2 zone



Control / Input signal / Signal d'entrée / Controllo	RF (2.4GHz)
Tensión de trabajo / Controls working voltage / Tension de fonctionnement / Tensione di funzionamento	3VDC(AAAx2)
Tamaño / Size / Taille / Dimensione	L86 x W86 x H14 mm
Distancia / Distance / Distanza	30 m
Temperatura de trabajo / Working Temperature / Température de fonctionnement / Temperatura di lavoro	-30°C~+55°C
Precio / Price / Prix / Prezzo	34,95€

88511



Pulsador inalámbrico RGB / RGB wireless pushbutton / Bouton wireless RGB / Pulsante RGB wireless



Control / Input signal / Signal d'entrée / Controllo	RF (2.4GHz)
Tensión de trabajo / Controls working voltage / Tension de fonctionnement / Tensione di funzionamento	3VDC(AAAx2)
Tamaño / Size / Taille / Dimensione	L86 x W86 x H14 mm
Distancia / Distance / Distanza	30 m
Temperatura de trabajo / Working Temperature / Température de fonctionnement / Temperatura di lavoro	-30°C~+55°C
Precio / Price / Prix / Prezzo	37,95€

88512



Central Wifi / Wifi center / Centre Wi-fi / Wifi centrale



WiFi-Relay

Control / Input signal / Signal d'entrée / Controllo	DC5-24V, 300 mA
Estándar inalámbrico / Wireless standard / Norme sans fil / Standard wireless	802.11 B7g7N
Rango de frecuencia / Frequency range / Gamme de fréquences / Gamma di frequenza	2.412GHz~2.484GH
Tamaño / Size / Taille / Dimensione	72x25 mm
Distancia / Distance / Distanza	30 m
Precio / Price / Prix / Prezzo	69,95€

Guía de composición / Composition guide

TIRAS Y NEÓN 24V MONOCOLOR / STRIPS AND NEON 24V MONOCOLOUR / BANDES ET NÉONS 24V MONOCOLORE / STRISCE E NEON 24V MONOCOLORE

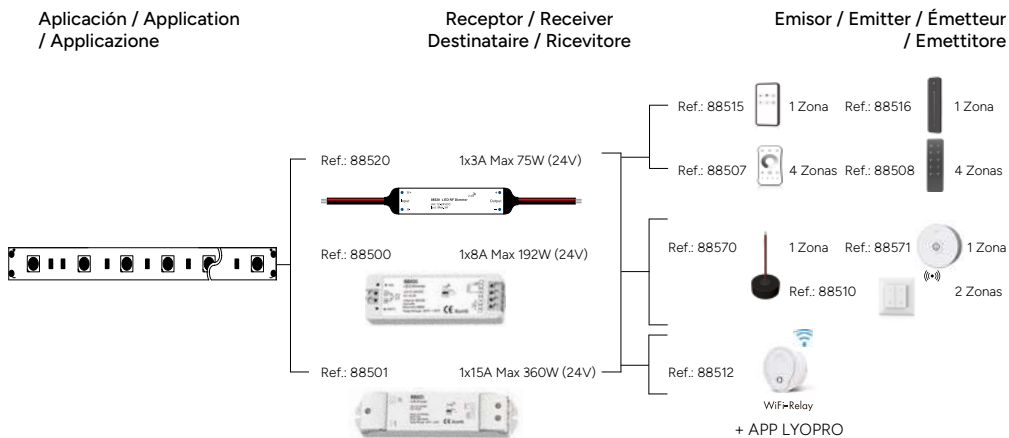

TIRAS Y NEÓN 24V RGB / STRIPS AND NEON 24V RGB / BANDES ET NÉONS 24V RGB / STRISCE E NEON 24V RGB

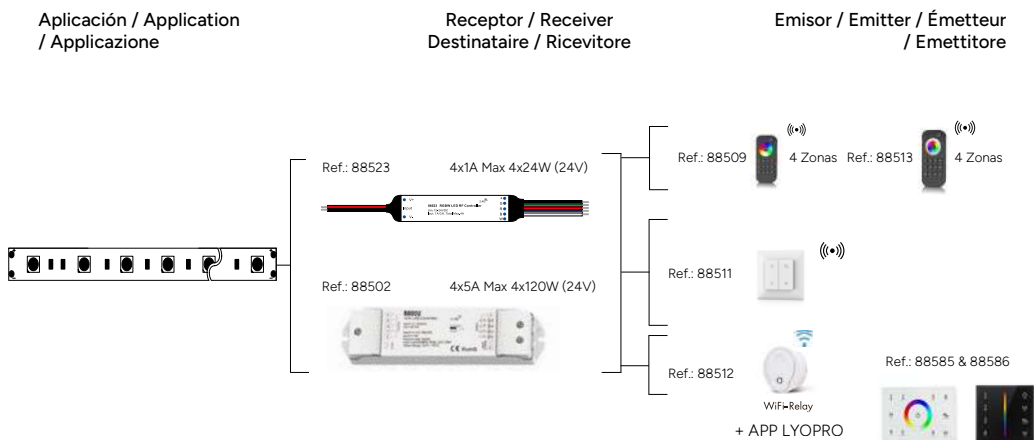

Guide de composition / Guida alla composizione

TIRAS Y NEÓN 24V RGB+CCT / STRIPS AND NEON 24V RGB+CCT / BANDES ET NÉONS 24V RGB+CCT / STRISCE E NEON 24V RGB+CCT

Aplicación / Application
/ Applicazione

Receptor / Receiver
Destinatario / Ricevitore

Emisor / Emitter / Émetteur
/ Emittitore



TIRAS 24V CCT (TUNABLE WHITE) / STRIPS 24V CCT (TUNABLE WHITE) / BANDES 24V CCT (TUNABLE WHITE) / STRISCE 24V CCT (BIANCO SINTONIZZABILE)

Aplicación / Application
/ Applicazione

Receptor / Receiver
Destinatario / Ricevitore

Emisor / Emitter / Émetteur
/ Emittitore

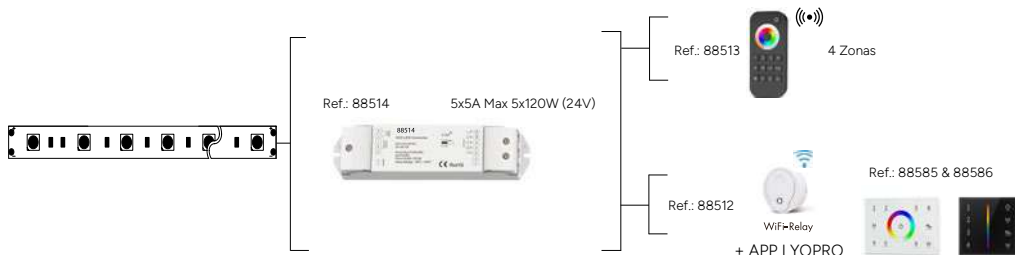

Guía de composición / Composition guide

TIRAS Y NEÓN 230V MONOCOLOR / STRIPS AND NEON 230V MONOCOLOUR / BANDES ET NÉONS 230V MONOCOLORE / STRISCE E NEON 230V MONOCOLORE

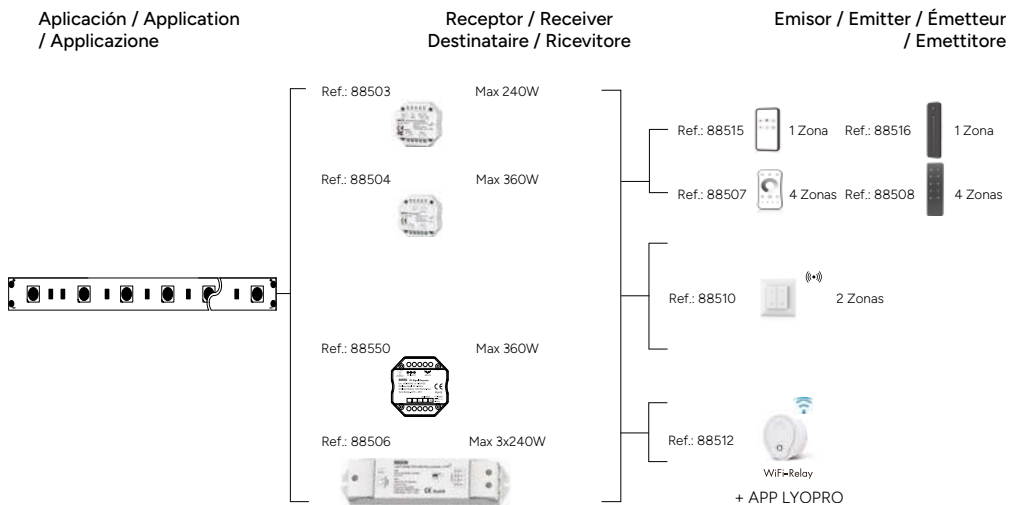

TIRAS 230V RGB / STRIPS 230V RGB / BANDES 230V RGB / STRISCE 230V RGB

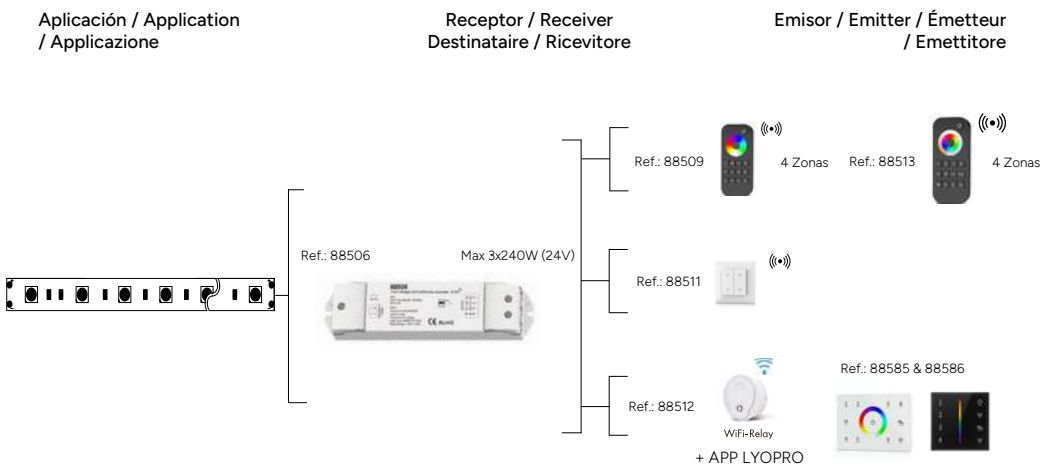

Guía de composición / Composition guide

TIRAS 48V MONOCOLOR / 48V MONOCOLOR LED STRIPS / BANDES LED 48V MONOCOULEUR / STRISCE LED 48V MONOCOLORE

Aplicación / Application
/ Applicazione

Receptor / Receiver
Destinatario / Ricevitore

Emisor / Emitter / Émetteur
/ Emittitore

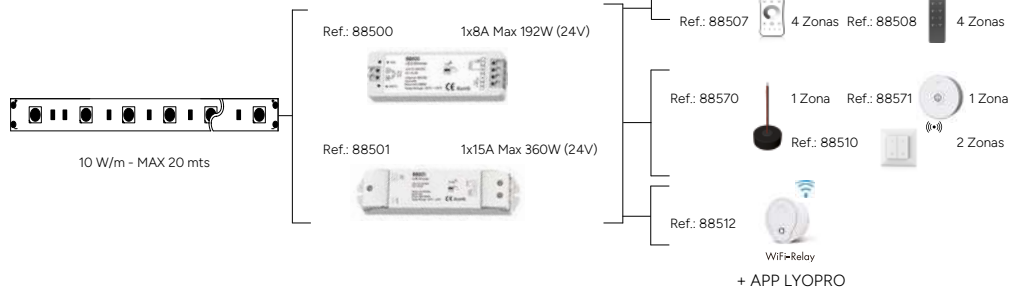

Servicio de corte a medida / Cut to size service

ES_ Servicio que disponemos para nuestros clientes donde les ofrecemos la posibilidad de realizar la manipulación necesaria ya sean cortes tanto en tiras como en perfilería o soldaduras, para conseguir un nivel óptimo de acabado en nuestras tiras según la exigencia de la obra. **EN_** Service that we have for our clients where we offer them the possibility of carrying out the necessary manipulation, whether it is cuts in strips, profiles or welds, to achieve an optimal level of finish in our strips according to the requirements of the work. **FR_** Service que nous avons pour nos clients où nous leur offrons la possibilité d'effectuer les manipulations nécessaires, qu'il s'agisse de coupes en bandes, de Profils ou de soudures, pour obtenir un niveau de finition optimal de nos bandes selon les exigences du travail. **IT_** Offriamo ai nostri clienti la possibilità di effettuare le manipolazioni necessarie, che si tratti di tagli in strisce, profili o saldature, per ottenere un livello di finitura ottimale dei nostri nastri in base alle esigenze del progetto.

Soldadura monocolor inicio+20cm cable / Monocolor soldering start+20cm wire / Début de soudage monochrome+20cm fil / Inizio di saldatura monocolor+filo da 20 cm	90020	4,45€
Soldadura monocolor inicio+50cm cable / Monocolor soldering start+50cm wire / Début de soudage monochrome+50cm fil / Avvio di saldatura monocolor+cavo da 50cm	90021	4,75€
Soldadura monocolor inicio+1m cable / Monocolor soldering start+1m wire / Début de soudage monochrome+1m fil / Avvio di saldatura monocolor+1m di cavo	90022	4,95€
Soldadura monocolor inicio+2m cable / Monocolor soldering start+2m wire / Début de soudage monochrome+2m fil / Avvio di saldatura monocolor+2m di cavo	90029	6,75€
Soldadura monocolor inicio+3m cable / Monocolor soldering start+3m wire / Début de soudure monochrome+3m fil / Avvio di saldatura monocolor+3m di cavo	90030	7,95€
Soldadura monocolor inicio+4m cable / Monocolor soldering start+4m wire / Début de soudage monochrome+4m fil / Avvio di saldatura monocolor+4m di cavo	90031	8,95€
Soldadura monocolor inicio+5m cable / Monocolor soldering start+5m wire / Début de soudage monochrome+5m fil / Avvio di saldatura monocolor+5m di cavo	90032	10,95€
Soldadura empalme monocolor / Single color joint weld / Soudure unicolore / Saldatura monocolor	90023	5,95€
Soldadura RGB/RGBW inicio + 20cm cable / RGB/RGBW soldering start + 20cm wire / Début de soudage RGB/RGBW + 20cm fil / RGB/RGBW inizio saldatura + cavo da 20 cm	90024	6,75€
Soldadura RGB/RGBW inicio + 50cm cable / RGB/RGBW soldering start + 50cm wire / Début de soudage RGB/RGBW + 50cm fil / RGB/RGBW inizio saldatura + cavo da 50 cm	90025	6,95€
Soldadura RGB/RGBW inicio + 1m cable / RGB/RGBW soldering start + 1m wire / Début de soudage RGB/RGBW + 1m fil / RGB/RGBW inizio saldatura + cavo da 1 m	90026	7,75€
Soldadura RGB/RGBW inicio + 2m cable / RGB/RGBW soldering start + 2m wire / Début de soudage RGB/RGBW + 2m fil / RGB/RGBW inizio saldatura + cavo da 2 m	90033	8,95€
Soldadura RGB/RGBW inicio + 3m cable / RGB/RGBW soldering start + 3m wire / Début de soudage RGB/RGBW + 3m fil / RGB/RGBW inizio saldatura + cavo da 3 m	90034	10,95€
Soldadura RGB/RGBW inicio + 4m cable / RGB/RGBW soldering start + 4m wire / Début de soudage RGB/RGBW + 4m fil / RGB/RGBW inizio saldatura + cavo da 4 m	90035	12,95€
Soldadura RGB/RGBW inicio + 5m cable / RGB/RGBW soldering start + 5m wire / Début de soudage RGB/RGBW + 5m fil / RGB/RGBW inizio saldatura + cavo da 5 m	90036	13,95€
Soldadura empalme RGB/RGBW / RGB/RGBW solder joint / Joint de soudage RVB/RGBW / Saldatura di giunzioni RGB/RGBW	90027	10,95€

Service de coupe sur mesure / Servizio di taglio a misura

ES_ Si necesitas opciones especiales o personalizadas, ¡consúltanos y encontraremos la mejor solución para ti. **EN_** If you need special or customised options, contact us and we will find the best solution for you. **FR_** Si vous avez besoin d'options spéciales ou personnalisées, contactez-nous et nous trouverons la meilleure solution pour vous. **IT_** Se avete bisogno di opzioni speciali o personalizzate, contattateci e troveremo la soluzione migliore per voi.

Corte de perfil aluminio / Aluminum profile cutting / Coupe de profilé en aluminium / Taglio di profili in alluminio	90028	3,95€
Montaje perfil TURIN / TURIN profile mounting / Montage du profilé TURIN / Montaggio del profilo TURIN	90060	32,95€
Montaje perfil ESSEN / ESSEN profile mounting / Montage du profilé ESSEN / Montaggio del profilo ESSEN	90061	33,95€
Montaje perfil suspensión / Suspension profile assembly / Assemblage du profilé de suspension / Montaggio del profilo di sospensione	90062	10,95€
Montaje sensor on/off y sensor puertas / Assembly of on/off sensor and door sensor / Assemblage du capteur marche/arrêt et du capteur de porte / Montaggio del sensore on/off e del sensore porta	90070	8,95€
Montaje sensor de movimiento / Motion Sensor Mount / Support de capteur de mouvement / Montaggio del sensore di movimento	90071	10,95€
Montaje perfil + difusor completo / Profile assembly + complete diffuser / Ensemble profilé + diffuseur complet / Profilo + gruppo diffusore completo	90072	10,95€
Montaje HADES / HADES Assembly / Assemblage HADES / Assemblaggio HADES	90076	29,95€

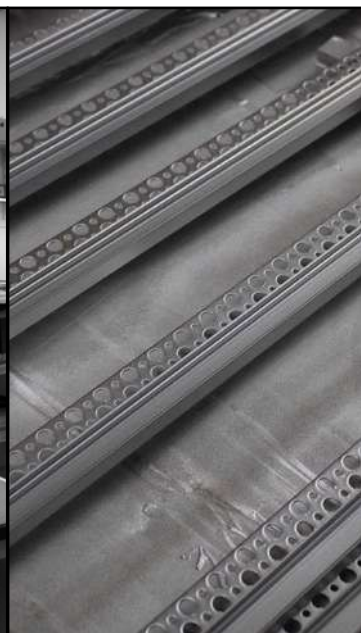

Expositores / Exhibitors

LightPoint:

ES_ Conoce nuestros expositores, una herramienta para mostrar las distintas opciones que ofrecemos.

EN_ Get to know our displays, a tool to show the different options we offer.

FR_ Découvrez nos présentoirs, un outil pour montrer les différentes options que nous offrons.

IT_ Conoscete i nostri espositori, uno strumento per mostrare le diverse opzioni che offriamo.

Catalog Corner

ES_ Presente nuestro catálogo en cualquier punto de venta. Su diseño vertical fabricado en acero inoxidable optimiza el espacio sin perder visibilidad.

EN_ Present our catalogue at any point of sale. Its vertical design made of stainless steel optimises space without losing visibility.

FR_ Présenter notre catalogue dans tous les points de vente. Son design vertical en acier inoxydable permet d'optimiser l'espace sans perdre en visibilité.

IT_ Presenta il nostro catalogo in qualsiasi punto vendita. Il suo design verticale in acciaio inossidabile ottimizza lo spazio senza perdere visibilità.

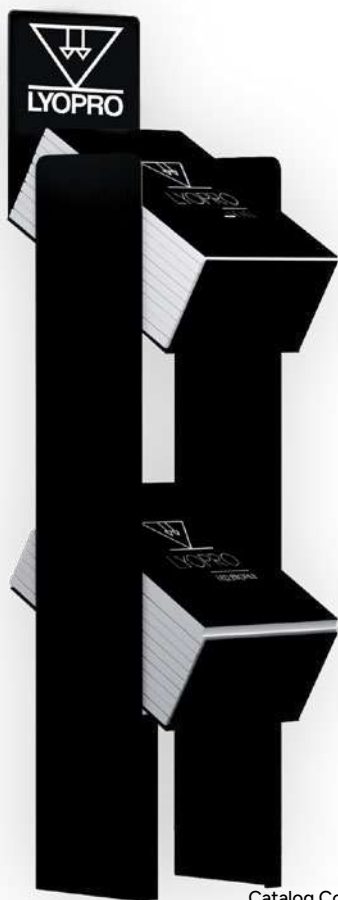

Catalog Corner

W331.55*L55*H1000 mm



Profile Showcase

W 310*L444*H110 mm

Catalog Corner

ES_ Explora nuestra gama de perfiles con el maletín que contiene un perfil de cada diseño, permitiéndote ver y tocar las opciones disponibles de manera práctica y accesible.

EN_ Explore our range of profiles with the case containing a profile of each design, allowing you to see and touch the available options in a practical and accessible way.

FR_ Découvrez notre gamme de profilés grâce à la mallette contenant un profilé de chaque modèle, qui vous permet de voir et de toucher les options disponibles d'une manière pratique et accessible.

IT_ Esplorate la nostra gamma di profili con la valigetta che contiene un profilo di ogni design, permettendovi di vedere e toccare le opzioni disponibili in modo pratico e accessibile.

Light Box

ES_ Diseñado para mostrar y trabajar cómodamente con nuestras tiras LED, cuenta con 3 soportes para colocar las tiras de manera ordenada y accesible. Fabricado en madera para facilitar su transporte y manipulación.

EN_ Designed to work comfortably with our LED strips, made of wood, its structure has 3 supports to place the strips in an orderly and accessible way.

FR_ Conçue pour fonctionner confortablement avec nos bandes LED, en bois, sa structure comporte 3 supports pour placer les bandes de manière ordonnée et accessible.

IT_ Progettata per lavorare comodamente con le nostre strisce LED, realizzata in legno, la sua struttura è dotata di 3 supporti per posizionare le strisce in modo ordinato e accessibile.



Light Box

W310*L460*H1045 mm

Condiciones de venta

FORMALIZAR UN PEDIDO IMPLICA LA ACEPTACIÓN DE ESTAS CONDICIONES DE VENTA GENERALES.

Todas las ventas se realizan bajo las condiciones relacionadas a continuación. Cualquier especificación que no se ajuste a estas condiciones tendrá que ser antes aceptada por escrito por LYOPRO.

PRESUPUESTOS. Los presupuestos tendrán una validez máxima de 30 días naturales desde la fecha de su emisión.

GARANTÍA Y CALIDAD. Todos los productos de LYOPRO están garantizados contra defectos de fabricación, pero no cubren daños por uso indebido, manipulación incorrecta o instalación inapropiada. La garantía tampoco cubre el desgaste normal o daños causados por personal no autorizado. Las pequeñas diferencias en tamaño, color o calidad no son motivo de reclamación. Cualquier reclamación debe comunicarse dentro de las 48 horas de recibir el material. Para ejecutar la garantía, es necesario devolver el material para su análisis, presentar la factura y completar el formulario RMA. LYOPRO se reserva el derecho de modificar sus productos sin previo aviso.

PLAZO DE ENTREGA. Los plazos de entrega son aproximados y no garantizados, y LYOPRO no se responsabiliza por daños o indemnizaciones por demoras. El incumplimiento del plazo no permite la rescisión del contrato sin un plazo adicional para resolver la demora. Las causas de fuerza mayor (guerras, huelgas, catástrofes naturales, roturas de maquinaria, moldes o matrices, imposibilidad de adquisición de materia prima, interrupción del transporte, cierre de aduanas o cualquier otra medida oficial que pudiera afectar) pueden retrasar la entrega sin previo aviso. Cada envío se considera una expedición independiente, incluso si forman parte de un mismo pedido.

PRECIOS / PORTES. Serán los establecidos en nuestra web a excepción de acuerdos explícitos confirmados por LYOPRO. **PORTES:** Condiciones válidas únicamente en territorio peninsular español. Portes pagados a partir de 200€ y en perfiles LED PROFILE de hasta 2 metros de longitud. Islas Canarias: Portes pagados a partir de 600€ y en perfiles LED PROFILE de hasta 2 metros de longitud. Debido a errores de imprenta, evolución de los productos o a las constantes fluctuaciones de la materia prima, LYOPRO se reserva el derecho de variar los precios sin previo aviso. Perfiles de más de 2 metros, tendrá un coste adicional de 15 euros por expedición.

PEDIDOS. Todos los pedidos de material cortado o manipulado deben confirmarse por escrito antes de procesarlos. Para pedidos superiores a 1.500€, se requiere un 50% de pago por adelantado. LYOPRO no se hace responsable de pedidos no confirmados por escrito. Los pedidos con pago por transferencia no se procesarán hasta recibir el comprobante de pago.

ANULACIONES-DEVOLUCIONES DE PEDIDOS. No se aceptan devoluciones pasados 15 días desde la entrega. Los pedidos firmes no pueden ser anulados sin la aprobación de LYOPRO. Las devoluciones por causas ajenas a LYOPRO tienen un cargo del 20% (mínimo 10€). Las devoluciones solo se aceptan con autorización de LYOPRO y la hoja de devolución cumplimentada. Las devoluciones a portes debidos no son aceptadas, salvo error de LYOPRO. No se aceptan devoluciones de productos fabricados a medida o personalizados.

RESERVA DE PROPIEDAD. La mercancía suministrada queda en nuestra total propiedad hasta su pago. El derecho de propiedad subsiste aún después de que el comprador haya revendido el producto, hasta que no haya cancelado la deuda con LYOPRO.

TRANSPORTE. Cualquier anomalía en el material o incidencias de transporte deben ser registradas en el albarán al recibir la mercancía. El cliente debe informar de la incidencia dentro de las 24 horas posteriores a la entrega. Es responsabilidad del cliente gestionar reclamaciones con los transportistas por pérdida, daño o retraso. Si no se indican instrucciones especiales de envío, LYOPRO elegirá el transporte.

PAGO. Las condiciones de pago serán las acordadas con nuestros clientes. Los vencimientos de los pagos mediante cualquier documento de pago legalmente aceptado, deberán de respetarse puntualmente. En caso contrario estamos facultados a cargar los intereses de demora, así como los quebrantos ocasionados por la demora en el pago. Las demoras en el pago traen consigo con efecto inmediato la anulación de todos los compromisos de LYOPRO para con el cliente. El comprador no está autorizado a retener la totalidad a parte de los pagos vencidos por no habersele reconocido alguna reclamación, ya que ésta no le exime de su compromiso de pago. Todo impagado o retraso en el pago anula la posibilidad del crédito, paralizando el suministro de materiales en tanto no se regularice la situación. Si esta situación fuera repetitiva, se procederá a comunicarlo a CRÉDITO & CAUCIÓN cancelándose el crédito de forma irrevocable.

FUERO. Para cuantas cuestiones y discrepancias se deriven de la presente operación, comprador y vendedor se someten expresamente a la competencia de los jueces y tribunales de los Juzgados de Valencia con renuncia a cualquier otro fuero propio o reserva de dominio que pudiera corresponder.

COSTAS Y GASTOS. Los gastos y costas judiciales, incluso honorarios de Abogado y derechos de Procurador, serán siempre por cuenta de la parte contratante que hubiera dado lugar a ellos por incumplimiento de estas condiciones generales de venta o del contrato en general.

DERECHO SUPLETORIO. El presente contrato de venta se regirá por lo aquí convenido y en su defecto por las normas del Código de Comercio Español para las ventas en España.

Terms and conditions of sale

PLACING AN ORDER IMPLIES ACCEPTANCE OF THESE GENERAL TERMS AND CONDITIONS OF SALE.

All sales are made under the conditions listed below. Any specification which does not conform to these conditions must first be accepted in writing by LYOPRO.

QUOTATIONS. Quotations shall be valid for a maximum of 30 calendar days from the date of issue.

WARRANTY AND QUALITY. All LYOPRO products are warranted against manufacturing defects, but do not cover damage due to misuse, mishandling or improper installation. The warranty also does not cover normal wear and tear or damage caused by unauthorised personnel. Minor differences in size, colour or quality are not grounds for complaint. Any claims must be reported within 48 hours of receipt of the material. To execute the warranty, it is necessary to return the material for analysis, present the invoice and complete the RMA form. LYOPRO reserves the right to modify its products without prior notice.

DELIVERY TIME: Delivery times are approximate and not guaranteed, and LYOPRO is not responsible for damages or compensation due to delays. Failure to meet the delivery deadline does not allow the customer to cancel the contract without an additional period to resolve the delay. Force majeure events (wars, strikes, natural disasters, machinery breakdowns, molds or dies, inability to acquire raw materials, transportation interruptions, customs closures, or any other official measure that may affect) may delay delivery without prior notice. Each shipment is considered an independent expedition, even if part of the same order.

PRICES / SHIPPING: Prices will be as listed on our website, except for explicit agreements confirmed by LYOPRO. Shipping conditions apply only in mainland Spain. Free shipping on orders over 200€ for LED profiles up to 2 meters long. Canary Islands: Free shipping on orders over 600€ for LED profiles up to 2 meters long. Due to printing errors, product evolution, or fluctuations in raw materials, LYOPRO reserves the right to change prices without prior notice. Profiles longer than 2 meters will incur an additional charge of 15 euros per shipment.

ORDERS: All orders for cut or processed materials must be confirmed in writing before processing. For orders over 1,500€, a 50% advance payment is required. LYOPRO is not responsible for orders not confirmed in writing. Orders paid via bank transfer will not be processed until payment proof is received.

CANCELLATIONS-RETURNS: Returns are not accepted after 15 days from delivery. Firm orders cannot be canceled without LYOPRO's approval. Returns due to reasons not related to LYOPRO will incur a 20% restocking fee (minimum 10€). Returns are only accepted with LYOPRO's authorization and a completed return form. Returns with charges to the customer are not accepted, except for LYOPRO's error. Custom-made or personalized products cannot be returned.

RESERVATION OF OWNERSHIP: The supplied goods remain the property of LYOPRO until full payment is made. The right of ownership continues even if the buyer resells the product, until the debt is fully paid to LYOPRO.

TRANSPORT: Any anomalies in the materials or transport incidents must be recorded on the delivery note at the time of receipt. The customer must report any issues within 24 hours after delivery. It is the customer's responsibility to handle claims with the transporters for loss, damage, or delay. If no special shipping instructions are provided, LYOPRO will select the transport method.

PAYMENT: Payment terms will be as agreed with the customer. Payments must be made on time according to any legally accepted payment document. In case of delay, LYOPRO is entitled to charge interest for late payments, as well as any losses caused by the delay. Late payments immediately cancel all commitments from LYOPRO to the customer. The buyer is not authorized to withhold any payments due to unrecognized claims, as this does not exempt them from their payment obligations. Any unpaid or delayed payment will cancel credit opportunities and suspend material supply until the situation is resolved. Repeated non-payment will be reported to CREDIT & CAUTION, and credit will be irrevocably canceled.

JURISDICTION: For any issues or disputes arising from this transaction, both the buyer and seller expressly submit to the jurisdiction of the courts of Valencia, waiving any other applicable jurisdiction or domain reservation.

COSTS AND EXPENSES: Legal fees, including lawyer and procurator fees, will always be borne by the party responsible for the breach of these general sales conditions or the contract in general.

SUPPLEMENTARY LAW: This sales contract will be governed by the terms herewith and, in the absence of specific provisions, by the Spanish Commercial Code for sales in Spain.

Conditions générales de vente

LE FAIT DE PASSER COMMANDE IMPLIQUE L'ACCEPTATION DES PRÉSENTES CONDITIONS GÉNÉRALES DE VENTE.

Toutes les ventes sont faites aux conditions énumérées ci-dessous. Toute spécification non conforme à ces conditions doit être préalablement acceptée par écrit par LYOPRO.

DEVIS. Les devis sont valables pour une durée maximale de 30 jours calendaires à compter de la date d'émission.

GARANTIE ET QUALITÉ. Tous les produits LYOPRO sont garantis contre les défauts de fabrication, mais ne couvrent pas les dommages dus à une mauvaise utilisation, une mauvaise manipulation ou une installation incorrecte. La garantie ne couvre pas non plus l'usure normale ou les dommages causés par du personnel non autorisé. Les différences mineures de taille, de couleur ou de qualité ne constituent pas un motif de réclamation. Toute réclamation doit être signalée dans les 48 heures suivant la réception du matériel. Pour bénéficier de la garantie, il est nécessaire de renvoyer le matériel pour analyse, de présenter la facture et de remplir le formulaire RMA. LYOPRO se réserve le droit de modifier ses produits sans préavis.

DÉLAI DE LIVRAISON : Les délais de livraison sont approximatifs et non garantis, et LYOPRO n'est pas responsable des dommages ou des indemnités en cas de retard. Le non-respect du délai de livraison ne permet pas au client d'annuler le contrat sans un délai supplémentaire pour résoudre le retard. Les cas de force majeure (guerres, grèves, catastrophes naturelles, pannes de machines, moules ou matrices, impossibilité d'acquérir des matières premières, interruptions de transport, fermetures de douanes ou toute autre mesure officielle pouvant affecter) peuvent entraîner un retard de livraison sans préavis. Chaque expédition est considérée comme une expédition indépendante, même si elle fait partie de la même commande.

PRIX / FRAIS DE PORT : Les prix seront ceux indiqués sur notre site web, sauf pour les accords explicites confirmés par LYOPRO. Conditions de livraison valables uniquement sur le territoire péninsulaire espagnol. Livraison gratuite à partir de 200€ pour les profils LED jusqu'à 2 mètres de long. Îles Canaries : Livraison gratuite à partir de 600€ pour les profils LED jusqu'à 2 mètres de long. En raison d'erreurs d'impression, d'évolution des produits ou de fluctuations des matières premières, LYOPRO se réserve le droit de modifier les prix sans préavis. Les profils de plus de 2 mètres entraîneront un supplément de 15 euros par expédition.

COMMANDES : Toutes les commandes de matériel coupé ou manipulé doivent être confirmées par écrit avant traitement. Pour les commandes supérieures à 1 500€, un paiement de 50 % à l'avance est requis. LYOPRO n'est pas responsable des commandes non confirmées par écrit. Les commandes payées par virement bancaire ne seront pas traitées avant réception du justificatif de paiement.

ANNULARIONS-RETOURS : Les retours ne sont pas acceptés après 15 jours suivant la livraison. Les commandes fermes ne peuvent être annulées sans l'accord de LYOPRO. Les retours pour des raisons non imputables à LYOPRO entraîneront des frais de réapprovisionnement de 20 % (minimum 10€). Les retours ne sont acceptés qu'avec l'autorisation de LYOPRO et un formulaire de retour dûment rempli. Les retours avec frais à la charge du client ne sont pas acceptés, sauf en cas d'erreur de LYOPRO. Les produits fabriqués sur mesure ou personnalisés ne peuvent pas être retournés.

RÉSERVATION DE PROPRIÉTÉ : Les biens fournis restent la propriété totale de LYOPRO jusqu'au paiement intégral. Le droit de propriété subsiste même si l'acheteur revend le produit, tant que la dette envers LYOPRO n'est pas réglée.

TRANSPORT : Toute anomalie du matériel ou incident de transport doit être enregistré sur le bon de livraison lors de la réception des marchandises. Le client doit signaler toute anomalie dans les 24 heures suivant la livraison. Il est de la responsabilité du client de gérer les réclamations auprès des transporteurs pour perte, dommage ou retard. En l'absence d'instructions spéciales d'expédition, LYOPRO choisira le mode de transport.

PAIEMENT : Les conditions de paiement seront celles convenues avec le client. Les paiements doivent être effectués ponctuellement selon tout document de paiement légalement accepté. En cas de retard, LYOPRO est en droit de facturer des intérêts de retard, ainsi que toute perte occasionnée par le retard de paiement. Les retards de paiement entraînent immédiatement l'annulation de tous les engagements de LYOPRO envers le client. L'acheteur n'est pas autorisé à retenir tout ou partie des paiements dus en raison de réclamations non reconnues, car cela ne l'exonère pas de ses obligations de paiement. Tout impayé ou retard dans le paiement annule la possibilité de crédit et suspend la fourniture de matériel tant que la situation n'est pas régularisée. En cas de répétition de cette situation, elle sera signalée à CRÉDITO & CAUCIÓN, et le crédit sera annulé de manière irrévocable.

COMPÉTENCE JURIDICTIONNELLE : Pour toute question ou litige découlant de la présente opération, l'acheteur et le vendeur se soumettent expressément à la compétence des tribunaux de Valence, renonçant à toute autre compétence ou réserve de juridiction qui pourrait leur être applicable.

FRAIS ET DÉPENSES : Les frais et coûts judiciaires, y compris les honoraires d'avocat et les droits de procureur, seront toujours à la charge de la partie contractante ayant causé ces frais en raison du non-respect de ces conditions générales de vente ou du contrat en général.

DROIT SUPPLÉMENTAIRE : Le présent contrat de vente sera régi par les termes convenus ici et, à défaut de dispositions spécifiques, par les normes du Code de commerce espagnol pour les ventes en Espagne.

Termini e condizioni di vendita

L'EFFETTUAZIONE DI UN ORDINE IMPLICA L'ACCETTAZIONE DELLE PRESENTI CONDIZIONI GENERALI DI VENDITA.

Tutte le vendite vengono effettuate alle condizioni elencate di seguito. Qualsiasi specifica non conforme alle presenti condizioni deve essere preventivamente accettata per iscritto da LYOPRO.

PREVENTIVI. Le offerte sono valide per un massimo di 30 giorni di calendario dalla data di emissione.

GARANZIA E QUALITÀ. Tutti i prodotti LYOPRO sono garantiti contro i difetti di fabbricazione, ma non coprono i danni dovuti a uso improprio, cattiva gestione o installazione non corretta. La garanzia non copre inoltre la normale usura o i danni causati da personale non autorizzato. Piccole differenze di dimensioni, colore o qualità non sono motivo di reclamo. Eventuali reclami devono essere segnalati entro 48 ore dal ricevimento del materiale. Per usufruire della garanzia, è necessario restituire il materiale per l'analisi, presentare la fattura e compilare il modulo RMA. LYOPRO si riserva il diritto di modificare i propri prodotti senza preavviso.

TERMINE DI CONSEGNA: I tempi di consegna sono indicativi e non garantiti, e LYOPRO non è responsabile per danni o risarcimenti derivanti da ritardi. Il mancato rispetto del termine di consegna non consente al cliente di annullare il contratto senza un ulteriore periodo di tempo per risolvere il ritardo. Cause di forza maggiore (guerre, scioperi, disastri naturali, guasti delle macchine, stampi o matrici, impossibilità di acquisire materie prime, interruzione dei trasporti, chiusura delle dogane o altre misure ufficiali che possano influire) possono causare ritardi nella consegna senza preavviso. Ogni spedizione è considerata indipendente, anche se fa parte dello stesso ordine.

PREZZI / SPESE DI SPEDIZIONE: I prezzi saranno quelli indicati nel nostro sito web, salvo espliciti accordi confermati da LYOPRO. Condizioni di spedizione valide solo nel territorio della Spagna peninsulare. Spese di spedizione gratuite a partire da 200€ per i profili LED fino a 2 metri di lunghezza. Isole Canarie: Spese di spedizione gratuite a partire da 600€ per i profili LED fino a 2 metri di lunghezza. A causa di errori di stampa, evoluzione dei prodotti o fluttuazioni delle materie prime, LYOPRO si riserva il diritto di modificare i prezzi senza preavviso. I profili superiori a 2 metri comporteranno un costo aggiuntivo di 15 euro per spedizione.

ORDINI: Tutti gli ordini di materiali tagliati o lavorati devono essere confermati per iscritto prima del trattamento. Per ordini superiori a 1.500€, è richiesto un pagamento anticipato del 50%. LYOPRO non è responsabile per ordini non confermati per iscritto. Gli ordini con pagamento tramite bonifico non saranno elaborati fino alla ricezione del comprovante di pagamento.

ANNULLAMENTI-RESTITUZIONI: Le restituzioni non sono accettate dopo 15 giorni dalla consegna. Gli ordini fissi non possono essere annullati senza l'approvazione di LYOPRO. Le restituzioni per motivi non imputabili a LYOPRO comportano una commissione del 20% (minimo 10€). Le restituzioni sono accettate solo con l'autorizzazione di LYOPRO e il modulo di restituzione compilato. Non sono accettate restituzioni con spese di spedizione a carico del cliente, salvo in caso di errore da parte di LYOPRO. I prodotti realizzati su misura o personalizzati non possono essere restituiti.

RISERVA DI PROPRIETÀ: La merce fornita rimane di proprietà esclusiva di LYOPRO fino al pagamento completo. Il diritto di proprietà persiste anche dopo che l'acquirente ha rivenduto il prodotto, fino a quando non sarà estinto il debito verso LYOPRO.

TRASPORTO: Eventuali anomalie del materiale o problemi di trasporto devono essere registrati sul bollettino di consegna al momento della ricezione delle merci. Il cliente deve informare dell'incidente entro 24 ore dalla consegna. È responsabilità del cliente gestire i reclami con i trasportatori per perdita, danno o ritardo. In assenza di istruzioni speciali di spedizione, LYOPRO sceglierà il trasporto.

PAGAMENTO: Le condizioni di pagamento saranno quelle concordate con il cliente. I pagamenti devono essere effettuati puntualmente secondo i documenti di pagamento legalmente accettati. In caso di ritardo, LYOPRO ha il diritto di addebitare interessi di mora, nonché eventuali perdite derivanti dal ritardo nel pagamento. I ritardi nei pagamenti comportano immediatamente l'annullamento di tutti gli impegni di LYOPRO nei confronti del cliente. Il compratore non è autorizzato a trattenere in tutto o in parte i pagamenti scaduti a causa di reclami non riconosciuti, in quanto ciò non lo esonera dal suo impegno di pagamento. Qualsiasi pagamento non effettuato o ritardato annulla la possibilità di credito e sospende la fornitura di materiali finché la situazione non viene regolarizzata. In caso di ripetizione di questa situazione, essa verrà comunicata a CRÉDITO & CAUCIÓN, e il credito sarà annullato in modo irrevocabile.

GIURISDIZIONE COMPETENTE: Per qualsiasi questione o controversia derivante da questa operazione, l'acquirente e il venditore si sottopongono espressamente alla competenza dei tribunali di Valencia, rinunciando a qualsiasi altra giurisdizione o riserva di giurisdizione che possa essere loro applicabile.

SPESE E COSTI: Le spese e i costi legali, inclusi gli onorari dell'avvocato e i diritti del procuratore, saranno sempre a carico della parte contraente che ha causato tali spese a causa della violazione delle presenti condizioni generali di vendita o del contratto in generale.

NORMA SUPPLENTE: Il presente contratto di vendita sarà regolato dalle disposizioni qui concordate e, in caso di mancanza di disposizioni specifiche, dalle norme del Codice di Commercio Spagnolo per le vendite in Spagna.

Oficinas

Calle 32, 130
Polígono Industrial EL BONY
46470 Catarroja (Valencia - Spain)
info@lightingproducts.es
Tel. +34 961 181 138
www.lyopro.es

Showroom

A-3, Avenida de las Tres Cruces, 63
46014 Patraix, (Valencia - Spain)
showroom@lightingproducts.es
Tel. +34 961 181 138

**TECHNICAL & ARCHITECTURAL
LIGHTING**

INNOVACIÓN Y PRECISIÓN SE UNEN.

EN LYOPRO, TRANSFORMAMOS ESPACIOS CON SOLUCIONES DE ILUMINACIÓN TÉCNICA QUE COMBINAN TECNOLOGÍA DE VANGUARDIA, EFICIENCIA ENERGÉTICA Y DISEÑO INTELIGENTE.

DESDE PROYECTOS ARQUITECTÓNICOS HASTA APLICACIONES INDUSTRIALES, NUESTRA LUZ NO SOLO ILUMINA: OPTIMIZA, INSPIRA Y REDEFINE ESTÁNDARES.

PORQUE LA EXCELENCIA NO ES SOLO BRILLO, ES INGENIERÍA EN SU MÁXIMA EXPRESIÓN. DESCUBRE CÓMO PODEMOS ILUMINAR EL FUTURO DE TUS PROYECTOS.