

LYOPRO

LED PROFILE

2024-2025
NEW PRODUCT CATALOGUE

Es un placer poder presentaros el nuevo catálogo LYOPRO LED PROFILE 2024, después de muchos meses de trabajo e investigación, damos a luz nuestro nuevo catálogo.

Tras analizar conjuntamente con nuestros clientes sus necesidades y realizar un estudio en profundidad de la demanda de mercado, hemos decidido incorporar más de 150 novedades entre tiras led, perfilera, fuentes de alimentación y controladores.

Un catálogo donde vas a poder encontrar más de 1000 referencias en stock que junto a nuestro departamento de proyectos y nuestra pasión por el trabajo y el servicio a nuestros clientes, estamos seguros de poder aportar todas las soluciones que necesitéis en cada uno de vuestros proyectos.

Gracias por iluminar nuestro camino.

We are delighted to present to you the new LYOPRO LED PROFILE 2024 catalogue which has been created over months of research and development.

After analysing the needs of our clients and carrying out an in depth study of the market, we have decided to introduce more than 150 new products ranging from led strips, to power supplies and controllers.

In this catalogue you will be able to find more than 1000 items and all the solutions that you need for your projects. And together with the help of our project team, and our passion for delivering a great service, we are sure that we can provide you with all the solutions for your individual needs.

Thank you for lighting our way.

Nous sommes ravis de vous présenter le nouveau catalogue LYOPRO LED PROFILE 2024 qui a été créé au fil de mois de recherche et développement.

Après avoir analysé les besoins de nos clients et réalisé une étude approfondie du marché, nous avons décidé d'introduire plus de 150 nouveaux produits allant des bandes LED aux alimentations et contrôleurs.

Un catalogue où vous pourrez trouver plus de 1000 références en stock qui, avec notre département de projet et notre passion pour le travail et le service à nos clients, nous sommes sûrs de pouvoir vous fournir toutes les solutions dont vous avez besoin dans chacun de vos projets.

Merci d'éclairer notre chemin.



Lighting with you

LYOPRO es una empresa joven y dinámica que da mucha importancia a la luz tanto en interiores como en exteriores. Realizamos proyectos de iluminación mediante un completo estudio lumínico tras conversación con el equipo de trabajo (distribución sobre plano, fotomontajes, cálculos lumínicos, ect), ajustándonos a las necesidades tanto económicas como estéticas, aportando ideas innovadoras y creativas para conseguir que la luz forme parte de la decoración.

Minucioso seguimiento a pie de obra, estableciendo reuniones con los profesionales para garantizar los resultados. LYOPRO, incorpora a sus proyectos nuevas tecnologías que en la actualidad van tomando relevancia en el mundo de la arquitectura y del interiorismo para marcar diferencias, como son, la DOMOTICA Y SISTEMAS SMART HOME, con nuestros controladores inalámbricos, junto a los conceptos de iluminación con LA TECNOLOGIA LED, RGB, RGBW, CCT, DMX y utilizando la mejor opción en regulación ya sea TRIAC, 0-10V, DALI, para encontrar la máxima eficiencia en cada obra con nuestros clientes. Para su desarrollo contamos con un departamento técnico además de un equipo comercial formado y a disposición del cliente para solventar cualquier consulta que surja en el día a día.

LYOPRO is a young and dynamic company that knows the equal importance of lighting, both indoors and outdoors. We carry out lighting projects by performing a complete lighting study. With a bespoke service with the project team (distribution on plan, photomontages, lighting calculations, ect), we can make adjustments to both your economic and aesthetics requirements to provide innovative and creative ideas to make lighting part of the enhancement of your space.

We include a complete follow-up on site, where we can organise professionals to work on your project to guarantee the results you desire. LYOPRO incorporates new technologies into its projects from the world of architecture and interior design for a seamless inclusion of products, such as DOMOTICS AND SMART HOME SYSTEMS, with wireless controllers, together with lighting concepts with LED TECHNOLOGY, RGB, RGBW, CCT, DMX and using the best dimming options, such as TRIAC, 0-10V, DALI, to provide first class solutions. To deliver this to you we have a technical department as well as a commercial team which is trained to solve any query that may arise on a day-to-day basis.



LYOPRO est une entreprise jeune et dynamique qui attache une grande importance à la lumière tant à l'intérieur qu'à l'extérieur. Nous réalisons des projets d'éclairage à travers une étude complète de la lumière après discussion avec l'équipe de travail (distribution sur plan, photomontages, calculs d'éclairage, ect), en nous adaptant aux besoins économiques et esthétiques, en fournissant des idées innovantes et créatives pour que la lumière fasse partie de la décoration.

Suivi minutieux sur place, mise en place de rencontres avec des professionnels pour garantir les résultats. LYOPRO, intègre à ses projets de nouvelles technologies qui gagnent actuellement en pertinence dans le monde de l'architecture et du design d'intérieur pour faire la différence, telles que la domotique et les systèmes de maison intelligente, avec nos contrôleurs sans fil, ainsi que des concepts d'éclairage avec la technologie LED, RGB, RGBW, CCT, DMX et en utilisant la meilleure option dans la réglementation soit TRIAC, 0-10V, DALI, pour trouver une efficacité maximale dans chaque travail avec nos clients. Pour son développement, nous disposons d'un département technique ainsi que d'une équipe commerciale formée et disponible pour résoudre toute question qui se pose au quotidien.

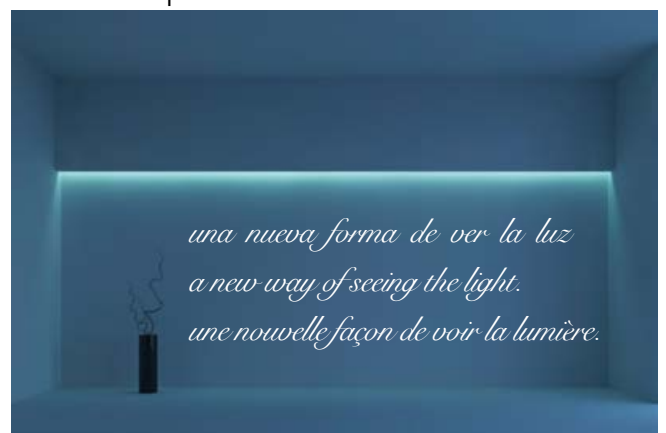

Lyopro Showroom es una nueva forma de enseñar nuestras luminarias al mundo. Un espacio creado para que nuestros clientes puedan ver en directo el impacto lumínico de las luminarias y su componente estético, diseño, material y calidad de todos y cada uno de los productos que conforman los distintos portfolios de nuestra marca. Un lugar construido a través de diferentes estancias para poder comprobar todo aquello que necesitas para seleccionar aquello que más le conviene a tu proyecto. Este proyecto de Showroom en Valencia nace de la necesidad de que nuestros clientes puedan conocer las luminarias que les recomendamos en cada uno de sus proyectos, es un espacio de creación en común con nuestros clientes. En nuestro Lyopro Showroom, podrás pasear por diferentes estancias en las que ver en funcionamiento nuestras luminarias más características de nuestros catálogos: LYOPRO LED PROFILE, LYOPRO LEVEL.

Disponemos de una red de Técnicos Comerciales expertos en el asesoramiento con nuestros clientes.

Lyopro Showroom is a new way of exhibiting and displaying our lighting solutions to the public. We created this space so that our clients can have a closer look at all the details of the lighting products from the different collections, such as their aesthetic, design, materials and quality. A place built through different stays to be able to check everything you need to select what you most suits your project. We conceptualised the Valencia showroom with the needs of our clients in mind because we wanted to be able to showcase our products. At the Lyopro Showroom, you can walk through different rooms where you can see our most well known products from our catalogues: LYOPRO LED PROFILE, LYOPRO LEVEL.

There is also always a commercial technician, who can assist you with their expertise.

Lyopro Showroom est une nouvelle façon de montrer nos luminaires au monde entier. Un espace créé pour que nos clients puissent voir en direct l'impact lumineux des luminaires et leur composante esthétique, leur design, leurs matériaux et la qualité de chacun des produits qui composent les différents portefeuilles de notre marque. Un endroit construit à travers différentes pièces pour vérifier tout ce dont vous avez besoin pour sélectionner ce qui convient à votre projet. Ce projet de showroom à Valence est né du besoin pour nos clients de connaître les luminaires que nous recommandons dans chacun de leurs projets, c'est un espace de création en commun avec nos clients. Dans notre Lyopro Showroom, vous pouvez vous promener dans différentes salles où vous pouvez voir en fonctionnement nos luminaires les plus caractéristiques de nos catalogues: LYOPRO LED PROFILE, LYOPRO LEVEL.

Nous disposons d'un réseau de techniciens commerciaux experts pour conseiller nos clients



CARACTERÍSTICAS TÉCNICAS TIRAS Y NEÓN / TECHNICAL CHARACTERISTICS STRIPS AND NEON / CARACTÉRISTIQUES TECHNIQUES BANDES ET NÉON Pag. 12-13

INDOOR SERIES ● 2200K - ● 2700K - ● 3000K - ○ 4000K - ● 6000K IP20 24V

Nombre / Name / Nom	Esquema / Scheme / Schème	Power	CRI	Led/M	Lumens/W	Led	Pag.
NEVADA	ANCHO 8mm. CORTE 125mm.	6W	>80	56	140	SMD	14
AUSTIN	ANCHO 5mm. CORTE 62.5mm.	7W	>80	512	100	COB	15
TAOS	ANCHO 8mm. CORTE 100mm.	9,6W	>80	60	95	SMD	16
MIAMI	ANCHO 8mm. CORTE 50mm.	9,6W	>80	140	140	SMD	17
BRISTOL	ANCHO 5mm. CORTE 50mm.	12W	>80	140	125	SMD	18
OREGÓN	ANCHO 8mm. CORTE 62.5mm.	12W	>80	112	140	SMD	19
CALIFORNIA	ANCHO 10mm. CORTE 50mm.	12W	>90	480	106	COB	20
MISURI	ANCHO 8mm. CORTE 100mm.	14,4W	>80	70	100	SMD	21
ORLANDO	ANCHO 8mm. CORTE 33,3mm.	14,4W	>80	210	140	SMD	22
ARIZONA	ANCHO 8mm. CORTE 41,7mm.	17W	>80	168	140	SMD	23
DENVER	ANCHO 10mm. CORTE 29,4mm.	19,2W	>80	238	140	SMD	24
DETROIT	ANCHO 10mm. CORTE 25mm.	24W	>80	240	120	SMD	25
KANSAS	ANCHO 10mm. CORTE 25mm.	48W	>80	240	110	SMD	26

INDOOR SERIES ●● RGB, ●●+○ RGB+W, ●●+●+○ RGB+CCT, ●+○ TUNABLE WHITE IP20 24V

Nombre / Name / Nom	Esquema / Scheme / Schème	Power	CRI	Led/M	Color	Led	Pag.
MADISON	ANCHO 10mm. CORTE 50mm.	12W	>90	840	●●●	COB	27
ALASKA	ANCHO 8mm. CORTE 100mm.	14,4W	>80	60	●●●	SMD	28
VIRGINIA	ANCHO 10mm. CORTE 100mm.	14,4W	>80	60	●●●	SMD	29
DAYTON	ANCHO 12mm. CORTE 33mm.	20W	>90	840	●●●+○	COB	30
TORONTO	ANCHO 14mm. CORTE 100mm.	26,4W	>90	180	●●●+●+○	SMD	31
GEORGIA	ANCHO 10mm. CORTE 50mm.	19,2W	>90	240	●+○	SMD	32

TIRA FLEXIBLE / FLEXIBLE STRIP / BLANDE FLEXI ● 3000K - ○ 4000K IP20 24V

Nombre / Name / Nom	Esquema / Scheme / Schème	Power	CRI	Led/M	Lumens/W	Led	Pag.
MICHIGAN	ANCHO 6mm. CORTE 100mm.	14,4W	>80	60	100	SMD	34

Índice tiras LED / Index LED strips / Index des bandes LED



WATERPROOF SERIES ● 2700K - ● 3000K - ○ 4000K - ● 6000K IP65/67 24V

Nombre / Name / Nom	Esquema / Scheme / Schème	Power	CRI	Led/M	Lumens/W	Led	IP	Pag.
NEVADA		6W	>80	56	140	SMD	67	36
TAOS		9,6W	>80	60	95	SMD	65	37
MIAMI		9,6W	>80	140	140	SMD	67	38
OREGÓN		12W	>80	112	140	SMD	67	39
CALIFORNIA		12W	>90	480	106	COB	67	40
MISURI		14,4W	>80	70	100	SMD	65	41
ORLANDO		14,4W	>80	210	140	SMD	67	42
ARIZONA		17W	>80	168	140	SMD	67	43
DENVER		19,2W	>80	238	140	SMD	67	44
DETROIT		24W	>80	240	120	SMD	67	45

WATERPROOF SERIES ●●● RGB ●●●+○ RGB+W ●●●+●+○ RGB+CCT ●+○ TUNABLE WHITE IP65/67 24V

Nombre / Name / Nom	Esquema / Scheme / Schème	Power	CRI	Led/M	Color	Led	IP	Pag.
MADISON		12W	>90	840	● ● ●	COB	67	46
ALASKA		14,4W	>80	60	● ● ●	SMD	65	47
VIRGINIA		14,4W	>80	60	● ● ●	SMD	67	48
DAYTON		20W	>90	840	● ● ● + ○	COB	67	49
TORONTO		26,4W	>90	180	● ● ● + ● + ○	SMD	67	50
GEORGIA		19,2W	>90	240	● + ○	SMD	67	51



FOOD SERIES IP65 24V

Nombre / Name / Nom	Esquema / Scheme / Schème	Tipo comida / Food type / Type de nourriture	Power	IP	Pag.
DAKOTA		Fruta / Fruit / Fruit	14,4W	67	53
		Pan / Bread / Pain	14,4W	67	53
		Queso / Chesse / Fromage	14,4W	67	53
		Pescado / Fish / Poisson	14,4W	67	53
		Frescos / Fresh / Frais	14,4W	67	53
		Carne / Meat / Viande	14,4W	67	53

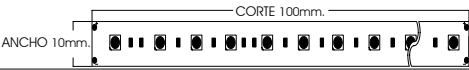

TIRAS 230V/STRIPS 230V/BANDES 230V ● 2200K - ● 2700K - ● 3000K - ○ 4000K - ● 6000K IP65

Nombre / Name / Nom	Esquema / Scheme / Schème	Power	CRI	Led/M	Lumens/W	Led	IP	Pag.
TUCSON		10W	>80	120	103	SMD	65	55
TEXAS		14W	>80	120	103	SMD	65	56

TIRAS 230V/STRIPS 230V/BANDES 230V ● 2200K - ● 2700K - ● 3000K - ○ 4000K - ● 6000K IP65

Nombre / Name / Nom	Esquema / Scheme / Schème	Power	CRI	Led/M	Lumens/W	Led	IP	Pag.
VEGAS		18W	>80	120	103	SMD	65	57
FRESNO 		10W	>80	600	110	COB	65	59

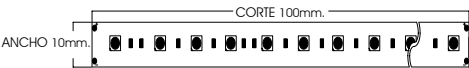
TIRAS 230V / STRIPS 230V / BANDES 230V ●●●●● COLORS, ●●● RGB IP65

Nombre / Name / Nom	Esquema / Scheme / Schème	Power	CRI	Led/M	Color	Led	IP	Pag.
TEXAS		14W	>80	120	●●●●●	SMD	65	56
MEMPHIS		14W	>80	60	●●●	SMD	65	58

NEÓN FLEX ● 2700K - ● 3000K - ○ 4000K - ● 6000K IP67 24V

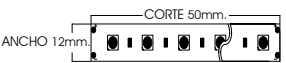
Nombre / Name / Nom	Esquema / Scheme / Schème	Power	CRI	Led/M	Color	Led	IP	Pag.
MONTANA		12W	>90	140	●●○●	SMD	67	61

NEÓN FLEX ●●●●● COLORS, ●●● RGB, ●●●+○ RGB+W IP67 24V

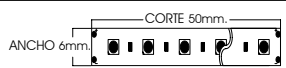
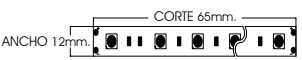
Nombre / Name / Nom	Esquema / Scheme / Schème	Power	CRI	Led/M	Color	Led	IP	Pag.
MONTANA		12W	>90	140	●●●●●	SMD	67	61
JACKSON		12W	>90	140	●●●●●+○	SMD	67	62



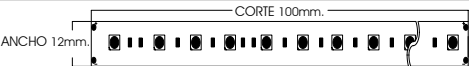

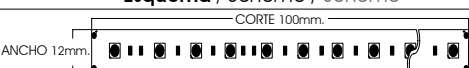
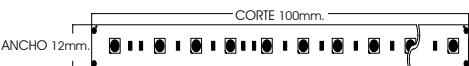

NEÓN FLEX ● 2700K - ● 3000K - ○ 4000K - ● 6000K IP67 230V

Nombre / Name / Nom	Esquema / Scheme / Schème	Power	CRI	Led/M	Color	Led	IP	Pag.
ASPEN		12W	>80	120	●●○●	SMD	65	64
PALMER		12W	>80	120	●●○●	SMD	65	65

NEÓN FLEX ●●●●● COLORS IP67 230V

Nombre / Name / Nom	Esquema / Scheme / Schème	Power	CRI	Led/M	Color	Led	IP	Pag.
ASPEN		12W	>80	120	●●●●●	SMD	65	64
PALMER		12W	>80	120	●●●●●	SMD	65	65

DIGITAL LIGHTING

Nombre / Name / Nom	Esquema / Scheme / Schème	Power	CRI	Led/M	Color	Led	IP	Pag.
EDISON		12W	>90	140		SMD	67	70
TROY		12W	>90	140		SMD	67	71
RENO		12W	>90	140		SMD	67	72
TUCAN		12W	>90	140		SMD	67	73
CISNE		12W	>90	140		SMD	67	74

LIGHTING CONTROL

Sistema de control / Control system / Système de contrôle

Pag.
70-74

WIFI CONTROL



MADRIX CONTROL



DMX CONTROL



NEÓN FLEX AMBIENTES EXIGENTES

HYDRA PISCINAS / SWIMMING POOLS / PISCINES



Pag.
76-79

HYDRA AGUAS TERMALES Y JACUZZIS / THERMAL WATERS AND JACUZZIS / EAUX THERMALES ET JACUZZIS



80-83

VOLCAN SAUNAS / SAUNAS / SAUNAS



84-87

DORUK AMBIENTES EXPLOSIVOS Y PELIGROSOS / EXPLOSIVE AND DANGEROUS ENVIRONMENTS / ENVIRONNEMENTS EXPLOSIFS ET DANGEREUX



88-91

TITAN ILUMINACION DE SUELO / FLOOR LIGHTING / ÉCLAIRAGE AU SOL



92-95

PERFILES DE SUPERFICIE / SURFACE PROFILES / Profils DE SURFACE

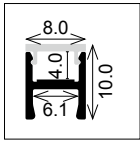

RIAD Pag. 98

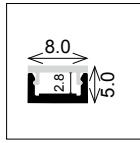

DOHA Pag. 99

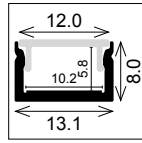

LEON Pag. 100

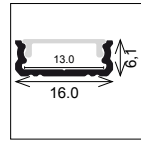

VILNA Pag. 101

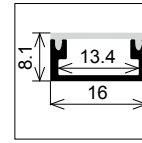

MUNICH Pag. 102

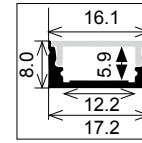

MONACO Pag. 103

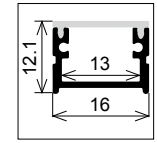

NAPOLIS Pag. 104

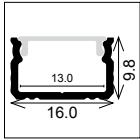

NAGOYA Pag. 105

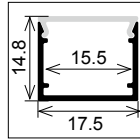

BAKU Pag. 106

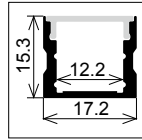

BUSAN Pag. 107

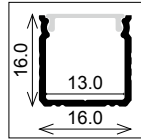

MUMBAI Pag. 108

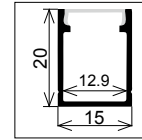

QUEBEC Pag. 109

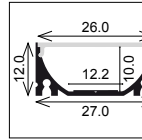

ARGEL Pag. 110

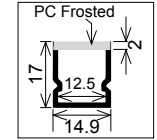

NILO Pag. 111

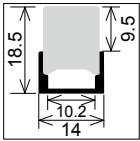

GANGES Pag. 112

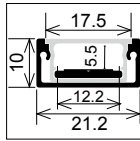

TURIA Pag. 113

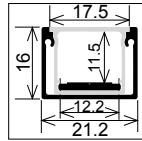

TAJO Pag. 114

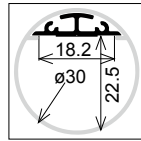

XINGU Pag. 115

PERFILES DE SUPERFICIE/SUSPENSIÓN / SURFACE/SUSPENSION PROFILES / Profils SURFACE/SUSPENSION

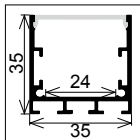

CANTÓN Pag. 117

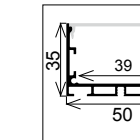

VICTORIA Pag. 118

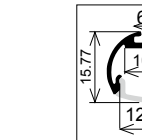

LYON Pag. 119

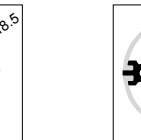

TURIN Pag. 120

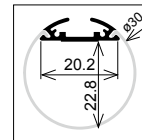

RIGA Pag. 121

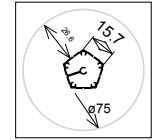

ESSEN Pag. 122

PERFILES ANGULARES / ANGLE PROFILES / Profils D'ANGLE

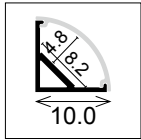

LAGOS Pag. 124

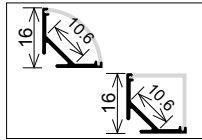

GLASGOW Pag. 125

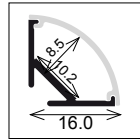

ROMA Pag. 126

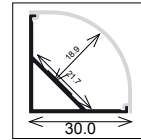

LEEDS Pag. 127

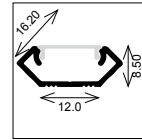

UTENA Pag. 128

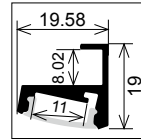

MONTREAL Pag. 129

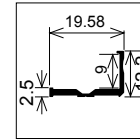

RECIFE Pag. 130

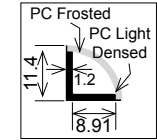

EBRO Pag. 131

PERFILES DE EMPOTRAR / RECESSED PROFILES / Profils ENCASTRÉS

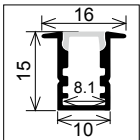

BURDEOS Pag. 133

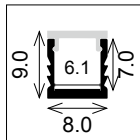

HANOI Pag. 134

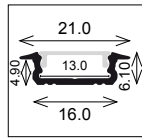

KAUNAS Pag. 135

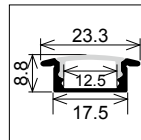

KUWAIT Pag. 136

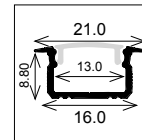

YEDA Pag. 137

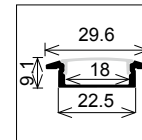

TALLIN Pag. 138

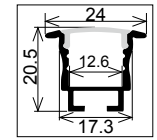

DAKAR Pag. 139

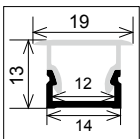

BASEL Pag. 140

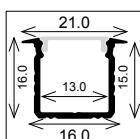

BASILEA Pag. 141

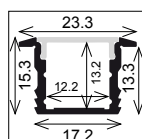

MONTERREY Pag. 142

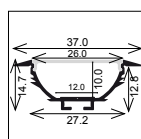

HARBIN Pag. 143

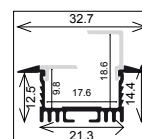

ZURICH Pag. 144

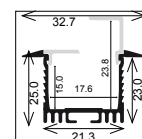

ULSAN Pag. 145

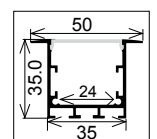

LINZ Pag. 146

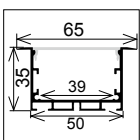

PERTH Pag. 147

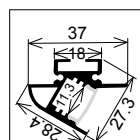

DELHI Pag. 148

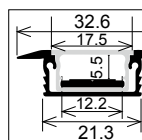

VOLGA Pag. 149

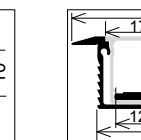

BRAVO Pag. 150

PERFILES ARQUITECTÓNICOS / ARCHITECTURAL PROFILES / Profilés ARCHITECTURAUX

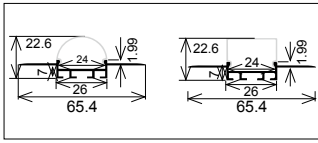

ANKARA Pag. 152

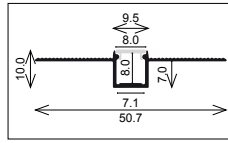

LIEJA Pag. 153

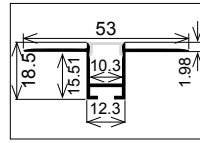

VALENCIA Pag. 154

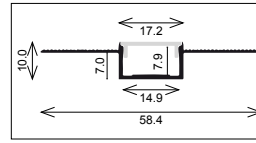

LUGO Pag. 155

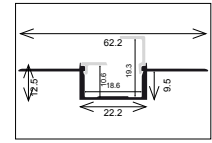

HEFEI Pag. 156

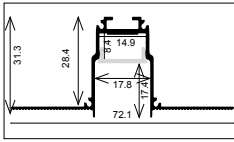

SURAT Pag. 157

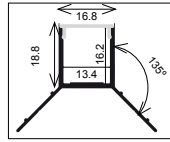

CALCUTA Pag. 158

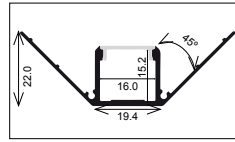

BERNA Pag. 159

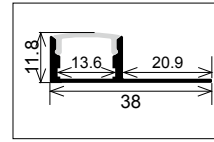

BURSA Pag. 160

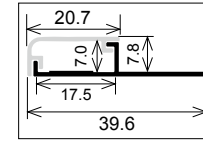

BARI Pag. 161

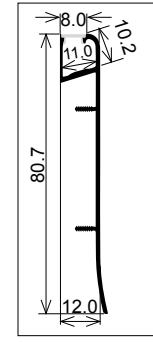

BOON Pag. 163

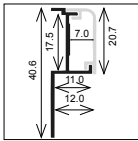

CALGARY Pag. 162

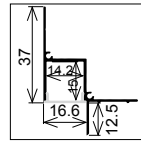

VARNA Pag. 164

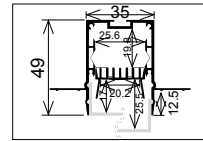

MURCIA Pag. 165

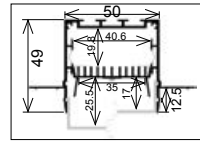

COLONIA Pag. 166

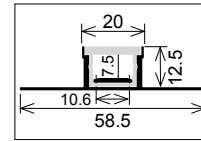

SENA Pag. 167

PERFILES DE SUELO / SOIL PROFILES / Profilés DE SOL

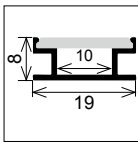

BREMEN Pag. 169

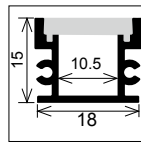

MACAU Pag. 170

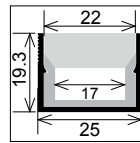

TIGRIS Pag. 171

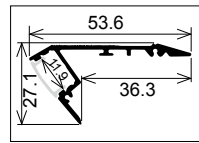

SEVILLA Pag. 172

PERFILES FLEXIBLES / FLEXIBLE PROFILES / Profilés FLEXIBLES

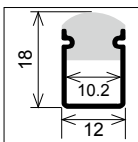

OSLO Pag. 174

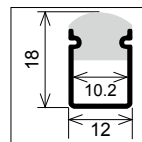

NANTES Pag. 175

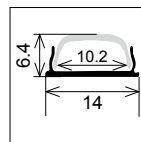

NIZA Pag. 176

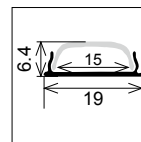

HAIFA Pag. 177

PERFIL IMANTADO MAGNETIC PROFILE PROFIL MAGNÉTIQUE

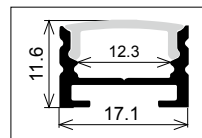

BANGKOK Pag. 179

PERFIL PERCHERO PROFILE HANGER CINTRE DE PROFIL

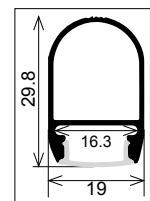

ATLANTA Pag. 181

LUMINARIAS CIRCULARES / PROFILE HANGER / CINTRE DE PROFIL

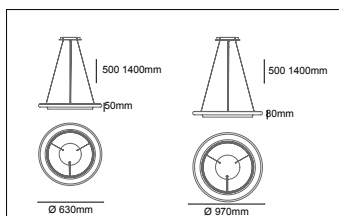

JULY Pag. 183

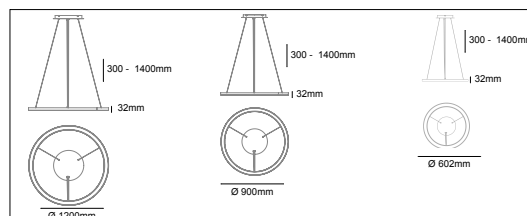

MERY Pag. 184

DRIVERS PARA TIRAS LED / DRIVERS FOR LED STRIPS / DRIVERS POUR BANDES LED

DRIVERS LYOPRO IP20 / LYOPRO IP20 DRIVERS / DRIVERS LYOPRO IP20	Pag. 186
DRIVERS LYOPRO IP67 / LYOPRO IP67 DRIVERS / DRIVERS LYOPRO IP67	Pag. 186

SISTEMAS DE CONTROL / CONTROL SYSTEMS / SYSTÈMES DE CONTRÔLE

CONTROLADORES 24V / 24V CONTROLLERS / CONTRÔLEURS 24V	Pag. 189/192
CONTROLADORES 230V / CONTROLLERS 230V / CONTRÔLEURS 230V	Pag. 193/195
CONTROLADOR TUYA / TUYA CONTROLLER / CONTRÔLEUR TUYA	Pag. 196/197
CONTROLADOR DALI / DALI CONTROLLER / CONTRÔLEUR DALI	Pag. 198
CONTROLADOR 1-10V / CONTROLLER 1-10V / CONTRÔLEUR 1-10V	Pag. 199/200
CONTROLADOR PARA ESCALERAS / CONTROLLER FOR STAIRS / CONTRÔLEUR POUR ESCALIERS	Pag. 201
SMART DRIVER / SMART DRIVER / SMART DRIVER	Pag. 202/203
SENSORES 24V / 24V SENSORS / DÉTECTEUR 24V	Pag. 204
MANDOS / CONTROLS / CONTRÔLES	Pag. 205/208
PULSADORES / PUSHBUTTONS / BOUTONS POUSSOIR	Pag. 209
CENTRAL WIFI / WIFI CENTER / CENTRE Wi-Fi	Pag. 209

GUIA COMPOSICIÓN TIRAS, CONTROLADORES Y MANDOS

STRIP COMPOSITION GUIDE, CONTROLLERS AND CONTROLS

GUIDE DE COMPOSITION DES BANDES, CONTRÔLEURS ET CONTRÔLES

Pag. 210/211

EXPOSITORES / EXHIBITORS / EXPOSANTS

Pag. 212

OPCIONES DE CORTE / CUTTING OPTIONS / OPTIONS DE COUPE

Pag. 213

CONDICIONES DE VENTA / TERMS OF SALE / CONDITIONS DE VENTE

Pag. 214.216

CONSISTENCIA DE COLOR / COLOR CONSISTENCY / COHERENCE DES COULEURS

Todas las tiras LYOPRO trabajan con 3.Step Mac-Adam, y con ello aseguramos el mismo color de temperatura en diferentes producciones. All LYOPRO strips work with 3.Step Mac-Adam, and with this we ensure the same color temperature in different productions. Toutes les bandes LYOPRO fonctionnent avec 3.Step Mac-Adam, et avec cela, nous assurons la même température de couleur dans différentes productions.

BIN-Color Consistencia del color- Definición de BIN de color LED (CIE 1931 UCS)
 BIN-Color color consistency- LED Color BIN definition (CIE 1931 UCS)
 Cohérence des couleurs BIN-Color. Définition de BIN de couleur de LED (CIE 1931 UCS)

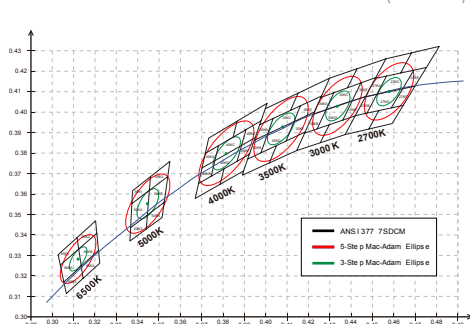

5-Step Mac-Adam Ellipse			
CCT	CCT tra ng±D	uv Range	
2700K	2725 K ± 100	0.0000 ± 0.0006	
3000K	3045 K ± 120	0.0000 ± 0.0008	
3500K	3465 K ± 175	0.0000 ± 0.0006	
4000K	3985 K ± 200	0.0000 ± 0.0006	
5000K	5028 K ± 200	0.0000 ± 0.0006	
6500K	6530 K ± 350	0.0020 ± 0.0006	

3-Step Mac-Adam Ellipse			
CCT	CCT tra ng±D	uv Range	
2700K	2725K ± 60	0.0000 ± 0.0006	
3000K	3045K ± 70	0.0000 ± 0.0006	
3500K	3465K ± 100	0.0000 ± 0.0006	
4000K	3985K ± 120	0.0000 ± 0.0006	
5000K	5028K ± 120	0.0000 ± 0.0006	
6500K	6530K ± 200	0.0000 ± 0.0006	

2-Step Mac-Adam Ellipse			
CCT	CCT tra ng±D	uv Range	
2700K	2725K ± 40	0.0000 ± 0.0006	
3000K	3045K ± 50	0.0000 ± 0.0006	
3500K	3465K ± 70	0.0000 ± 0.0006	
4000K	3985K ± 80	0.0000 ± 0.0006	
5000K	5028K ± 80	0.0000 ± 0.0006	
6500K	6530K ± 150	0.0000 ± 0.0006	

ESTRUCTURA TIRAS LED / LED STRIP STRUCTURE / BANDES LED STRUCTURÉES

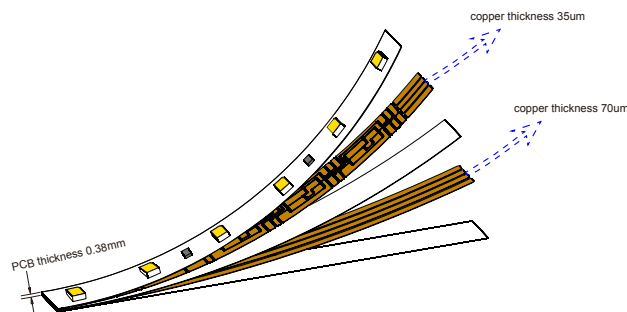

Nuestras tiras tienen un alto rendimiento, por eso trabajamos con doble capa de cobre de 3 onzas para alargar al máximo las horas de vida. Our strips have a high performance, that is why we work with a double layer of 3-ounce copper to maximize the hours of life. Nos bandes ont une haute performance, c'est pourquoi nous travaillons avec une double couche de cuivre de 3 onces pour maximiser les heures de vie.

TEMPERATURA DE COLOR CCT / CCT COLOR TEMPERATURE / TEMPÉRATURE DE COULEUR CCT

Temperatura de color, comúnmente abreviada como CCT. La temperatura de color describe el color emitido por una fuente de luz, y tiene una influencia directa y más inmediata en la aparición de un objeto. CCT es un número, medido en grados Kelvin, que ayuda a describir la calidez o frialdad relativas de una fuente de luz. Rango de luz LED de 2700 K (color blanco cálido, como el anochecer y mañana) a 5000 K o superior (color de luz diurna blanca, como la tarde tiempo) Simulación de la luz solar con referencia al color de la luz solar de 12 horas durante el día, nos ayuda a producir tiras de LED que son infinitamente cerca de la luz del sol para que la gente se sienta cómoda. Como se muestra en la imagen de la derecha.

Color temperature, commonly abbreviated as CCT. Color temperature describes the color emitted by a light source, and has a direct and more immediate influence on the appearance of an object. CCT is a number, measured in degrees Kelvin, that helps to describe the relative warmth or coolness of a light source. 2700K LED light range (warm white, like dusk and morning) at 5000K or higher (daylight color white, such as afternoon time) Simulation of sunlight with reference to the color of 12-hour sunlight during the day, it helps us produce LED strips that are infinitely close to the sunlight so that people feel comfortable. As shown in the image on the right.

Température de couleur, communément abrégée en CCT. La température de couleur décrit la couleur émise par une source lumineuse, et a une influence directe et plus immédiate sur l'apparition d'un objet. CCT est un nombre, mesuré en degrés Kelvin, qui aide à décrire la chaleur ou la fraîcheur relative d'une source lumineuse. Gamme de lumière LED 2700K (blanc chaud, comme le crépuscule et matin) à 5000K ou plus (couleur de la lumière du jour blanche, comme l'après-midi temps) Simulation de la lumière du soleil en référence à la couleur de la lumière du soleil sur 12 heures pendant la journée, cela nous aide à produire des bandes de LED qui sont infiniment près de la lumière du soleil pour que les gens se sentent à l'aise. Comme le montre le image à droite.

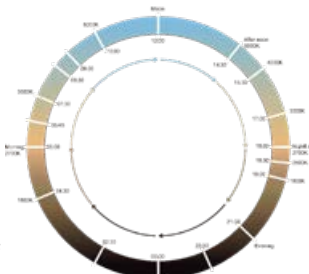

Solicitud de TMC / CCT Application / Demande de TMC

Cuando usamos una fuente de luz artificial como una luz LED, estamos intentando "reproducir" los colores de luz natural para ayudar a que los objetos tengan el mismo aspecto que cuando están bajo la luz natural del día. Para la mayoría de las aplicaciones residenciales, 2700K y 3000K son las opciones de temperatura de color preferidas, ya que ambas crear un ambiente acogedor y relajante. Para aplicaciones minoristas o comerciales, 4000K es una opción de color popular para un tono de blanco más nítido y energético. Para aplicaciones industriales u orientadas a tareas, 5000K o 6500K son las opciones de color preferidas ya que estos colores las temperaturas se adaptan mejor a lo natural del día.

When we use an artificial light source such as an LED light, we are attempting to "reproduce" the colors of natural daylight in order to help the objects appear the same as they do when they are under natural day light. For most residential applications, 2700K and 3000K are preferred color temperature options as they both create an inviting and relaxing environment. For retail or commercial applications, 4000K is a popular color option for a crisper, energetic shade of white. For industrial or task-oriented application, 5000K or 6500K are preferred color options as these color temperatures best match natural daylight.

Lorsque nous utilisons une source de lumière artificielle comme une lumière LED, nous essayons de "reproduire" les couleurs de lumière naturelle pour aider les objets à avoir le même aspect que lorsqu'ils sont à la lumière du jour. Pour la plupart des applications résidentielles, 2700K et 3000K sont les options de température de couleur préférées, car les deux créent un environnement confortable et relaxant. Pour les applications de vente au détail ou commerciales, 4000K est un choix de couleur populaire pour une nuance de blanc nette et plus énergique. Pour les applications industrielles ou axées sur les a, 5000K ou 6500K sont les choix de couleurs préférés car ces couleurs les températures sont mieux adaptées à la nature naturelle de la journée.



ÍNDICE DE REPRODUCCION CROMATICA CRI / COLOR RENDERING INDEX CRI / INDICE DE RENDU DES COULEURS IRC

En pocas palabras, el índice de reproducción cromática (CRI) mide la capacidad de una fuente de luz para reproducir con precisión los colores del objeto que ilumina. Si no tiene una fuente de luz CRI alta, los objetos pueden aparecer descoloridos, opacos o inexactos. Los valores de CRI superiores a 90 se consideran excelentes, mientras que las puntuaciones inferiores a 80 se consideran deficientes (la figura siguiente).

Put simply, the Color Rendering Index (CRI) measures the ability of a light source to accurately reproduce the colors of the object it illuminates. If without a high CRI light source, objects can appear faded, dull or inaccurate. CRI values over 90 are considered as excellent, while scores below 80 are considered as poor. (the below fig.)

En termes simples, l'indice de rendu des couleurs (IRC) mesure la capacité d'une source lumineuse à reproduire avec précision les couleurs de l'objet qu'il éclaire. Si vous ne disposez pas d'une source lumineuse à IRC élevé, les objets peuvent apparaître délavés, ternes ou inexacts. Les valeurs d'IRC supérieures à 90 sont considérées comme excellentes, tandis que les notes inférieures à 80 sont considérées comme médiocres (figure ci-dessous).

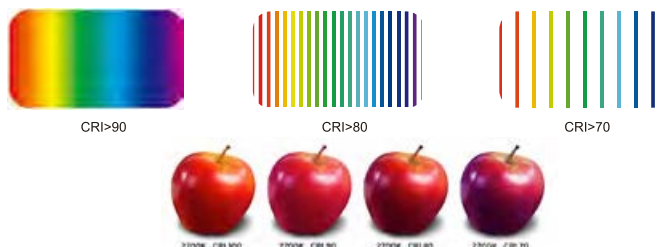

CRI EXTENDIDO / EXTENDED CRI / CRI ÉTENDU

El CRI extendido se calcula como el valor promedio de R1 a R15. En particular, el CRI extendido captura el influencia de colores saturados como ROJO profundo (R9) y AZUL fuerte (R12). El CRI se puede dividir aún más en subpuntuaciones conocidas como valores "R", que también tienen un máximo de 100. Cada valor "R" representa la capacidad de reproducción cromática de la fuente de luz para un color u objeto en particular.

Extended CRI is calculated as the average value of R1 through R15. Notably, extended CRI captures the influence of saturated colors such as deep RED(R9) and strong BLUE (R12). CRI can be further broken down into sub-scores known as "R" values, which also have a maximum of 100. Each "R" value represents the light source's color rendering ability for particular color or object.

L'IRC étendu est calculé comme la valeur moyenne de R1 à R15. En particulier, l'IRC étendu capture l'influence des couleurs saturées comme le ROUGE profond (R9) et le BLEU fort (R12). L'IRC peut être divisé en sous-scores appelés valeurs "R", qui ont également un maximum de 100. Chaque valeur "R" représente la capacité de rendu des couleurs de la source lumineuse pour une couleur ou un objet particulier.

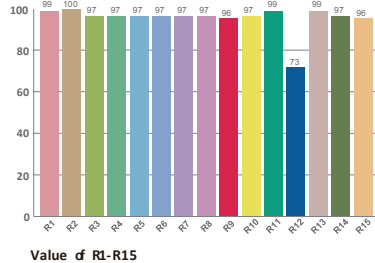

Una puntuación de R9 de 50 o superior se considerará "buena", mientras que la puntuación R9 de 90 superior se considera "excelente".
R9 score of 50 or above would be considered as "good", while R9 score of 90 above considered "excellent."

Un score R9 de 50 ou plus sera considéré comme "bon", tandis que un score R9 de 90 ou plus est considéré comme "excellent".

¿Por qué Deep RED (R9) es un color importante? / Why is Deep RED(R9) an important color? / Pourquoi Deep RED (R9) est-il une couleur importante ?

Si una fuente de luz artificial carece de emisión roja, funcionará mal en la escala R9, y también hacer que los objetos se vean pálidos, o incluso verdes. Cuando busque un LED de alta calidad de color, asegúrese de consultar el valor CRI y el valor R9.

If an artificial light source lacks red emission, it will perform poorly on the R9 scale, and also make the objects look pale, or even green. When searching for a high color quality LED, be sure to inquire about CRI value as well as its R9 value.

Si une source de lumière artificielle manque d'émission rouge, elle fonctionnera mal sur l'échelle R9, et aussi rendre les objets pâles, voire verts. Lorsque vous recherchez une LED de haute qualité de couleur, assurez-vous de regarder la valeur CRI et la valeur R9.

GRADOS IP / IP GRADES / CLASSES IP

Grado de protección contra la penetración de cuerpos sólidos (1º dígito) y contra líquidos (2º dígito).
 Degree of protection against the penetration of solid bodies (1st digit) and against liquids (2nd digit).
 Degré de protection contre la pénétration de corps solides (1er chiffre) et contre les liquides (2ème chiffre).

Como se codifica / How it is encoded / comment coder Primer número / First number / premier numéro Segundo número / Second number / deuxième numéro



Grado de protección / Degree of protection / Degré de protection
 Grado de protección contra objetos y polvo (0-4) / Degree of protection against objects and dust (0-4) / Degré de protection contre objets et poussière (0-4)
 Grado de protección contra líquidos (0-8) / Degree of protection against liquids (0-8) / Degré de protection contre liquides (0-8)

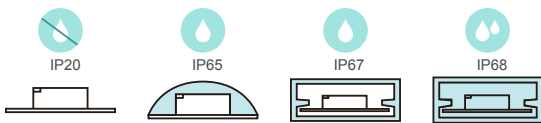

Primer número / First number / Premier numéro

Not protected	Protected against solid bodies of more than 50mm	Protected against solid bodies of more than 12mm	Protected against solid bodies of more than 2.5mm
Protected against solid bodies of more than 1mm	Protected against the penetration of dust	Completely dust-tight	

Segundo número / Second number / Deuxième numéro

Not protected	Protected against the vertical drop of water droplets	Protected against vertical drops of water droplets with a maximum inclination of 15°	Protected against fine rain (sprayed)	Protected against water projections
Protected against water jets	Protected against strong jets of water or against the rough sea	Protected against the effects of temporary immersion	Protected against prolonged immersion	

TEST DE CALIDAD / QUALITY TEST / ESSAI DE QUALITÉ

Todas las tiras LYOPRO pasan los mas exigentes test de calidad.
 All LYOPRO strips pass the most demanding quality tests.

Toutes les bandes LYOPRO passent les tests de qualité les plus exigeants.

PRUEBA FOTOMÉTRICA / PHOTOMETRIC TEST / TEST PHOTOMÉTRIQUE

Análisis de espectro / Spectrum analysis / Analyse de spectre
 Distribución fotométrica / Photometric distribution / Distribution photométrique
 Mantenimiento de lúmenes y tiempo de vida / Lumen Maintenance and / Maintenance et durée de vie du flux lumineux

PRUEBA ELÉCTRICA / ELECTRICAL TEST / TEST ELECTRIQUE

Prueba ESD / ESD test / Analyse de spectre
 Prueba EMC (EMI y EMS) / EMC Test (EMI & EMS) / Test CEM (EMI et EMS)

PRUEBAS MECÁNICAS Y FÍSICAS / MECHANICS & PHYSICS TESTING / ESSAIS MECANIKES ET PHYSIQUES

Prueba de flexión vertical / Bending Test Vertical / Essai de flexion verticale
 Prueba de flexión horizontal / Bending Test Horizontal / Essai de flexion horizontale
 Prueba de oscilación / Swing Test / Essai de balancement
 Ensayo de tracción / Tensile Test / Essai de traction
 Prueba de torsión / Twist Test / Essai de torsion
 Prueba de adhesión / Adhesion Test / Test d'adhérer

PRUEBAS AMBIENTALES / ENVIRONMENT TESTING / ESSAIS ENVIRONNEMENTAUX

Prueba de calentamiento / Salt Spray Test / Test de pulvérisación de sal
 Prueba del spray de sal / Bending Test Horizontal / Essai de flexion horizontale
 Impacto de alta temperatura y humedad / High temperature and Humidity Impact / Impact des températures élevées et de humidité
 Prueba de choque de temperatura / Temperature Shock Test / Test de choc thermique
 Prueba de exposición UV / UV Exposure Test / Test d'exposition aux UV
 Prueba IPX5 IPX6 IPX7 IPX8 / IPX5 IPX6 IPX7 IPX8 Test / Test IPX5 IPX6 IPX7 IPX8



FUENTE DE LUZ / LIGHT SOURCE / SOURCE DE LUMIÈRE

Parámetros de color / Color parameters / Paramètres de couleur

Coordenada de cromaticidad, índice de reproducción cromática
 Chromaticity coordinate, color rendering index
 Coordonnée de chromaticité, indice de rendu des couleurs

Parámetros de la foto / Photo parameters / Paramètres des photos

Parámetros eléctricos / Electrical parameters / Paramètres des photos

* Para obtener informes detallados de las pruebas, comuníquese con nuestro representante de ventas.
 * For detail testing reports, please contact our sales person.
 * Pour des rapports de test détaillés, veuillez contacter notre vendeur.

PRUEBAS DE TENSIÓN / TENSILE TESTING / ESSAI DE TRACTION

se prueba según GB/16491
 It is tested according to GB/16491
 Il est testé selon GB/16491

Cantidad de Muestra / Sample Quantity / Quantité d'échantillon

SIDC 1m
 SIDC 1m
 SIDC 1m

Criterios de calificación / Qualification Criteria / Critères de qualification

Para determinar de acuerdo con el requisitos técnicos correspondientes
 To determine according to the corresponding technical requirements
 A déterminer selon les exigences techniques correspondantes





LYOPRO

LED PROFILE

Tecnología LED lineal flexible, para iluminación de uso interior a nivel profesional, donde se presentan distintas opciones en potencias, temperaturas de color, reproducción cromática y siempre con altas prestaciones en eficiencia energética.

Flexible linear LED technology, for interior lighting at a professional level, where different options are presented in powers, color temperatures, color rendering and always with high performance in energy efficiency.

Technologie LED linéaire flexible, pour l'éclairage intérieur à un niveau professionnel, où différentes options sont présentées dans les puissances, les températures de couleur, le rendu des couleurs et toujours avec des performances élevées en matière d'efficacité énergétique.

Indoor Series

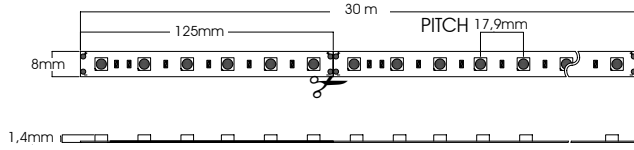

Aplicaciones: / Applications: / Applications:

Recomendada para instalaciones en uso interior. Ideal para comercios, iluminación técnica y decorativa.

Recommended for indoor installations. Ideal for shops, technical and decorative lighting.

Recommandé pour les installations intérieures. Idéal pour les magasins, l'éclairage technique et décoratif.

Importante instalar disipador de calor / Important to install heat sink / Important d'installer le dissipateur de chaleur.

Referencia Reference Référence	CCT(K)	Lumens/M	Lumens/W	PVP/M
86025	2700k	780 lm/m	130 lm/W	8.95€
80026	3000k	800 lm/m	133 lm/W	
80027	4000k	820 lm/m	136 lm/W	
80028	6000k	840 lm/m	140 lm/W	

TEST LM 80

LM 79

LDT

Disipador Heat sink Dissipateur

LED SMD 2835

Clase III

Non Flicker

3 Years Warranty

24V

6 w/m

120°

TÜV Rheinland ZERTIFIZIERT

GS

Dimmable

-20°C -50°C

IP20

125mm

CE

ETL

UL

RoHS

Recycling symbol

Características técnicas / Technical data / Caractéristiques techniques

Potencia rollo / Roll Power / Puissance de Roulis	180 W
CRI CRI	>80
Leds/m Leds/m	56 LED/M
Pitch Pitch	17,9 MM
SDCM SDCM	≤3
Corte min. / Min. Cutting Length / Min. coupure	125 MM
Longitud rollo / Roll Length / Longueur du Rouleau	30 M
Vida útil / Life time / Durée de vie	75.000 H
Temperatura trabajo / Working temperature / Température de Fonctionnement	-20+50°C
Marca punto Tc / Tc Point mark / Marque de point Tc	Si / Yes / Oui
PCB PCB	3 oz
Longitud máx. / Max length. / Longueur max.	10 M

Perfiles / Profiles / Profilés

Perfil compatible con tira. / Strip compatible profile. / Profilé compatible bande. Perfil no compatible con tira. / Profile not compatible with strip. / Profilé non compatible avec la bande.

AUSTIN 7w/m COB · IP20 · 24v · Cri>80

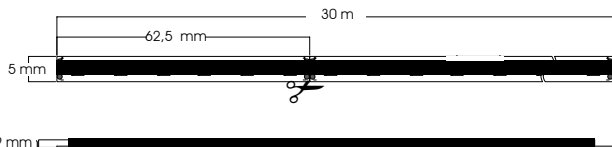

Aplicaciones: / Applications: / Applications:

Recomendada para instalaciones en uso interior. Ideal para comercios, iluminación técnica y decorativa.
Recommended for indoor installations. Ideal for shops, technical and decorative lighting.

Recommandé pour les installations intérieures. Idéal pour les magasins, l'éclairage technique et décoratif.

Importante instalar disipador de calor / Important to install heat sink / Important d'installer le dissipateur de chaleur.

Referencia Reference Référence	CCT(K)	Lumens/M	Lumens/W	PVP/M
86070	2700k	658 lm/m	94 lm/W	12,95€
86071	3000k	665 lm/m	95 lm/W	
86072	4000k	679 lm/m	97 lm/W	
86073	6000k	700 lm/m	100 lm/W	



Características técnicas / Technical data / Caractéristiques techniques

Potencia rollo / Roll Power / Puissance de Roulis	210 W
CRI CRI	>80
Leds/m Leds/m	512 LED/M
Pitch Pitch	Led continuo / Continuous led / Led continue
SDCM SDCM	≤3
Corte min. / Min. Cutting Length / Min. coupure	62,5 MM
Longitud rollo / Roll Length / Longueur du Rouleau	30 M
Vida útil / Life time / Durée de vie	75.000 H
Temperatura trabajo / Working temperature / Température de Fonctionnement	-20+50°C
Marca punto Tc / Tc Point mark / Marque de point Tc	Si / Yes / Oui
PCB PCB	3 oz
Longitud máx. / Max length. / Longueur max.	10 M

Perfiles / Profiles / Profilés

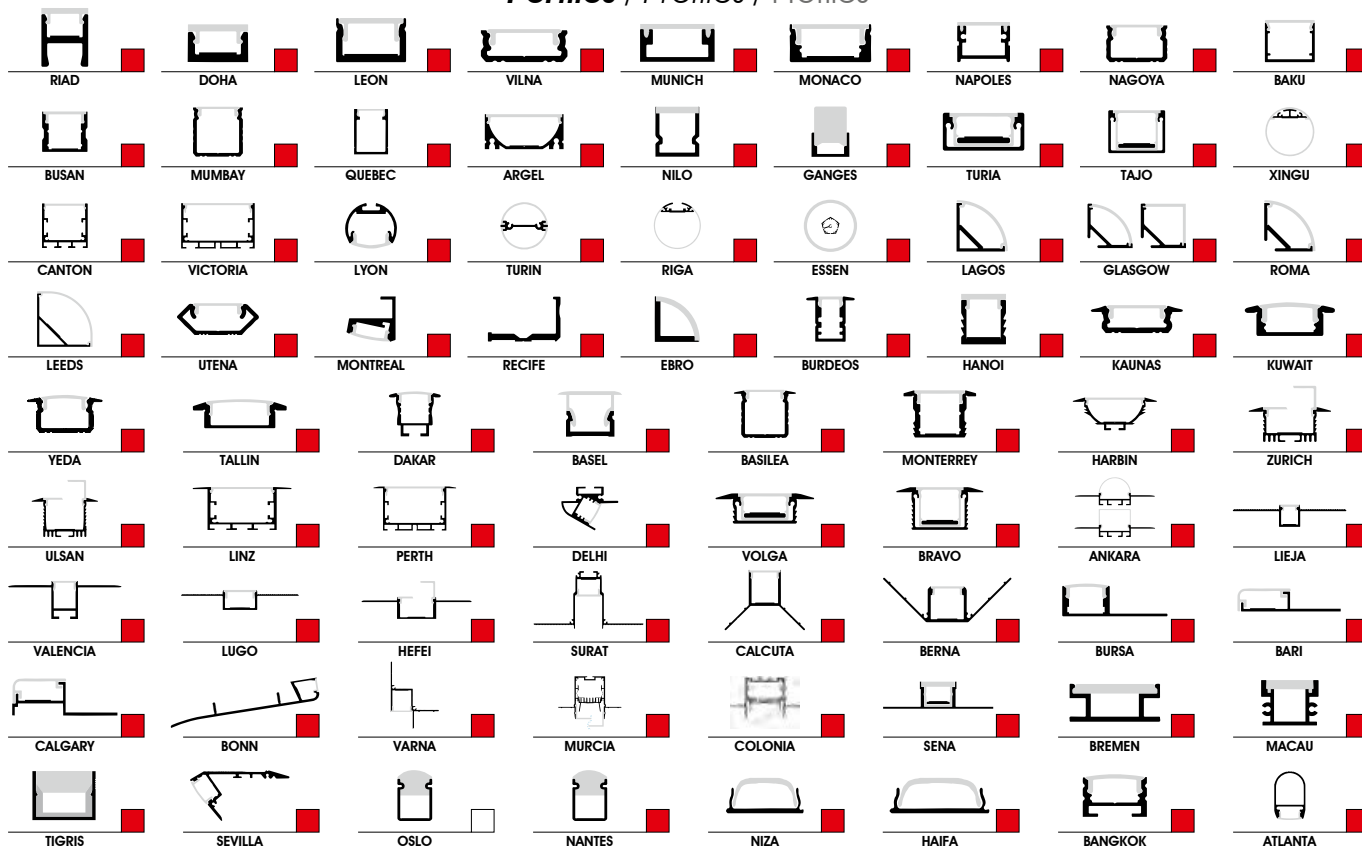

■ Perfil compatible con tira. / Strip compatible profile. / Profilé compatible bande. □ Perfil no compatible con tira. / Profile not compatible with strip. / Profilé non compatible avec la bande.

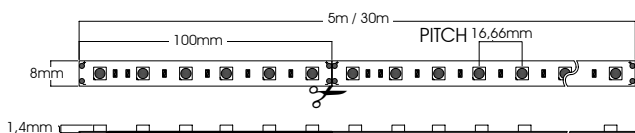

Aplicaciones / Applications / Applications:

Recomendada para instalaciones en uso interior. Ideal para comercios, iluminación técnica

Recommended for indoor installations. Ideal for shops, technical and decorative lighting.

Recommandé pour les installations intérieures. Idéal pour les magasins, l'éclairage technique et décoratif.

Importante instalar disipador de calor / Important to install heat sink / Important d'installer le dissipateur de chaleur.

Referencia Reference Référence	CCT(K)	Lumens/M	Lumens/W	PVP/M
84350	2700k	864 lm/m	90 lm/W	5,75€ / M
84351	3000k	874 lm/m	91 lm/W	
84352	4000k	892 lm/m	93 lm/W	
84353	6000k	912 lm/m	95 lm/W	
84355	2700k	864 lm/m	90 lm/W	
84356	3000k	874 lm/m	91 lm/W	26,95€ / 5M
84357	4000k	892 lm/m	93 lm/W	
84358	6000k	912 lm/m	95 lm/W	

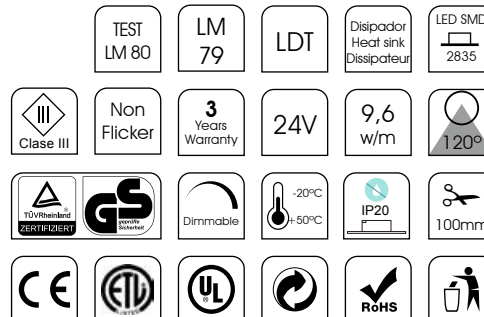

Características técnicas / Technical data / Caractéristiques techniques

Potencia rollo / Roll Power / Puissance de Roulis	48 W / 288 W
CRI / CRI	>80
Leds/m Leds/m	60 LED/M
Pitch / Pitch	16,66 MM
SDCM / SDCM	≤3
Corte min. / Min. Cutting Length / Min. coupure	100 MM
Longitud rollo / Roll Length / Longueur du Rouleau	5 M / 30 M
Vida útil / Life time / Durée de vie	75.000 H
Temperatura trabajo / Working temperature / Température de Fonctionnement	-20+50°C
Marca punto Tc / Tc Point mark / Marque de point Tc	Si / Yes / Oui
PCB / PCB	3 oz
Longitud máx. / Max length. / Longueur max.	10 M

Perfiles / Profiles / Profilés

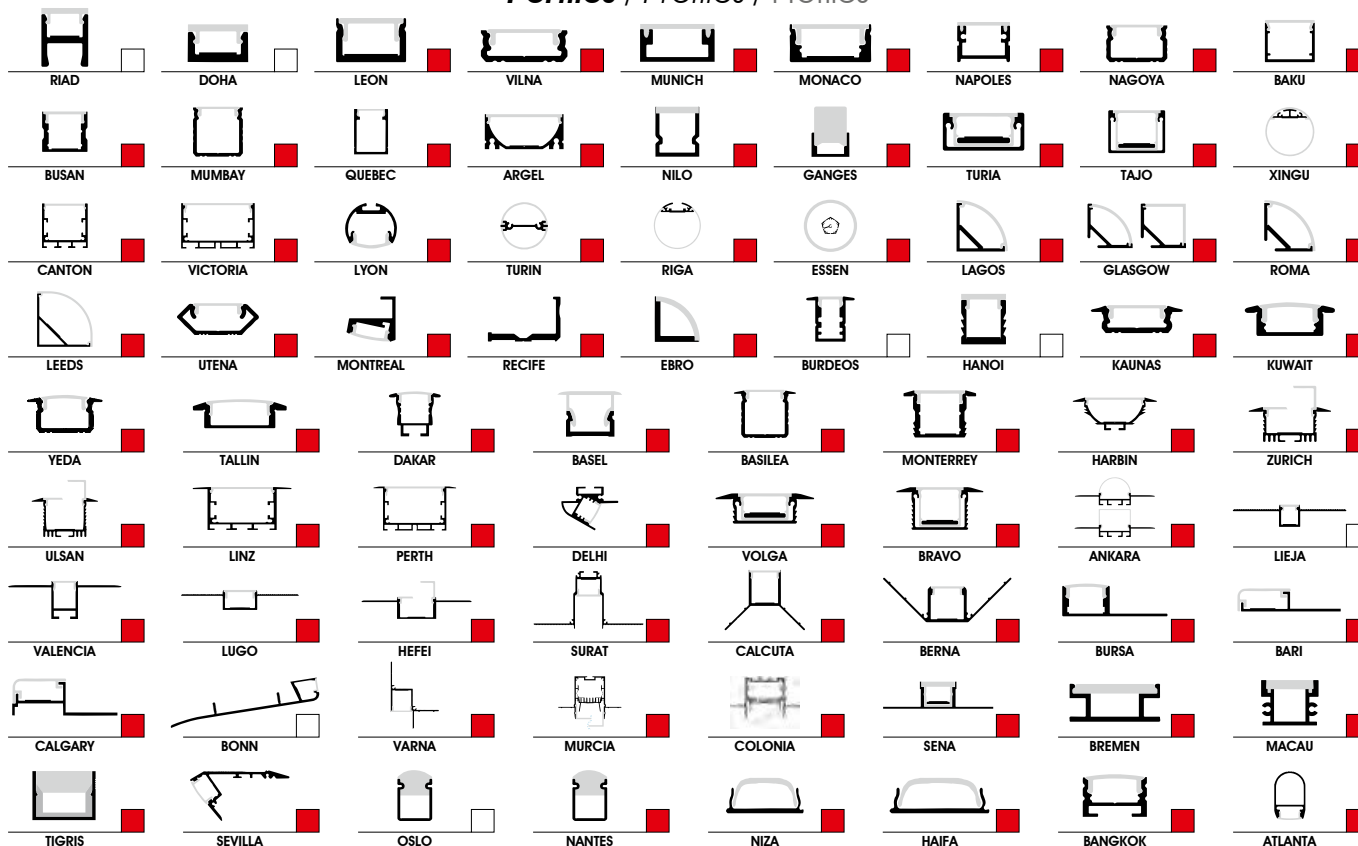

Perfil compatible con tira. / Strip compatible profile. / Profilé compatible bande. Perfil no compatible con tira. / Profile not compatible with strip. / Profilé non compatible avec la bande.

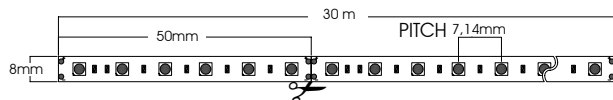

Aplicaciones: / Applications: / Applications:

Recomendada para instalaciones en uso interior. Ideal para comercios, iluminación técnica y decorativa.

Recommended for indoor installations. Ideal for shops, technical and decorative lighting.

Recommandé pour les installations intérieures. Idéal pour les magasins, l'éclairage technique et décoratif.

Importante instalar disipador de calor / Important to install heat sink / Important d'installer le dissipateur de chaleur.

Referencia Reference Référence	CCT(K)	Lumens/M	Lumens/W	PVP/M
86000	● 2200k	1240 lm/m	129 lm/W	10,95€
84000	● 2700k	1258 lm/m	131 lm/W	
84001	● 3000k	1277 lm/m	133 lm/W	
84002	○ 4000k	1296 lm/m	135 lm/W	
84003	● 6000k	1344 lm/m	140 lm/W	

TEST
LM 80

LM
79

LDT

Disipador
Heat sink
Dissipateur

LED SMD
2835

III
Clase III

Non
Flicker

3
Years
Warranty

24V

9,6
w/m

120°

10V
Vibration
CERTIFIED

GS
GREEN
SOURCE

Dimmable

-20°C
+50°C

IP20

50mm

CE

ETL

UL

RoHS

RoHS

Recycling

Características técnicas / Technical data / Caractéristiques techniques

Potencia rollo / Roll Power / Puissance de Roulis	288 W
CRI CRI	>80
Leds/m Leds/m	140LED/M
Pitch Pitch	7,14 MM
SDCM SDCM	≤3
Corte min. / Min. Cutting Length / Min. coupure	50 MM
Longitud rollo / Roll Length / Longueur du Rouleau	30 M
Vida útil / Life time / Durée de vie	75.000 H
Temperatura trabajo / Working temperature / Température de Fonctionnement	-20+50°C
Marca punto Tc / Tc Point mark / Marque de point Tc	Si / Yes / Oui
PCB PCB	3 oz
Longitud máx. / Max length. / Longueur max.	10 M

Perfiles / Profiles / Profilés

Perfil compatible con tira. / Strip compatible profile. / Profilé compatible bande. Perfil no compatible con tira. / Profile not compatible with strip. / Profilé non compatible avec la bande.

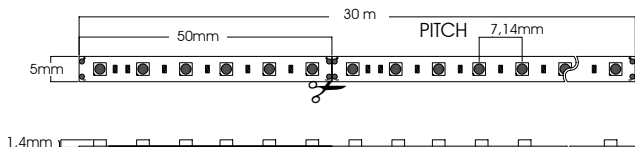

Aplicaciones: / Applications: / Applications:

Recomendada para instalaciones en uso interior. Ideal para comercios, iluminación técnica y decorativa.
 Recommended for indoor installations. Ideal for shops, technical and decorative lighting.
 Recommandé pour les installations intérieures. Idéal pour les magasins, l'éclairage technique et décoratif.

Importante instalar disipador de calor / Important to install heat sink / Important d'installer le dissipateur de chaleur.

Referencia Reference Référence	CCT(K)	Lumens/M	Lumens/W	PVP/M
86060	2700k	1404 lm/m	117 lm/W	10,95€
86061	3000k	1440 lm/m	120 lm/W	
86062	4000k	1476 lm/m	123 lm/W	
86063	6000k	1500 lm/m	125 lm/W	

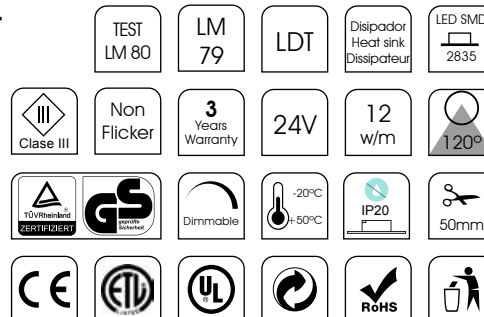

Características técnicas / Technical data / Caractéristiques techniques

Potencia rollo / Roll Power / Puissance de Roulis	360 W
CRI CRI	>80
Leds/m Leds/m	140 LED/M
Pitch Pitch	7,14 MM
SDCM SDCM	≤3
Corte min. / Min. Cutting Length / Min. coupure	50 MM
Longitud rollo / Roll Length / Longueur du Rouleau	30 M
Vida útil / Life time / Durée de vie	75.000 H
Temperatura trabajo / Working temperature / Température de Fonctionnement	-20+50°C
Marca punto Tc / Tc Point mark / Marque de point Tc	Si / Yes / Oui
PCB PCB	3 oz
Longitud máx. / Max length. / Longueur max.	10 M

Perfiles / Profiles / Profilés

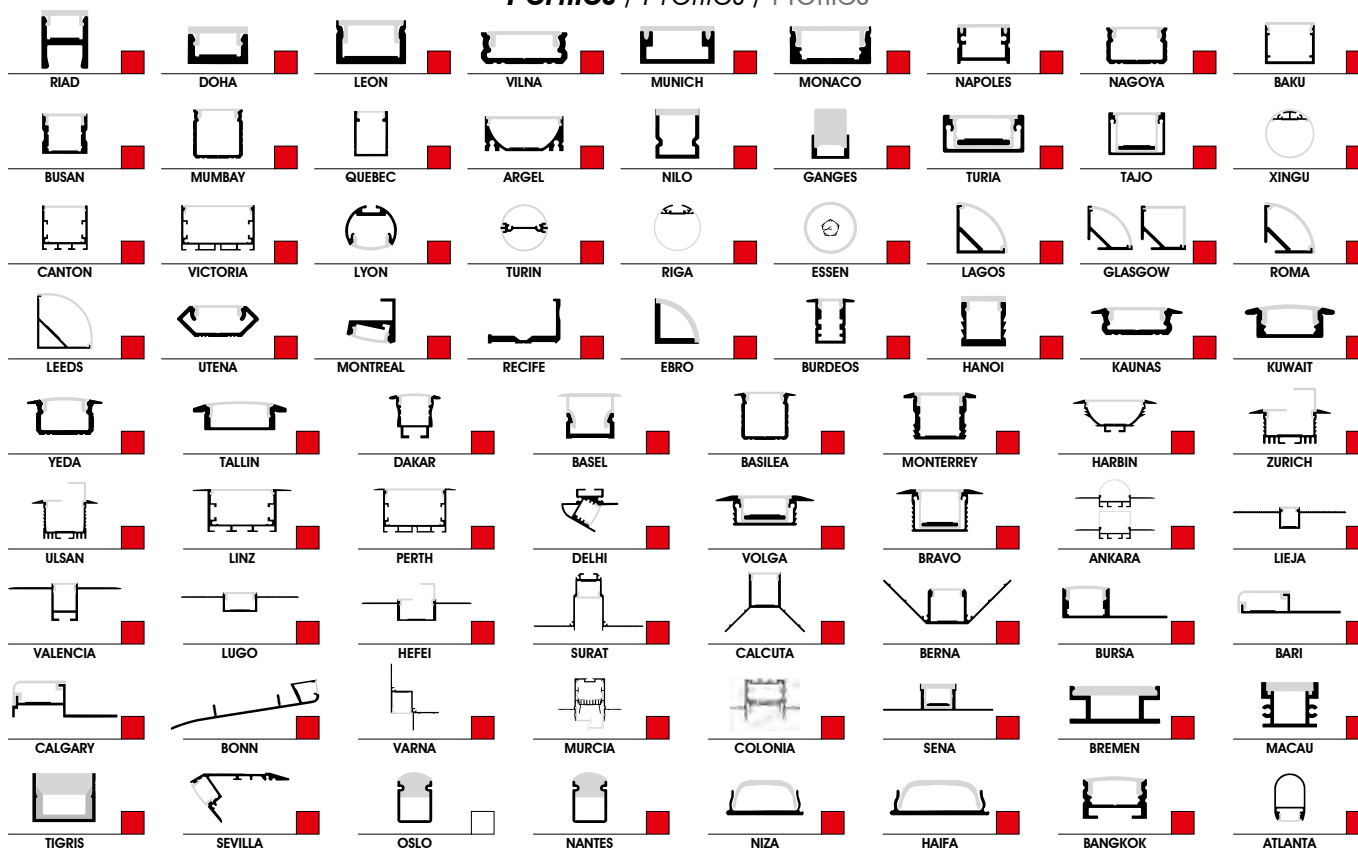

■ Perfil compatible con tira. / Strip compatible profile. / Profilé compatible bande. □ Perfil no compatible con tira. / Profile not compatible with strip. / Profilé non compatible avec la bande.

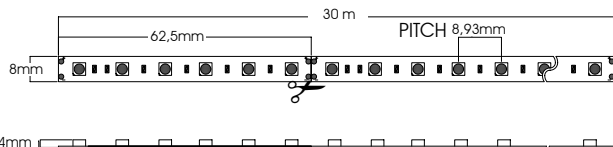

Aplicaciones: / Applications: / Applications:

Recomendada para instalaciones en uso interior. Ideal para comercios, iluminación técnica y decorativa.
 Recommended for indoor installations. Ideal for shops, technical and decorative lighting.
 Recommandé pour les installations intérieures. Idéal pour les magasins, l'éclairage technique et décoratif.

Importante instalar disipador de calor / Important to install heat sink / Important d'installer le dissipateur de chaleur.

Referencia Reference Référence	CCT(K)	Lumens/M	Lumens/W	PVP/M
86031	2700k	1560 lm/m	130 lm/W	11,95€
80032	3000k	1600 lm/m	133 lm/W	
80033	4000k	1640 lm/m	136 lm/W	
80034	6000k	1680 lm/m	140 lm/W	

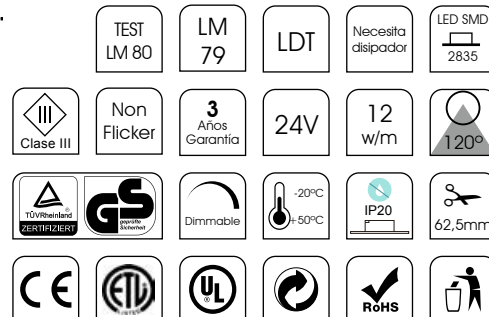

Características técnicas / Technical data / Caractéristiques techniques

Potencia rollo / Roll Power / Puissance de Roulis	360 W
CRI CRI	>80
Leds/m Leds/m	112 LED/M
Pitch Pitch	8,93 MM
SDCM SDCM	≤3
Corte min. / Min. Cutting Length / Min. coupure	62,5 MM
Longitud rollo / Roll Length / Longueur du Rouleau	30 M
Vida útil / Life time / Durée de vie	75.000 H
Temperatura trabajo / Working temperature / Température de Fonctionnement	-20+50°C
Marca punto Tc / Tc Point mark / Marque de point Tc	Si / Yes / Oui
PCB PCB	3 oz
Longitud máx. / Max length. / Longueur max.	10 M

Perfiles / Profiles / Profilés

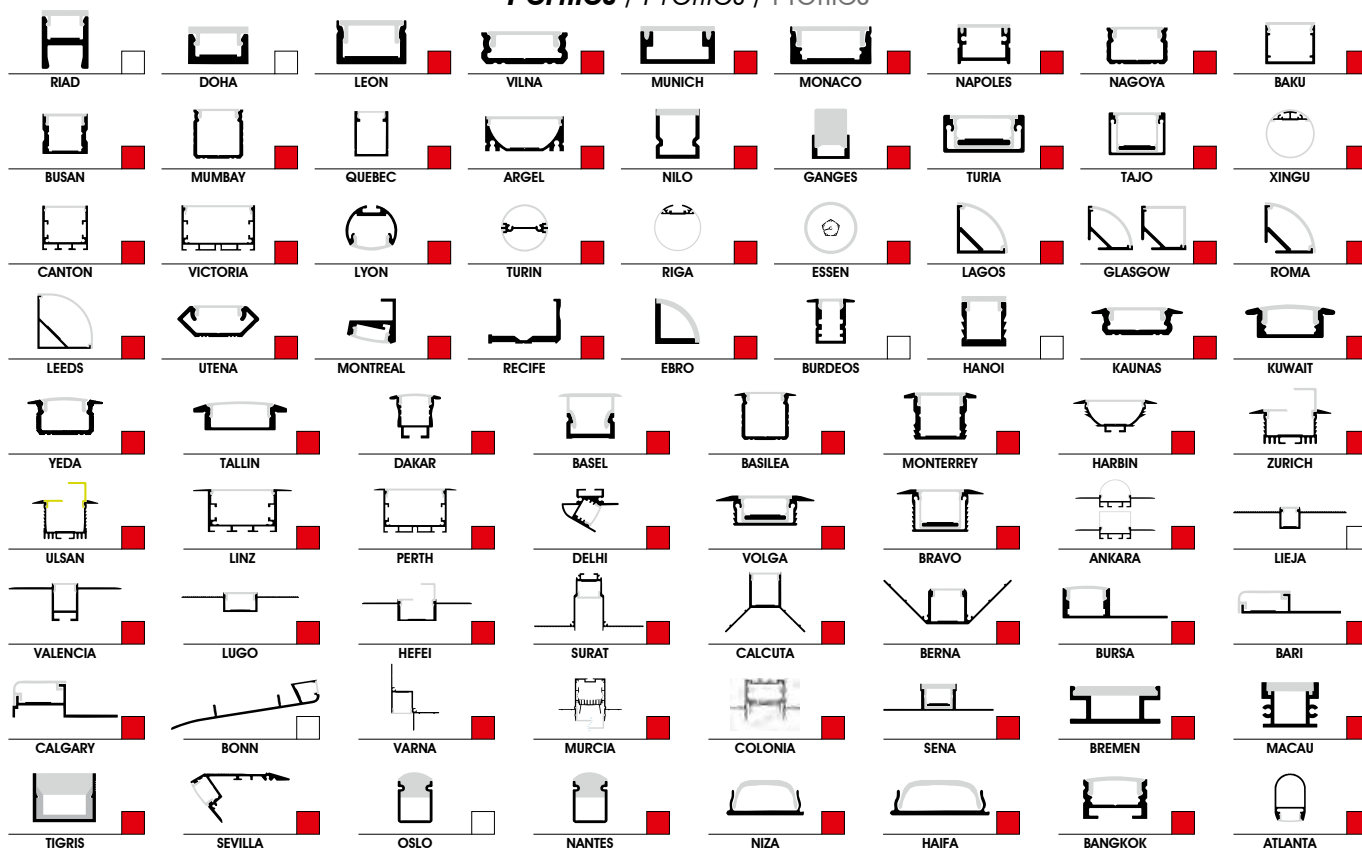

■ Perfil compatible con tira. / Strip compatible profile. / Profilé compatible bande. □ Perfil no compatible con tira. / Profile not compatible with strip. / Profilé non compatible avec la bande.

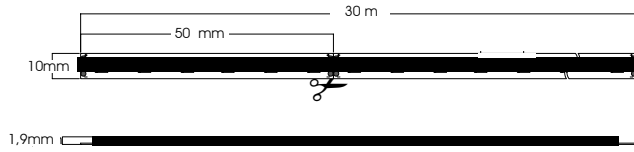

Aplicaciones: / Applications: / Applications:

Recomendada para instalaciones en uso interior. Ideal para comercios, iluminación técnica y decorativa.

Recommended for indoor installations. Ideal for shops, technical and decorative lighting.

Recommandé pour les installations intérieures. Idéal pour les magasins, l'éclairage technique et décoratif.

Importante instalar disipador de calor / Important to install heat sink / Important d'installer le dissipateur de chaleur.

Referencia Reference Référence	CCT(K)	Lumens/M	Lumens/W	PVP/M
86079	● 2200k	1000 lm/m	84 lm/W	14,95€
84080	● 2700k	1050 lm/m	88 lm/W	
84081	● 3000k	1120 lm/m	93 lm/W	
84082	○ 4000k	1200 lm/m	100 lm/W	
84083	● 6000k	1280 lm/m	106 lm/W	

TEST LM 80

LM 79

LDT

Necesita disipador

LED COB

Class III

Non Flicker

3 Años Garantía

24V

12 w/m

140°

100% Standard ZERTIFIZIERT

GS

Dimmable

-20°C -50°C

IP20

50mm

CE

EUTM

UL

RoHS

RoHS

RoHS

Características técnicas / Technical data / Caractéristiques techniques

Potencia rollo / Roll Power / Puissance de Roulis	360 W
CRI CRI	>80
Leds/m Leds/m	480 LED/M
Pitch Pitch	Led continuo / Continuous led / Led continue
SDCM SDCM	≤3
Corte min. / Min. Cutting Length / Min. coupure	50 MM
Longitud rollo / Roll Length / Longueur du Rouleau	30 M
Vida útil / Life time / Durée de vie	75.000 H
Temperatura trabajo / Working temperature / Température de Fonctionnement	-20+50°C
Marca punto Tc / Tc Point mark / Marque de point Tc	Si / Yes / Oui
PCB PCB	3 oz
Longitud máx. / Max length. / Longueur max.	10 M

Perfiles / Profiles / Profilés

RIAD	DOHA	LEON	VILNA	MUNICH	MONACO	NAPOLIS	NAGOYA	BAKU
BUSAN	MUMBAI	QUEBEC	ARGEL	NILO	GANGES	TURIA	TAJO	XINGU
CANTON	VICTORIA	LYON	TURIN	RIGA	ESSEN	LAGOS	GLASGOW	ROMA
LEEDS	UTENA	MONTREAL	RECIFE	EBRO	BURDEOS	HANOI	KAUNAS	KUWAIT
YEDA	TALLIN	DAKAR	BASEL	BASILEA	MONTERREY	HARBIN	ZURICH	
ULSAN	LINZ	PERTH	DELHI	VOLGA	BRAVO	ANKARA	LIEJA	
VALENCIA	LUGO	HEFEI	SURAT	CALCUTA	BERNA	BURSA	BARI	
CALGARY	BONN	VARNA	MURCIA	COLONIA	SENNA	BREMEN	MACAU	
TIGRIS	SEVILLA	OSLO	NANTES	NIZA	HAIFA	BANGKOK	ATLANTA	

Perfil compatible con tira. / Strip compatible profile. / Profilé compatible bande. Perfil no compatible con tira. / Profile not compatible with strip. / Profilé non compatible avec la bande.

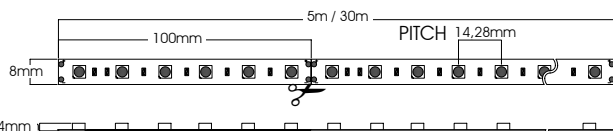

Aplicaciones: / Applications: / Applications:

Recomendada para instalaciones en uso interior. Ideal para comercios, iluminación técnica

Recommended for indoor installations. Ideal for shops, technical and decorative lighting.

Recommandé pour les installations intérieures. Idéal pour les magasins, l'éclairage technique et décoratif.

Importante instalar disipador de calor / Important to install heat sink / Important d'installer le dissipateur de chaleur.

Referencia Reference Référence	CCT(K)	Lumens/M	Lumens/W	PVP
84410	2700k	1325 lm/m	92 lm/W	5,95€ / M
84411	3000k	1354 lm/m	94 lm/W	
84412	4000k	1397 lm/m	97 lm/W	
84413	6000k	1440 lm/m	100 lm/W	
84415	2700k	1325 lm/m	92 lm/W	
84416	3000k	1354 lm/m	94 lm/W	28,95€ / 5M
84417	4000k	1397 lm/m	97 lm/W	
84418	6000k	1440 lm/m	100 lm/W	

Características técnicas / Technical data / Caractéristiques techniques

Potencia rollo / Roll Power / Puissance de Roulis	72 W / 432 W
CRI / CRI	>80
Leds/m Leds/m	70 LED/M
Pitch / Pitch	14,28 MM
SDCM / SDCM	≤3
Corte min. / Min. Cutting Length / Min. coupure	100 MM
Longitud rollo / Roll Length / Longueur du Rouleau	5 M / 30 M
Vida útil / Life time / Durée de vie	75.000 H
Temperatura trabajo / Working temperature / Température de Fonctionnement	-20+50°C
Marca punto Tc / Tc Point mark / Marque de point Tc	Si / Yes / Oui
PCB / PCB	3 oz
Longitud máx. / Max length. / Longueur max.	10 M

Perfiles / Profiles / Profilés

■ Perfil compatible con tira. / Strip compatible profile. / Profilé compatible bande. □ Perfil no compatible con tira. / Profile not compatible with strip. / Profilé non compatible avec la bande.

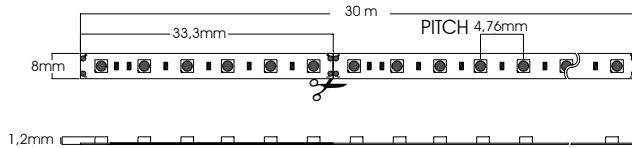

Aplicaciones: / Applications: / Applications:

Recomendada para instalaciones en uso interior. Ideal para comercios, iluminación técnica y decorativa.
 Recommended for indoor installations. Ideal for shops, technical and decorative lighting.
 Recommandé pour les installations intérieures. Idéal pour les magasins, l'éclairage technique et décoratif.

Importante instalar disipador de calor / Important to install heat sink / Important d'installer le dissipateur de chaleur.

Referencia Reference Référence	CCT(K)	Lumens/M	Lumens/W	PVP/M
86006	2200k	1800 lm/m	125 lm/W	14,95€
84007	2700k	1886 lm/m	131 lm/W	
84008	3000k	1915 lm/m	133 lm/W	
84009	4000k	1959 lm/m	135 lm/W	
84010	6000k	2016 lm/m	140 lm/W	

TEST LM 80

LM 79

LDT

Disipador Heat sink Dissipateur

LED SMD 2835

Class III

Non Flicker

3 Años Garantía

24V

14,4 w/m

120°

TÜV Rheinland CERTIFIED

GS

Dimmable

-20°C -60°C

IP20

33,3mm

CE

ETL

UL

RoHS

Recycling symbol

Características técnicas / Technical data / Caractéristiques techniques

Potencia rollo / Roll Power / Puissance de Roulis	432 W
CRI CRI	>80
Leds/m Leds/m	210 LED/M
Pitch Pitch	4,76 MM
SDCM SDCM	≤3
Corte min. / Min. Cutting Length / Min. coupure	33,3 MM
Longitud rollo / Roll Length / Longueur du Rouleau	30 M
Vida útil / Life time / Durée de vie	75.000 H
Temperatura trabajo / Working temperature / Température de Fonctionnement	-20+50°C
Marca punto Tc / Tc Point mark / Marque de point Tc	Si / Yes / Oui
PCB PCB	3 oz
Longitud máx. / Max length. / Longueur max.	10 M

Perfiles / Profiles / Profilés

RIAD	DOHA	LEON	VILNA	MUNICH	MONACO	NAPOLIS	NAGOYA	BAKU
BUSAN	MUMBAI	QUEBEC	ARGEL	NILO	GANGES	TURIA	TAJO	XINGU
CANTON	VICTORIA	LYON	TURIN	RIGA	ESSEN	LAGOS	GLASGOW	ROMA
LEEDS	UTENA	MONTREAL	RECIFE	EBRO	BURDEOS	HANOI	KAUNAS	KUWAIT
YEDA	TALLIN	DAKAR	BASEL	BASILEA	MONTERREY	HARBIN	ZURICH	
ULSAN	LINZ	PERTH	DELHI	VOLGA	BRAVO	ANKARA	LIEJA	
VALENCIA	LUGO	HEFEI	SURAT	CALCUTA	BERNA	BURSA	BARI	
CALGARY	BONN	VARNA	MURCIA	COLONIA	SENNA	BREMEN	MACAU	
TIGRIS	SEVILLA	OSLO	NANTES	NIZA	HAIFA	BANGKOK	ATLANTA	

Perfil compatible con tira. / Strip compatible profile. / Profilé compatible bande. Perfil no compatible con tira. / Profile not compatible with strip. / Profilé non compatible avec la bande.

ARIZONA 17w/m · IP20 · 24v · Cri>80

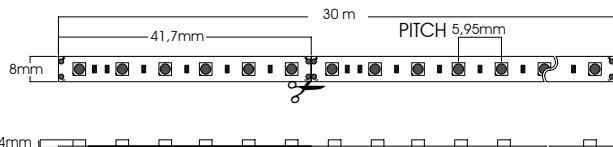

Aplicaciones: / Applications: / Applications:

Recomendada para instalaciones en uso interior. Ideal para comercios, iluminación técnica y decorativa.
Recommended for indoor installations. Ideal for shops, technical and decorative lighting.
Recommandé pour les installations intérieures. Idéal pour les magasins, l'éclairage technique et décoratif.

Importante instalar disipador de calor / Important to install heat sink / Important d'installer le dissipateur de chaleur.

Referencia Reference Référence	CCT(K)	Lumens/M	Lumens/W	PVP/M
86037	2700k	2210 lm/m	130 lm/W	15,95€
80038	3000k	2270 lm/m	133 lm/W	
80039	4000k	2320 lm/m	136 lm/W	
80040	6000k	2380 lm/m	140 lm/W	



Características técnicas / Technical data / Caractéristiques techniques

Potencia rollo / Roll Power / Puissance de Roulis	510 W
CRI CRI	>80
Leds/m Leds/m	168 LED/M
Pitch Pitch	5,95 MM
SDCM SDCM	≤3
Corte min. / Min. Cutting Length / Min. coupure	41,7 MM
Longitud rollo / Roll Length / Longueur du Rouleau	30 M
Vida útil / Life time / Durée de vie	75.000 H
Temperatura trabajo / Working temperature / Température de Fonctionnement	-20+50°C
Marca punto Tc / Tc Point mark / Marque de point Tc	Si / Yes / Oui
PCB PCB	3 oz
Longitud máx. / Max length. / Longueur max.	10 M

Perfiles / Profiles / Profilés

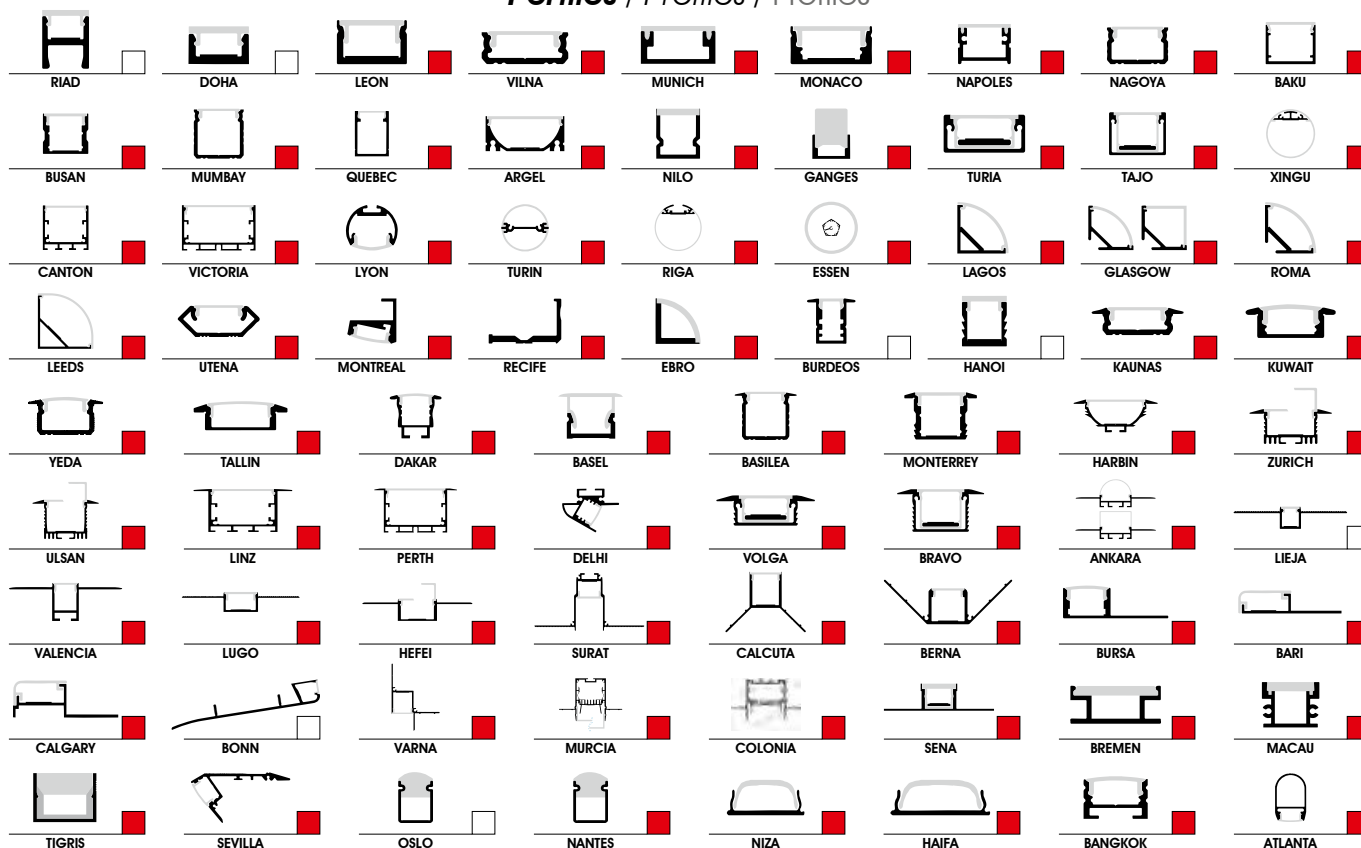

■ Perfil compatible con tira. / Strip compatible profile. / Profilé compatible bande. □ Perfil no compatible con tira. / Profile not compatible with strip. / Profilé non compatible avec la bande.

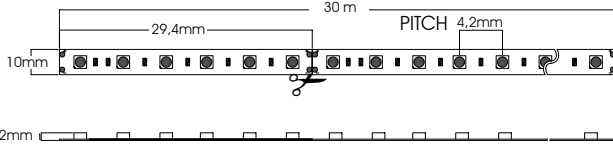

Aplicaciones: / Applications: / Applications:

Recomendada para instalaciones en uso interior. Ideal para comercios, iluminación técnica y decorativa.
 Recommended for indoor installations. Ideal for shops, technical and decorative lighting.
 Recommandé pour les installations intérieures. Idéal pour les magasins, l'éclairage technique et décoratif.

Importante instalar disipador de calor / Important to install heat sink / Important d'installer le dissipateur de chaleur.

Referencia Reference Référence	CCT(K)	Lumens/M	Lumens/W	PVP/M
84014	2700k	2515 lm/m	131 lm/W	17,95€
84015	3000k	2553 lm/m	133 lm/W	
84016	4000k	2592 lm/m	135 lm/W	
84017	6000k	2688 lm/m	140 lm/W	

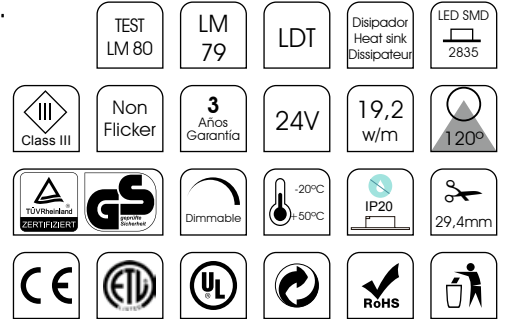

Características técnicas / Technical data / Caractéristiques techniques

Potencia rollo / Roll Power / Puissance de Roulis	576 W
CRI CRI	>80
Leds/m Leds/m	238 LED/M
Pitch Pitch	4,2 MM
SDCM SDCM	≤3
Corte min. / Min. Cutting Length / Min. coupure	29,4 MM
Longitud rollo / Roll Length / Longueur du Rouleau	30 M
Vida útil / Life time / Durée de vie	75.000 H
Temperatura trabajo / Working temperature / Température de Fonctionnement	-20+50°C
Marca punto Tc / Tc Point mark / Marque de point Tc	Si / Yes / Oui
PCB PCB	3 oz
Longitud máx. / Max length. / Longueur max.	10 M

Perfiles / Profiles / Profilés

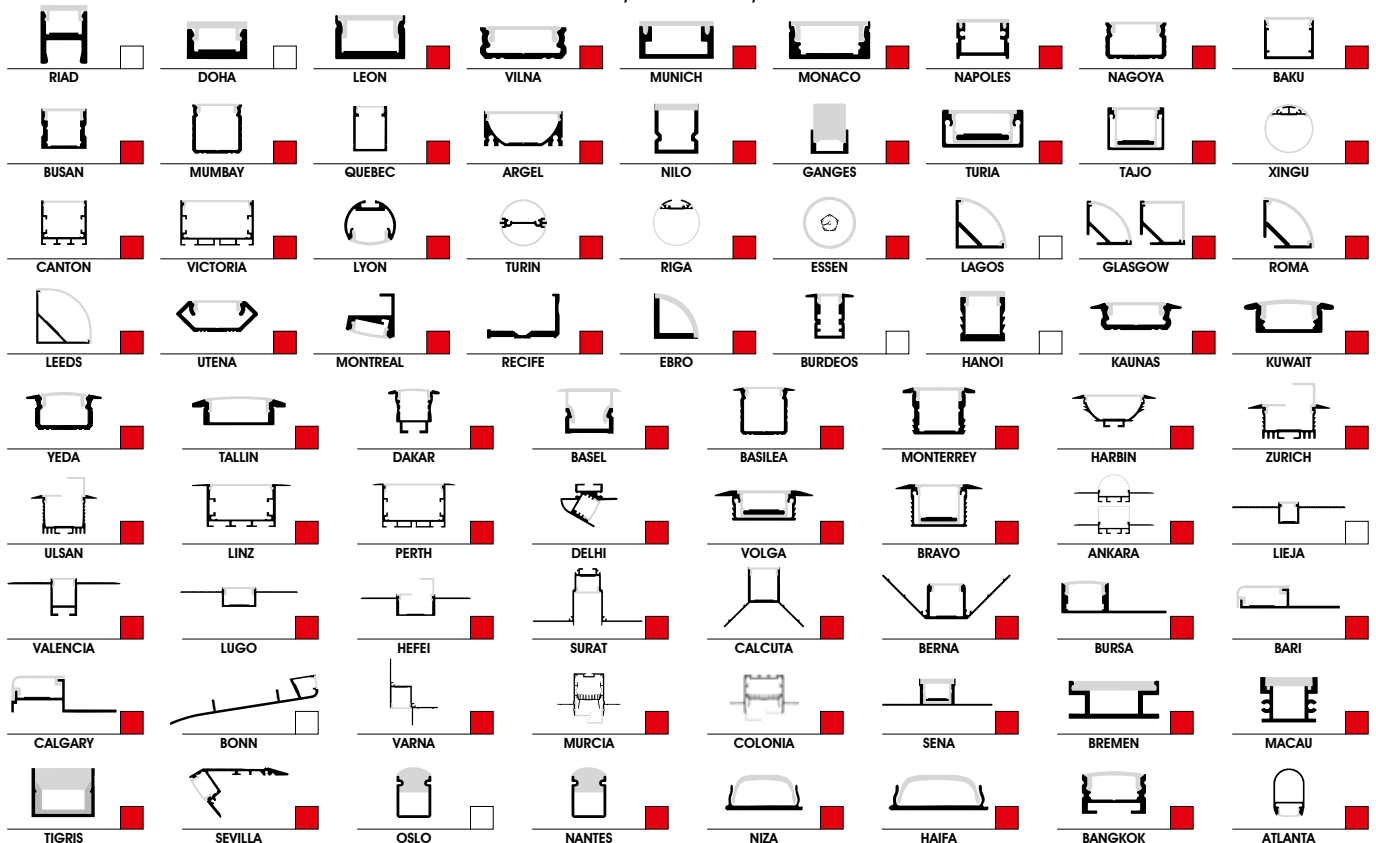

■ Perfil compatible con tira. / Strip compatible profile. / Profilé compatible bande. □ Perfil no compatible con tira. / Profile not compatible with strip. / Profilé non compatible avec la bande.

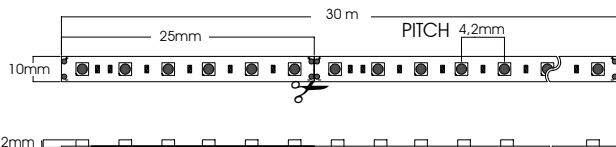

Aplicaciones: / Applications: / Applications:

Recomendada para instalaciones en uso interior. Ideal para comercios, iluminación técnica y decorativa.
 Recommended for indoor installations. Ideal for shops, technical and decorative lighting.
 Recommandé pour les installations intérieures. Idéal pour les magasins, l'éclairage technique et décoratif.

Importante instalar disipador de calor / Important to install heat sink / Important d'installer le dissipateur de chaleur.

Referencia Reference Référence	CCT(K)	Lumens/M	Lumens/W	PVP/M
84021	2700k	2640 lm/m	110 lm/W	18.95€
84022	3000k	2688 lm/m	112 lm/W	
84023	4000k	2760 lm/m	115 lm/W	
84024	6000k	2880 lm/m	120 lm/W	

Características técnicas / Technical data / Caractéristiques techniques

Potencia rollo / Roll Power / Puissance de Roulis	720 W
CRI CRI	>80
Leds/m Leds/m	240 LED/M
Pitch Pitch	4,2 MM
SDCM SDCM	≤3
Corte min. / Min. Cutting Length / Min. coupure	25 MM
Longitud rollo / Roll Length / Longueur du Rouleau	30 M
Vida útil / Life time / Durée de vie	75.000 H
Temperatura trabajo / Working temperature / Température de Fonctionnement	-20+50°C
Marca punto Tc / Tc Point mark / Marque de point Tc	Si / Yes / Oui
PCB PCB	3 oz
Longitud máx. / Max length. / Longueur max.	10 M

Perfiles / Profiles / Profilés

■ Perfil compatible con tira. / Strip compatible profile. / Profilé compatible bande. □ Perfil no compatible con tira. / Profile not compatible with strip. / Profilé non compatible avec la bande.

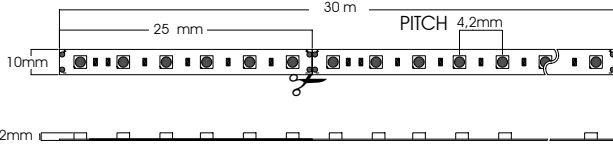

Aplicaciones: / Applications: / Applications:

Recomendada para instalaciones en uso interior. Ideal para comercios, iluminación técnica y decorativa.

Recommended for indoor installations. Ideal for shops, technical and decorative lighting.

Recommandé pour les installations intérieures. Idéal pour les magasins, l'éclairage technique et décoratif.

Importante instalar disipador de calor / Important to install heat sink / Important d'installer le dissipateur de chaleur.

Referencia Reference Référence	CCT(K)	Lumens/M	Lumens/W	PVP/M
84028	2700k	4800 lm/m	100 lm/W	21,95€
84029	3000k	4992 lm/m	104 lm/W	
84030	4000k	5088 lm/m	106 lm/W	
84031	6000k	5280 lm/m	110 lm/W	

TEST LM 80

LM 79

LDT

Disipador Heat sink Dissipateur

LED SMD 2835

Class III

Non Flicker

3 Años Garantía

24V

48 w/m

120°

TÜV Rheinland CERTIFIZIERT

GS

Dimmable

-20°C -50°C

IP20

25mm

CE

ETL

UL

RoHS

Recycling symbol

Características técnicas / Technical data / Caractéristiques techniques

Potencia rollo / Roll Power / Puissance de Roulis	1440 W
CRI CRI	>80
Leds/m Leds/m	240 LED/M
Pitch Pitch	4,2 MM
SDCM SDCM	≤3
Corte min. / Min. Cutting Length / Min. coupure	25 MM
Longitud rollo / Roll Length / Longueur du Rouleau	30 M
Vida útil / Life time / Durée de vie	75.000 H
Temperatura trabajo / Working temperature / Température de Fonctionnement	-20+50°C
Marca punto Tc / Tc Point mark / Marque de point Tc	Si / Yes / Oui
PCB PCB	3 oz
Longitud máx. / Max length. / Longueur max.	10 M

Perfiles / Profiles / Profilés

Perfil compatible con tira. / Strip compatible profile. / Profilé compatible bande. Perfil no compatible con tira. / Profile not compatible with strip. / Profilé non compatible avec la bande.

MADISON RGB 12w/m COB · IP20 · 24v · Cri>90

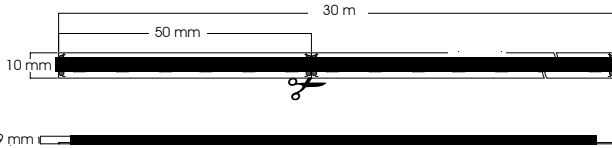

Aplicaciones: / Applications: / Applications:

Recomendada para instalaciones en uso interior. Ideal para comercios, iluminación técnica y decorativa.

Recommended for indoor installations. Ideal for shops, technical and decorative lighting.

Recommandé pour les installations intérieures. Idéal pour les magasins, l'éclairage technique et décoratif.

Importante instalar disipador de calor / Important to install heat sink / Important d'installer le dissipateur de chaleur.

Referencia Référence Référence	CCT(K)	Lumens/M	PVP/M
86050	RGB (Multicolor)	495 lm/m	19,95€
		Rojo 100 lm/m	
		Verde 275 lm/m	
		Azul 85 lm/m	



Características técnicas / Technical data / Caractéristiques techniques

Potencia rollo / Roll Power / Puissance de Roulis	360 W
CRI CRI	>90
Leds/m Leds/m	840 LED/M
Pitch Pitch	Led continuo / Continuous led / Led continue
SDCM SDCM	≤3
Corte min. / Min. Cutting Length / Min. coupure	50 MM
Longitud rollo / Roll Length / Longueur du Rouleau	30 M
Vida útil / Life time / Durée de vie	75.000 H
Temperatura trabajo / Working temperature / Température de Fonctionnement	-20+50°C
Marca punto Tc / Tc Point mark / Marque de point Tc	Si / Yes / Oui
PCB PCB	3 oz
Longitud máx. / Max length. / Longueur max.	10 M

Perfiles / Profiles / Profilés

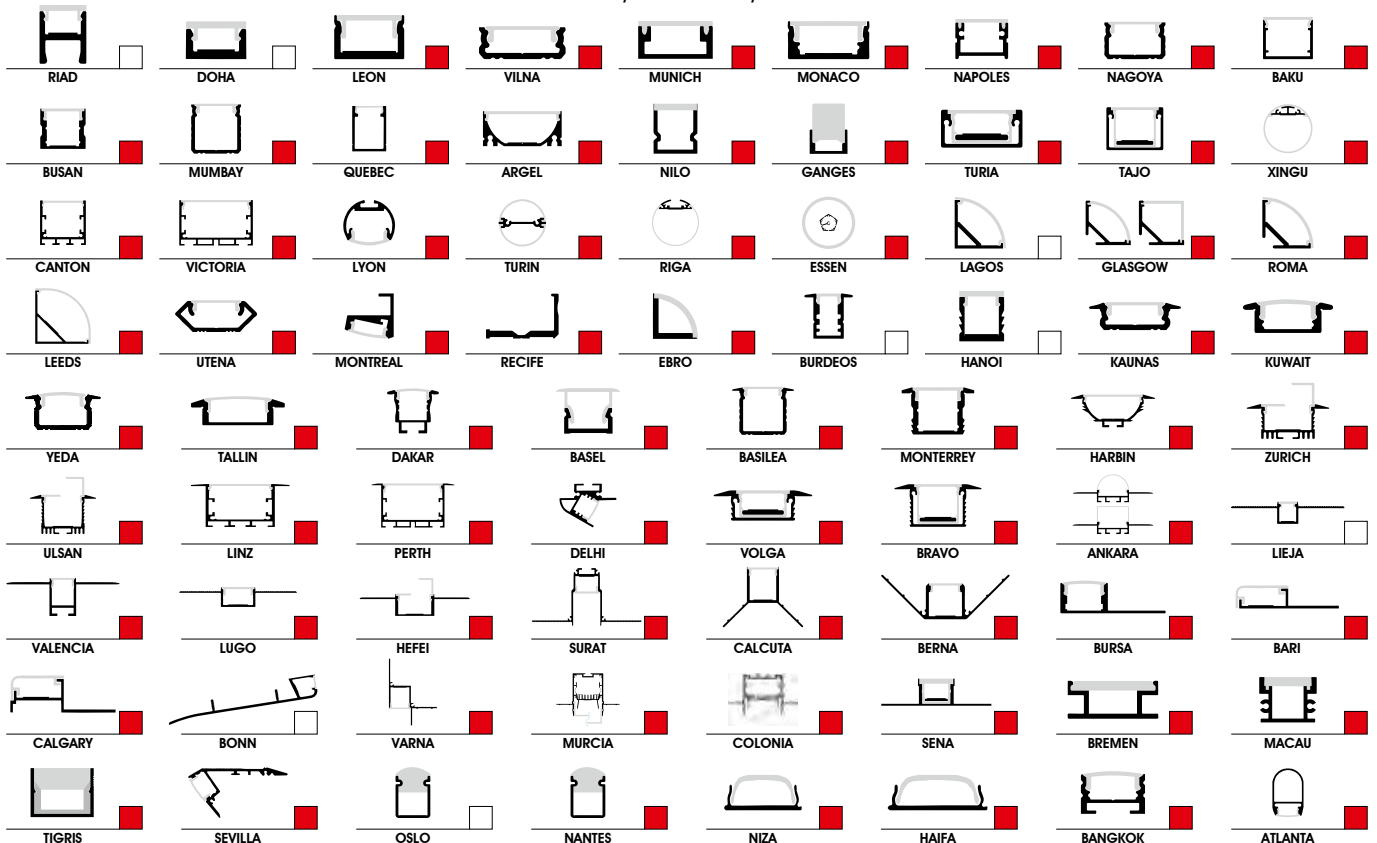

■ Perfil compatible con tira. / Strip compatible profile. / Profilé compatible bande. □ Perfil no compatible con tira. / Profile not compatible with strip. / Profilé non compatible avec la bande.

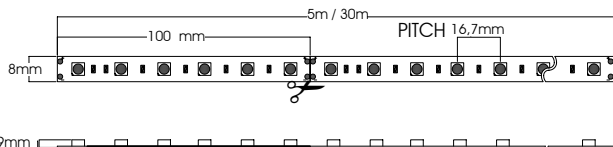

Aplicaciones: / Applications: / Applications:

Recomendada para instalaciones en uso interior. Ideal para comercios, iluminación técnica y decorativa.
 Recommended for indoor installations. Ideal for shops, technical and decorative lighting.
 Recommandé pour les installations intérieures. Idéal pour les magasins, l'éclairage technique et décoratif.

Importante instalar disipador de calor / Important to install heat sink / Important d'installer le dissipateur de chaleur.

Referencia Reference Référence	CCT(K)	Lumens/M	PVP
84470	RGB (Multicolor)	540 lm/m	9,95€ / M
		Rojo 108 lm/m	
		Verde 297 lm/m	
84472		Azul 90 lm/m	48,95€ / 5M

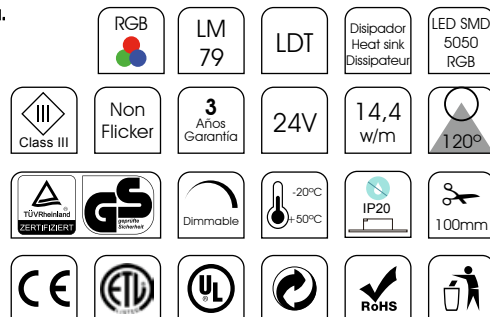

Características técnicas / Technical data / Caractéristiques techniques

Potencia rollo / Roll Power / Puissance de Roulis	72 W / 432 W
CRI CRI	>80
Leds/m Leds/m	60 LED/M
Pitch Pitch	16,7 MM
SDCM SDCM	≤3
Corte min. / Min. Cutting Length / Min. coupure	100 MM
Longitud rollo / Roll Length / Longueur du Rouleau	5 M / 30 M
Vida útil / Life time / Durée de vie	75.000 H
Temperatura trabajo / Working temperature / Température de Fonctionnement	-20+50°C
Marca punto Tc / Tc Point mark / Marque de point Tc	Si / Yes / Oui
PCB PCB	3 oz
Longitud máx. / Max length. / Longueur max.	10 M

Perfiles / Profiles / Profilés

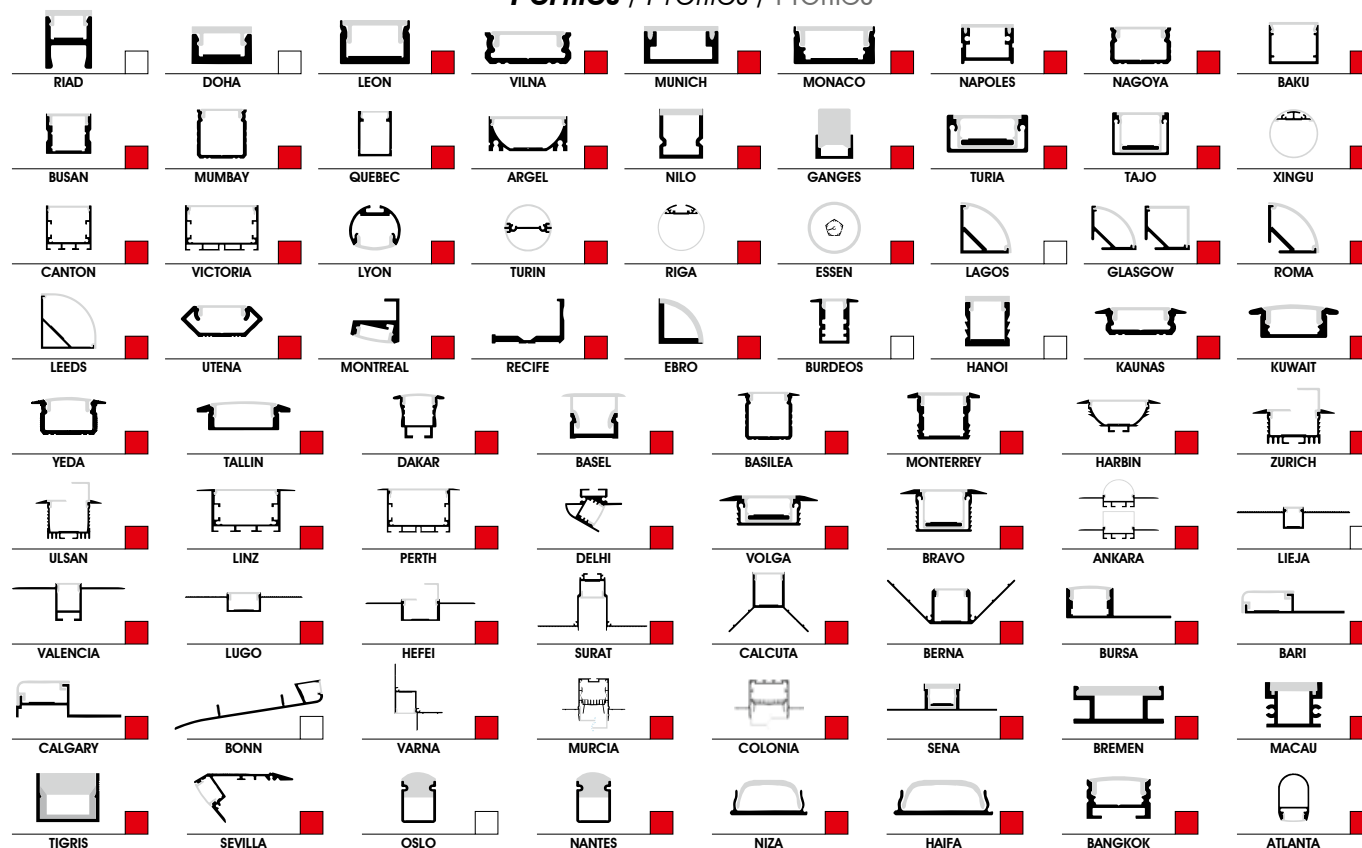

■ Perfil compatible con tira. / Strip compatible profile. / Profilé compatible bande. □ Perfil no compatible con tira. / Profile not compatible with strip. / Profilé non compatible avec la bande.

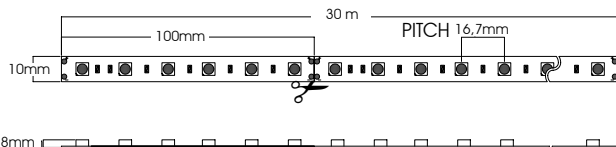

Aplicaciones: / Applications: / Applications:

Recomendada para instalaciones en uso interior. Ideal para comercios, iluminación técnica y decorativa.
 Recommended for indoor installations. Ideal for shops, technical and decorative lighting.
 Recommandé pour les installations intérieures. Idéal pour les magasins, l'éclairage technique et décoratif.

Importante instalar disipador de calor / Important to install heat sink / Important d'installer le dissipateur de chaleur.

Referencia Reference Référence	CCT(K)	Lumens/M	PVP/M
84045	RGB (Multicolor)	600 lm/m	12,95€
		Rojo 120 lm/m	
		Verde 330 lm/m	
		Azul 100 lm/m	

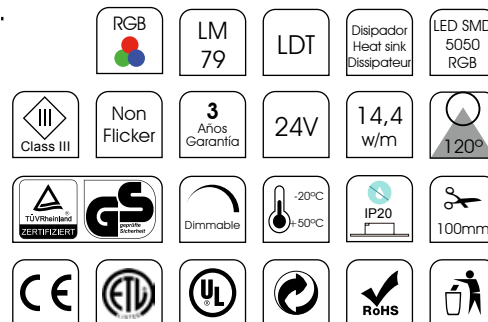

Características técnicas / Technical data / Caractéristiques techniques

Potencia rollo / Roll Power / Puissance de Roulis	360 W
CRI CRI	>80
Leds/m Leds/m	60 LED/M
Pitch Pitch	16,7 MM
SDCM SDCM	≤3
Corte min. / Min. Cutting Length / Min. coupure	100 MM
Longitud rollo / Roll Length / Longueur du Rouleau	30 M
Vida útil / Life time / Durée de vie	75.000 H
Temperatura trabajo / Working temperature / Température de Fonctionnement	-20+50°C
Marca punto Tc / Tc Point mark / Marque de point Tc	Si / Yes / Oui
PCB PCB	3 oz
Longitud máx. / Max length. / Longueur max.	10 M

Perfiles / Profiles / Profilés

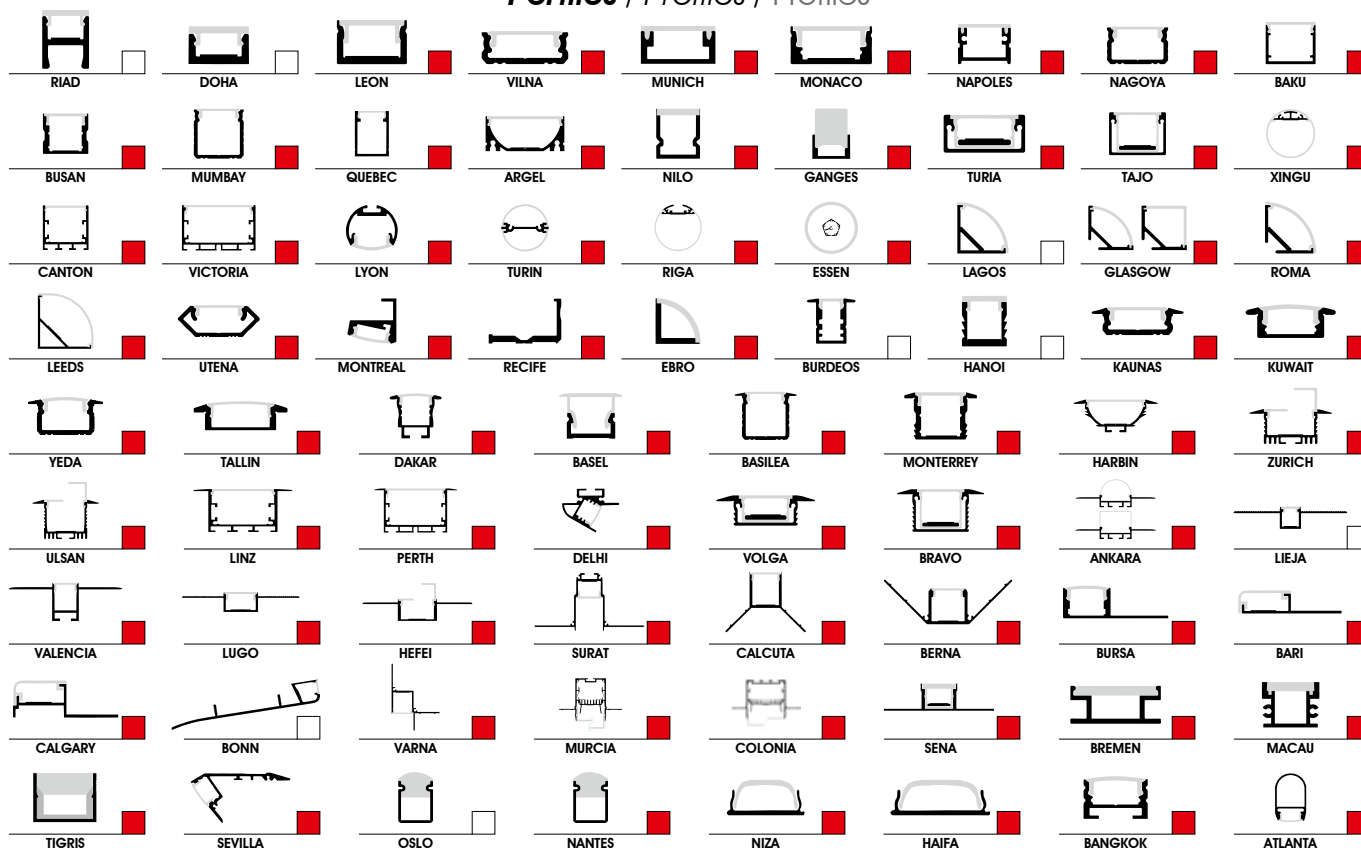

■ Perfil compatible con tira. / Strip compatible profile. / Profilé compatible bande. □ Perfil no compatible con tira. / Profile not compatible with strip. / Profilé non compatible avec la bande.

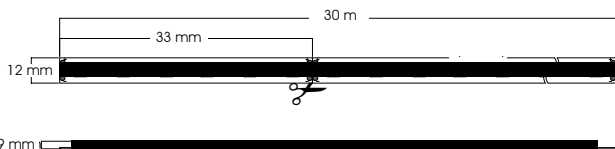

Aplicaciones: / Applications: / Applications:

Recomendada para instalaciones en uso interior. Ideal para comercios, iluminación técnica y decorativa.
 Recommended for indoor installations. Ideal for shops, technical and decorative lighting.
 Recommandé pour les installations intérieures. Idéal pour les magasins, l'éclairage technique et décoratif.

Importante instalar disipador de calor / Important to install heat sink / Important d'installer le dissipateur de chaleur.

Referencia Reference Référence	CCT(K)	Lumens/M	PVP/M
86052	RGBW3000K	860 lm/m	22,95€
86053	RGBW4000K	900 lm/m	

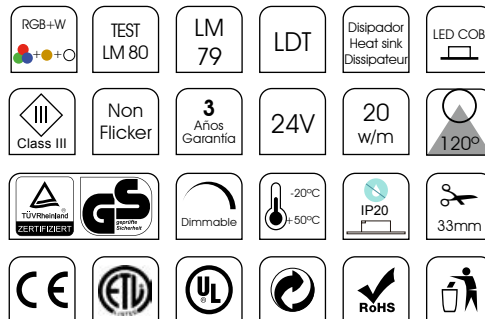

Características técnicas / Technical data / Caractéristiques techniques

Potencia rollo / Roll Power / Puissance de Roulis	600 W
CRI CRI	>90
Leds/m Leds/m	840 LED/M
Pitch Pitch	Led continuo / Continuous led / Led continue
SDCM SDCM	≤3
Corte min. / Min. Cutting Length / Min. coupure	33 MM
Longitud rollo / Roll Length / Longueur du Rouleau	30 M
Vida útil / Life time / Durée de vie	75.000 H
Temperatura trabajo / Working temperature / Température de Fonctionnement	-20+50°C
Marca punto Tc / Tc Point mark / Marque de point Tc	Si / Yes / Oui
PCB PCB	3 oz
Longitud máx. / Max length. / Longueur max.	10 M

Perfiles / Profiles / Profilés

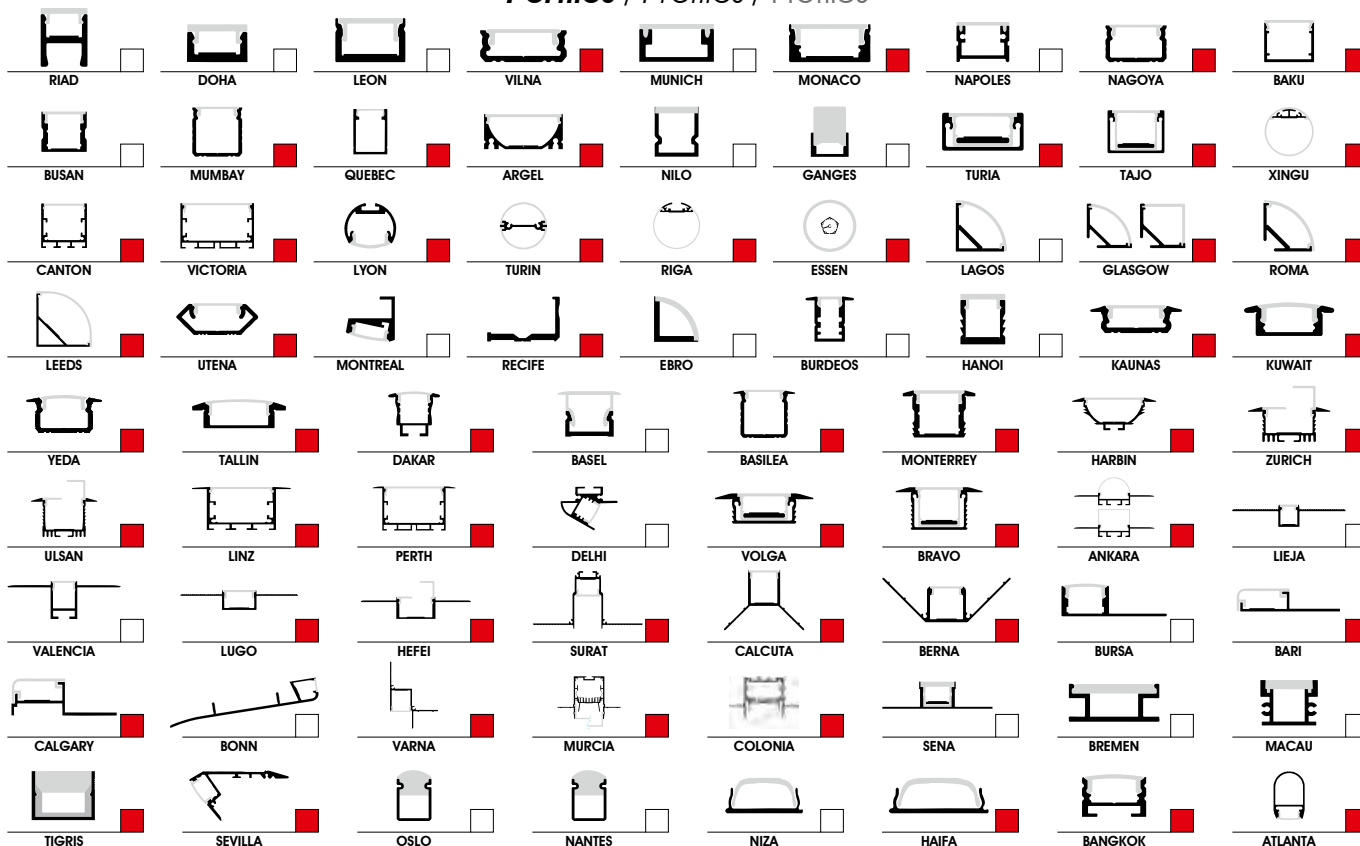

■ Perfil compatible con tira. / Strip compatible profile. / Profilé compatible bande. □ Perfil no compatible con tira. / Profile not compatible with strip. / Profilé non compatible avec la bande.

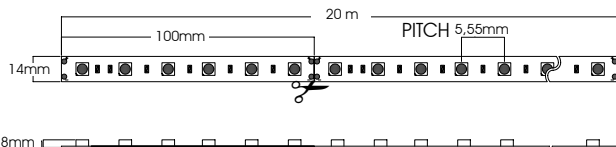

Aplicaciones: / Applications: / Applications:

Recomendada para instalaciones en uso interior. Ideal para comercios, iluminación técnica y decorativa.

Recommended for indoor installations. Ideal for shops, technical and decorative lighting.

Recommandé pour les installations intérieures. Idéal pour les magasins, l'éclairage technique et décoratif.

Importante instalar disipador de calor / Important to install heat sink / Important d'installer le dissipateur de chaleur.

Referencia Reference Référence	CCT(K)	Lumens/M	PVP/M
84047	RGB + CCT	Rojo 90 lm/m	24,95€
		Verde 360 lm/m	
		Azul 60 lm/m	
	3000k	480 lm/m	
	6000k	600 lm/m	

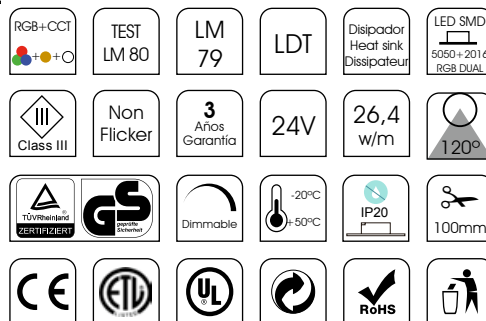

Características técnicas / Technical data / Caractéristiques techniques

Potencia rollo / Roll Power / Puissance de Roulis	528 W
CRI CRI	>90
Leds/m Leds/m	180 LED/M
Pitch Pitch	5,55 MM
SDCM SDCM	≤3
Corte min. / Min. Cutting Length / Min. coupure	100 M
Longitud rollo / Roll Length / Longueur du Rouleau	20 M
Vida útil / Life time / Durée de vie	75.000 H
Temperatura trabajo / Working temperature / Température de Fonctionnement	-20+50°C
Marca punto Tc / Tc Point mark / Marque de point Tc	Si / Yes / Oui
PCB PCB	3 oz
Longitud máx. / Max length. / Longueur max.	10 M

Perfiles / Profiles / Profilés

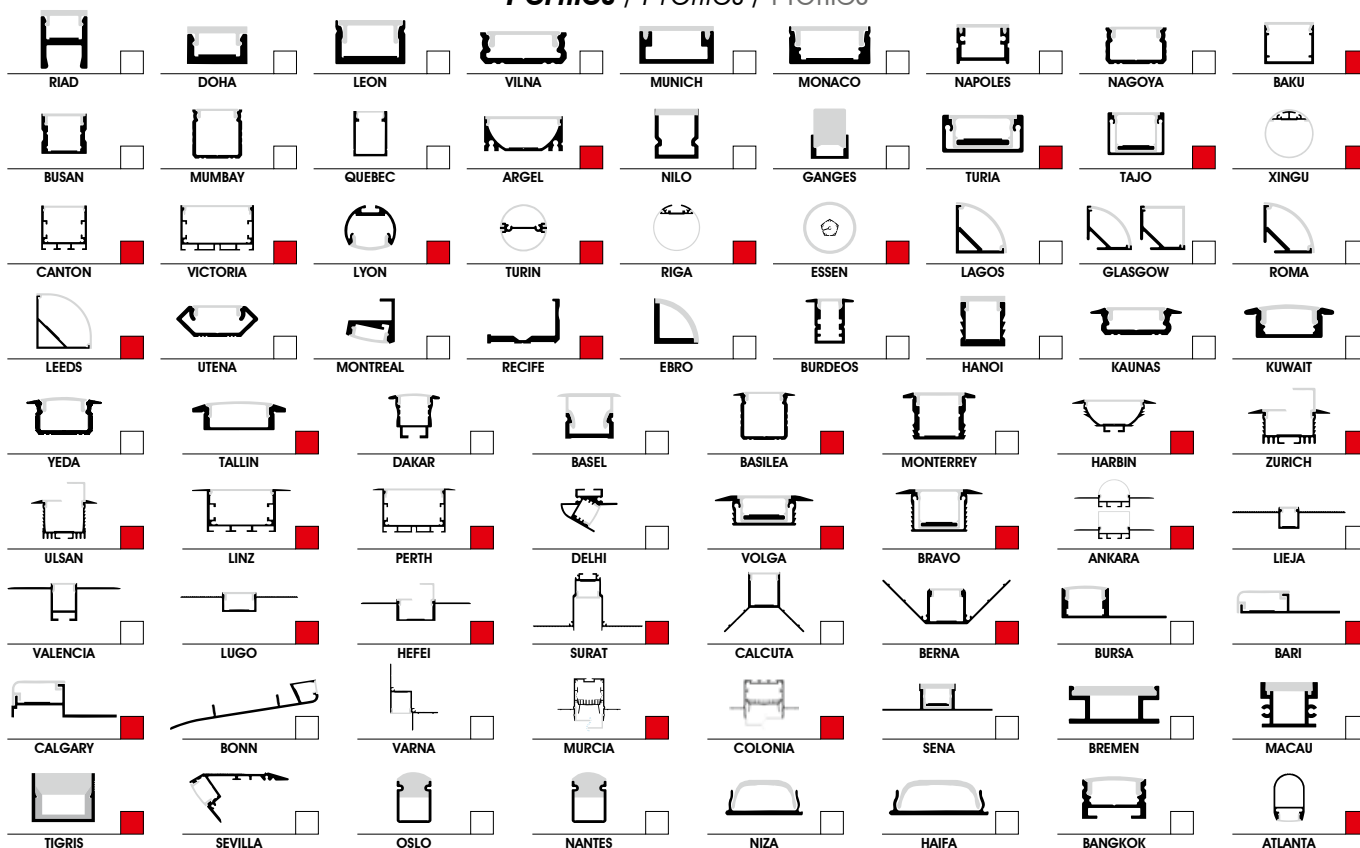

■ Perfil compatible con tira. / Strip compatible profile. / Profilé compatible bande. □ Perfil no compatible con tira. / Profile not compatible with strip. / Profilé non compatible avec la bande.

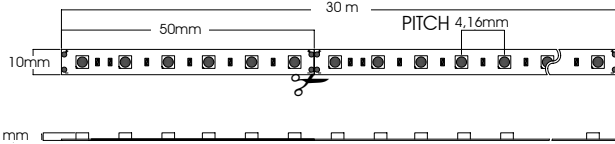

Aplicaciones: / Applications: / Applications:

Recomendada para instalaciones en uso interior. Ideal para comercios, iluminación técnica y decorativa.

Recommended for indoor installations. Ideal for shops, technical and decorative lighting.

Recommandé pour les installations intérieures. Idéal pour les magasins, l'éclairage technique et décoratif.

Importante instalar disipador de calor / Important to install heat sink / Important d'installer le dissipateur de chaleur.

Referencia Reference Référence	CCT(K)	Lumens/M	PVP/M
84044	○+● 1800-6500k DIMMABLE	2160 lm/m	19,95€

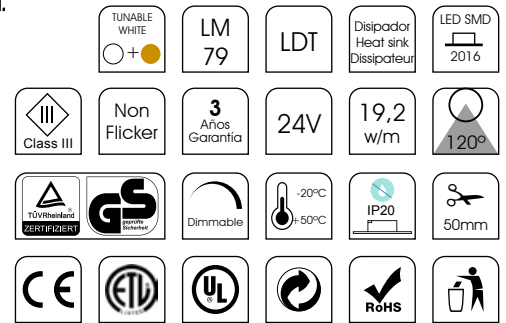

Características técnicas / Technical data / Caractéristiques techniques

Potencia rollo / Roll Power / Puissance de Roulis	576 W
CRI CRI	>90
Leds/m Leds/m	240 LED/M
Pitch Pitch	4,16 MM
SDCM SDCM	≤3
Corte min. / Min. Cutting Length / Min. coupure	50 MM
Longitud rollo / Roll Length / Longueur du Rouleau	30 M
Vida útil / Life time / Durée de vie	75.000 H
Temperatura trabajo / Working temperature / Température de Fonctionnement	-20+50°C
Marca punto Tc / Tc Point mark / Marque de point Tc	Si / Yes / Oui
PCB PCB	3 oz
Longitud máx. / Max length. / Longueur max.	10 M

1800 to 6500K



Perfiles / Profiles / Profilés

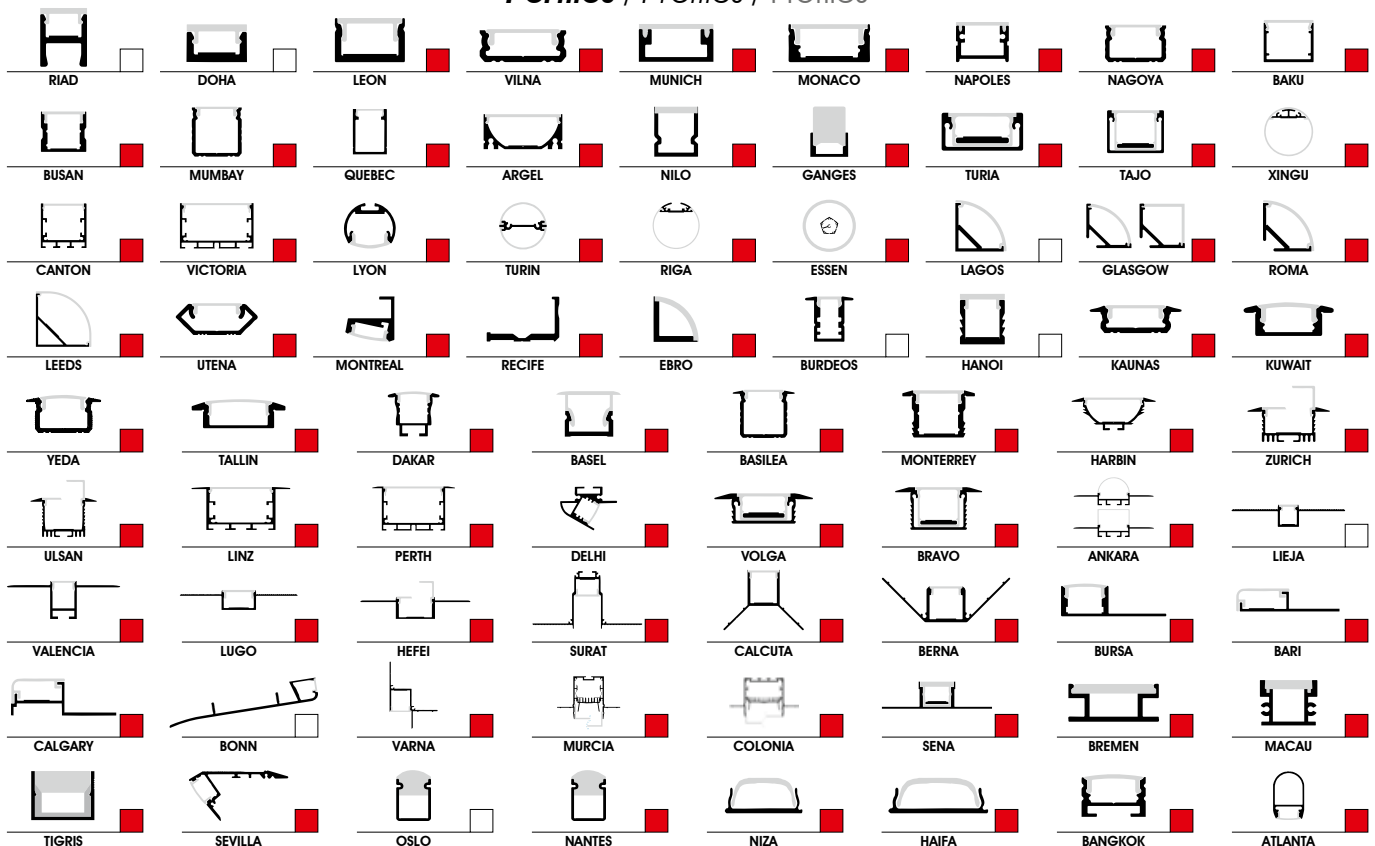

■ Perfil compatible con tira. / Strip compatible profile. / Profilé compatible bande. □ Perfil no compatible con tira. / Profile not compatible with strip. / Profilé non compatible avec la bande.

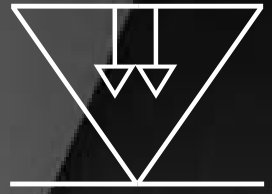

LYOPRO

LED PROFILE

Tira Flexible
Flexible Strip
Bande Flexi

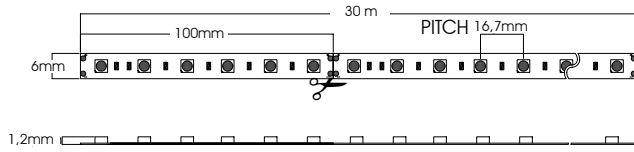

Aplicaciones: / Applications: / Applications:

Recomendada para instalaciones en uso interior. Ideal para comercios, iluminación técnica y decorativa.

Recommended for indoor installations. Ideal for shops, technical and decorative lighting.

Recommandé pour les installations intérieures. Idéal pour les magasins, l'éclairage technique et décoratif.

Importante instalar disipador de calor / Important to install heat sink / Important d'installer le dissipateur de chaleur.

Referencia Reference	CCT(K)	Lumens/M	Lumens/W	PVP/M
84074	2700k	1296 lm/m	90 lm/W	13,95€
84075	3000k	1368 lm/m	95 lm/W	
84076	4000k	1440 lm/m	100 lm/W	

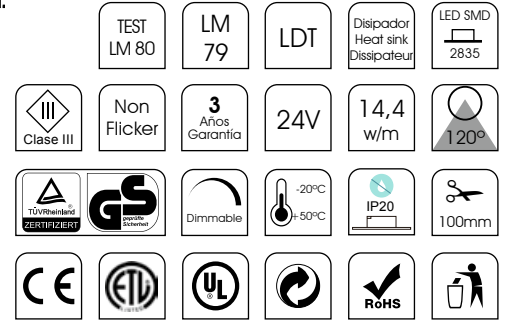

Características técnicas / Technical data / Caractéristiques techniques

Potencia rollo / Roll Power / Puissance de Roulis	432 W
CRI CRI	>80
Leds/m Leds/m	60 LED/M
Pitch Pitch	16,7 MM
SDCM SDCM	≤3
Corte min. / Min. Cutting Length / Min. coupure	100 MM
Longitud rollo / Roll Length / Longueur du Rouleau	30 M
Vida útil / Life time / Durée de vie	75.000 H
Temperatura trabajo / Working temperature / Température de Fonctionnement	-20+50°C
Marca punto Tc / Tc Point mark / Marque de point Tc	Si / Yes / Oui
PCB PCB	3 oz
Longitud máx. / Max length. / Longueur max.	10 M



Perfiles / Profiles / Profilés

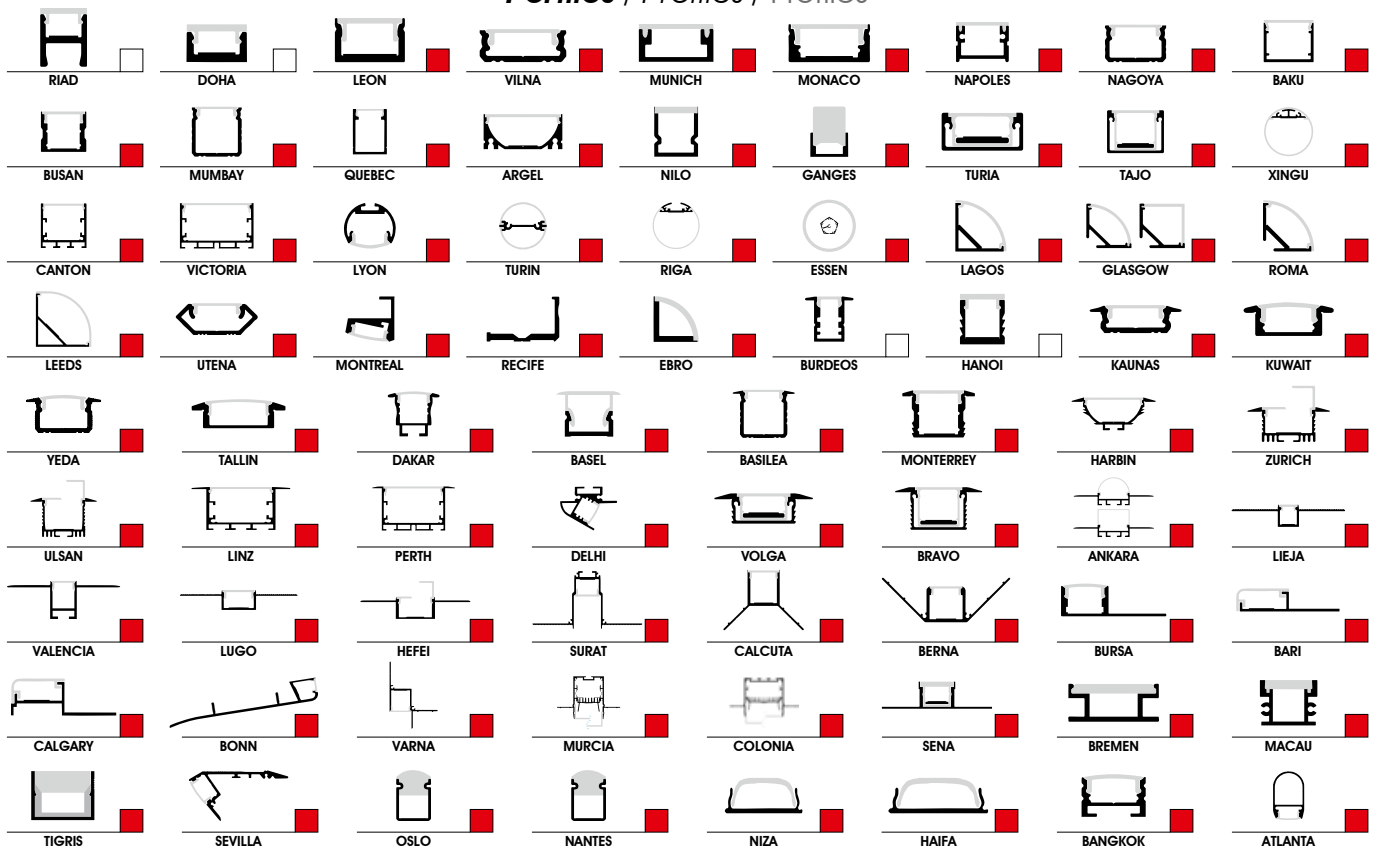

■ Perfil compatible con tira. / Strip compatible profile. / Profilé compatible bande. □ Perfil no compatible con tira. / Profile not compatible with strip. / Profilé non compatible avec la bande.

Tecnología LED lineal flexible, para iluminación de uso interior o exterior a nivel profesional con una elevada protección contra agentes externos y humedades, donde se presentan distintas opciones en potencias, temperaturas de color, reproducción cromática y siempre con altas prestaciones en eficiencia energética.

Flexible linear LED technology, for lighting for indoor or outdoor use at a professional level with high protection against external agents and humidities, where different options are presented in powers, color temperatures, color reproduction and always with high performance in energy efficiency.

Technologie LED linéaire flexible, pour un éclairage à usage intérieur ou extérieur de niveau professionnel avec une protection élevée contre les agents extérieurs et humidités, où différentes options sont présentées dans les puissances, les températures de couleur, la reproduction des couleurs et toujours avec des performances élevées en matière d'efficacité énergétique.



LYOPRO

LED PROFILE



Waterproof Series

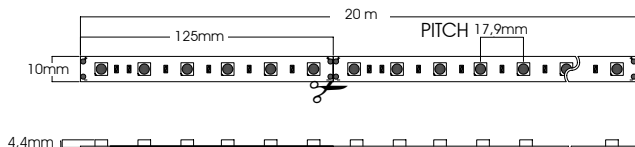

Aplicaciones: / Applications: / Applications:

Recomendada para instalaciones en uso interior y exterior. Ideal para comercios, iluminación técnica y decorativa.
Recommended for indoor and outdoor installations. Ideal for shops, technical and decorative lighting.
Recommandé pour les installations intérieures et extérieures. Idéal pour les magasins, l'éclairage technique et décoratif.

Importante instalar disipador de calor / Important to install heat sink / Important d'installer le dissipateur de chaleur.

Referencia Reference Référence	CCT(K)	Lumens/M	Lumens/W	PVP/M
86028	2700k	780 lm/m	130 lm/W	13,85€
80029	3000k	800 lm/m	133 lm/W	
80030	4000k	820 lm/m	136 lm/W	
80031	6000k	840 lm/m	140 lm/W	

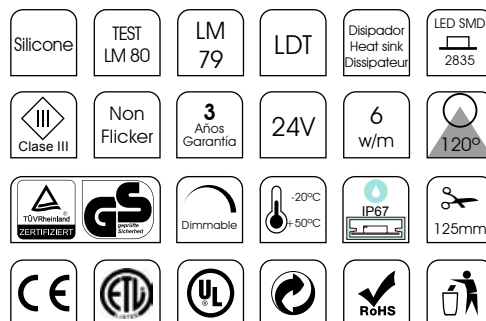

Características técnicas / Technical data / Caractéristiques techniques

Potencia rollo / Roll Power / Puissance de Roulis	120 W
CRI CRI	>80
Leds/m Leds/m	56 LED/M
Pitch Pitch	17,9 MM
SDCM SDCM	≤3
Corte min. / Min. Cutting Length / Min. coupure	125 MM
Longitud rollo / Roll Length / Longueur du Rouleau	20 M
Vida útil / Life time / Durée de vie	75.000 H
Temperatura trabajo / Working temperature / Température de Fonctionnement	-20+50°C
Marca punto Tc / Tc Point mark / Marque de point Tc	Si / Yes / Oui
PCB PCB	3 oz
Longitud máx. / Max length. / Longueur max.	10 M

Perfiles / Profiles / Profilés

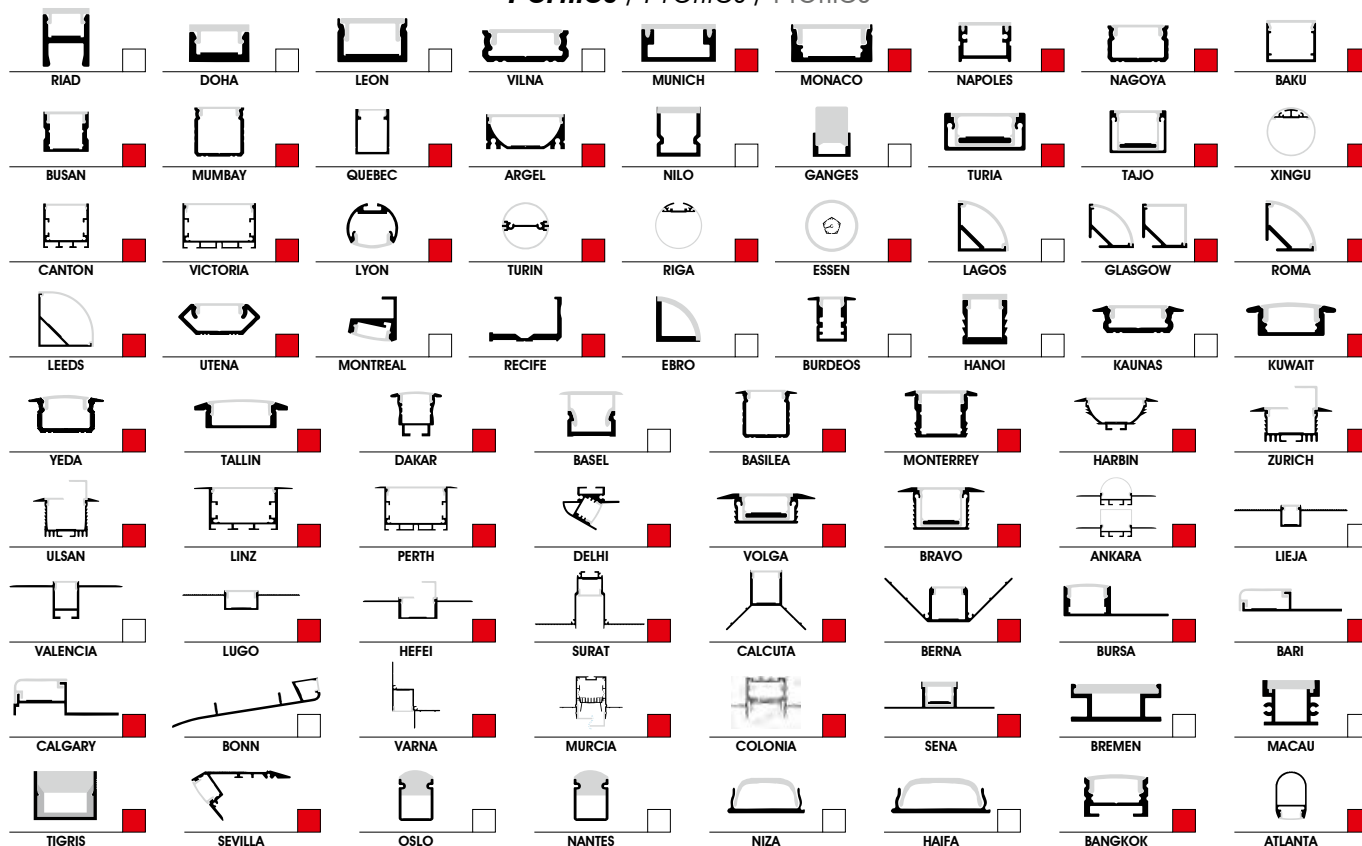

■ Perfil compatible con tira. / Strip compatible profile. / Profilé compatible bande. □ Perfil no compatible con tira. / Profile not compatible with strip. / Profilé non compatible avec la bande.

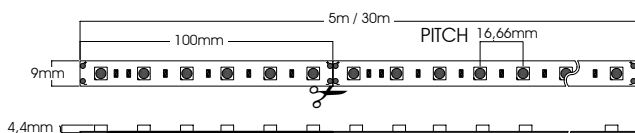

Aplicaciones: / Applications: / Applications:

Recomendada para instalaciones en uso interior y exterior. Ideal para comercios, iluminación técnica y decorativa.

Recommended for indoor and outdoor installations. Ideal for shops, technical and decorative lighting.

Recommandé pour les installations intérieures et extérieures. Idéal pour les magasins, l'éclairage technique et décoratif.

Importante instalar disipador de calor / Important to install heat sink / Important d'installer le dissipateur de chaleur.

Referencia Reference Référence	CCT(K)	Lumens/M	Lumens/W	PVP
84360	2700k	864 lm/m	90 lm/W	8,95€ / M
84361	3000k	874 lm/m	91 lm/W	
84362	4000k	892 lm/m	93 lm/W	
84363	6000k	912 lm/m	95 lm/W	
84365	2700k	864 lm/m	90 lm/W	43,95€ / 5M
84366	3000k	874 lm/m	91 lm/W	
84367	4000k	892 lm/m	93 lm/W	
84368	6000k	912 lm/m	95 lm/W	

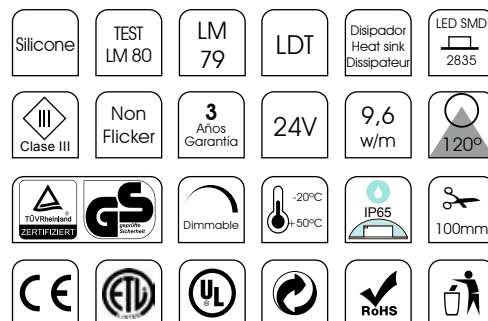

Características técnicas / Technical data / Caractéristiques techniques

Potencia rollo / Roll Power / Puissance de Roulis	48 W / 288 W
CRI CRI	>80
Leds/m Leds/m	60 LED/M
Pitch Pitch	16,66 MM
SDCM SDCM	≤3
Corte min. / Min. Cutting Length / Min. coupure	100 MM
Longitud rollo / Roll Length / Longueur du Rouleau	5 M / 30 M
Vida útil / Life time / Durée de vie	75.000 H
Temperatura trabajo / Working temperature / Température de Fonctionnement	-20+50°C
Marca punto Tc / Tc Point mark / Marque de point Tc	Si / Yes / Oui
PCB PCB	3 oz
Longitud máx. / Max length. / Longueur max.	10 M

Perfiles / Profiles / Profilés

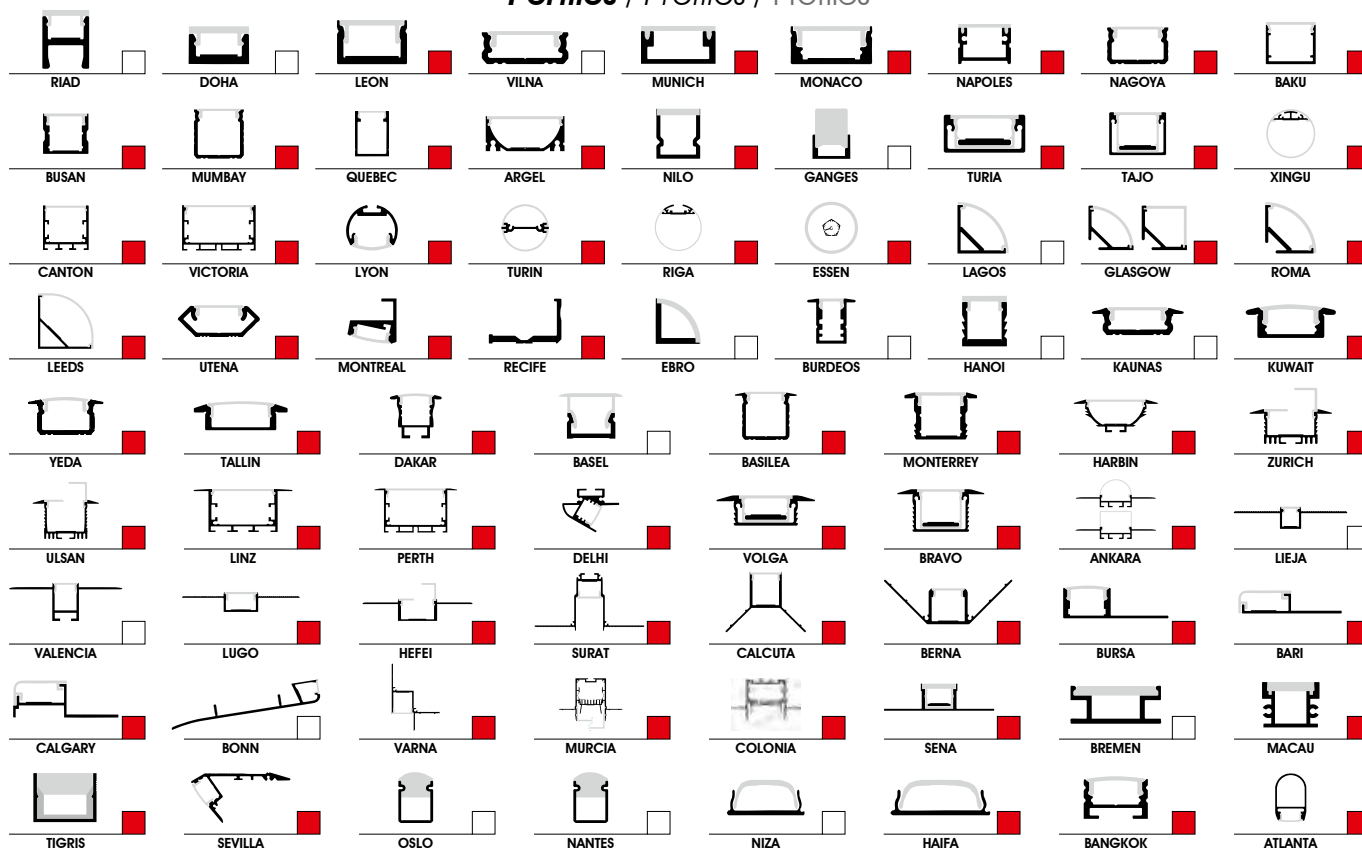

■ Perfil compatible con tira. / Strip compatible profile. / Profilé compatible bande. □ Perfil no compatible con tira. / Profile not compatible with strip. / Profilé non compatible avec la bande.

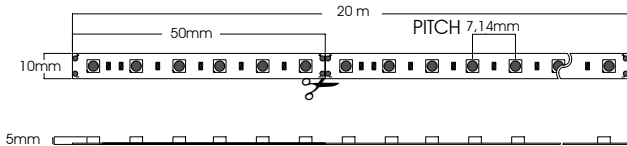

Aplicaciones: / Applications: / Applications:

Recomendada para instalaciones en uso interior y exterior. Ideal para comercios, iluminación técnica y decorativa.
Recommended for indoor and outdoor installations. Ideal for shops, technical and decorative lighting.
Recommandé pour les installations intérieures et extérieures. Idéal pour les magasins, l'éclairage technique et décoratif.

Importante instalar disipador de calor / Important to install heat sink / Important d'installer le dissipateur de chaleur.

Referencia Reference Référence	CCT(K)	Lumens/M	Lumens/W	PVP/M
86003	2700k	1258 lm/m	131 lm/W	16,25€
84004	3000k	1277 lm/m	133 lm/W	
84005	4000k	1296 lm/m	135 lm/W	
84006	6000k	1344 lm/m	140 lm/W	

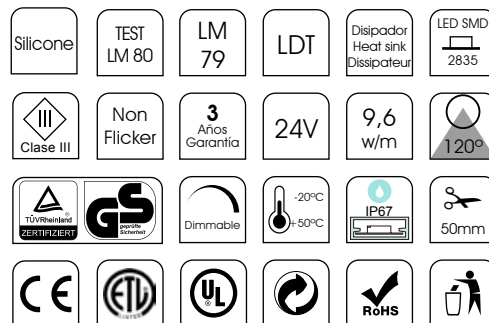

Características técnicas / Technical data / Caractéristiques techniques

Potencia rollo / Roll Power / Puissance de Roulis	192 W
CRI CRI	>80
Leds/m Leds/m	140 LED/M
Pitch Pitch	7,14 MM
SDCM SDCM	≤3
Corte min. / Min. Cutting Length / Min. coupure	50 MM
Longitud rollo / Roll Length / Longueur du Rouleau	20 M
Vida útil / Life time / Durée de vie	75.000 H
Temperatura trabajo / Working temperature / Température de Fonctionnement	-20+50°C
Marca punto Tc / Tc Point mark / Marque de point Tc	Si / Yes / Oui
PCB PCB	3 oz
Longitud máx. / Max length. / Longueur max.	10 M

Perfiles / Profiles / Profilés

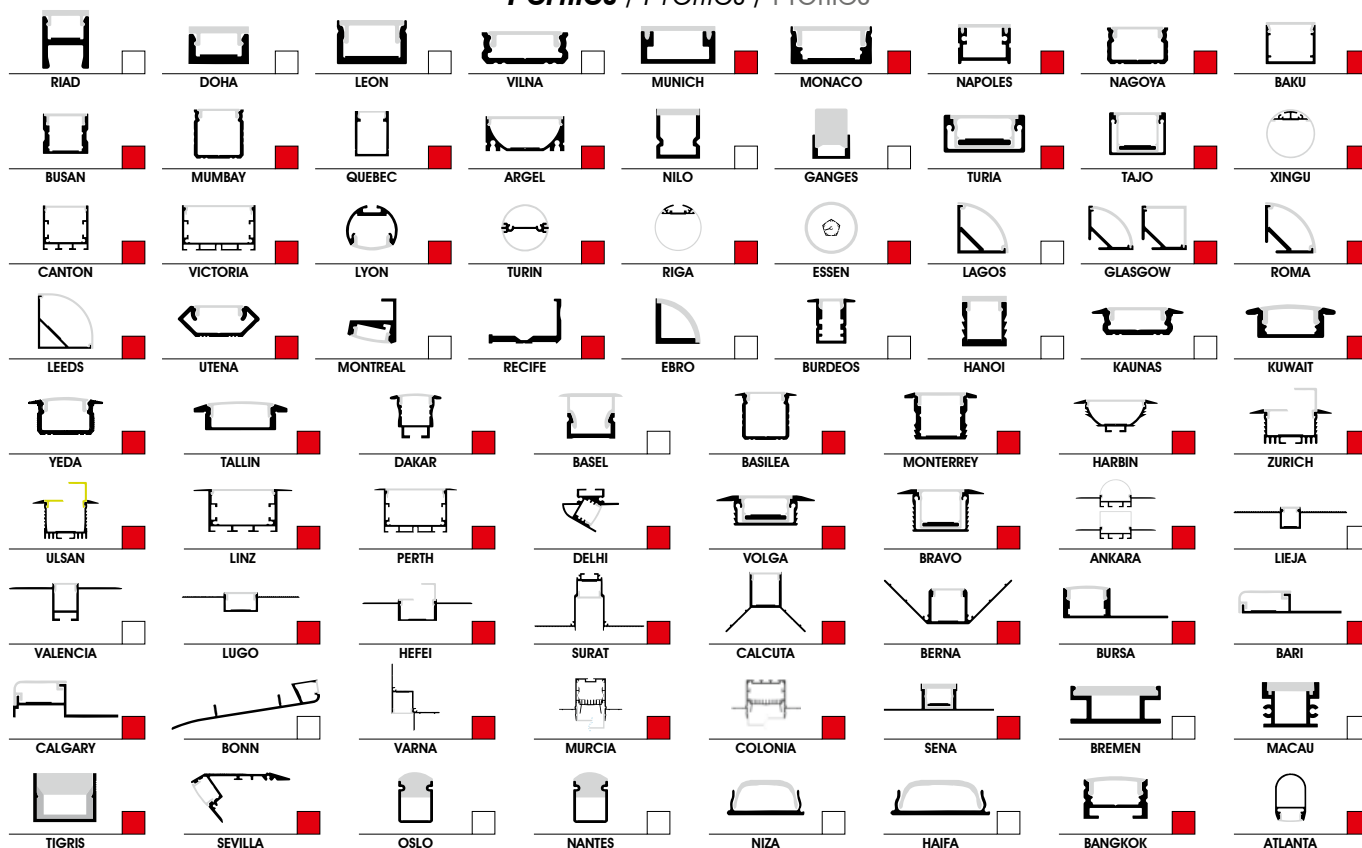

■ Perfil compatible con tira. / Strip compatible profile. / Profilé compatible bande. □ Perfil no compatible con tira. / Profile not compatible with strip. / Profilé non compatible avec la bande.

OREGÓN 12w/m · IP67 · 24v · Cri>80

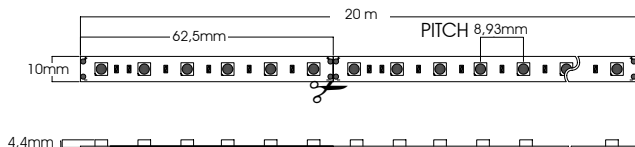

Aplicaciones: / Applications: / Applications:

Recomendada para instalaciones en uso interior y exterior. Ideal para comercios, iluminación técnica y decorativa.
Recommended for indoor and outdoor installations. Ideal for shops, technical and decorative lighting.
Recommandé pour les installations intérieures et extérieures. Idéal pour les magasins, l'éclairage technique et décoratif.

Importante instalar disipador de calor / Important to install heat sink / Important d'installer le dissipateur de chaleur.

Referencia Reference Référence	CCT(K)	Lumens/M	Lumens/W	PVP/M
86034	2700k	1560 lm/m	130 lm/W	17,25€
80035	3000k	1600 lm/m	133 lm/W	
80036	4000k	1640 lm/m	136 lm/W	
80037	6000k	1680 lm/m	140 lm/W	

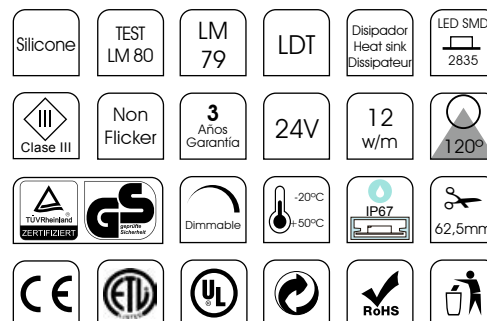

Características técnicas / Technical data / Caractéristiques techniques

Potencia rollo / Roll Power / Puissance de Roulis	240 W
CRI CRI	>80
Leds/m Leds/m	112 LED/M
Pitch Pitch	8.93 MM
SDCM SDCM	≤3
Corte min. / Min. Cutting Length / Min. coupure	62,5 MM
Longitud rollo / Roll Length / Longueur du Rouleau	20 M
Vida útil / Life time / Durée de vie	75.000 H
Temperatura trabajo / Working temperature / Température de Fonctionnement	-20+50°C
Marca punto Tc / Tc Point mark / Marque de point Tc	Si / Yes / Oui
PCB PCB	3 oz
Longitud máx. / Max length. / Longueur max.	10 M

Perfiles / Profiles / Profilés

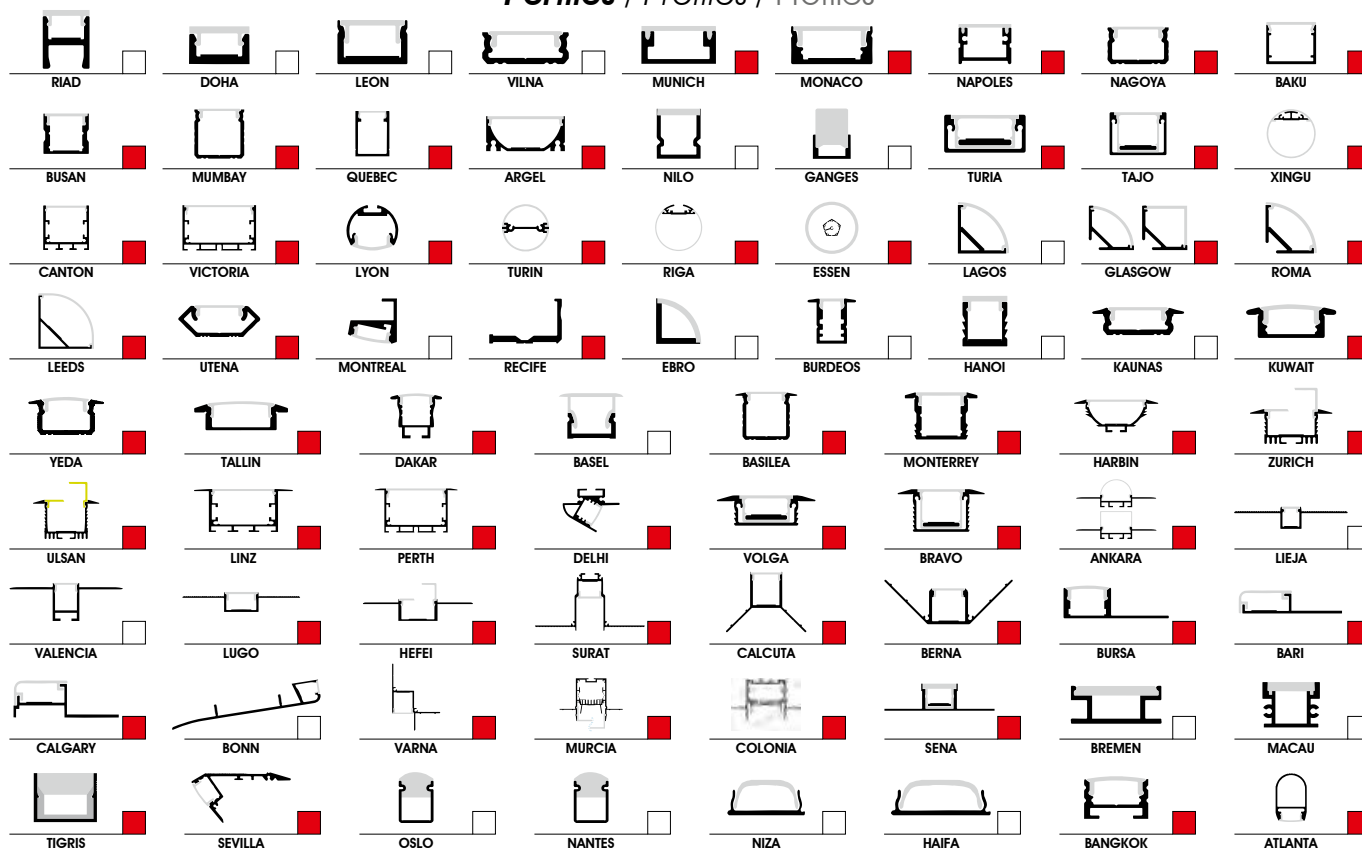

■ Perfil compatible con tira. / Strip compatible profile. / Profilé compatible bande. □ Perfil no compatible con tira. / Profile not compatible with strip. / Profilé non compatible avec la bande.

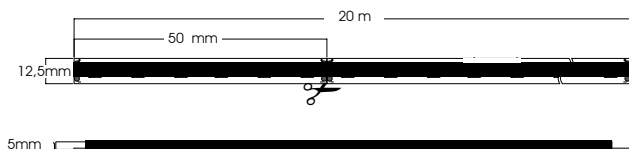

Aplicaciones: / Applications: / Applications:

Recomendada para instalaciones en uso interior y exterior. Ideal para comercios, iluminación técnica y decorativa.
 Recommended for indoor and outdoor installations. Ideal for shops, technical and decorative lighting.
 Recommandé pour les installations intérieures et extérieures. Idéal pour les magasins, l'éclairage technique et décoratif.

Importante Instalar disipador de calor / Important to install heat sink / Important d'installer le dissipateur de chaleur.

Silicone	TEST LM 80	LM 79	LDT	Disipador Heat sink Dissipateur	LED COB
Class III	Non Flicker	3 Años Garantía	24V	12 w/m	140°
TUV Rheinland CERTIFIED	GS	Dimmable	-20°C +50°C	IP67	50mm
CE	ETL	UL	Recycling	RoHS	Waste

Referencia Reference Référence	CCT(K)	Lumens/M	Lumens/W	PVP/M
84088	2700k	1050 lm/m	88 lm/W	19,95€
84089	3000k	1120 lm/m	93 lm/W	
84090	4000k	1200 lm/m	100 lm/W	
84091	6000k	1280 lm/m	106 lm/W	

Características técnicas / Technical data / Caractéristiques techniques

Potencia rollo / Roll Power / Puissance de Roulis	240 W
CRI CRI	>90
Leds/m Leds/m	480 LED/M
Pitch Pitch	Led continuo / Continuous led / Led continue
SDCM SDCM	≤3
Corte min. / Min. Cutting Length / Min. coupure	50 MM
Longitud rollo / Roll Length / Longueur du Rouleau	20 M
Vida útil / Life time / Durée de vie	75.000 H
Temperatura trabajo / Working temperature / Température de Fonctionnement	-20+50°C
Marca punto Tc / Tc Point mark / Marque de point Tc	Si / Yes / Oui
PCB PCB	3 oz
Longitud máx. / Max length. / Longueur max.	10 M

Perfiles / Profiles / Profilés

RIAD	DOHA	LEON	VILNA	MUNICH	MONACO	NAPOLIS	NAGOYA	BAKU
BUSAN	MUMBAI	QUEBEC	ARGEL	NILO	GANGES	TURIA	TAJO	XINGU
CANTON	VICTORIA	LYON	TURIN	RIGA	ESSEN	LAGOS	GLASGOW	ROMA
LEEDS	UTENA	MONTREAL	RECIFE	EBRO	BURDEOS	HANOI	KAUNAS	KUWAIT
YEDA	TALLIN	DAKAR	BASEL	BASILEA	MONTERREY	HARBIN	ZURICH	
ULSAN	LINZ	PERTH	DELHI	VOLGA	BRAVO	ANKARA	LIEJA	
VALENCIA	LUGO	HEFEI	SURAT	CALCUTA	BERNA	BURSA	BARI	
CALGARY	BONN	VARNA	MURCIA	COLONIA	SENA	BREMEN	MACAU	
TIGRIS	SEVILLA	OSLO	NANTES	NIZA	HAIFA	BANGKOK	ATLANTA	

■ Perfil compatible con tira. / Strip compatible profile. / Profilé compatible bande. □ Perfil no compatible con tira. / Profile not compatible with strip. / Profilé non compatible avec la bande.

MISURI 14,4w/m · IP65 · 24v · Cri>80

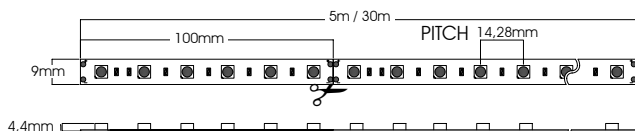

Aplicaciones: / Applications: / Applications:

Recomendada para instalaciones en uso interior y exterior. Ideal para comercios, iluminación técnica y decorativa.

Recommended for indoor and outdoor installations. Ideal for shops, technical and decorative lighting.

Recommandé pour les installations intérieures et extérieures. Idéal pour les magasins, l'éclairage technique et décoratif.

Importante instalar disipador de calor / Important to install heat sink / Important d'installer le dissipateur de chaleur.

Referencia Reference Référence	CCT(K)	Lumens/M	Lumens/W	PVP
84420	2700k	1325 lm/m	92 lm/W	9,75€ / M
84421	3000k	1354 lm/m	94 lm/W	
84422	4000k	1397 lm/m	97 lm/W	
84423	6000k	1440 lm/m	100 lm/W	
84425	2700k	1325 lm/m	92 lm/W	45,95€ / 5M
84426	3000k	1354 lm/m	94 lm/W	
84427	4000k	1397 lm/m	97 lm/W	
84428	6000k	1440 lm/m	100 lm/W	

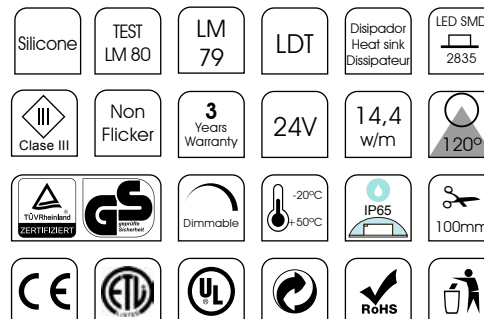

Características técnicas / Technical data / Caractéristiques techniques

Potencia rollo / Roll Power / Puissance de Roulis	72 W / 432 W
CRI / CRI	>80
Leds/m Leds/m	70 LED/M
Pitch / Pitch	14,28 MM
SDCM / SDCM	≤3
Corte min. / Min. Cutting Length / Min. coupure	100 MM
Longitud rollo / Roll Length / Longueur du Rouleau	5 M / 30 M
Vida útil / Life time / Durée de vie	75.000 H
Temperatura trabajo / Working temperature / Température de Fonctionnement	-20+50°C
Marca punto Tc / Tc Point mark / Marque de point Tc	Si / Yes / Oui
PCB / PCB	3 oz
Longitud máx. / Max length. / Longueur max.	10 M

Perfiles / Profiles / Profilés

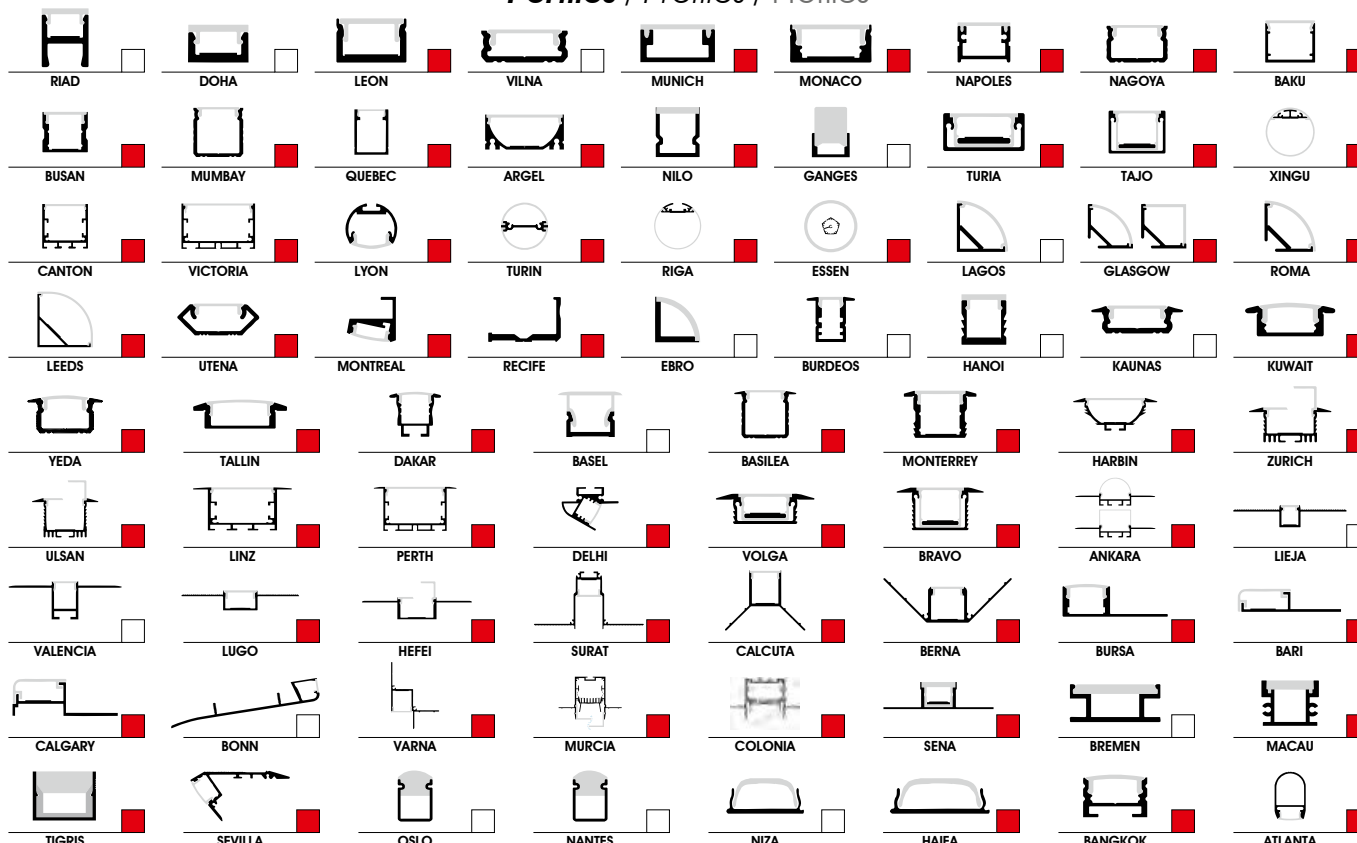

Perfil compatible con tira. / Strip compatible profile. / Profilé compatible bande. Perfil no compatible con tira. / Profile not compatible with strip. / Profilé non compatible avec la bande.

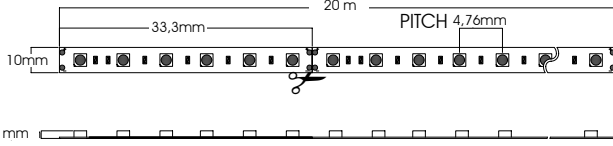

Aplicaciones: / Applications: / Applications:

Recomendada para instalaciones en uso interior y exterior. Ideal para comercios, iluminación técnica y decorativa.
 Recommended for indoor and outdoor installations. Ideal for shops, technical and decorative lighting.
 Recommandé pour les installations intérieures et extérieures. Idéal pour les magasins, l'éclairage technique et décoratif.

Importante Instalar disipador de calor / Important to install heat sink / Important d'installer le dissipateur de chaleur.

Referencia Reference Référence	CCT(K)	Lumens/M	Lumens/W	PVP/M
86010	2700k	1886 lm/m	131 lm/W	19,95€
84011	3000k	1915 lm/m	133 lm/W	
84012	4000k	1956 lm/m	136 lm/W	
84013	6000k	2016 lm/m	140 lm/W	

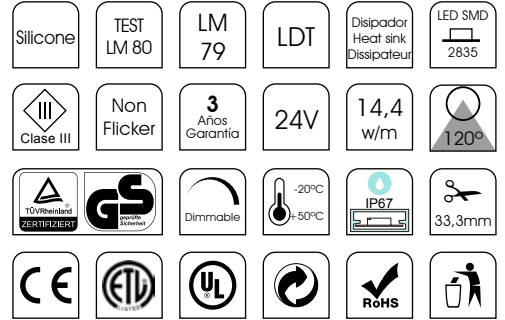

Características técnicas / Technical data / Caractéristiques techniques

Potencia rollo / Roll Power / Puissance de Roulis	288 W
CRI CRI	>80
Leds/m Leds/m	210 LED/M
Pitch Pitch	4,76 MM
SDCM SDCM	≤3
Corte min. / Min. Cutting Length / Min. coupure	33,3 MM
Longitud rollo / Roll Length / Longueur du Rouleau	20 M
Vida útil / Life time / Durée de vie	75.000 H
Temperatura trabajo / Working temperature / Température de Fonctionnement	-20+50°C
Marca punto Tc / Tc Point mark / Marque de point Tc	Si / Yes / Oui
PCB PCB	3 oz
Longitud máx. / Max length. / Longueur max.	10 M

Perfiles / Profiles / Profilés

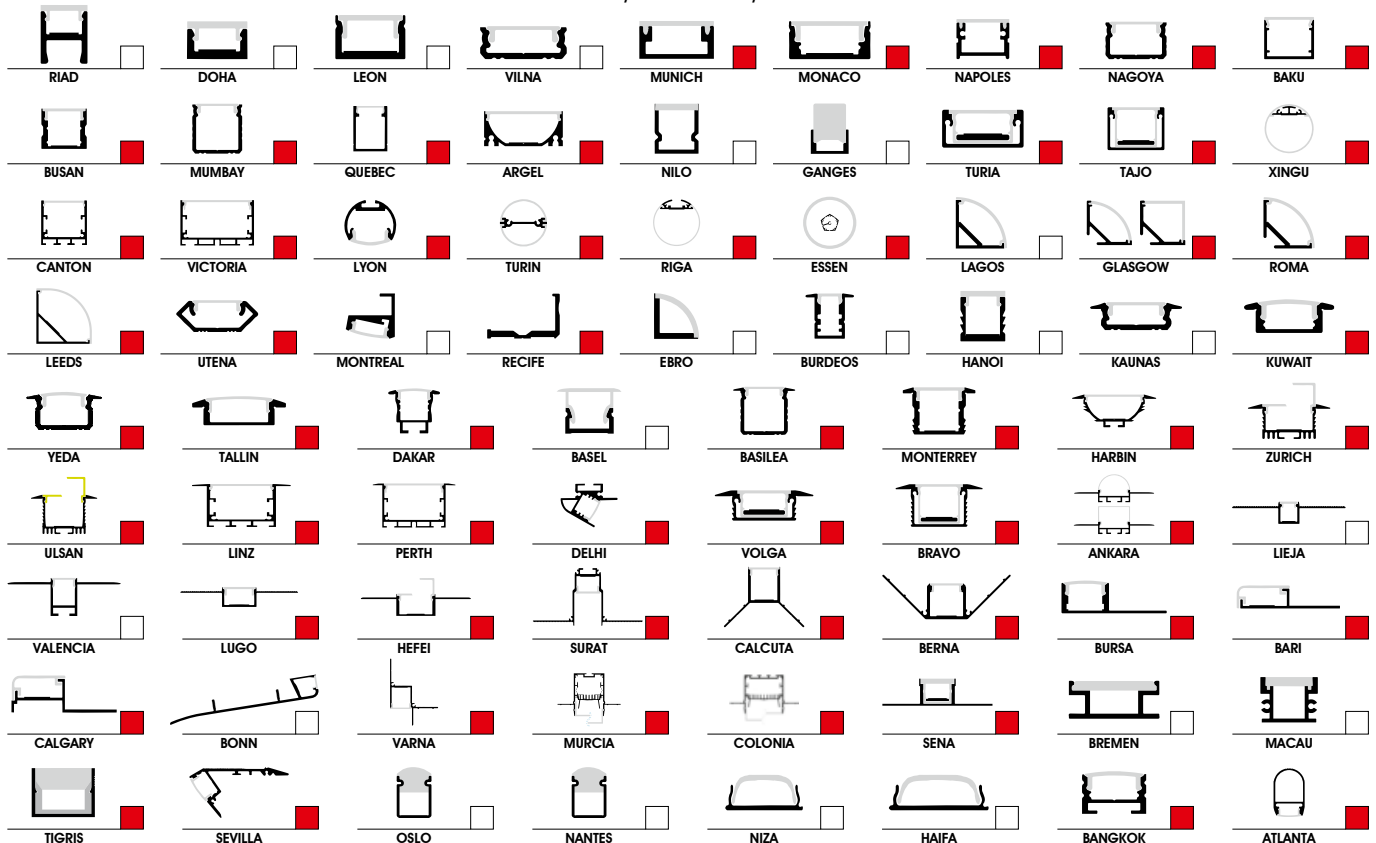

■ Perfil compatible con tira. / Strip compatible profile. / Profilé compatible bande. □ Perfil no compatible con tira. / Profile not compatible with strip. / Profilé non compatible avec la bande.

ARIZONA 17w/m · IP67 · 24v · Cri>80

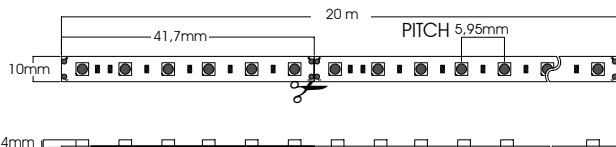

Aplicaciones: / Applications: / Applications:

Recomendada para instalaciones en uso interior y exterior. Ideal para comercios, iluminación técnica y decorativa.
Recommended for indoor and outdoor installations. Ideal for shops, technical and decorative lighting.
Recommandé pour les installations intérieures et extérieures. Idéal pour les magasins, l'éclairage technique et décoratif.

Importante instalar disipador de calor / Important to install heat sink / Important d'installer le dissipateur de chaleur.

Referencia Reference Référence	CCT(K)	Lumens/M	Lumens/W	PVP/M
86040	2700k	2210 lm/m	130 lm/W	20,95€
80041	3000k	2270 lm/m	133 lm/W	
80042	4000k	2320 lm/m	136 lm/W	
80043	6000k	2380 lm/m	140 lm/W	



Características técnicas / Technical data / Caractéristiques techniques

Potencia rollo / Roll Power / Puissance de Roulis	340 W
CRI CRI	>80
Leds/m Leds/m	168 LED/M
Pitch Pitch	5,95 MM
SDCM SDCM	≤3
Corte min. / Min. Cutting Length / Min. coupure	41,7 MM
Longitud rollo / Roll Length / Longueur du Rouleau	20 M
Vida útil / Life time / Durée de vie	75.000 H
Temperatura trabajo / Working temperature / Température de Fonctionnement	-20 +50°C
Marca punto Tc / Tc Point mark / Marque de point Tc	Si / Yes / Oui
PCB PCB	3 oz
Longitud máx. / Max length. / Longueur max.	10 M

Perfiles / Profiles / Profilés

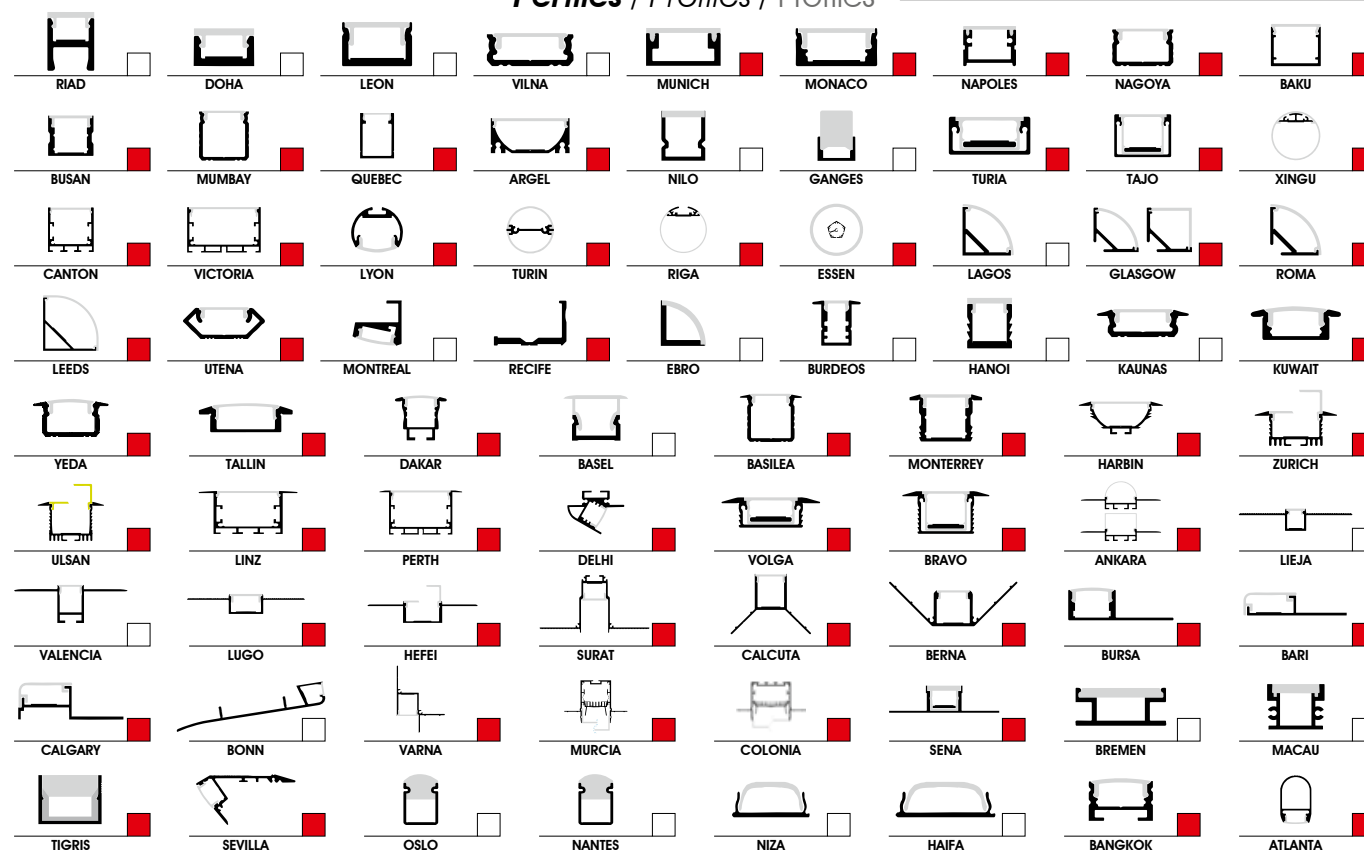

■ Perfil compatible con tira. / Strip compatible profile. / Profilé compatible bande. □ Perfil no compatible con tira. / Profile not compatible with strip. / Profilé non compatible avec la bande.

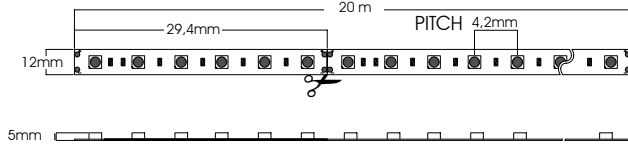

Aplicaciones: / Applications: / Applications:

Recomendada para instalaciones en uso interior y exterior. Ideal para comercios, iluminación técnica y decorativa.
 Recommended for indoor and outdoor installations. Ideal for shops, technical and decorative lighting.
 Recommandé pour les installations intérieures et extérieures. Idéal pour les magasins, l'éclairage technique et décoratif.

Importante instalar disipador de calor / Important to install heat sink / Important d'installer le dissipateur de chaleur.

Referencia Reference Référence	CCT(K)	Lumens/M	Lumens/W	PVP/M
86017	2700k	2515 lm/m	131 lm/W	22,95€
84018	3000k	2553 lm/m	133 lm/W	
84019	4000k	2592 lm/m	135 lm/W	
84020	6000k	2688 lm/m	140 lm/W	



Características técnicas / Technical data / Caractéristiques techniques

Potencia rollo / Roll Power / Puissance de Roulis	384 W
CRI CRI	>80
Leds/m Leds/m	238 LED/M
Pitch Pitch	4,2 MM
SDCM SDCM	≤3
Corte min. / Min. Cutting Length / Min. coupure	29,4 MM
Longitud rollo / Roll Length / Longueur du Rouleau	20 M
Vida útil / Life time / Durée de vie	75.000 H
Temperatura trabajo / Working temperature / Température de Fonctionnement	-20+50°C
Marca punto Tc / Tc Point mark / Marque de point Tc	Si / Yes / Oui
PCB PCB	3 oz
Longitud máx. / Max length. / Longueur max.	10 M

Perfiles / Profiles / Profilés

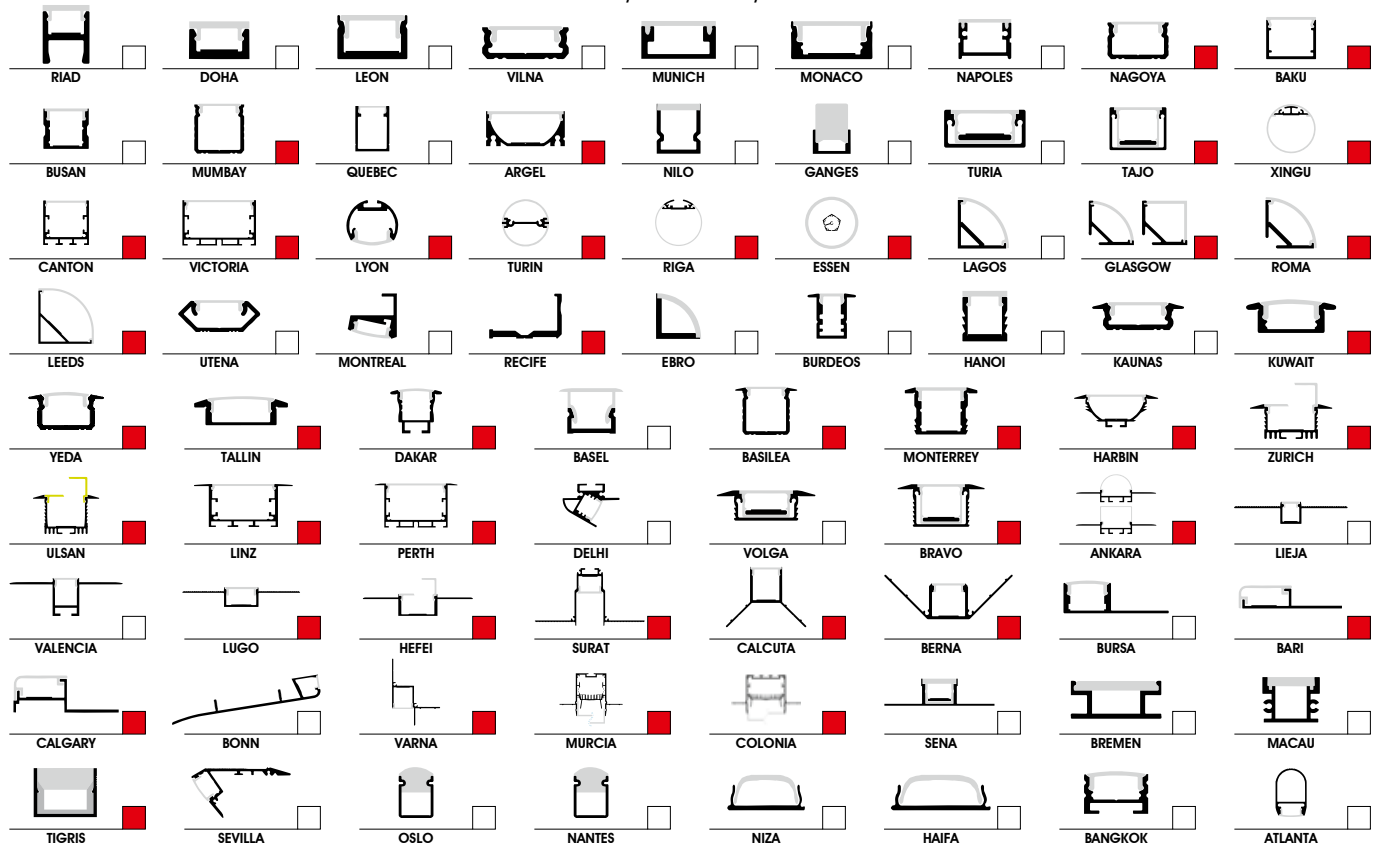

■ Perfil compatible con tira. / Strip compatible profile. / Profilé compatible bande. □ Perfil no compatible con tira. / Profile not compatible with strip. / Profilé non compatible avec la bande.

DETROIT 24w/m · IP67 · 24v · Cri>80

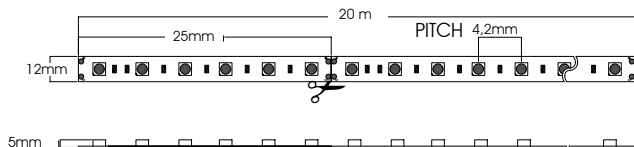

Aplicaciones: / Applications: / Applications:

Recomendada para instalaciones en uso interior y exterior. Ideal para comercios, iluminación técnica y decorativa.
Recommended for indoor and outdoor installations. Ideal for shops, technical and decorative lighting.
Recommandé pour les installations intérieures et extérieures. Idéal pour les magasins, l'éclairage technique et décoratif.

Importante instalar disipador de calor / Important to install heat sink / Important d'installer le dissipateur de chaleur.

Referencia Reference Référence	CCT(K)	Lumens/M	Lumens/W	PVP/M
86024	2700k	2640 lm/m	110 lm/W	24,95€
84025	3000k	2688 lm/m	112 lm/W	
84026	4000k	2760 lm/m	115 lm/W	
84027	6000k	2880 lm/m	120 lm/W	

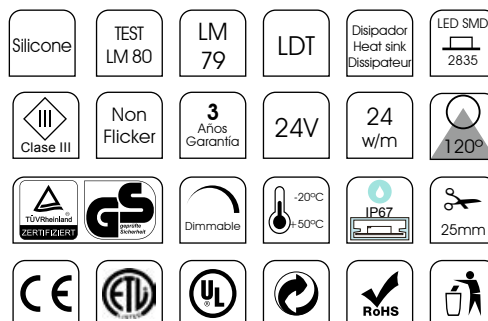

Características técnicas / Technical data / Caractéristiques techniques

Potencia rollo / Roll Power / Puissance de Roulis	480 W
CRI CRI	>80
Leds/m Leds/m	240 LED/M
Pitch Pitch	4,2 MM
SDCM SDCM	≤3
Corte min. / Min. Cutting Length / Min. coupure	25 MM
Longitud rollo / Roll Length / Longueur du Rouleau	20 M
Vida útil / Life time / Durée de vie	75.000 H
Temperatura trabajo / Working temperature / Température de Fonctionnement	-20+50°C
Marca punto Tc / Tc Point mark / Marque de point Tc	Si / Yes / Oui
PCB PCB	3 oz
Longitud máx. / Max length. / Longueur max.	10 M

Perfiles / Profiles / Profilés

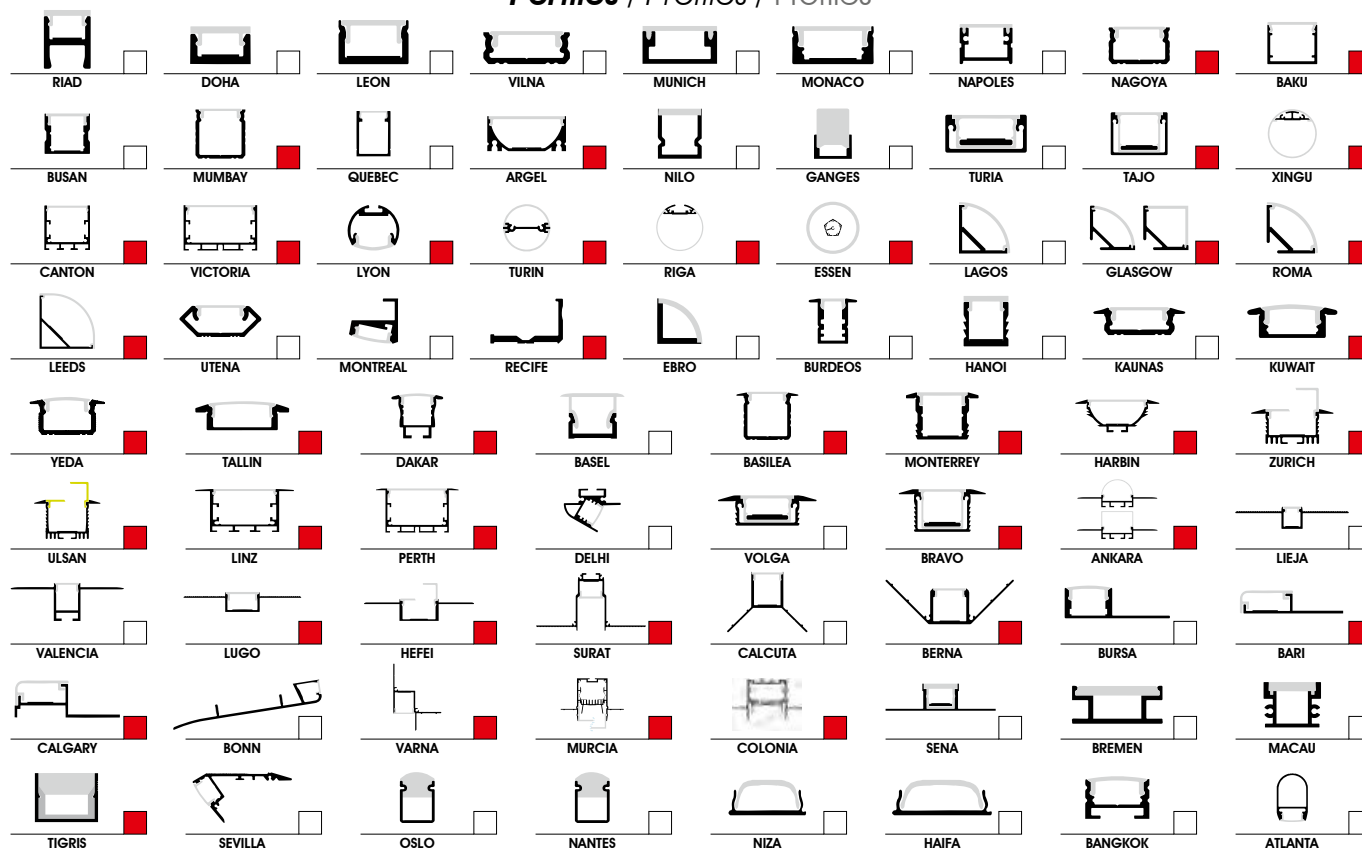

■ Perfil compatible con tira. / Strip compatible profile. / Profilé compatible bande. □ Perfil no compatible con tira. / Profile not compatible with strip. / Profilé non compatible avec la bande.

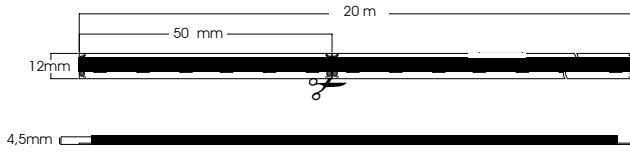

Aplicaciones: / Applications: / Applications:

Recomendada para instalaciones en uso interior y exterior. Ideal para comercios, iluminación técnica y decorativa.
 Recommended for indoor and outdoor installations. Ideal for shops, technical and decorative lighting.
 Recommandé pour les installations intérieures et extérieures. Idéal pour les magasins, l'éclairage technique et décoratif.

Importante instalar disipador de calor / Important to install heat sink / Important d'installer le dissipateur de chaleur.

Referencia Référence	CCT(K)	Lumens/M	PVP/M
86051	RGB (Multicolor)	495 lm/m	25,95€
		Rojo 100 lm/m	
		Verde 275 lm/m	
		Azul 85 lm/m	



Características técnicas / Technical data / Caractéristiques techniques

Potencia rollo / Roll Power / Puissance de Roulis	240 W
CRI CRI	>90
Leds/m Leds/m	840 LED/M
Pitch Pitch	Led continuo / Continuous led / Led continue
SDCM SDCM	≤3
Corte min. / Min. Cutting Length / Min. coupure	50 MM
Longitud rollo / Roll Length / Longueur du Rouleau	20 M
Vida útil / Life time / Durée de vie	75.000 H
Temperatura trabajo / Working temperature / Température de Fonctionnement	-20+50°C
Marca punto Tc / Tc Point mark / Marque de point Tc	Si / Yes / Oui
PCB PCB	3 oz
Longitud máx. / Max length. / Longueur max.	10 M

Perfiles / Profiles / Profilés

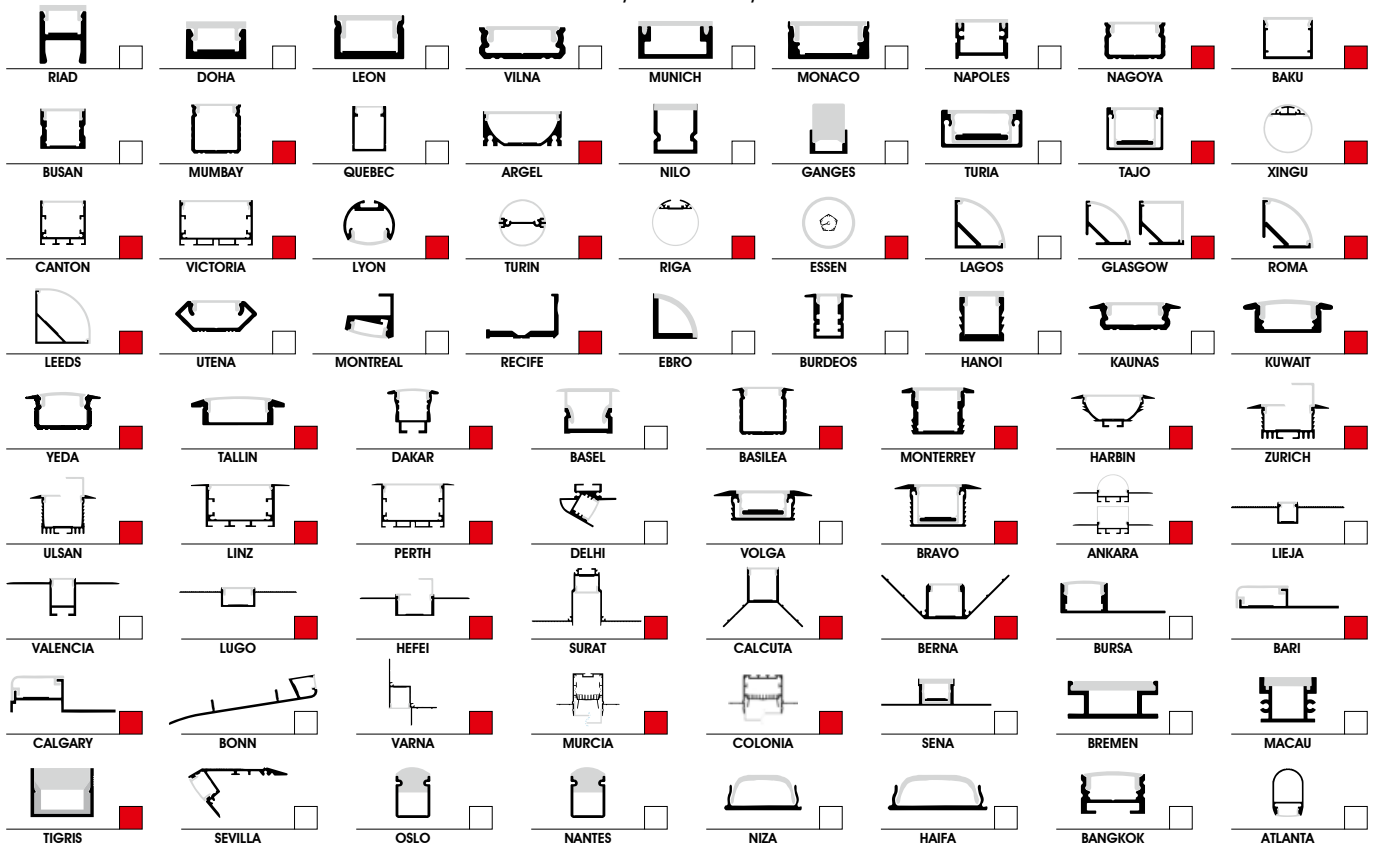

Perfil compatible con tira. / Strip compatible profile. / Profilé compatible bande. Perfil no compatible con tira. / Profile not compatible with strip. / Profilé non compatible avec la bande.

ALASKA RGB 14,4w/m · IP65 · 24v

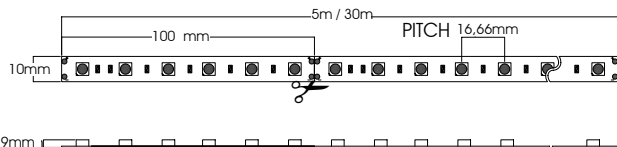

Aplicaciones: / Applications: / Applications:

Recomendada para instalaciones en uso interior y exterior. Ideal para comercios, iluminación técnica y decorativa.

Recommended for indoor and outdoor installations. Ideal for shops, technical and decorative lighting.

Recommandé pour les installations intérieures et extérieures. Idéal pour les magasins, l'éclairage technique et décoratif.

Importante instalar disipador de calor / Important to install heat sink / Important d'installer le dissipateur de chaleur.

Referencia Reference Référence	CCT(K)	Lumens/M	PVP/M
84471	RGB (Multicolor)	540 lm/m	12,50€ / M
		Rojo 108 lm/m	
		Verde 297 lm/m	
84473		Azul 90 lm/m	59,95€ / 5M



Características técnicas / Technical data / Caractéristiques techniques

Potencia rollo / Roll Power / Puissance de Roulis	72 W / 432 W
CRI CRI	>80
Leds/m Leds/m	60 LED/M
Pitch Pitch	16,66 MM
SDCM SDCM	≤3
Corte min. / Min. Cutting Length / Min. coupure	100 MM
Longitud rollo / Roll Length / Longueur du Rouleau	5 M / 30 M
Vida útil / Life time / Durée de vie	75.000 H
Temperatura trabajo / Working temperature / Température de Fonctionnement	-20+50°C
Marca punto Tc / Tc Point mark / Marque de point Tc	Si / Yes / Oui
PCB PCB	3 oz
Longitud máx. / Max length. / Longueur max.	10 M

Perfiles / Profiles / Profilés

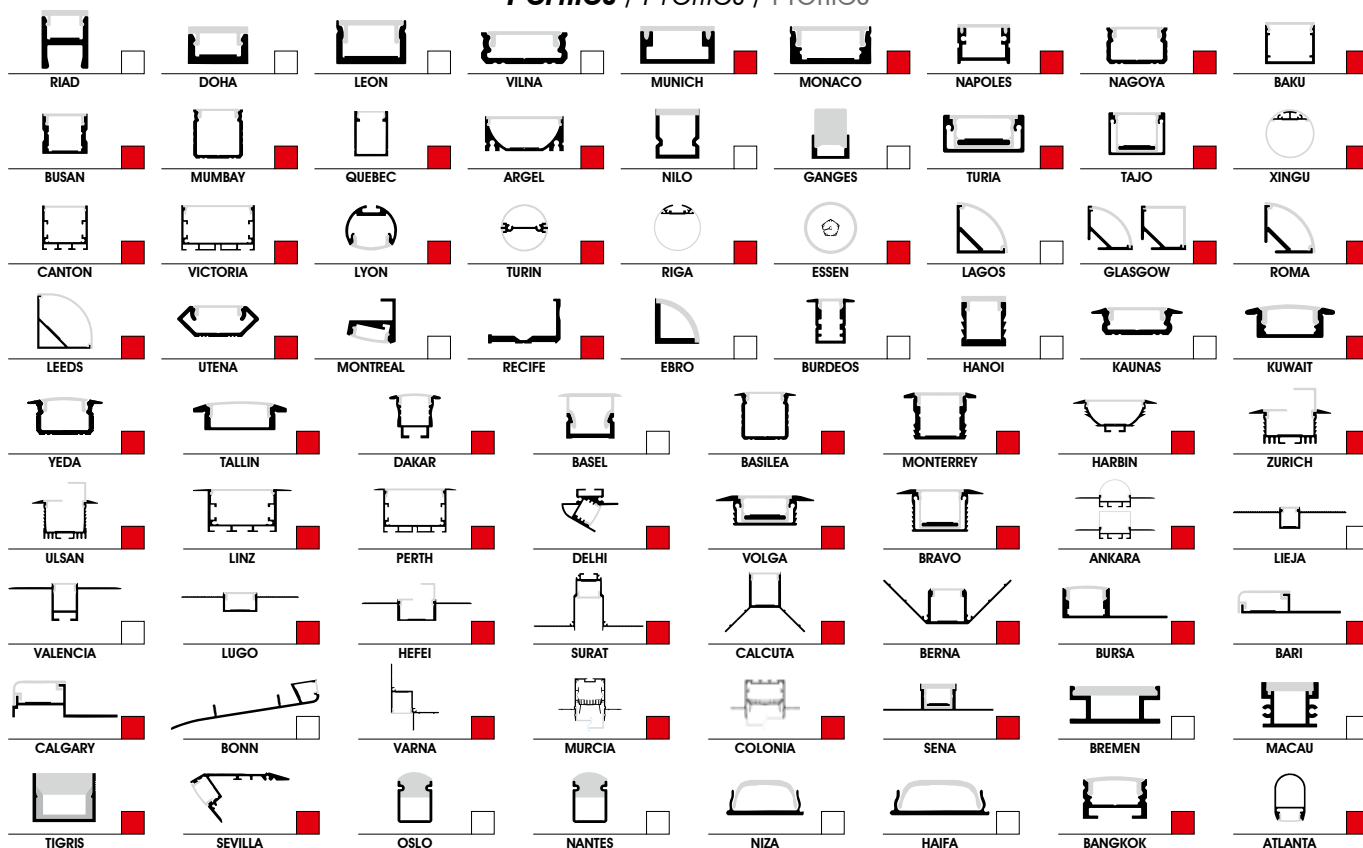

■ Perfil compatible con tira. / Strip compatible profile. / Profilé compatible bande. □ Perfil no compatible con tira. / Profile not compatible with strip. / Profilé non compatible avec la bande.

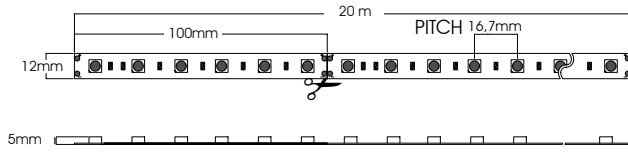

Aplicaciones: / Applications: / Applications:

Recomendada para instalaciones en uso interior y exterior. Ideal para comercios, iluminación técnica y decorativa.
 Recommended for indoor and outdoor installations. Ideal for shops, technical and decorative lighting.
 Recommandé pour les installations intérieures et extérieures. Idéal pour les magasins, l'éclairage technique et décoratif.

Importante instalar disipador de calor / Important to install heat sink / Important d'installer le dissipateur de chaleur.

Referencia Reference Référence	CCT(K)	Lumens/M	PVP/M
84046	RGB (Multicolor)	600 lm/m	17,95€
		Rojo 120 lm/m	
		Verde 330 lm/m	
		Azul 100 lm/m	



Características técnicas / Technical data / Caractéristiques techniques

Potencia rollo / Roll Power / Puissance de Roulis	288 W
CRI CRI	>80
Leds/m Leds/m	60 LED/M
Pitch Pitch	16,7 MM
SDCM SDCM	≤3
Corte min. / Min. Cutting Length / Min. coupure	100 M
Longitud rollo / Roll Length / Longueur du Rouleau	20 M
Vida útil / Life time / Durée de vie	75.000 H
Temperatura trabajo / Working temperature / Température de Fonctionnement	-20 +50°C
Marca punto Tc / Tc Point mark / Marque de point Tc	Si / Yes / Oui
PCB PCB	3 oz
Longitud máx. / Max length. / Longueur max.	10 M

Perfiles / Profiles / Profilés

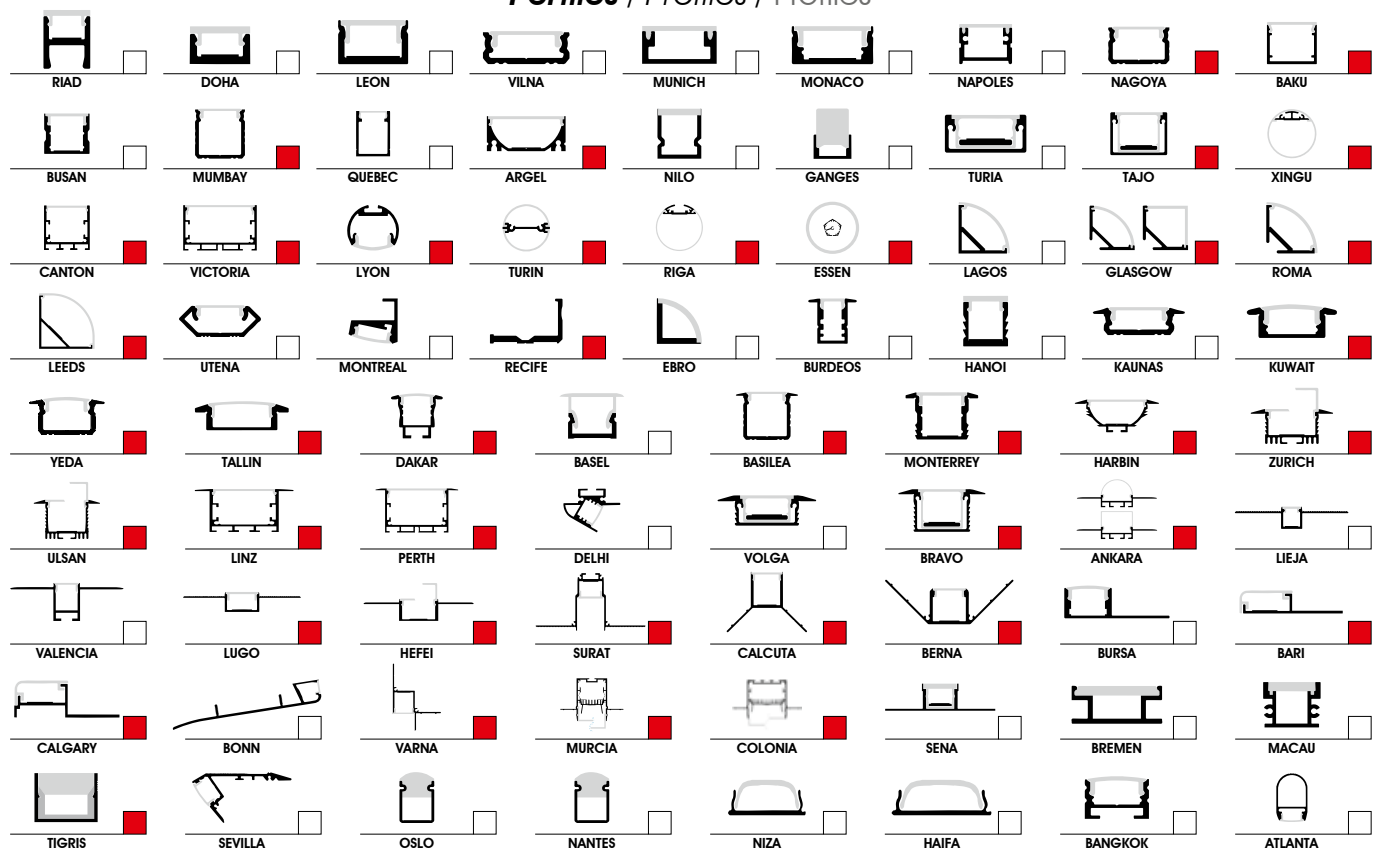

■ Perfil compatible con tira. / Strip compatible profile. / Profilé compatible bande. □ Perfil no compatible con tira. / Profile not compatible with strip. / Profilé non compatible avec la bande.

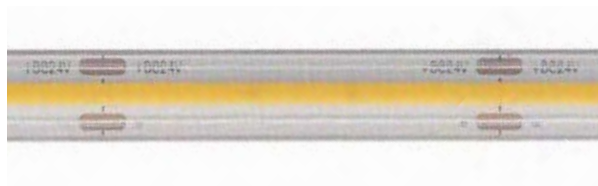
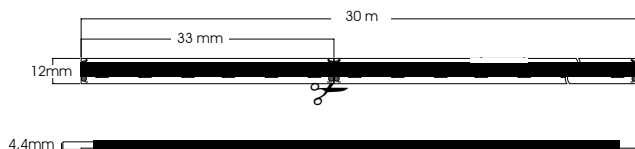

Aplicaciones: / Applications: / Applications:

Recomendada para instalaciones en uso interior y exterior. Ideal para comercios, iluminación técnica y decorativa.
 Recommended for indoor and outdoor installations. Ideal for shops, technical and decorative lighting.
 Recommandé pour les installations intérieures et extérieures. Idéal pour les magasins, l'éclairage technique et décoratif.

Importante instalar disipador de calor / Important to install heat sink / Important d'installer le dissipateur de chaleur.

Referencia Reference Référence	CCT(K)	Lumens/M	PVP/M
86054	RGB+W 3000K	860 lm/m	28,95€
86055	RGB+W 4000K	900 lm/m	

Características técnicas / Technical data / Caractéristiques techniques

Potencia rollo / Roll Power / Puissance de Roulis	600 W
CRI CRI	>90
Leds/m Leds/m	840 LED/M
Pitch Pitch	Led continuo / Continuous led / Led continue
SDCM SDCM	≤3
Corte min. / Min. Cutting Length / Min. coupure	33 M
Longitud rollo / Roll Length / Longueur du Rouleau	30 M
Vida útil / Life time / Durée de vie	75.000 H
Temperatura trabajo / Working temperature / Température de Fonctionnement	-20+50°C
Marca punto Tc / Tc Point mark / Marque de point Tc	Si / Yes / Oui
PCB PCB	3 oz
Longitud máx. / Max length. / Longueur max.	10 M

Perfiles / Profiles / Profilés

Perfil compatible con tira. / Strip compatible profile. / Profilé compatible bande. Perfil no compatible con tira. / Profile not compatible with strip. / Profilé non compatible avec la bande.

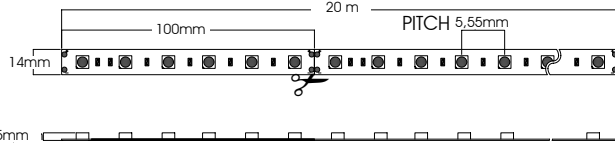

Aplicaciones: / Applications: / Applications:

Recomendada para instalaciones en uso interior y exterior. Ideal para comercios, iluminación técnica y decorativa.
 Recommended for indoor and outdoor installations. Ideal for shops, technical and decorative lighting.
 Recommandé pour les installations intérieures et extérieures. Idéal pour les magasins, l'éclairage technique et décoratif.

Importante instalar disipador de calor / Important to install heat sink / Important d'installer le dissipateur de chaleur.

Referencia Reference Référence	CCT(K)	Lumens/M	PVP/M
84048	RGB + CCT	Rojo 90 lm/m	32,95€
		Verde 360 lm/m	
		Azul 60 lm/m	
	3000k	480 lm/m	
	6000k	600 lm/m	



Características técnicas / Technical data / Caractéristiques techniques

Potencia rollo / Roll Power / Puissance de Roulis	528 W
CRI CRI	>90
Leds/m Leds/m	180 LED/M
Pitch Pitch	5,55 MM
SDCM SDCM	≤3
Corte min. / Min. Cutting Length / Min. coupure	100 MM
Longitud rollo / Roll Length / Longueur du Rouleau	20 M
Vida útil / Life time / Durée de vie	75.000 H
Temperatura trabajo / Working temperature / Température de Fonctionnement	-20+50°C
Marca punto Tc / Tc Point mark / Marque de point Tc	Si / Yes / Oui
PCB PCB	3 oz
Longitud máx. / Max length. / Longueur max.	10 M

Perfiles / Profiles / Profilés

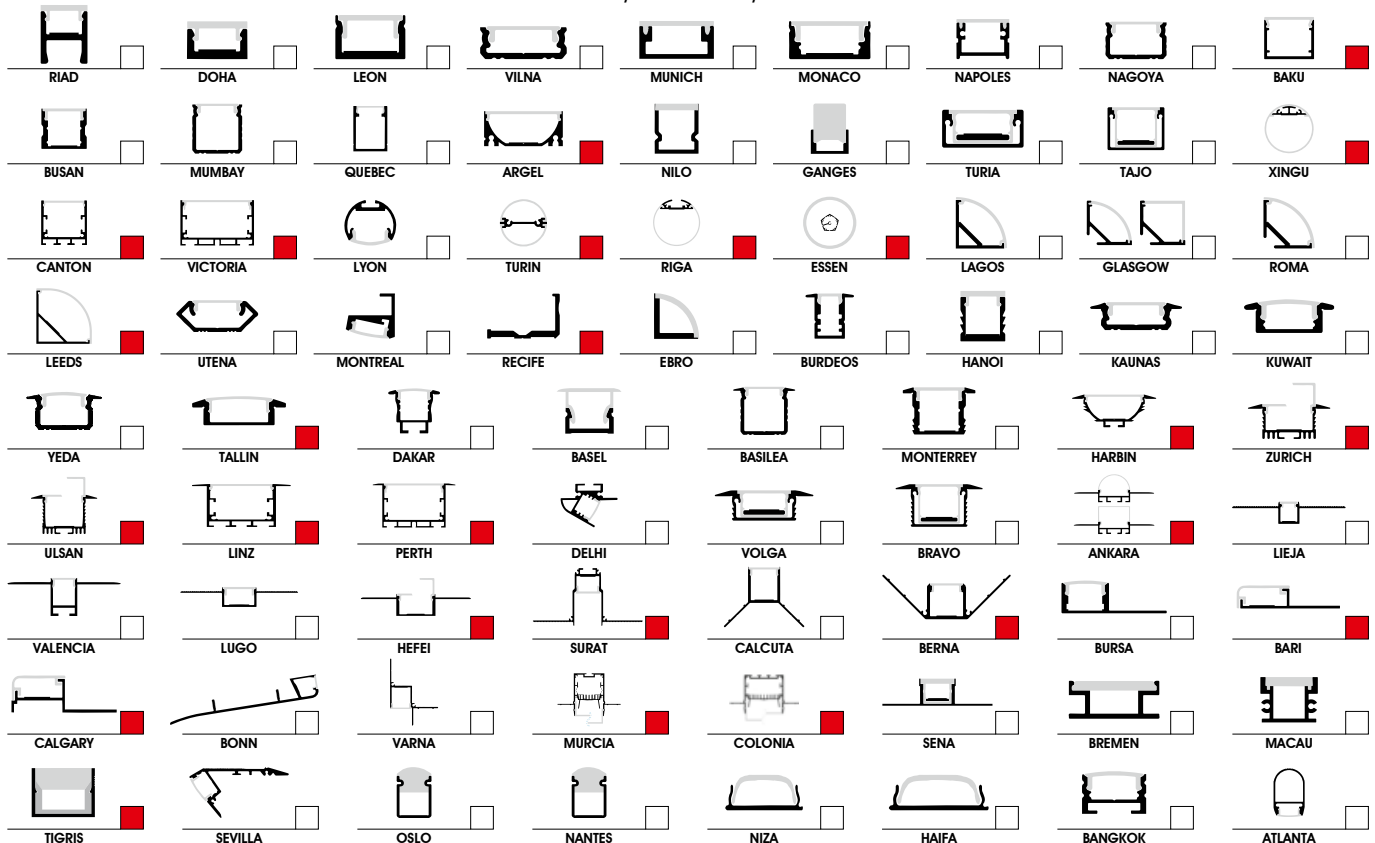

Perfil compatible con tira. / Strip compatible profile. / Profilé compatible bande. Perfil no compatible con tira. / Profile not compatible with strip. / Profilé non compatible avec la bande.

GEORGIA TUNABLE WHITE 19,2w/m · IP67 · 24v · Cri>90

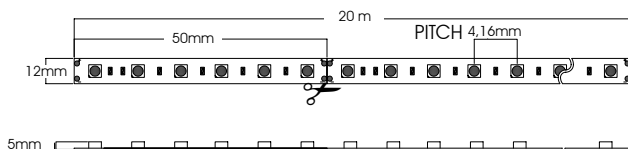

Aplicaciones: / Applications: / Applications:

Recomendada para instalaciones en uso interior y exterior. Ideal para comercios, iluminación técnica y decorativa.
Recommended for indoor and outdoor installations. Ideal for shops, technical and decorative lighting.
Recommandé pour les installations intérieures et extérieures. Idéal pour les magasins, l'éclairage technique et décoratif.

Importante instalar disipador de calor / Important to install heat sink / Important d'installer le dissipateur de chaleur.

Referencia Reference Référence	CCT(K)	Lumens/M	PVP/M
84043	○+● 1800-6500k DIMMABLE	2160 lm/m	26,85€

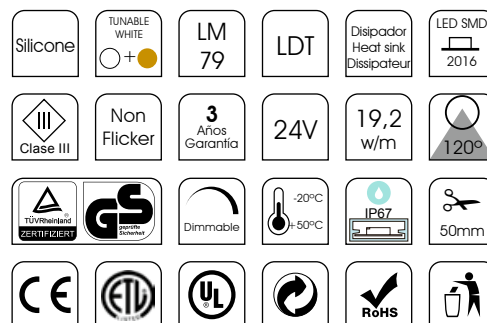

Características técnicas / Technical data / Caractéristiques techniques

Potencia rollo / Roll Power / Puissance de Rouleau	384 W
CRI CRI	>90
Leds/m Leds/m	240 LED/M
Pitch Pitch	4,16 MM
SDCM SDCM	≤3
Corte min. / Min. Cutting Length / Min. coupure	50 MM
Longitud rollo / Roll Length / Longueur du Rouleau	20 M
Vida útil / Life time / Durée de vie	75.000 H
Temperatura trabajo / Working temperature / Température de Fonctionnement	-20+50°C
Marca punto Tc / Tc Point mark / Marque de point Tc	Si / Yes / Oui
PCB PCB	3 oz
Longitud máx. / Max length. / Longueur max.	10 M

1800 to 6500K



Perfiles / Profiles / Profilés

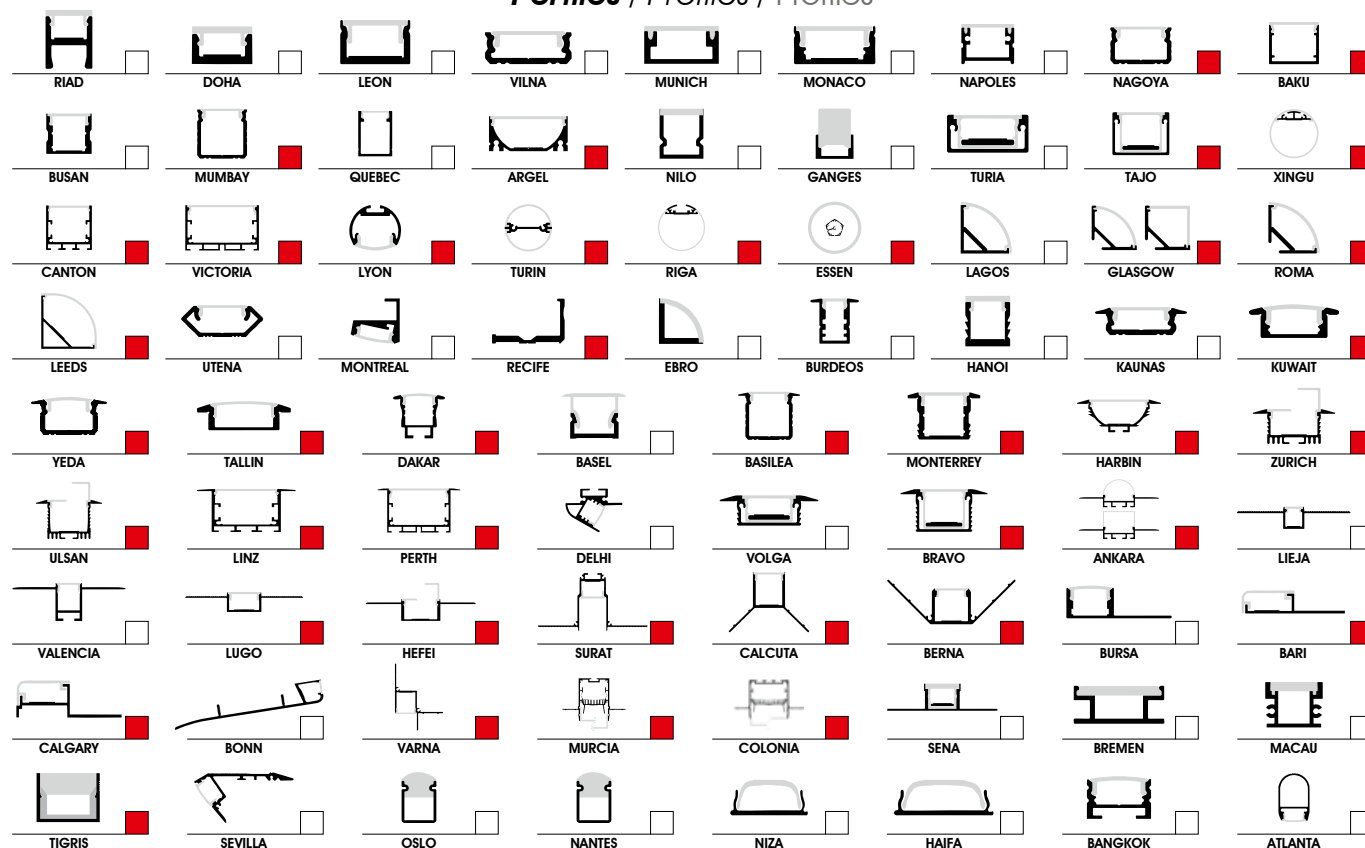

■ Perfil compatible con tira. / Strip compatible profile. / Profilé compatible bande. □ Perfil no compatible con tira. / Profile not compatible with strip. / Profilé non compatible avec la bande.

Food Series



Tecnología LED lineal flexible, para iluminación de productos de alimentación, con una alta reproducción cromática para dar la mejor iluminación a los productos a iluminar siempre con altas prestaciones en eficiencia energética.

Flexible linear LED technology, for lighting food products, with high color rendering to give the best lighting to the products to be illuminated, always with high performance in energy efficiency.

Technologie LED linéaire flexible, pour l'éclairage des produits alimentaires, avec un rendu des couleurs élevé pour donner le meilleur éclairage aux produits à éclairer, toujours avec des performances élevées en matière d'efficacité énergétique.

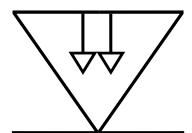

LYOPRO

LED PROFILE

DAKOTA 14,4w/m · IP67 · 24v · Cri>80

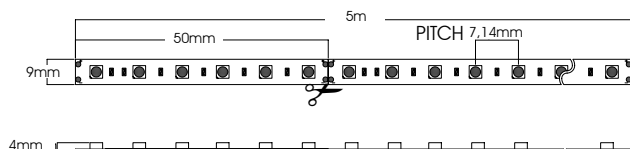

Aplicaciones: / Applications: / Applications:

Recomendada para instalaciones en uso interior y exterior. Ideal para iluminación de productos de alimentación.
 Recommended for indoor and outdoor installations. Ideal for lighting food products.

Recommandé pour les installations intérieures et extérieures. Idéal pour éclairer les produits alimentaires.

Importante instalar dissipador de calor / Important to install heat sink / Important d'installer le dissipateur de chaleur.

Referencia

Referencia Reference Référence	CCT(K)	Lumens/M	Lumens/W	PVP/M
84035	Fruta / Fruit / Fruit	2900-3200k	1120 lm/m	78 lm/W
84036	Pan / Bread / Pain	2200-2400k	980 lm/m	68 lm/W
84037	Queso / Chesse / Fromage	2600-2900k	980 lm/m	68 lm/W
84038	Pescado / Fish / Poisson	3700-4250k	1120 lm/m	78 lm/W
84039	Frescos / Fresh / Frais	3200-3850k	980 lm/m	68 lm/W
84040	Carne / Meat / Viande	1800-2000k	700 lm/m	49 lm/W

Silicone	TEST LM 80	LM 79	LDT	Dissipador Heat sink Dissipateur	LED SMD 2835
Clase III	Non Flicker	3 Años Garantía	24V	14,4 w/m	120°
TÜV Rheinland ZERTIFIZIERT	GS	Dimmable	-20°C -50°C	IP67	50mm
CE	ETL	UL	RoHS		

Características técnicas / Technical data / Caractéristiques techniques

Potencia rollo / Roll Power / Puissance de Roulis	72 W
CRI CRI	>80
Leds/m Leds/m	140 LED/M
Pitch Pitch	7,14 MM
SDCM SDCM	≤3
Corte min. / Min. Cutting Length / Min. coupure	50 MM
Longitud rollo / Roll Length / Longueur du Rouleau	5 M
Vida útil / Life time / Durée de vie	75.000 H
Temperatura trabajo / Working temperature / Température de Fonctionnement	-20+50°C
Marca punto Tc / Tc Point mark / Marque de point Tc	Si / Yes / Oui
PCB PCB	3 oz
Longitud máx. / Max length. / Longueur max.	10 M

Perfiles / Profiles / Profilés

RIAD	DOHA	LEON	VILNA	MUNICH	MONACO	NAPOLIS	NAGOYA	BAKU
BUSAN	MUMBAI	QUEBEC	ARGEL	NILO	GANGES	TURIA	TAJO	XINGU
CANTON	VICTORIA	LYON	TURIN	RIGA	ESSEN	LAGOS	GLASGOW	ROMA
LEEDS	UTENA	MONTREAL	RECIFE	EBRO	BURDEOS	HANOI	KAUNAS	KUWAIT
YEDA	TALLIN	DAKAR	BASEL	BASILEA	MONTERREY	HARBIN	ZURICH	
ULSAN	LINZ	PERTH	DELHI	VOLGA	BRAVO	ANKARA	LIEJA	
VALENCIA	LUGO	HEFEI	SURAT	CALCUTA	BERNA	BURSA	BARI	
CALGARY	BONN	VARNA	MURCIA	COLONIA	SENA	BREMEN	MACAU	
TIGRIS	SEVILLA	OSLO	NANTES	NIZA	HAIFA	BANGKOK	ATLANTA	

Perfil compatible con tira. / Strip compatible profile. / Profilé compatible bande. Perfil no compatible con tira. / Profile not compatible with strip. / Profilé non compatible avec la bande.



LYOPRO

LED PROFILE

Tecnología LED lineal flexible a 230V, para iluminación de uso interior o exterior a nivel profesional, donde se presentan distintas opciones en potencias, temperaturas de color y siempre con altas prestaciones en eficiencia energética. Con las tiras LYOPRO a 230V podemos hacer hasta 50 mts sin caída de tensión lo que facilita las instalaciones.

Flexible linear LED technology at 230V, for indoor or outdoor lighting at a professional level, where different options are presented in powers, color temperatures and always with high performance in energy efficiency. With the LYOPRO strips at 230V we can make up to 50 meters without voltage drop which facilitates the installations.

Technologie LED linéaire flexible à 230V, pour l'éclairage intérieur ou extérieur à un niveau professionnel, où différentes options sont présentées en puissances, températures de couleur et toujours avec des performances élevées en matière d'efficacité énergétique. Avec les bandes LYOPRO à 230V, nous pouvons faire jusqu'à 50 mètres sans chute de tension, ce qui facilite les installations.

Tiras 230V
Strips 230V
Bandes 230V

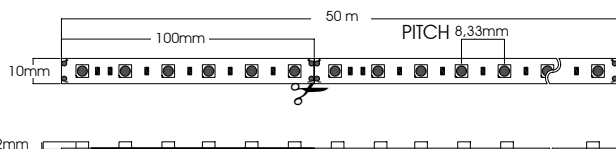

Aplicaciones: / Applications: / Applications:

Recomendada para instalaciones en uso interior y exterior. Ideal para comercios, iluminación técnica y decorativa.

Recommended for indoor and outdoor installations. Ideal for shops, technical and decorative lighting.

Recommandé pour les installations intérieures et extérieures. Idéal pour les magasins, l'éclairage technique et décoratif.

Importante instalar disipador de calor / Important to install heat sink / Important d'installer le dissipateur de chaleur.

Referencia Reference Référence	CCT(K)	Lumens/M	Lumens/W	PVP/M
84084	2700k	970 lm/m	97 lm/W	18,95€
84085	3000k	990 lm/m	99 lm/W	
84086	4000k	1010 lm/m	101 lm/W	
84087	6000k	1030 lm/m	103 lm/W	

TEST LM 80	LDT	Disipador Heat sink Dissipateur	LED SMD 2835
Silicone	3 Años Garantía	230V	10 w/m
NO SUMERGIBLE	Dimmable	-20°C -50°C	IP65
Non Flicker	CE	RoHS	120°
			100mm

Características técnicas / Technical data / Caractéristiques techniques

Potencia rollo / Roll Power / Puissance de Roulis	500 W
CRI CRI	>80
Leds/m Leds/m	120 LED/M
Pitch Pitch	8,33 MM
SDCM SDCM	≤3
Corte min. / Min. Cutting Length / Min. coupure	100 MM
Longitud rollo / Roll Length / Longueur du Rouleau	50 M
Vida útil / Life time / Durée de vie	75.000 H
Temperatura trabajo / Working temperature / Température de Fonctionnement	-20+50°C
Marca punto Tc / Tc Point mark / Marque de point Tc	Si / Yes / Oui
PCB PCB	3 oz
Longitud máx. / Max length. / Longueur max.	50 M

Kit de conexión 230v

Ref.: **80054**
PVP: 6,95€



Perfiles / Profiles / Profilés

RIAD	DOHA	LEON	VILNA	MUNICH	MONACO	NAPOLIS	NAGOYA	BAKU
BUSAN	MUMBAI	QUEBEC	ARGEL	NILO	GANGES	TURIA	TAJO	XINGU
CANTON	VICTORIA	LYON	TURIN	RIGA	ESSEN	LAGOS	GLASGOW	ROMA
LEEDS	UTENA	MONTREAL	RECIFE	EBRO	BURDEOS	HANOI	KAUNAS	KUWAIT
YEDA	TALLIN	DAKAR	BASEL	BASILEA	MONTERREY	HARBIN	ZURICH	
ULSAN	LINZ	PERTH	DELHI	VOLGA	BRAVO	ANKARA	LIEJA	
VALENCIA	LUGO	HEFEI	SURAT	CALCUTA	BERNA	BURSA	BARI	
CALGARY	BONN	VARNA	MURCIA	COLONIA	SENA	BREMEN	MACAU	
TIGRIS	SEVILLA	OSLO	NANTES	NIZA	HAIFA	BANGKOK	ATLANTA	

Perfil compatible con tira. / Strip compatible profile. / Profilé compatible bande. Perfil no compatible con tira. / Profile not compatible with strip. / Profilé non compatible avec la bande.

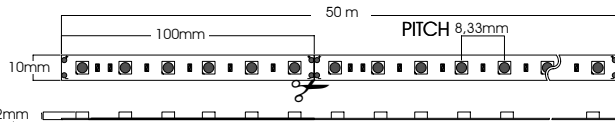

Aplicaciones: / Applications: / Applications:
Recomendada para instalaciones en uso Interior y exterior. Ideal para comercios, iluminación técnica y decorativa.
Recommended for indoor and outdoor installations. Ideal for shops, technical and decorative lighting.
Recommandé pour les installations intérieures et extérieures. Idéal pour les magasins, éclairage technique et décoratif.
Importante instalar disipador de calor / Important to install heat sink / Important d'installer le dissipateur de chaleur.

Referencia Reference Référence	CCT(K)	Lumens/M	Lumens/W	PVP/M
80018	2200k	1350 lm/m	96 lm/W	22,95€
80019	2700k	1358 lm/m	97 lm/W	
80020	3000k	1386 lm/m	99 lm/W	
80021	4000k	1414 lm/m	101 lm/W	
80022	6000k	1442 lm/m	103 lm/W	
84120	ROJO / RED / ROUGE	343 lm/m	25 lm/W	24,95€
84121	AZUL / BLUE / BLEU	252 lm/m	18 lm/W	
84122	VERDE / GREEN / VERT	1820 lm/m	130 lm/W	
84123	AMARILLO / YELLOW / JAUNE	1442 lm/m	103 lm/W	
84124	ROSA / PINK / ROSE	861 lm/m	62 lm/W	

TEST LM 80

LDT

Disipador Heat sink Dissipateur

LED SMD 2835

Silicone

3 Años Garantía

230V

14 w/m

120°

NO SUMERGIBLE

Dimmable

-20°C
-50°C

IP65

100mm

Non Flicker

CE

RoHS

Recycling symbol

Características técnicas / Technical data / Caractéristiques techniques

Potencia rollo / Roll Power / Puissance de Roulis	720 W
CRI CRI	>80
Leds/m Leds/m	120 LED/M
Pitch Pitch	8,33 MM
SDCM SDCM	≤3
Corte min. / Min. Cutting Length / Min. coupure	100 MM
Longitud rollo / Roll Length / Longueur du Rouleau	50 M
Vida útil / Life time / Durée de vie	75.000 H
Temperatura trabajo / Working temperature / Température de Fonctionnement	-20+50°C
Marca punto Tc / Tc Point mark / Marque de point Tc	Si / Yes / Oui
PCB PCB	3 oz
Longitud máx. / Max length. / Longueur max.	50 M

Kit de conexión 230v

Ref.: **80054**
PVP: 6,95€



Perfiles / Profiles / Profilés

Perfil compatible con tira. / Strip compatible profile. / Profilé compatible bande. Perfil no compatible con tira. / Profile not compatible with strip. / Profilé non compatible avec la bande.

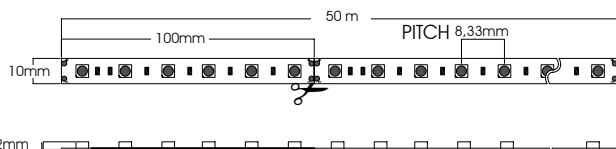

Aplicaciones: / Applications: / Applications:

Recomendada para instalaciones en uso interior y exterior. Ideal para comercios, iluminación técnica y decorativa.

Recommended for indoor and outdoor installations. Ideal for shops, technical and decorative lighting.

Recommandé pour les installations intérieures et extérieures. Idéal pour les magasins, l'éclairage technique et décoratif.

Importante instalar disipador de calor / Important to install heat sink / Important d'installer le dissipateur de chaleur.

Referencia Reference Référence	CCT(K)	Lumens/M	Lumens/W	PVP/M
80046	2700k	1746 lm/m	97 lm/W	26,95€
80047	3000k	1782 lm/m	99 lm/W	
80048	4000k	1818 lm/m	101 lm/W	
80049	6000k	1854 lm/m	103 lm/W	

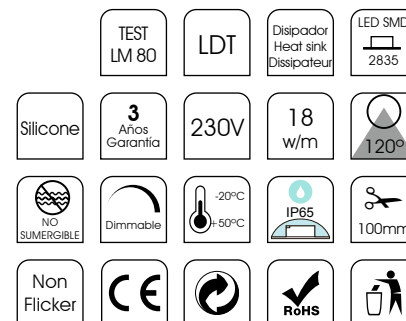

Características técnicas / Technical data / Caractéristiques techniques

Potencia rollo / Roll Power / Puissance de Rouleau	900 W
CRI CRI	>80
Leds/m Leds/m	120 LED/M
Pitch Pitch	8,33 MM
SDCM SDCM	≤3
Corte min. / Min. Cutting Length / Min. coupure	100 MM
Longitud rollo / Roll Length / Longueur du Rouleau	50 M
Vida útil / Life time / Durée de vie	75.000 H
Temperatura trabajo / Working temperature / Température de Fonctionnement	-20+50°C
Marca punto Tc / Tc Point mark / Marque de point Tc	Si / Yes / Oui
PCB PCB	3 oz
Longitud máx. / Max length. / Longueur max.	50 M

Kit de conexión 230v

Ref.: **80054**

PVP: 6,95€



Perfiles / Profiles / Profilés

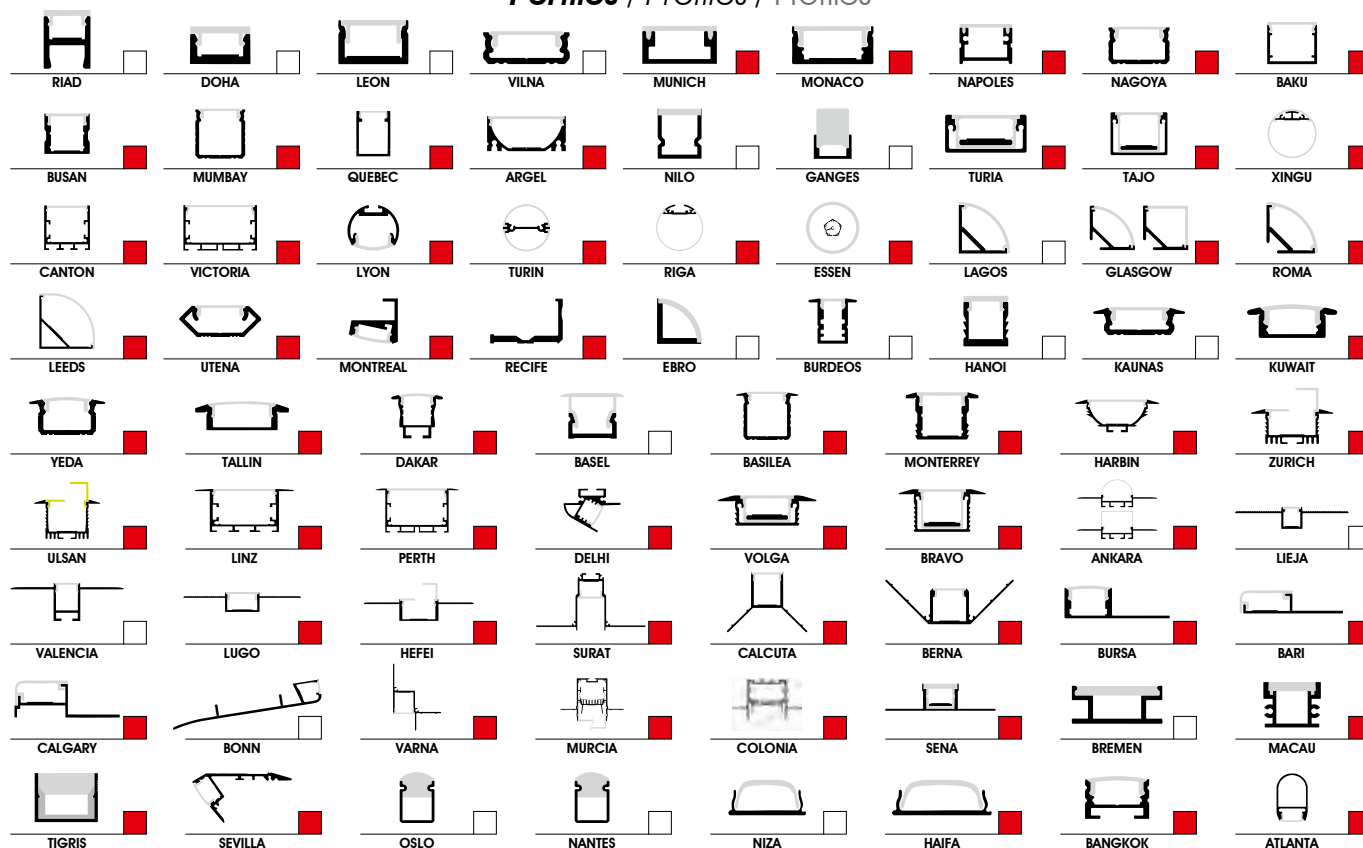

■ Perfil compatible con tira. / Strip compatible profile. / Profilé compatible bande. □ Perfil no compatible con tira. / Profile not compatible with strip. / Profilé non compatible avec la bande.

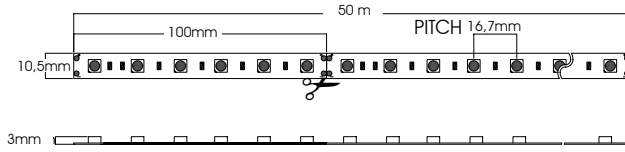

Aplicaciones: / Applications: / Applications:

Recomendada para instalaciones en uso interior y exterior. Ideal para comercios, iluminación técnica y decorativa.
Recommended for indoor and outdoor installations. Ideal for shops, technical and decorative lighting.
Recommandé pour les installations intérieures et extérieures. Idéal pour les magasins, l'éclairage technique et décoratif.

Importante instalar disipador de calor / Important to install heat sink / Important d'installer le dissipateur de chaleur.

Referencia Reference Référence	CCT(K)	Lumens/M	PVP/M
80051	RGB (Multicolor)	600 lm/m	32,95€
		Rojo 120 lm/m	
		Verde 330 lm/m	
		Azul 100 lm/m	

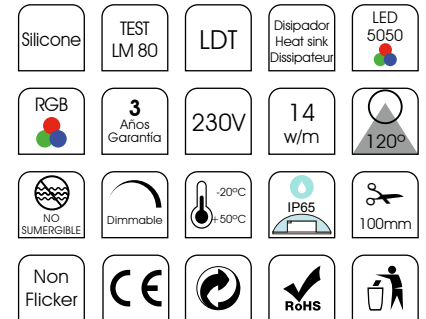

Características técnicas / Technical data / Caractéristiques techniques

Potencia rollo / Roll Power / Puissance de Roulis	700 W
CRI CRI	>80
Leds/m Leds/m	60 LED/M
Pitch Pitch	16,7 MM
SDCM SDCM	≤3
Corte min. / Min. Cutting Length / Min. coupure	100 MM
Longitud rollo / Roll Length / Longueur du Rouleau	50 M
Vida útil / Life time / Durée de vie	75.000 H
Temperatura trabajo / Working temperature / Température de Fonctionnement	-20+50°C
Marca punto Tc / Tc Point mark / Marque de point Tc	Si / Yes / Oui
PCB PCB	3 oz
Longitud máx. / Max length. / Longueur max.	30 M

Perfiles / Profiles / Profilés

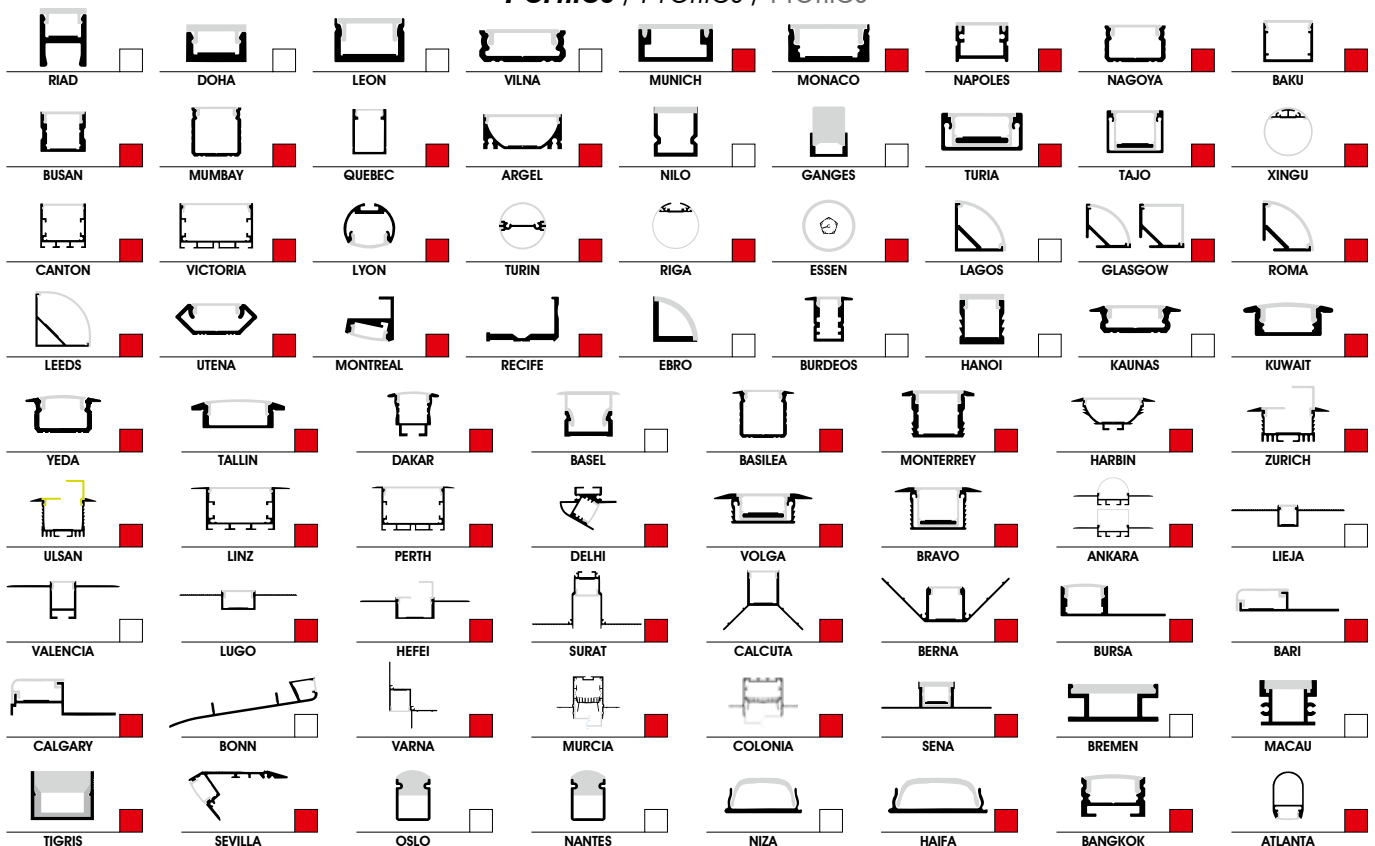

■ Perfil compatible con tira. / Strip compatible profile. / Profilé compatible bande. □ Perfil no compatible con tira. / Profile not compatible with strip. / Profilé non compatible avec la bande.

FRESNO 10w/m COB · IP65 · 230v · Cri>80

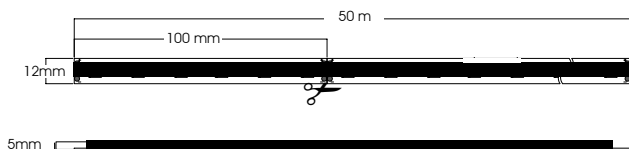

Aplicaciones: / Applications: / Applications:

Recomendada para instalaciones en uso interior y exterior. Ideal para comercios, iluminación técnica y decorativa.
Recommended for indoor and outdoor installations. Ideal for shops, technical and decorative lighting.
Recommandé pour les installations intérieures et extérieures. Idéal pour les magasins, l'éclairage technique et décoratif.

Importante instalar disipador de calor / Important to install heat sink / Important d'installer le dissipateur de chaleur.

Referencia Reference Référence	CCT(K)	Lumens/M	Lumens/W	PVP/M
84134	2700k	900 lm/m	90 lm/W	31,95€
84135	3000k	950 lm/m	95 lm/W	
84136	4000k	1000 lm/m	100 lm/W	
84137	6000k	1100 lm/m	110 lm/W	

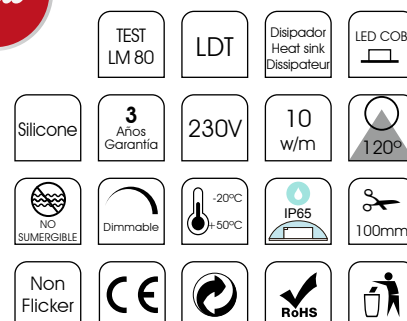

Características técnicas / Technical data / Caractéristiques techniques

Potencia rollo / Roll Power / Puissance de Roulis	500 W
CRI CRI	>80
Leds/m Leds/m	600 LED/M
Pitch Pitch	Led continuo / Continuous led / Led continue
SDCM SDCM	≤3
Corte min. / Min. Cutting Length / Min. coupure	50 MM
Longitud rollo / Roll Length / Longueur du Rouleau	20 M
Vida útil / Life time / Durée de vie	75.000 H
Temperatura trabajo / Working temperature / Température de Fonctionnement	-20+50°C
Marca punto Tc / Tc Point mark / Marque de point Tc	Si / Yes / Oui
PCB PCB	3 oz
Longitud máx. / Max length. / Longueur max.	50 M

Perfiles / Profiles / Profilés

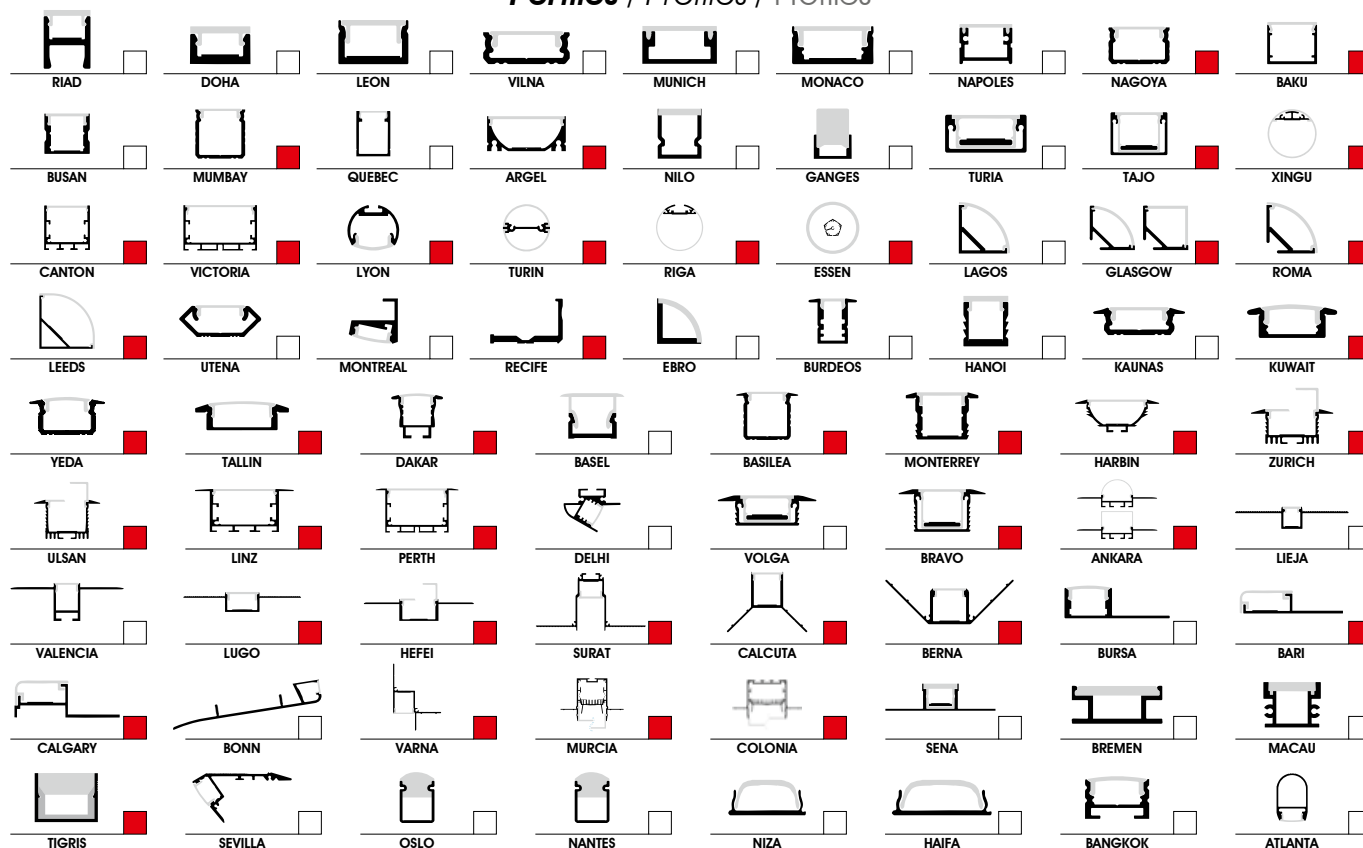

■ Perfil compatible con tira. / Strip compatible profile. / Profilé compatible bande. □ Perfil no compatible con tira. / Profile not compatible with strip. / Profilé non compatible avec la bande.

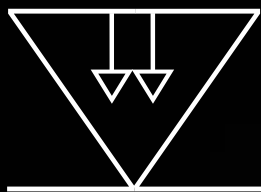

LYOPRO

LED PROFILE



Neón Flex 24V

MONTANA NEON FLEX 12w/m · IP67 · 24v · Cri>90

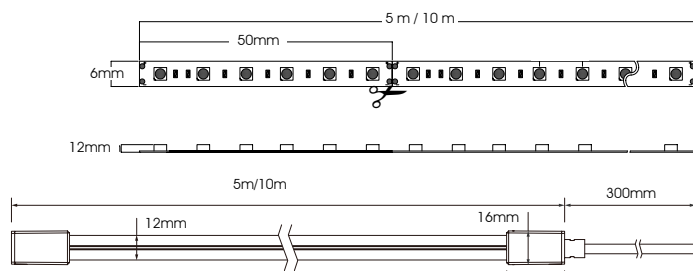

Aplicaciones: / Applications: / Applications:

Recomendada para instalaciones en uso interior y exterior. Ideal para comercios, iluminación técnica y decorativa.

Recommended for indoor and outdoor installations. Ideal for shops, technical and decorative lighting.

Recommandé pour les installations intérieures et extérieures. Idéal pour les magasins, l'éclairage technique et décoratif.

Importante instalar disipador de calor / Important to install heat sink / Important d'installer le dissipateur de chaleur.

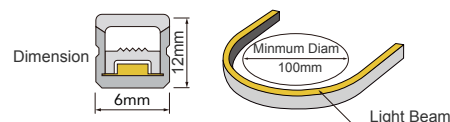

Referencia Reference Référence	CCT(K)	Lumens/M	PVP
84140	2700k	380 lm/m	89,95€ / 5M
84141	3000k	400 lm/m	
84142	4000k	420 lm/m	
84143	6000k	430 lm/m	
84151	ROJO / RED / ROUGE	110 lm/m	
84152	AZUL / BLUE / BLEU	100 lm/m	93,95€ / 5M
84153	VERDE / GREEN / VERT	360 lm/m	
84154	AMARILLO / YELLOW / JAUNE	330 lm/m	
84155	ROSA / PINK / ROSE	200 lm/m	
84240	2700k	380 lm/m	
84241	3000k	400 lm/m	
84242	4000k	420 lm/m	
84243	6000k	430 lm/m	187,95€ / 10M
84251	ROJO / RED / ROUGE	110 lm/m	
84252	AZUL / BLUE / BLEU	100 lm/m	
84253	VERDE / GREEN / VERT	360 lm/m	
84254	AMARILLO / YELLOW / JAUNE	330 lm/m	
84255	ROSA / PINK / ROSE	200 lm/m	

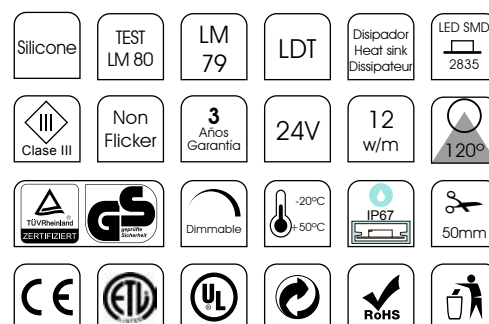
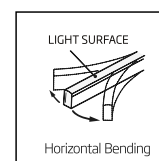

Características técnicas / Technical data / Caractéristiques techniques

Potencia rollo / Roll Power / Puissance de Roulis	60 W / 120 W
CRI CRI	>90
Leds/m Leds/m	140 LED/M
Pitch Pitch	7,14 MM
SDCM SDCM	≤3
Corte min. / Min. Cutting Length / Min. coupure	50 MM
Longitud rollo / Roll Length / Longueur du Rouleau	5 M / 10 M
Vida útil / Life time / Durée de vie	75.000 H
Temperatura trabajo / Working temperature / Température de Fonctionnement	-20+50°C
Marca punto Tc / Tc Point mark / Marque de point Tc	Si / Yes / Oui
PCB PCB	3 oz
Longitud máx. / Max length. / Longueur max.	10 M
Anti-amarilleo, Anti-UV, resistencia salina. / Anti-yellowing, Anti-UV, salt resistance. / Anti-jaunissement, Anti-UV, résistance au sel.	
Luz uniforme, sin punto de luz. / Uniform light, without point of light. / Lumière uniforme, sans point lumineux.	

ACCESORIOS/ ACCESSORIES/ ACCESSOIRES

REFERENCIA/ REFERENCE/ RÉFÉRENCE	DESCRIPCIÓN/ DESCRIPTION/ DESCRIPTION	PVP
84145	PERFIL RECTO 1M / STRAIGHT PROFILE 1M / PROFILÉ DROIT 1M	6,95€
84147	CLIP DE SUJECION / SUPPORT CLIP / CLIP SUPPORT	0,99€
84148	TAPA FINAL / END CAP / EMBOUT DE FERMETURE FINALE	0,85€
84149	TAPA INICIAL / INITIAL COVER / EMBOUT DE FERMETURE INITIALE	0,85€
84150	TAPA INICIAL LATERAL / SIDE INITIAL COVER / EMBOUT DE FERMETURE INITIALE LATÉRALE	0,85€

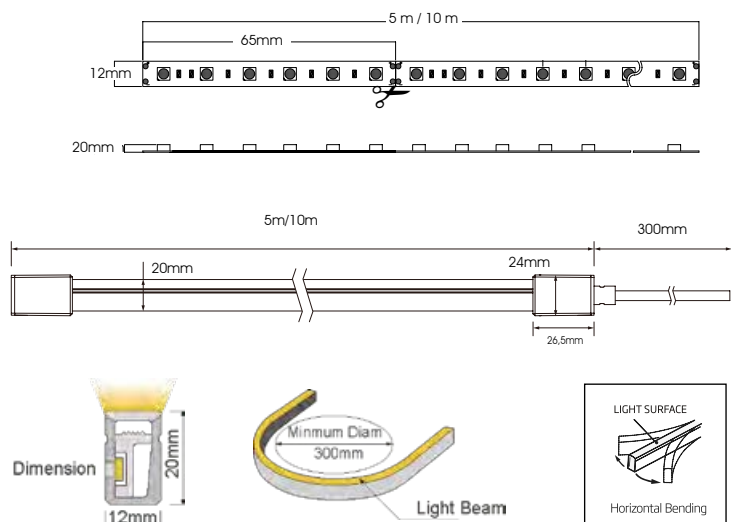

Aplicaciones: / Applications: / Applications:
Recomendada para instalaciones en uso interior y exterior. Ideal para comercios, iluminación técnica y decorativa.
Recommended for indoor and outdoor installations. Ideal for shops, technical and decorative lighting.
Recommandé pour les installations intérieures et extérieures. Idéal pour les magasins, l'éclairage technique et décoratif.

Importante instalar disipador de calor / Important to install heat sink / Important d'installer le dissipateur de chaleur.

Referencia Reference Référence	CCT(K)	Lumens/M	PVP/M
84160	RGB (Multicolor)		199,95€ / 5M
84161	RGBW3000K	400 lm/m	269,95€ / 5M
84162	RGBW4000K	420 lm/m	269,95€ / 5M
84260	RGB (Multicolor)		399,95€ / 10M
84261	RGBW3000K	400 lm/m	539,95€ / 10M
84262	RGBW4000K	420 lm/m	539,95€ / 10M

Características técnicas / Technical data / Caractéristiques techniques

Potencia rollo / Roll Power / Puissance de Roulis	60 W / 120 W
CRI CRI	>90
Leds/m Leds/m	140 LED/M
Pitch Pitch	7,14 MM
SDCM SDCM	≤3
Corte min. / Min. Cutting Length / Min. coupure	65 MM
Longitud rollo / Roll Length / Longueur du Rouleau	5 M / 10 M
Vida útil / Life time / Durée de vie	75.000 H
Temperatura trabajo / Working temperature / Température de Fonctionnement	-20+50°C
Marca punto Tc / Tc Point mark / Marque de point Tc	Si / Yes / Oui
PCB PCB	3 oz
Longitud máx. / Max length. / Longueur max.	10 M
Anti-amarilleo, Anti-UV, resistencia salina. / Anti-yellowing, Anti-UV, salt resistance. / Anti-jaunissement, Anti-UV, résistance au sel.	
Luz uniforme, sin punto de luz. / Uniform light, without point of light. / Lumière uniforme, sans point lumineux.	

ACCESORIOS/ ACCESSORIES/ ACCESSOIRES

REFERENCIA/ REFERENCE/ RÉFÉRENCE	DESCRIPCIÓN/ DESCRIPTION/ DESCRIPTION	PVP
84163	PERFIL RECTO 1M / STRAIGHT PROFILE 1M / PROFILÉ DROIT 1M	8,95€
84164	CLIP DE SUJECION / SUPPORT CLIP / CLIP SUPPORT	0,99€
84165	TAPA FINAL / END CAP / EMBOUT DE FERMETURE FINALE	1,25€
84166	TAPA INICIAL / INITIAL COVER / EMBOUT DE FERMETURE INITIALE	1,25€
84167	TAPA INICIAL LATERAL / SIDE INITIAL COVER / EMBOUT DE FERMETURE INITIALE LATÉRALE	1,25€



Neón Flex 230V



Tecnología LED lineal flexible a 230V, para iluminación de uso interior o exterior a nivel profesional, donde se presentan distintas opciones en potencias, temperaturas de color y siempre con altas prestaciones en eficiencia energética. Con el Neón LYOPRO a 230V podemos hacer hasta 50 mts sin caída de tensión lo que facilita las instalaciones.

Flexible linear LED technology at 230V, for lighting for indoor or outdoor use at a professional level, where there are different options in power, color temperatures and always with high performance in energy efficiency. With 230V LYOPRO Neon we can do up to 50 meters without voltage drop, which makes installation easier.

Technologie LED linéaire flexible à 230V, pour l'éclairage à usage intérieur ou extérieur à un niveau professionnel, où il existe différentes options de puissance, de températures de couleur et toujours avec des performances élevées en matière d'efficacité énergétique. Avec 230V LYOPRO Neon nous pouvons faire jusqu'à 50 mètres sans chute de tension, ce qui facilite l'installation.

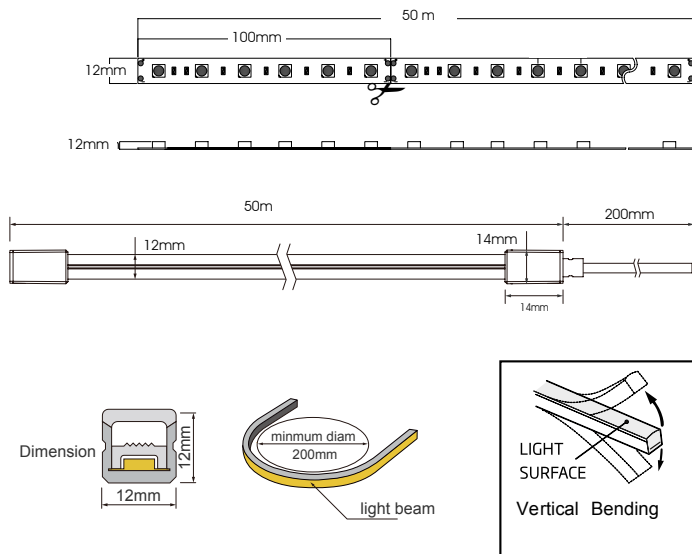

Aplicaciones: / Applications: / Applications:

Recomendada para instalaciones en uso interior y exterior. Ideal para comercios, iluminación técnica y decorativa.
Recommended for indoor and outdoor installations. Ideal for shops, technical and decorative lighting.
Recommandé pour les installations intérieures et extérieures. Idéal pour les magasins, l'éclairage technique et décoratif.

Importante Instalar disipador de calor / Important to install heat sink / Important d'installer le dissipateur de chaleur.

Referencia Reference Référence		CCT(K)	Lumens/M	PVP/M
84300		2700k	360 lm/m	32,95€
84301		3000k	370 lm/m	
84302		4000k	380 lm/m	
84303		6000k	390 lm/m	
84304		ROJO / RED / ROUGE	100 lm/m	34,95€
84305		AZUL / BLUE / BLEU	75 lm/m	
84306		VERDE / GREEN / VERT	350 lm/m	
84307		AMARILLO / YELLOW / JAUNE	320 lm/m	
84308		ROSA / PINK / ROSE	190 lm/m	

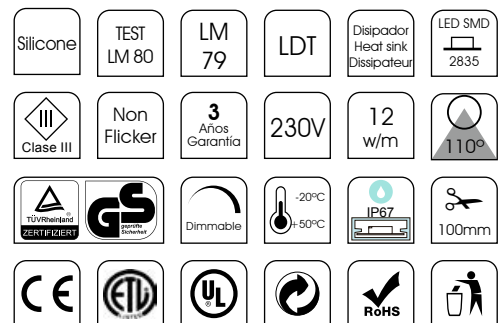

Características técnicas / Technical data / Caractéristiques techniques

Potencia rollo / Roll Power / Puissance de Roulis	600 W
CRI CRI	>80
Leds/m Leds/m	120 LED/M
Pitch Pitch	8,33 MM
SDCM SDCM	≤3
Corte min. / Min. Cutting Length / Min. coupure	100 MM
Longitud rollo / Roll Length / Longueur du Rouleau	50 M
Vida útil / Life time / Durée de vie	75.000 H
Temperatura trabajo / Working temperature / Température de Fonctionnement	-20+50°C
Marca punto Tc / Tc Point mark / Marque de point Tc	Si / Yes / Oui
PCB PCB	3 oz
Longitud máx. / Max length. / Longueur max.	50 M

ACCESORIOS/ ACCESSORIES/ ACCESSOIRES

REFERENCIA/ REFERENCE/ RÉFÉRENCE	DESCRIPCIÓN/ DESCRIPTION/ DESCRIPTION	PVP
84309	TAPA INICIAL / INITIAL COVER / EMBOUT DE FERMETURE INITIALE	0,99€
84310	TAPA FINAL / END CAP / EMBOUT DE FERMETURE FINALE	0,99€
84311	CLIP DE SUJECION / SUPPORT CLIP / CLIP SUPPORT	1,15€
84312	PERFIL RECTO 1M / STRAIGHT PROFILE 1M / PROFILÉ DROIT 1M	9,95€

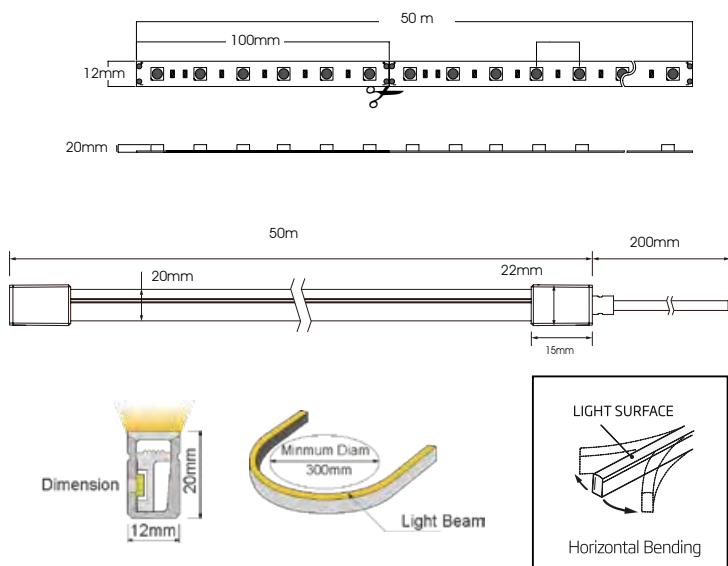

Aplicaciones: / Applications: / Applications:

Recomendada para instalaciones en uso interior y exterior. Ideal para comercios, iluminación técnica y decorativa.

Recommended for indoor and outdoor installations. Ideal for shops, technical and decorative lighting.

Recommandé pour les installations intérieures et extérieures. Idéal pour les magasins, l'éclairage technique et décoratif.

Importante instalar disipador de calor / Important to install heat sink / Important d'installer le dissipateur de chaleur.

Referencia Reference Référence	CCT(K)	Lumens/M	PVP/M
84330	2700k	360 lm/m	34,95€
84331	3000k	370 lm/m	
84332	4000k	380 lm/m	
84333	6000k	390 lm/m	
84334	ROJO / RED / ROUGE	100 lm/m	36,95€
84335	AZUL / BLUE / BLEU	75 lm/m	
84336	VERDE / GREEN / VERT	350 lm/m	
84337	AMARILLO / YELLOW / JAUNE	320 lm/m	
84338	ROSA / PINK / ROSE	190 lm/m	

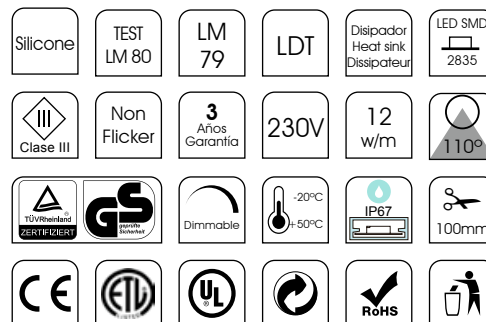

Características técnicas / Technical data / Caractéristiques techniques

Potencia rollo / Roll Power / Puissance de Roulis	600 W
CRI CRI	>80
Leds/m Leds/m	120 LED/M
Pitch Pitch	8,33 MM
SDCM SDCM	≤3
Corte min. / Min. Cutting Length / Min. coupure	100 MM
Longitud rollo / Roll Length / Longueur du Rouleau	50 M
Vida útil / Life time / Durée de vie	75.000 H
Temperatura trabajo / Working temperature / Température de Fonctionnement	-20+50°C
Marca punto Tc / Tc Point mark / Marque de point Tc	Si / Yes / Oui
PCB PCB	3 oz
Longitud máx. / Max length. / Longueur max.	50 M

ACCESORIOS/ ACCESSORIES/ ACCESSOIRES

REFERENCIA/ REFERENCE/ RÉFÉRENCE	DESCRIPCIÓN/ DESCRIPTION/ DESCRIPTION	PVP
84339	TAPA INICIAL / INITIAL COVER / EMBOUT DE FERMETURE INITIALE	0,99€
84340	TAPA FINAL / END CAP / EMBOUT DE FERMETURE FINALE	0,99€
84341	CLIP DE SUJECION / SUPPORT CLIP / CLIP SUPPORT	1,45€
84342	PERFIL RECTO 1M / STRAIGHT PROFILE 1M / PROFILÉ DROIT 1M	10,95€



LYOPRO

LED PROFILE

**DYNAMIC
LIGHTING**



REALIZAMOS TODOS TUS PROYECTOS DE ILUMINACION DYNAMICA.
¡¡CONSULTANOS!!

WE CARRY OUT ALL YOUR DYNAMIC LIGHTING PROJECTS.
ASK US!!

NOUS RÉALISONS TOUS VOS PROJETS D'ÉCLAIRAGE DYNAMIQUE.
DEMANDEZ NOUS!!

Dynamic Lighting es un sistema de iluminación y control digital mediante protocolos DMX/SPI.

La iluminación dinámica nos va a permitir adentrarnos en un mundo de sensaciones, dando a los espacios a iluminar, un gran dinamismo, movimiento, elasticidad y experiencias únicas.

Lyopro ha desarrollado una gama de productos que nos permiten adaptarnos y personalizar cualquier proyecto, desde el más pequeño y simple al más grande y complejo.

Dynamic Lighting is a digital lighting and control system using DMX/SPI protocols.

Dynamic lighting will allow us to enter a world of sensations, giving the spaces to be illuminated great dynamism, movement, elasticity and unique experiences.

Lyopro has developed a range of products that allow us to adapt and personalize any project, from the smallest and simplest to the largest and most complex.

Dynamic Lighting est un système d'éclairage et de contrôle numérique utilisant les protocoles DMX/SPI.

L'éclairage dynamique nous permettra d'entrer dans un monde de sensations, donnant aux espaces à éclairer un grand dynamisme, du mouvement, de l'élasticité et des expériences uniques.

Lyopro a développé une gamme de produits qui nous permettent d'adapter et de personnaliser tout projet, du plus petit et simple au plus grand et complexe.

Lyopro te ayuda a llevar a cabo todos los procesos de tu proyecto
Lyopro helps you carry out all the processes of your project
Lyopro vous aide à réaliser toutes les démarches de votre projet



Diseño
Design
Conception

Damos un servicio de asesoramiento a nuestros clientes para que puedan convertir en realidad sus ideas.
We provide an advisory service to our clients so that they can turn their ideas into reality.
Nous fournissons un service de conseil à nos clients afin qu'ils puissent concrétiser leurs idées.



Fabricación
Manufacturing
Fabrication

Elaboramos y preparamos todos los productos necesarios para realizar el proyecto.
We prepare and prepare all the products necessary to carry out the project.
Nous préparons et préparons tous les produits nécessaires à la réalisation du projet.



Instalación
Facility
Facilité

Asesoramos a los clientes para que puedan realizar una perfecta instalación.
We advise clients so that they can carry out a perfect installation.
Nous conseillons les clients afin qu'ils puissent réaliser une installation parfaite.



Programación
Programming
La programmation

Realizamos la programación de forma remota o presencial dependiendo de la complejidad del proyecto.
We carry out programming remotely or in person depending on the complexity of the project.
Nous effectuons la programmation à distance ou en personne selon la complexité du projet.

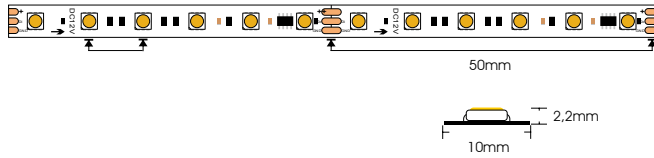

Aplicaciones: / Applications: / Applications:

Recomendada para instalaciones en uso interior. Ideal para comercios, iluminación técnica y decorativa.

Recommended for indoor installations. Ideal for shops, technical and decorative lighting.

Recommandé pour les installations intérieures. Idéal pour les magasins, l'éclairage technique et décoratif.

Importante Instalar disipador de calor / Important to install heat sink / Important d'installer le dissipateur de chaleur.

Referencia Reference Référence	SPI-CI	PVP/M
84504	RGB (Multicolor)	39,95€

Características técnicas / Technical data / Caractéristiques techniques

Potencia rollo / Roll Power / Puissance de Roulis	72 W
CRI CRI	>80
Leds/m Leds/m	60 LED/M -20 PIXELS
Corte min. / Min. Cutting Length / Min. coupure	50 MM
Longitud rollo / Roll Length / Longueur du Rouleau	5 M
Vida útil / Life time / Durée de vie	50.000 H
Temperatura trabajo / Working temperature / Température de Fonctionnement	-20+50°C



Sistema de control / Control system / Système de contrôle

WIFI CONTROL
Ref.: 84780
PVP: 89,95€



MADRIX CONTROL



DMX CONTROL



TROY 16w/m · IP20 · 24v · SPI

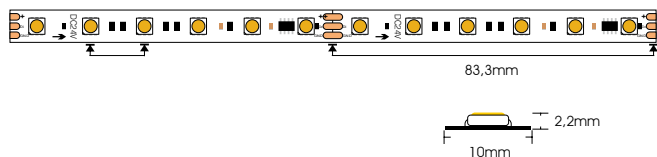

Aplicaciones: / Applications: / Applications:

Recomendada para instalaciones en uso interior. Ideal para comercios, iluminación técnica y decorativa.

Recommended for indoor installations. Ideal for shops, technical and decorative lighting.

Recommandé pour les installations intérieures. Idéal pour les magasins, l'éclairage technique et décoratif.

Importante instalar disipador de calor / Important to install heat sink / Important d'installer le dissipateur de chaleur.

Referencia Reference Référence	SPI-CI	PVP/M
84595	RGBW3000K	49,95€
84596	RGBW4000K	49,95€

Características técnicas / Technical data / Caractéristiques techniques

Potencia rollo / Roll Power / Puissance de Roulis	80 W
CRI CRI	>80
Leds/m Leds/m	60 LED/M -12 PIXELS
Corte min. / Min. Cutting Length / Min. coupure	83,3 MM
Longitud rollo / Roll Length / Longueur du Rouleau	5 M
Vida útil / Life time / Durée de vie	50.000 H
Temperatura trabajo / Working temperature / Température de Fonctionnement	-20+50°C



Sistema de control / Control system / Système de contrôle

WIFI CONTROL
Ref.: 84780
PVP: 89,95€



MADRIX CONTROL



DMX CONTROL



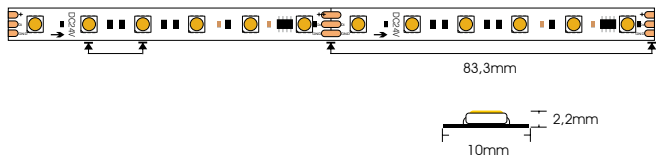

Aplicaciones: / Applications: / Applications:

Recomendada para instalaciones en uso interior. Ideal para comercios, iluminación técnica y decorativa.

Recommended for indoor installations. Ideal for shops, technical and decorative lighting.

Recommandé pour les installations intérieures. Idéal pour les magasins, l'éclairage technique et décoratif.

Importante instalar disipador de calor / Important to install heat sink / Important d'installer le dissipateur de chaleur.

Referencia Reference Référence	SPI-CI	PVP/M
84545	RGBW3000K	59,95€
84546	RGBW4000K	59,95€

Características técnicas / Technical data / Caractéristiques techniques

Potencia rollo / Roll Power / Puissance de Roulis	86 W
CRI CRI	>80
Leds/m Leds/m	60 LED/M -12 PIXELS
Corte min. / Min. Cutting Length / Min. coupure	83,3 MM
Longitud rollo / Roll Length / Longueur du Rouleau	5 M
Vida útil / Life time / Durée de vie	50.000 H
Temperatura trabajo / Working temperature / Température de Fonctionnement	-20+50°C



Sistema de control / Control system / Système de contrôle

WIFI CONTROL
Ref.: 84780
PVP: 89,95€



MADRIX CONTROL



DMX CONTROL



TUCAN NEON FLEX 16w/m · IP67 · 24v · SPI

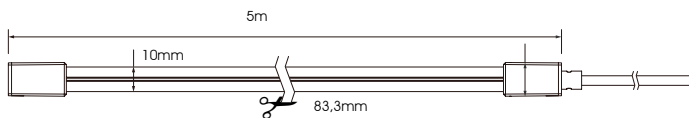

Aplicaciones: / Applications: / Applications:

Recomendada para instalaciones en uso interior y exterior. Ideal para comercios, iluminación técnica y decorativa.

Recommended for indoor and outdoor installations. Ideal for shops, technical and decorative lighting.

Recommandé pour les installations intérieures et extérieures. Idéal pour les magasins, l'éclairage technique et décoratif.

Importante instalar disipador de calor / Important to install heat sink / Important d'installer le dissipateur de chaleur.

Referencia Reference Référence	SPI-CI	PVP/M
84695	RGBW3000K	79,95€
84696	RGBW4000K	79,95€

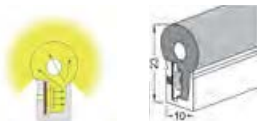

Silicone	TEST LM 80	LM 79	LDT	Disipador Heat sink Dissipateur	LED 5050 RGB+W
Clase III	Non Flicker	3 Años Garantía	24V	16 w/m	270°
10 Year Quality Certified	GS	Dimmable	-20°C +50°C	IP67	83,3mm
CE	ETL	UL	RoHS		

Características técnicas / Technical data / Caractéristiques techniques

Potencia rollo / Roll Power / Puissance de Roullis	80 W
CRI CRI	> 80
Leds/m Leds/m	60 LED/M - 12 PIXELS
Corte min. / Min. Cutting Length / Min. coupure	83,3 MM
Longitud rollo / Roll Length / Longueur du Rouleau	5 M
Vida útil / Life time / Durée de vie	50.000 H
Temperatura trabajo / Working temperature / Température de Fonctionnement	-20+50°C

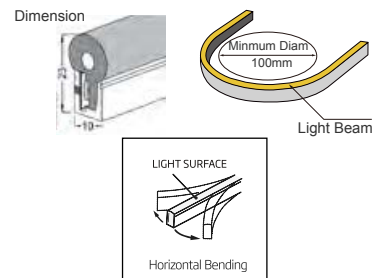

Sistema de control / Control system / Système de contrôle

WIFI CONTROL
Ref.: 84780
PVP: 89,95€



MADRIX CONTROL



DMX CONTROL



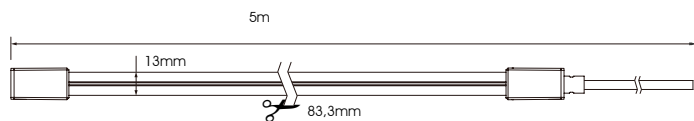

Aplicaciones: / Applications: / Applications:

Recomendada para instalaciones en uso interior y exterior. Ideal para comercios, iluminación técnica y decorativa.
 Recommended for indoor and outdoor installations. Ideal for shops, technical and decorative lighting.
 Recommandé pour les installations intérieures et extérieures. Idéal pour les magasins, l'éclairage technique et décoratif.

Importante instalar dissipador de calor / Important to install heat sink / Important d'installer le dissipateur de chaleur.

Silicone	TEST LM 80	LM 79	LDT	Dissipador Heat sink Dissipateur	LED SMD 2835
Class III	Non Flicker	3 Años Garantía	24V	19,2 w/m	120°
TÜV Rheinland CERTIFIED	GS	Dimmable	-20°C -50°C	IP67	83,3mm
CE	ETL	UL	RoHS		

Referencia Reference Référence	SPI-CI	PVP/M
84745	RGBW3000K	89,95€
84746	RGBW4000K	89,95€



Características técnicas / Technical data / Caractéristiques techniques

Potencia rollo / Roll Power / Puissance de Roulis	96 W
CRI CRI	> 80
Leds/m Leds/m	60 LED/M -12 PIXELS
Corte min. / Min. Cutting Length / Min. coupure	83,3 MM
Longitud rollo / Roll Length / Longueur du Rouleau	5 M
Vida útil / Life time / Durée de vie	50.000 H
Temperatura trabajo / Working temperature / Température de Fonctionnement	-20+50°C

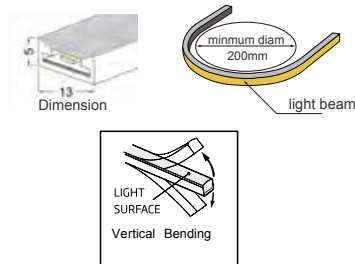

Sistema de control / Control system / Système de contrôle

WIFI CONTROL
 Ref.: 84780
 PVP: 89,95€



MADRIX CONTROL



DMX CONTROL



LYOPRO ha desarrollado una amplia gama de tiras Neón de alta calidad para aplicaciones de iluminación profesional y con unas altas prestaciones para poder dar soluciones en las instalaciones mas exigentes, que van desde piscinas, aguas termales, saunas etc...

LYOPRO has developed a wide range of high quality Neon strips for professional lighting applications and with high performance to be able to provide solutions in the most demanding installations, ranging from swimming pools, hot springs, saunas, etc...

LYOPRO a développé une large gamme de bandes néon de haute qualité pour des applications d'éclairage professionnelles et avec des performances élevées pour pouvoir fournir des solutions dans les installations les plus exigeantes, allant des piscines, sources chaudes, saunas, etc...

HYDRA PISCINAS / SWIMMING POOLS / PISCINES

HYDRA, el neón LED flexible IP68, le ofrece una experiencia sin precedentes. Pura libertad en diseño de iluminación para aplicaciones subacuáticas en interiores y exteriores. Iluminación continua, múltiples opciones de color, longitud personalizada y dos direcciones de flexión. Como luminaria subacuática profesional, cuenta con la certificación UL 676 y es resistente al óxido, al cloro y a los rayos UV, comprobado mediante pruebas exhaustivas, con el objetivo de crear el ambiente seguro y acogedor fuera de sus expectativas.

HYDRA, the IP68 rated flexible LED neon, gives you unprecedented freedom in lighting design for indoor and outdoor underwater applications, featured with continuous glow, multiple color options, custom length, and two bending directions. As a professional underwater luminaire, it is UL 676 certified and resistant to rust, chlorine, UV proven by extensive tests, aiming to create the safe and cozy ambient out of your expectation.

HYDRA, le néon LED flexible classé IP68, vous offre une liberté dans la conception de l'éclairage pour les applications sous-marines intérieures et extérieures, doté d'une lueur continue, de plusieurs options de couleurs, d'une longueur personnalisée et de deux directions de flexion. En tant que luminaire sous-marin professionnel, il est certifié UL 676 et résistant à la rouille, au chlore, aux UV prouvé par des tests approfondis, visant à créer l'ambiance sûre et confortable hors de vos attentes.



HYDRA AGUAS TERMALES Y JACUZZIS / THERMAL WATERS AND JACUZZIS / EAUX THERMALES ET JACUZZIS

VOLCAN SAUNAS / SAUNAS / SAUNAS

La tira Neón LYOPRO para aguas termales, jacuzzis y saunas está diseñada para sumergirse en aguas termales y jacuzzis. Debido a sus características técnicas, están preparadas para soportar los vapores, humedades, temperaturas etc... que requieren estas instalaciones.

The LYOPRO Neon strip for hot springs, jacuzzis and saunas is designed to be immersed in hot springs and jacuzzis. Due to their technical characteristics, they are prepared to withstand the vapors, humidity, temperatures, etc... that these facilities require.

La bande néon LYOPRO pour sources chaudes, jacuzzis et saunas est conçue pour être immergée dans les sources chaudes et les jacuzzis. De par leurs caractéristiques techniques, ils sont préparés pour résister aux vapeurs, humidité, températures, etc... que nécessitent ces installations.

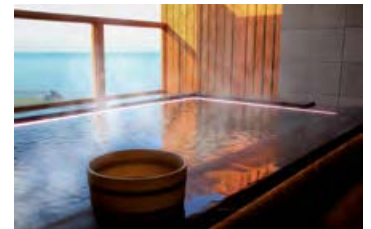

DORUK AMBIENTES EXPLOSIVOS Y PELIGROSOS / EXPLOSIVE AND DANGEROUS ENVIRONMENTS / ENVIRONNEMENTS EXPLOSIFS ET DANGEREUX

Desde el transporte, la producción, el almacenamiento hasta procesamiento y distribución, explosiones e incendios se encuentran entre los principales peligros en toda la Industria de petróleo y gas. Equipo certificado a prueba de explosiones con clasificación T, algo siempre es necesario para mantener seguros a los trabajadores.

From transporting, production, storage to processing and distribution, explosions and fires are among the top hazards across oil and gas industry. Explosion-proof certified equipment with classified and T-rated equipment is always necessary to keep workers safe.

Du transport, de la production, du stockage à transformation et distribution, explosions et les incendies comptent parmi les principaux dangers à travers l'industrie du pétrole et du gaz. Antidéflagrant équipement certifié avec classification et Un équipement classé T est toujours nécessaire pour assurer la sécurité des travailleurs.



TITAN ILUMINACION DE SUELO / FLOOR LIGHTING / ÉCLAIRAGE AU SOL

La serie de luces lineales empotradas TITAN es el siguiente nivel de elección para aplicaciones en suelos al aire libre, con una incomparable resistencia al vandalismo, rayos UV, agua, corrosión y deslizamiento, así como una experiencia visual adecuada para una visión directa. Al pavimentarlo en carreteras se ofrece un resultado sin puntos, un paisaje nocturno sin deslumbramiento ni reflejos, bien iluminado y con innumerables posibilidades de presentación aplicable a ambientes de alta temperatura como sauna seca, sauna de vapor, spas... de hasta 95°

The in-ground TITAN linear light series is your next-level choice for outdoor floor applications, featuring the unrivaled resistance to vandalism, UV, water, corrosion, and slipping, as well as the elevated visual experience suitable for a direct view. Paving it on roads, you can anticipate a dot-free, glare-free, and well-lit nightscape presented in countless possibilities. Applicable to high temperature environments such as dry sauna, steam sauna, spas... up to 95°

La série TITAN de lumières linéaires encastrées est le prochain niveau de choix pour les applications de sol extérieur, avec une résistance au vandalisme, aux rayons UV, à l'eau, à la corrosion et au glissement, ainsi qu'une expérience visuelle adaptée à la visualisation directe. Lorsqu'il est pavé sur des routes, on obtient un résultat sans taches, un paysage nocturne sans éblouissement ni reflets, bien éclairé et avec d'innombrables possibilités de présentation.

Applicable aux environnements à haute température tels que sauna sec, sauna à vapeur, spas... jusqu'à 95°



Anima tu piscina y estado de ánimo



Seguridad
UL 676
Aprobado



30m
Longitud
individual



5m
Profundidad



5 años
Garantía



ANTI
Amarillamiento

ANSI
C 78.377

3
SDCM

55°C
-40°C
T Ambiente
Laboral

Ø300mm
Min. Doblar

La serie HYDRA, el neón LED flexible con clasificación IP68, le brinda una libertad sin precedentes en el diseño de iluminación para aplicaciones subacuáticas en interiores y exteriores, con luz en línea continua, múltiples opciones de color, longitud personalizada y dos direcciones de curvatura. Como luminaria subacuática profesional, cuenta con la certificación UL 676 y es resistente al óxido, al cloro y a los rayos UV, testada mediante pruebas exhaustivas.

The HYDRA Series, IP68 rated flexible LED neon, gives you unprecedented freedom in lighting design for indoor and outdoor underwater applications, with continuous line light, multiple color options, custom length and two bend directions. As a professional underwater luminaire, it is UL 676 certified and is rust, chlorine and UV resistant, tested through extensive testing.

La série HYDRA, un néon LED flexible classé IP68, vous offre une liberté sans précédent dans la conception d'éclairage pour les applications sous-marines intérieures et extérieures, avec une ligne lumineuse continue, plusieurs options de couleurs, une longueur personnalisée et deux directions de courbure. En tant que luminaire sous-marin professionnel, il est certifié UL 676 et résiste à la rouille, au chlore et aux UV, testé grâce à des tests approfondis.

HYDRA

Aplicaciones / Applications / Applications

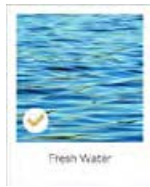

Características del Producto / Product characteristics / Caractéristiques du produit

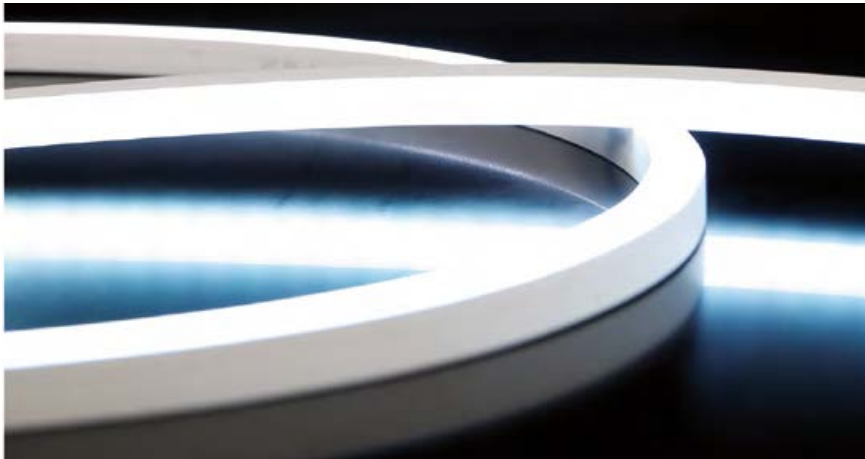

Certificado de seguridad UL 676

Cumple con UL 676, uno de los estándares más estrictos para luminarias y accesorios subacuáticos de seguridad. Totalmente encapsulado en silicona y sellado por el conector moldeado por inyección con cable SJTW resistente a la intemperie.



Longitud uniforme de 30 m.

Se puede conseguir una línea de luz homogénea y suave de hasta 30 m por línea. Opcional en flexión horizontal y vertical para adaptarse a las necesidades de instalación.



5 metros de profundidad

Clasificación IP68, sumergible permanentemente para piscinas, elementos acuáticos, fuentes y más a una profundidad de hasta 5 m.





5 años de garantía

Le brindamos una experiencia de compra sin costes de mantenimiento, garantizada por productos de primera calidad.

Especificaciones / Specifications / Caractéristiques

Light











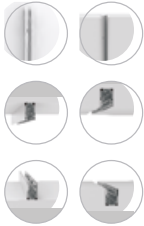

	Color claro	Voltaje Y tipo de circuito	Potencia/m	Lumen/m (3000K)	Mín. Corte Longitud (mm)	Máx. Correr Longitud (metro)
<p>Vertical Bending</p> 		24CC	8W	/	83,5	20
		24CC	6W	280lm	55,6	30
		24CC	9W	420lm	55,6	18
		24CC	12W	565lm	55,6	15
		24CC	15W	700lm	55,6	10
		24CC	12W	/	83,3	15
		24CC	12W	/	83,3	15
		24CC	16,5W	/	83,3	10
		24CC	22W	/	83,3	8
		24CC	10W	/	100	15

B (mono) D (luz dinámica) S (píxeles direccionables) A (RGB) E (RGBW)

Horizontal Bending 	Color claro	Voltaje Y tipo de circuito	Potencia/m	Lumen/m (3000K)	Mín. Corte Longitud (mm)	Máx. Correr Longitud (metro)
		24CC	8W	/	83,5	20
		24CC	6W	280lm	55,6	30
		24CC	9W	420lm	55,6	18
		24CC	12W	565lm	55,6	15
		24CC	15W	700lm	55,6	10
		24CC	12W	/	83,3	15
		24CC	12W	/	83,3	15
		24CC	16,5W	/	83,3	10
		24CC	22W	/	83,3	8
	24CC	10W	/	100	15	

Especificaciones / Specifications / Caractéristiques

- **Conector / Connector / Connecteur** ► **Perfil de montaje / Mounting profile / Profil de montage**

Nombre	Conector de pestillo	Moldeado por inyección de silicona Conector (certificado UL 676)	Moldeado por inyección de silicona Conector (certificado CE)	Perfil de plástico engrosado
Imagen				
Clasificación del IP	IP68 (Profundidad máx. 5 m)	IP68 Máx. 2 m de profundidad)	IP68 (Máx. 2 m de profundidad)	TP/PL
Característica	Montaje en campo Operación conveniente Resistente al óxido	Junta sin costuras Aspecto compacto Certificado UL676 Cable SJTW dedicado	Junta sin costuras Aspecto compacto Certificado CE	35, 500, 1000, 2000
AplicaciónS	Submarina	ubmarina	Submarina	
Tipo de cable	B  18AWG*2 D/S(SPI)  18AWG*3 Solo están disponibles las series D y S en flexión horizontal.	B  18AWG*2 D/S(SPI)  18AWG*3	B  18AWG*2 A  22AWG*3 20AWG*1 D/S(SPI)  18AWG*3 E  22AWG*4 20AWG*1	

Prueba / Proof / Test

Fuente de luz	Fotoelectricidad: choque de alta y baja temperatura (-40~100°C)	JELTA ED-4701 100 105
Accesorio de metal y Perfil de montaje	Resistencia a la intemperie: pulverización de sal	IEC 68-2-11
Accesorio impermeable	Resistente al agua-IPx5 / IPx7 / IPx8	CLARO -definido
Producto terminado	Fotoelectricidad-Choque de alta y baja temperatura-45°C~60°C-silicona	CLARO -definido

Sumergible LED Flex para aguas termales

Elimina tus preocupaciones con un brillo relajante



HYDRA

Descripción general

HYDRA Flexible Light Scrip está diseñado para sumergirse en aguas termales. La carcasa de silicona es de naturaleza estable y es menos probable que tenga una reacción química con los microelementos del agua, y puede permanecer sumergida durante mucho tiempo. El Neon flexible pueden adaptarse a varias formas o incrustarse en el exterior de los jacuzzis para dar formas.

General description

HYDRA Flexible Light Scrip is designed for soaking in hot springs. The casing Silicone is stable in nature and is less likely to have a chemical reaction with microelements in water, and can remain submerged for a long time. The flexible Neon can adapt to various shapes or be embedded in the exterior of hot tubs to create shapes.

Description générale

HYDRA Flexible Light Scrip est conçu pour être trempé dans les sources chaudes. Le boîtier Le silicone est de nature stable et est moins susceptible d'avoir une réaction chimique avec les microéléments présents dans l'eau et peut rester immergé pendant une longue période. Le Neon flexible peut s'adapter à diverses formes ou être intégré à l'extérieur des spas pour créer des formes.

Aplicaciones / Applications / Applications



Características del Producto / Product characteristics / Caractéristiques du produit

☆ Resistencia al agrietamiento

HYDRA LED Flex Linear está recubierto de silicona para resistir mejor la formación de grietas, lo que dificulta la entrada de oligoelementos en el Neon y minimiza los problemas de calidad.

☆ Sumergible

La carcasa de silicona extruida y el conector inyectado de silicona permiten una clasificación de impermeabilidad IP68. El producto cumple con la norma UL676 para luminarias subacuáticas.

☆ Resistencia al calor hasta 45°C

La estructura ofrece una buena gestión térmica y un chip de corriente constante en su interior para evitar el sobrecalentamiento.

☆ Libertad en el diseño

Como uno de los pocos LED Flex Linear diseñados para aguas termales, estas luces sumergibles y resistentes al calor están disponibles en dos direcciones de curvatura, lo que permite una mayor flexibilidad y adaptabilidad a aguas termales de formas irregulares, proporcionando un esquema de iluminación uniforme y opciones personalizadas.

☆ Garantía 3 años

Proporcionamos una garantía de 3 años para ahorrar energía y costes de mantenimiento, garantizada por la calidad superior de los productos.

Especificaciones / Specifications / Caractéristiques

Light

	Color claro	Voltaje Y tipo de circuito	Potencia/m	Lumen/m	Mín. Corte Longitud (mm)	Máx. Correr Longitud (metro)
Vertical Bending 		24CC	6W	350lm (3000K)	55.6	30
		24CC	6W	135lm (2200~5700K)	125	30
		24CC	4.5W	138lm (R+G+B)	83.3	20
		24CC	6W	95lm (3000K)	83.3	20
Horizontal Bending 		24CC	6W	260lm (3000K)	55.6	30
		24CC	6W	135lm	125	30
		24CC	4.5W	128lm (R+G+B)	83.3	20
		24CC	6W		83.3	20

Especificaciones / Specifications / Caractéristiques

Conector / Connector / Connecteur

Nombre	Conector de pestillo	Conector moldeado por inyección de silicona (UL676)	Conector moldeado por inyección de silicona
Imagen			
Clasificación del IP	IP68	IP68	IP68
Característica	Montaje en campo Operación conveniente Resistente al óxido	Junta sin costuras Aspecto compacto Certificado UL676 Cable SJTW dedicado	Junta sin costuras Aspecto compacto
Application	Submarino	Submarino	Submarino
Tipo de cable	<p>B  18AWG*2</p> <p>D  18AWG*3</p> <p>disponible en curvatura horizontal sólo para la serie D</p>	<p>B  18AWG*2</p> <p>D  18AWG*3</p>	<p>B  18AWG*2</p> <p>A  22AWG*3 20AWG*1</p> <p>D  18AWG*3</p> <p>E  22AWG*4 20AWG*1</p>

Perfil de montaje / Mounting profile / Profil de montage

Nombre	Código del objeto	Longitud (mm)	Aplicable a
Perfil de plástico engrosado 	TP/PL	35, 500, 1000, 2000	

Prueba / Proof / Test

Fuente de luz	Fotoelectricidad: choque de alta y baja temperatura (-40~100°C)	JELTA ED-4701 100 105
Accesorio metálico y perfil de montaje.	Resistencia a la intemperie: pulverización de sal	IEC 68-2-11
Accesorio impermeable	Resistente al agua-IPX5 / IPx7 / IPx8	CLARO -definido
Producto terminado	Fotoelectricidad-Alta y baja temperaturachoque-45°C~60°C-silicona	CLARO -definido

Sauna LED flexible Luz Lineal

Silicona

VOLCAN

Ambiente Laboral
Temperatura
Work Environment
Temperature
Ambiance de travail
Température

Max.
95°C

Ambiente
Relativo Humedad
Atmosphere
Relative Humidity
Atmosphère
Humidité relative

Max.
100%

Lúmenes
Producción
Lumens
Production
Lumens
Production

Max.
450
lm/m

Garantía
Warranty
Garantie

3
years

Productos de silicona disponibles Silicone products available Produits en silicone disponibles	VOLCAN
Clasificación del IP IP Rating Indice IP	IP67
Potencia nominal Rated power Puissance nominale	≤6W/m
Aplicable a Applicable to Applicable à	Alta temperatura y humedad ambientes como sauna seca, Sauna húmeda, baño de vapor, SPA, etc. High temperature and humidity environments such as dry sauna, wet sauna, steam bath, SPA, etc. Environnements à haute température et humidité tels que sauna sec, sauna humide, bain de vapeur, SPA, etc.

Precauciones de instalación

1. Mantenga al menos 80cm. de distancia de la salida de vapor o del área de la fuente de calor.
2. No lo coloque en un espacio cerrado, ya que se necesita circulación de aire.
3. No toque los componentes metálicos directamente para evitar quemaduras.

Installation Precautions

1. Keep at least 80cm. away from the steam outlet or heat source area.
2. Do not place it in a closed space, as air circulation is needed.
3. Do not touch the metal components directly to avoid burns.

Précautions d'installation

1. Gardez au moins 80 cm. loin de la sortie de vapeur ou de la zone de source de chaleur.
2. Ne le placez pas dans un espace fermé, car une circulation d'air est nécessaire.
3. Ne touchez pas directement les composants métalliques pour éviter les brûlures.

Características del Producto / Product characteristics / Caractéristiques du produit

☆ Seguro y confiable

Adopta un diseño de corriente constante incorporado para controlar el aumento de temperatura, sin necesidad de protección adicional contra altas temperaturas.

☆ Instalación versátil

Luz directa o indirecta, flexible horizontal o verticalmente.

☆ Listo para la instalación

Conector ensamblado en fábrica, integrado automáticamente en el producto.

☆ Medidas estándar o personalizadas

Máx. 10m por línea, y mín. incremento de 55 mm.

☆ Incluso con múltiples empalmes de LED Flex



Proporcionamos una garantía de 3 años para ahorrar energía y costes de mantenimiento, garantizada por la calidad superior de los productos.

☆ Coste mucho menor, tanto de mantenimiento como para el usuario



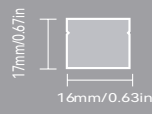
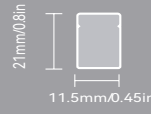

Comparado con la iluminación de Sauna tradicional, presentamos una solución superior en eficiencia, durabilidad y colocación.

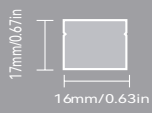

● Monocromo / Monochrome / Monochromes

Dimensión				
Dirección de plegado	HB/VB	HB	HB	VB
Voltaje (V)	24	24	24	24
Corriente (mA/m)	250	250	250	250 (166.7, por R,A)
Potencia (W/m)	6	6	6	6 (4, por R,A)
Tipo de circuito	CC	CC	CC	CC
Cantidad de LED/m	108	72	72	36
Cantidad de LED/unidad	6 (9, por R,A)	6 (9, por R,A)	6 (9, por R,A)	6 (9, por R,A)
Unidad/m	18 (12, por R,A)	12 (8, por R,A)	12 (8, por R,A)	6 (4, por R,A)
Mín. Longitud de corte (mm)	55.6 (83.3, por R,A)	83.3 (125, por R,A)	83.3 (125, por R,A)	166.7 (250, por R,A)
Mín. Diámetro de plegado (mm)	300	120	120	50
Máx. Longitud de carrera (mm)	10,000	10,000	10,000	10,000

● RGB / RGB / RVB

Dimensión				
Dirección de plegado	HB/VB	HB	HB	VB
Voltaje (V)	24	24	24	24
Corriente (mA/m)	187.5	150	150	150
Potencia (W/m)	4.5	3.6	3.6	3.6
Tipo de circuito	CC	CC	CC	CC
Cantidad de LED/m	84	60	60	60
Cantidad de LED/unidad	7	6	6	6
Unidad/m	12	10	10	10
Mín. Longitud de corte (mm)	83.3	100	100	100
Mín. Diámetro de plegado (mm)	300	120	120	50
Máx. Longitud de carrera (mm)	10,000	10,000	10,000	10,000

Especificaciones / Specifications / Caractéristiques

Conector / Connector / Connecteur

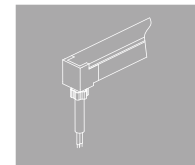
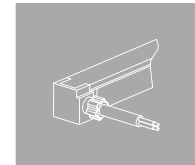
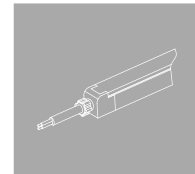

Perfil de montaje / Mounting profile / Profil de montage

Aluminio Profile		A/PL	35, 500, 1000, 2000	
Brida Aluminio Profile		FA/PL	35, 500, 1000, 2000	
Serrado Aluminio Profile		SA/PL	20, 500, 1000, 2000	
SerraFlange Serrado Ted Aluminio Profile		FSA/PL	20, 500, 1000, 2000	
Serrado flexible Aluminio Profile		BSA/PL	500, 1000	
Perfil de acero Inoxidable Profile		SS/PL	35	

Diseñado para Ambientes Explosivos y Peligrosos

Descripción general

Desde el transporte, la producción, el almacenamiento hasta el procesamiento y la distribución, las explosiones y los incendios se encuentran entre los principales peligros en toda la industria de petróleo y gas. Siempre es necesario trabajar con equipamiento certificado con clasificación T a prueba de explosiones para mantener seguros a los trabajadores. La luz LED de NEON flexible DORUK Ex se ha fabricado para hacer frente a condiciones extremas en lugares potencialmente explosivos donde el acceso es difícil y problemático. Estas luces lineales flexibles están aprobadas con los certificados ATEX y iECEx, con los más altos estándares de seguridad y mostrando fuertes compromisos con los requisitos HSE. DORUK Ex es perfecto para resaltar la contorno de las escaleras y pasamanos de tanques de almacenamiento, buques de GNL o crear una advertencia de zona de luz sobre plataformas o equipos para trabajos peligrosos, para así mantener seguros a los trabajadores. Su increíble flexibilidad permite que la luz ilumine lugares de difícil acceso para las luminarias tradicionales, que suelen también iluminar muy poco debido a ese difícil acceso. Estas luces encajan perfectamente también como iluminación de apoyo en espacios más pequeños como salas de máquinas plegadoras, salas de mandos, escalera de incendios o camión cisterna. Se encuentran disponibles opciones en RGB y regulables. Las luces LED flexibles son energéticamente eficientes y no deslumbran, ayudando a contribuir a un entorno solidario y un lugar de trabajo seguro.

General description

From transportation, production, storage to processing and distribution, explosions and fires are among the top hazards throughout the oil and gas industry. It is always necessary to work with certified T-rated explosion-proof equipment to keep workers safe. The DORUK Ex flexible NEON LED light has been manufactured to cope with extreme conditions in potentially explosive locations where access is difficult and problematic. These flexible linear lights are approved with ATEX and iECEx certificates, meeting the highest safety standards and showing strong commitments to HSE requirements. DORUK Ex is perfect for highlighting the contours of stairs and handrails on storage tanks, LNG vessels or creating a light zone warning on platforms or hazardous work equipment to keep workers safe. Its incredible flexibility allows the light to illuminate places that are difficult to access for traditional luminaires, which also tend to illuminate very little due to difficult access. These lights also fit perfectly as supporting lighting in smaller spaces such as folding machine rooms, control rooms, fire escapes or tank trucks. RGB and dimmable options are available. Flexible LED lights are energy efficient and glare-free, helping to contribute to a supportive environment and safe workplace.

Description générale

Du transport à la production, en passant par le stockage, la transformation et la distribution, les explosions et les incendies comptent parmi les principaux dangers dans l'industrie pétrolière et gazière. Il est toujours nécessaire de travailler avec des équipements antidéflagrants certifiés T pour assurer la sécurité des travailleurs. La lampe LED NEON flexible DORUK Ex a été fabriquée pour faire face à des conditions extrêmes dans des endroits potentiellement explosifs où l'accès est difficile et problématique. Ces éclairages linéaires flexibles sont approuvés par les certificats ATEX et iECEx, répondant aux normes de sécurité les plus élevées et démontrant un engagement ferme envers les exigences HSE. DORUK Ex est parfait pour mettre en valeur les contours des escaliers et des mains courantes sur les réservoirs de stockage, les navires de GNL ou pour créer une zone d'avertissement lumineuse sur les plates-formes ou les équipements de travail dangereux pour assurer la sécurité des travailleurs. Son incroyable flexibilité permet à la lumière d'éclairer des endroits difficilement accessibles pour les luminaires traditionnels, qui ont également tendance à éclairer très peu en raison de la difficulté d'accès. Ces luminaires conviennent également parfaitement comme éclairage d'appoint dans des espaces plus petits tels que les salles de machines pliantes, les salles de contrôle, les issues de secours ou les camions-citernes. Des options RVB et dimmables sont disponibles. Les lumières LED flexibles sont économes en énergie et non éblouissantes, contribuant ainsi à contribuer à un environnement favorable et à un lieu de travail sûr.



Ex LED

Flex Linear Light



Protección IP67



1000 lm/m



>50000h de vida útil



Ambiente de trabajo
Temperatura



Longitud



Garantía de 5 años

DORUK

Características del Producto / Product characteristics / Caractéristiques du produit

☆ Flexibilidad

Capaz de fijarse a una pared o viga, o encajar perfectamente en huecos o suspensión.

☆ Durabilidad

La carcasa de silicona puede soportar Más de 100 kg de fuerza de tracción sin rotura.



☆ 30M línea continua

Ideal para escenarios de largo alcance incluidos túneles y minas de carbón.

☆ Eficacia y Eficiencia

El producto ofrece una eficiencia luminosa de hasta 83 lm/W y una vida útil de 50.000 horas.

☆ Seguridad Inherente

La encapsulación de silicona aísla los gases explosivos y el polvo, y minimiza los riesgos de explosión; El bajo voltaje de 24 V reduce los riesgos de sufrir una descarga eléctrica y garantiza la seguridad de las instalaciones de iluminación exterior

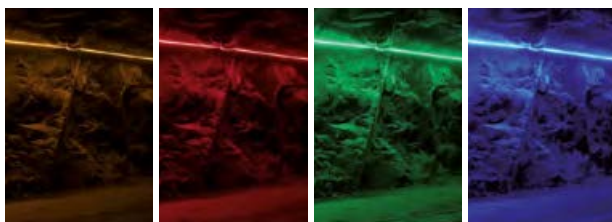
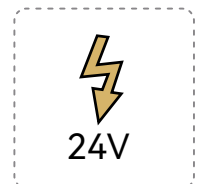
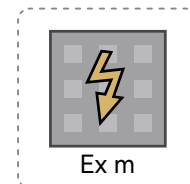

☆ Opciones RGB

Hay varias opciones de colores disponibles, incluidos blanco, rojo, verde, azul, ámbar o RGB. La luz puede parpadear como señal luminosa, permitiendo a los trabajadores implementar monitoreo de seguridad y advertencia instantánea.

Dimensiones / Dimensions / Dimensions

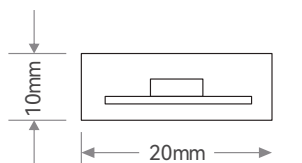
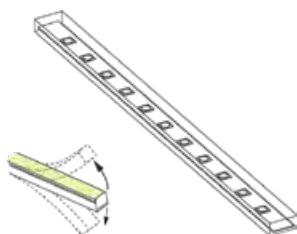

Nota: A menos que se especifique lo contrario, la tolerancia de las dimensiones es $\pm 0,3$ mm.

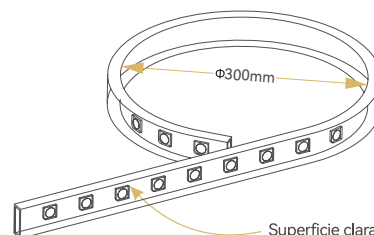

Parametros basicos / Basic parameters / Paramètres de base

Voltage	LED QTY/m	Lumen/m	Clasificado potencia/m	Otros LED Opciones de cantidad	Color
AC48V DC48V	84 84	>900lm >1000lm	12w 12w	56, 28 56, 28	6500K, rojo, verde, ámbar 6500K, rojo, verde, ámbar
AC36V DC36V	88 88	>900lm >1000lm	12w 12w	66, 44, 22 66, 44, 22	6500K, rojo, verde, ámbar 6500K, rojo, verde, ámbar
AC24V DC24V	84 84	>900lm >1000lm	12w 12w	56, 28 56, 28	6500K, rojo, verde, ámbar 6500K, rojo, verde, ámbar
DC24v	42		3w	28, 14	R/G/A/RG/RGA

Parametros basicos / Injection molded connector / Connecteur moulé par injection

El conector integrado moldeado por inyección de silicona líquida es hermético Y IP67, lo que garantiza un uso duradero en exteriores agrietarse y eliminar los riesgos de cortocircuito causados por el agua.

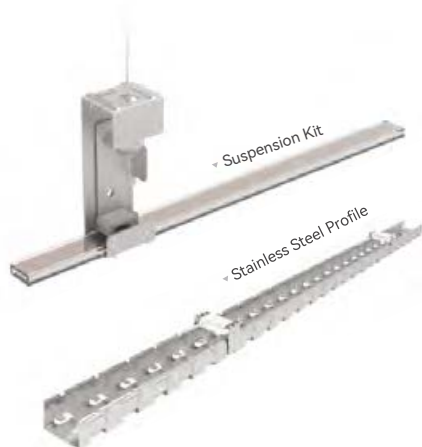

Perfil de montaje / Mounting profile / Profil de montage

Kit de suspensión

- ☆ Fácil de montar y desmontar
- ☆ Capaz de mantener el objeto en su lugar y soportar vibraciones
- ☆ Acero inoxidable resistente al óxido
- ☆ Altura ajustable
- ☆ El diseño hueco no afecta la salida de luz.

Perfil de acero inoxidable

- ☆ Montaje rápido
- ☆ Adaptable a cualquier montura, superficie o ambiente
- ☆ El diseño de la correa y el clip ayuda a asegurar el Neon en su lugar sin sacrificar la eficiencia lumínica.

Entornos Aplicables

Applicable Environments

Environnements applicables



- I M2 Ex ma op is I Mb;
(Grupo I metano/polo de carbón, M2 - operación donde existe riesgo de explosión ocasional, Ex ma - nivel muy alto de encapsulación de protección)
- I M2 Ex mb op is I Mb;
(Grupo I metano/polo de carbón, M2 - operación donde existe riesgo de explosión ocasional, Ex mb - alto nivel de encapsulación de protección)
- II 2G Ex mb op is IICT6 Gb;
(Gases del grupo II, 2G - Zona 1,2, Ex mb - encapsulación de alto nivel de protección, Gas grupo IIC hidrógeno);
- II 2D Ex mb op is IIIC T80°C Db;
(Grupo II - polos, 2D - Zona 21,22, Ex mb - alto nivel de protección mediante encapsulación, grupo IIIC - polvo metálico combustible)

Abrá Nuevos Caminos con
Luces Empotradas Resistentes

TITAN



10000 kg/0,5 m
Carga estática



Protección IP67



Protección IK10



Antideslizante



Ambiente de trabajo
Temperatura



Garantía de 5 años



Soluciones de iluminación de suelo



La serie de luces lineales empotradas TITAN es su opción al siguiente nivel para aplicaciones de suelos en exteriores, ya que presenta una resistencia inigualable al vandalismo, los rayos UV, el agua, la corrosión y el deslizamiento, así como una experiencia visual elevada sin deslumbramiento. Al pavimentarlo en carreteras, podemos anticipar un paisaje nocturno sin puntos, sin deslumbramientos y bien iluminado, presentado en innumerables posibilidades. Construido con un diseño estructural visionario, con la tira de LED con clasificación IP68 alojada en una carcasa metálica sólida, distintivamente sellada por un difusor de silicona reforzado, todo se combina para ser una fusión de robustez e impermeabilidad. Es fácil aplicarlo en pasarelas, entradas de vehículos, plazas, estacionamientos, paisajes, fuentes y más, donde con frecuencia sufren el impacto de tacones altos y vehículos, o pueden recibir salpicaduras o remojarse en agua. Además del color estático en blanco o RGB, se pueden lograr efectos de iluminación diversificados, como regulación o cambio de color. También está listo para una extensión ilimitada de la longitud de la luz simplemente conectando conectores macho y hembra sin zonas oscuras en la superficie emisora. La iluminación uniforme y continua hacen que la serie empotrable se convierta en la mejor solución para luces decorativas y de señalización en el suelo.

The TITAN series of recessed linear lights is your next-level choice for outdoor floor applications, featuring unmatched vandal, UV, water, corrosion and slip resistance, as well as an elevated, glare-free viewing experience. . By paving it on roads, we can anticipate a spotless, glare-free and well-lit night landscape, presented in countless possibilities. Built with a visionary structural design, with the IP68 rated LED strip housed in a solid metal casing, distinctively sealed by a reinforced silicone diffuser, it all combines to be a fusion of robustness and waterproofing. It's easy to apply to walkways, driveways, plazas, parking lots, landscapes, fountains and more, where they often suffer the impact of high heels and vehicles, or may be splashed or soaked in water. In addition to static white or RGB color, diversified lighting effects such as dimming or color changing can be achieved. It is also ready for unlimited extension of light length by simply connecting male and female connectors without dark areas on the emitting surface. The uniform and continuous lighting makes the recessed series the best solution for decorative and signaling lights on the ground.

La série TITAN de luminaires linéaires encastrés est votre choix de niveau supérieur pour les applications de revêtement de sol extérieur, offrant une résistance inégalée au vandalisme, aux UV, à l'eau, à la corrosion et au glissement, ainsi qu'une expérience visuelle élevée et sans éblouissement. En le pavant sur les routes, nous pouvons anticiper un paysage nocturne impeccable, sans éblouissement et bien éclairé, présenté dans d'innombrables possibilités. Construit avec une conception structurelle visionnaire, avec la bande LED classée IP68 logée dans un boîtier métallique solide, distinctement scellé par un diffuseur en silicone renforcé, tout cela se combine pour être une fusion de robustesse et d'étanchéité. Il est facile à appliquer sur les allées, les places, les parkings, les paysages, les fontaines et plus encore, où ils subissent souvent l'impact des talons hauts et des véhicules, ou peuvent être éclaboussés ou trempés dans l'eau. En plus du blanc statique ou de la couleur RVB, des effets d'éclairage diversifiés tels que la gradation ou le changement de couleur peuvent être obtenus. Il est également prêt pour une extension illimitée de la longueur de la lumière en connectant simplement des connecteurs mâles et femelles sans zones sombres sur la surface émettrice. L'éclairage uniforme et continu fait de la série encastrée la meilleure solution pour l'éclairage décoratif et de signalisation au sol.

Características del Producto / Product characteristics / Caractéristiques du produit

☆ Nivel de paso de vehículos

Se ofrece la máxima seguridad con una carga estática de hasta 10.000 kg/0,5 m, al menos 30 veces mayor que la que puede soportar cuando pasa un sedán, como lo demuestran pruebas de laboratorio y pruebas de simulación a largo plazo. No se producirán daños ni deformaciones en la luz empotrada.

☆ Iluminación continua perfecta

Se puede conseguir una línea de luz ininterrumpida uniendo infinitamente luminarias empotradas en el suelo, conectando los cables desde el lateral o desde abajo, y así no se percibe ninguna zona oscura, incluso mirando de cerca.

☆ Alta resistencia a la corrosión

Opcional en la carcasa, hecha de acero inoxidable 316L de grado marino, de hasta 3 mm de espesor para entornos que requieren alta resistencia a la corrosión o a altas temperaturas. Hablamos de la carcasa, hecha de acero inoxidable 316L de grado marino, de hasta 3 mm de espesor para entornos que requieren alta resistencia a la corrosión o a altas temperaturas.





☆ Estanqueidad demostrada

La estanqueidad se potencia en el interior de la carcasa, ya que tiene una tira de LED completamente encapsulada integrada con un conector moldeado por inyección IP68, conectado en serie con conectores macho y hembra IP67. No sólo se aprovecha su estanqueidad, sino que se beneficia de su diseño de drenaje en la parte inferior para evitar la acumulación de agua a largo plazo.

☆ Mantenimiento conveniente

La estructura desmontable permite la limpieza, resolución de problemas y otros trabajos de mantenimiento en la tira de LED interior muy fácilmente, preservando el piso de montaje y los accesorios empotrados.



Tipo			
Color claro			
Material	Acero inoxidable 316 (3 mm de espesor)	Acero inoxidable 316 (2 mm de espesor)	Aleación de aluminio 6063
Carga estática	10000kg/0.5m	8000kg/0.5m	1000kg/0.5m
Ancho x Alto	85mm x 100mm	85mm x 100mm	80mm x 69mm
Ocultar cableado	Disponible	Disponible	Disponible
Adaptabilidad	Conducir o pisotear	Paseo ligero o estampar	Sello solo
Clasificación del IP	IP67	IP67	IP67
Longitud estándar	204 mm, 504 mm, 1004 mm	204mm, 504mm, 1004mm	204mm, 504mm, 1004m

Prueba / Proof / Test

Serie	Pruebas	Datos de prueba	Estándares
1	Resistencia a la carga estática	10000kg *	IEC60598-2-13
2	Resistencia a la carga de torsión	50Nm *	IEC60598-2-13
3	Resistencia a la carga de corte	5KN *	IEC60598-2-13
4	Clasificación de protección contra impactos	IK10(20J)	IEC62262, IEC60068-2-75
5	Spray de sal	Level 10	IEC60068-2-11, ISO10289
6	Estanqueidad al agua	IPX8	EN60598-1: 2015+A1: 2018 Cláusulas 9.2.2 y 9.2.8

*Nota: datos para el tipo acero inoxidable, espesor 3mm.

Tipo / Guy / Type

1 & 2 Acero inoxidable / Stainless steel / Acier inoxidable

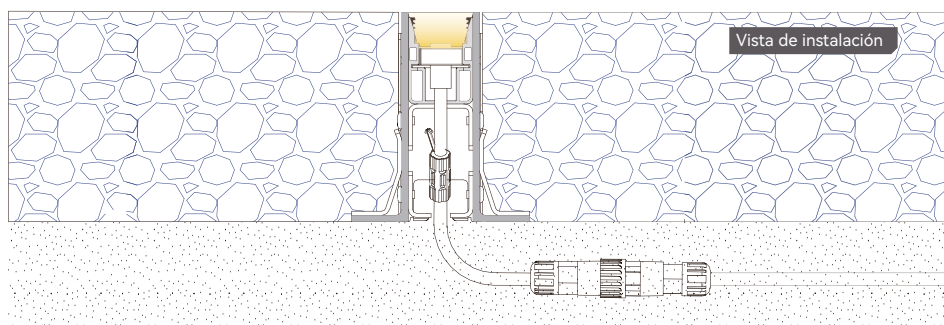

3 Aluminio / Aluminum / Aluminium

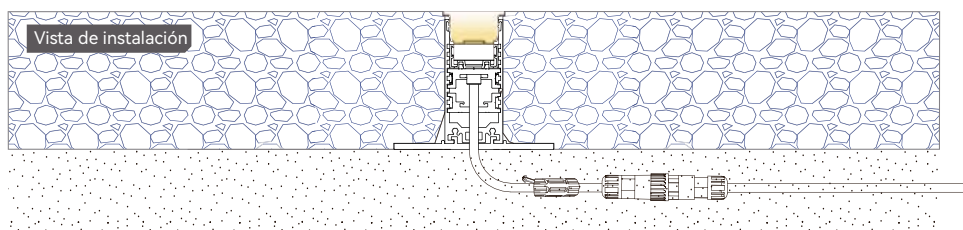

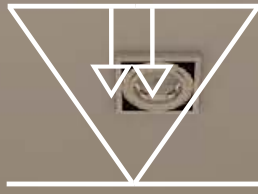

LYOPRO

LED PROFILE

Perfilería de aluminio que actúa como disipador de calor de nuestras tiras led. Con más de 70 modelos en stock, en diferentes acabados, nos facilitan multitud de soluciones para poder acometer cualquier proyecto.

Aluminum profiles that act as a heat sink for our led strips. With more than 70 models in stock, in different finishes, they provide us with a multitude of solutions to be able to undertake any project.

Profilés en aluminium qui agissent comme dissipateur thermique pour nos rubans led. Avec plus de 70 modèles en stock, dans différentes finitions, ils nous offrent une multitude de solutions pour pouvoir entreprendre n'importe quel projet.

Perfilería
Profiles
Profilés



LYOPRO

LED PROFILE



Perfilería de superficie
Surface profiling
Profilage de surface

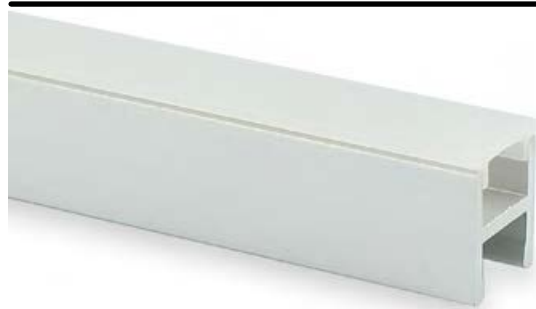

Perfil fabricado con aluminio extrusionado y anodizado. Diseñado como disipador de tiras de LED.

Profile made of extruded and anodized aluminium. Designed as a heatsink for LED strips.

Profil fabriqué en aluminium extrudé et anodisé. Conçu comme dissipateur thermique pour les bandes LED.

IP20

Max. w/m
50 W

AL
6063

Cut
to
Size

Plata 2m
Silver 2m
Argent 2m

Ref.: **85240**
PVP: 8,95€

Plata 3m
Silver 3m
Argent 3m

Ref.: **85241**
PVP: 12,95€

* Coste de envío de perfil de 3m a consultar en condiciones generales de venta

* Shipping cost of 3m profile to consult in general conditions of sale

* Frais de port du profil 3m à consulter dans les conditions générales de vente

Escala / Scale / Échelle 1:1

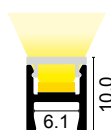
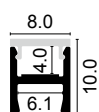

Características técnicas / Technical data / Caractéristiques techniques

Potencia disipada / Power dissipation / Dissipation de puissance	Máx 50 W/M
Aleación de aluminio / Aluminium alloy / Puissance de Roullis	AL 6063
Longitud / Length / Longueur	2 M - 3 M
IP	20

Difusores / Diffusers / Diffuseurs



Referencia Reference Référence	Color Color Couleur	Medida Measure Étendue	PVP
85606	Opal / Opal / Opale	2m	5,95€
85607	Opal / Opal / Opale	3m	8,95€

Tapas / Caps / Tapas



Referencia Reference Référence	Color Color Couleur	PVP
85245	Plata / Silver / Argent	2,15€

Grapas / Staples / Agrafes



Referencia Reference Référence	Color Color Couleur	PVP
85246	Aluminio / Aluminium / Aluminium	1,25€





Perfil fabricado con aluminio extrusionado y anodizado. Diseñado como disipador de tiras de LED.

Profile made of extruded and anodized aluminium. Designed as a heatsink for LED strips.

Profil fabriqué en aluminium extrudé et anodisé. Conçu comme dissipateur thermique pour les bandes LED.

IP20

Max. w/m
50 W

AL
6063

Cut
to
Size

Plata 2m
Silver 2m
Argent 2m

Ref.: **85250**
PVP: 7,95€

Blanco 2m
White 2m
Blanc 2m

Ref.: **85251**
PVP: 8,95€

Escala / Scale / Échelle 1:1



Características técnicas / Technical data / Caractéristiques techniques

Potencia disipada / Power dissipation / Dissipation de puissance	Máx 50 W/M
Aleación de aluminio / Aluminium alloy / Puissance de Roullis	AL 6063
Longitud / Length / Longueur	2 M
IP	20

Difusores / Diffusers / Diffuseurs



Referencia Reference Référence	Color Color Couleur	Medida Measure Étendue	PVP
85606	Opal / Opal / Opale	2m	5,95€

Tapas / Caps / Tapas



Referencia Reference Référence	Color Color Couleur	PVP
85245	Silicona / Silicone / Silicone	2,15€

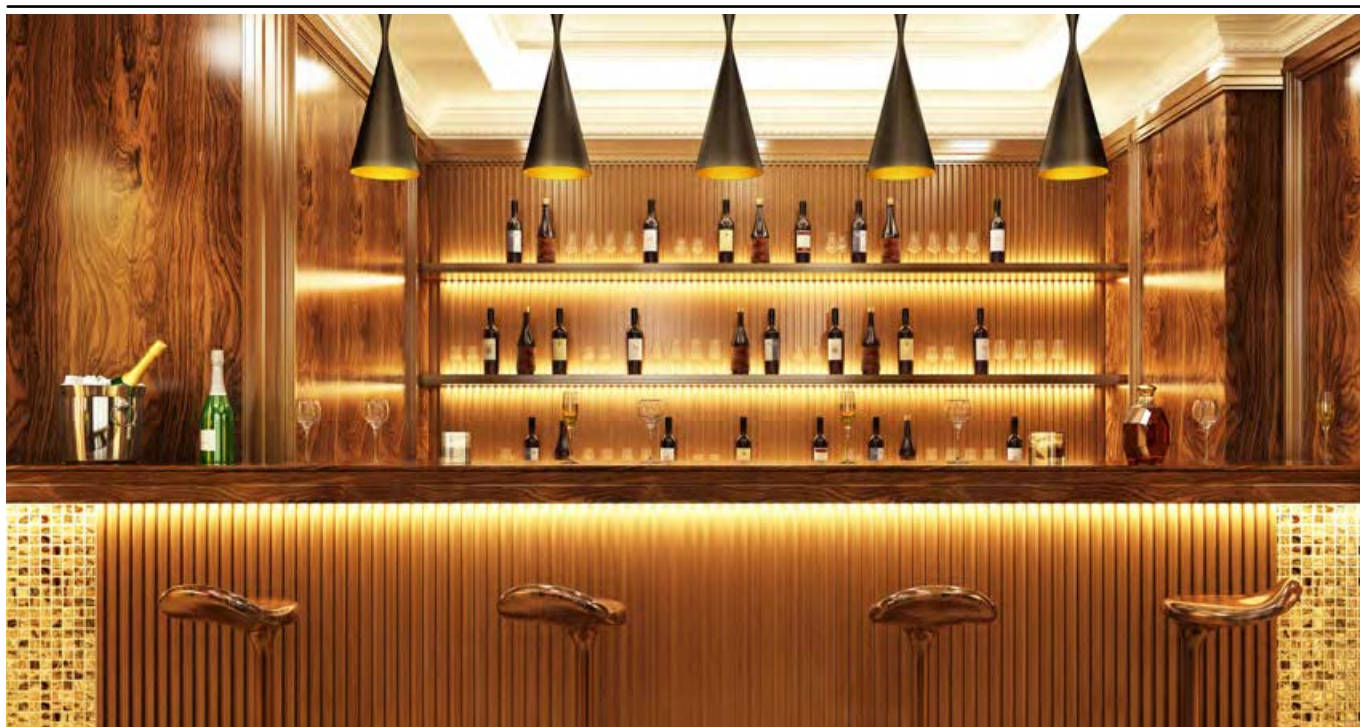



Perfil fabricado con aluminio extrusionado y anodizado. Diseñado como disipador de tiras de LED.

Profile made of extruded and anodized aluminium. Designed as a heatsink for LED strips.

Profil fabriqué en aluminium extrudé et anodisé. Conçu comme dissipateur thermique pour les bandes LED.

IP20

Max. w/m
50 W

AL
6063

Cut
to
Size

●
Plata 2m
Silver 2m
Argent 2m
Ref.: **85270**
PVP: 10,95€

○
Blanco 2m
White 2m
Blanc 2m
Ref.: **85271**
PVP: 11,25€

Escala / Scale / Échelle 1:1

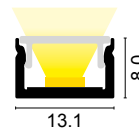
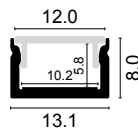

Características técnicas / Technical data / Caractéristiques techniques

Potencia disipada / Power dissipation / Dissipation de puissance	Máx 50 W/M
Aleación de aluminio / Aluminium alloy / Puissance de Roulis	AL 6063
Longitud / Length / Longueur	2 M
IP	20

Difusores / Diffusers / Diffuseurs



Referencia Reference Référence	Color Color Couleur	Medida Measure Étendue	PVP
85638	Opal / Opal / Opale	2m	8,95€

Grapas / Staples / Agrafes



Referencia Reference Référence	Color Color Couleur	PVP
85285	Aluminio / Aluminium / Aluminium	1,10€

Tapas / Caps / Tapas



Referencia Reference Référence	Color Color Couleur	PVP
85279	Plata / Silver / Argent	1,10€
85281	Blanco / White / Blanc	1,30€



Referencia Reference Référence	Color Color Couleur	PVP
85278	Plata / Silver / Argent	1,10€
85280	Blanco / White / Blanc	1,30€

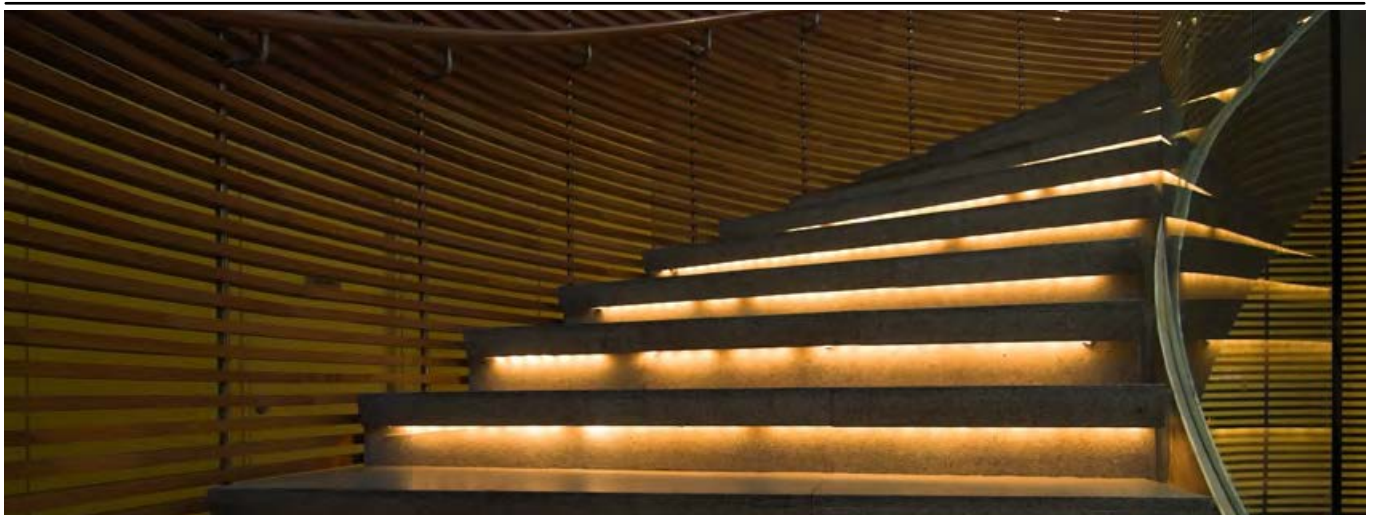



Perfil fabricado con aluminio extrusionado y anodizado. Diseñado como disipador de tiras de LED.

Profile made of extruded and anodized aluminium. Designed as a heatsink for LED strips.

Profil fabriqué en aluminium extrudé et anodisé. Conçu comme dissipateur thermique pour les bandes LED.

IP20

Max. w/m
50 W

AL
6063

Cut
to
Size

Plata 2,02m
Silver 2,02m
Argent 2,02m

Ref.: **86100**
PVP: 9,95€

Blanco 2,02m
White 2,02m
Blanc 2,02m

Ref.: **86101**
PVP: 12,45€

Negro 2,02m
Black 2,02m
Noir 2,02m

Ref.: **86102**
PVP: 12,45€

Escala / Scale / Échelle 1:1

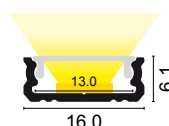
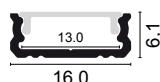



Características técnicas / Technical data / Caractéristiques techniques

Potencia disipada / Power dissipation / Dissipation de puissance	Máx 50 W/M
Aleación de aluminio / Aluminium alloy / Puissance de Roullis	AL 6063
Longitud / Length / Longueur	2,02 M
IP	20

Difusores / Diffusers / Diffuseurs



Referencia Reference Référence	Color Color Couleur	Medida Measure Étendue	PVP
86090	Opal / Opal / Opale	2,02m	5,95€
86091	Opal / Opal / Opale	Al corte 	3,45€ / M
86092	Negro / Black / Noir	2,02m	6,95€
86093	Negro / Black / Noir	Al corte 	4,45€ / M

Tapas / Caps / Tapas



Referencia Reference Référence	Color Color Couleur	PVP
86104	Plata / Silver / Argent	
86106	Blanco / White / Blanc	0,85€
86108	Negro / Black / Noir	



Referencia Reference Référence	Color Color Couleur	PVP
86103	Plata / Silver / Argent	
86105	Blanco / White / Blanc	0,85€
86107	Negro / Black / Noir	

Grapas / Staples / Agrafes



Referencia Reference Référence	Color Color Couleur	PVP
86109	Aluminio / Aluminium / Aluminium	0,70€
86129	Transparente / Transparent / Transparent	0,90€

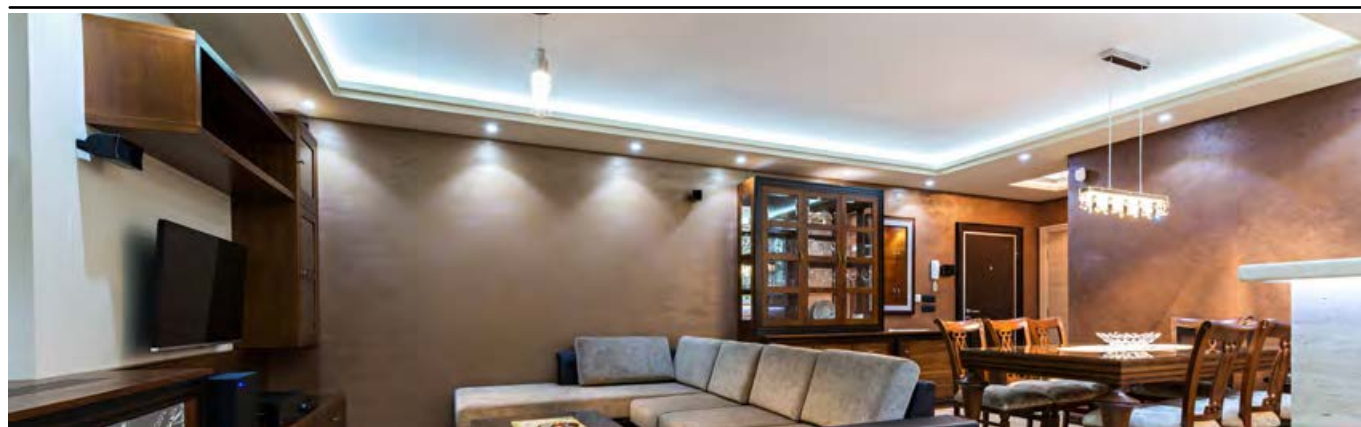



Perfil fabricado con aluminio extrusionado y anodizado. Diseñado como disipador de tiras de LED.

Profile made of extruded and anodized aluminium. Designed as a heatsink for LED strips.

Profil fabriqué en aluminium extrudé et anodisé. Conçu comme dissipateur thermique pour les bandes LED.

IP20

Max. w/m
50 W

AL
6063

Cut
to
Size



Plata 2m
Silver 2m
Argent 2m

Ref.: **83050**
PVP: 10,95€



Blanco 2m
White 2m
Blanc 2m

Ref.: **83051**
PVP: 11,50€



Negro 2m
Black 2m
Noir 2m

Ref.: **83052**
PVP: 11,50€

Escala / Scale / Échelle 1:1

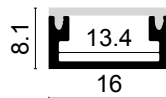



Características técnicas / Technical data / Caractéristiques techniques

Potencia disipada / Power dissipation / Dissipation de puissance	Máx 50 W/M
Aleación de aluminio / Aluminium alloy / Puissance de Roulis	AL 6063
Longitud / Length / Longueur	2 M
IP	20

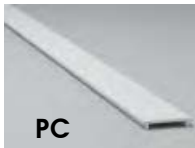
Difusores / Diffusers / Diffuseurs



Referencia Reference Référence	Color Color Couleur	Medida Measure Etendue	PVP
83059-PN	Opal / Opal / Opale	2m	7,95€
83059-B	Opal / Opal / Opale	2m	7,95€
83065	Opal / Opal / Opale	Al corte 	4,95€/M
83063	Negro / Black / Noir	2m	8,95€
83066	Negro / Black / Noir	Al corte 	5,95€/M

Tapas / Caps / Tapas



Referencia Reference Référence	Color Color Couleur	PVP
83054	Plata / Silver / Argent	
83056	Blanco / White / Blanc	0,50€
83058	Negro / Black / Noir	



Referencia Reference Référence	Color Color Couleur	PVP
83053	Plata / Silver / Argent	
83055	Blanco / White / Blanc	0,50€
83057	Negro / Black / Noir	

Grapas / Staples / Agrafes



Referencia Reference Référence	Color Color Couleur	PVP
83062	Aluminio / Aluminium / Aluminium	0,80€



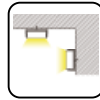

Perfil fabricado con aluminio extrusionado y anodizado. Diseñado como disipador de tiras de LED.

Profile made of extruded and anodized aluminium. Designed as a heatsink for LED strips.

Profil fabriqué en aluminium extrudé et anodisé.

Conçu comme dissipateur thermique pour les bandes LED.

IP20

Max. w/m
50 W

AL
6063

Cut
to
Size

				
Plata 2m Silver 2m Argent 2m	Plata 3m Silver 3m Argent 3m	Blanco 2m White 2m Blanc 2m	Blanco 3m White 3m Blanc 3m	Negro 2m Silver 2m Argent 2m

Ref.: 85160	Ref.: 85195	Ref.: 85165	Ref.: 85196	Ref.: 85190
PVP: 11,95€	PVP: 17,95€	PVP: 12,50€	PVP: 18,95€	PVP: 13,25€

* Coste de envío de perfil de 3m a consultar en condiciones generales de venta

* Shipping cost of 3m profile to consult in general conditions of sale

* Frais de port du profil 3m à consulter dans les conditions générales de vente

Escala / Scale / Échelle 1:1

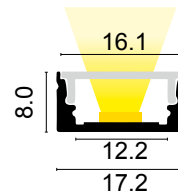
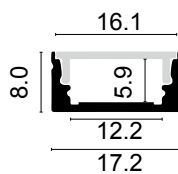

Características técnicas / Technical data / Caractéristiques techniques

Potencia disipada / Power dissipation / Dissipation de puissance	Máx 50 W/M
Aleación de aluminio / Aluminium alloy / Puissance de Roulis	AL 6063
Longitud / Length / Longueur	2 M - 3 M
IP	20

Difusores / Diffusers / Diffuseurs



Referencia Referenc Référence	Color Color Couleur	Medida Measure Etendue	PVP
85161	Opal / Opal / Opale	2m	7,95€
85193	Negro / Black / Noir	2m	11,95€
85198	Opal / Opal / Opale	3m	10,45€

Tapas / Caps / Tapas



Referencia Referenc Référence	Color Color Couleur	PVP
85162	Plata / Silver / Argent	0,75€
85166	Blanco / White / Blanc	1,05€
85191	Negro / Black / Noir	1,05€

Grapas / Staples / Agrafes



Referencia Referenc Référence	Color Color Couleur	PVP
85164	Aluminio / Aluminium / Aluminium	0,95€
85203	Plastico / Plastic / Plastique	0,95€
85204	Plastico 90° / Plastic 90° / Plastique 90°	1,10€



Referencia Referenc Référence	Color Color Couleur	PVP
85163	Plata / Silver / Argent	0,75€
85167	Blanco / White / Blanc	1,05€
85192	Negro / Black / Noir	1,05€



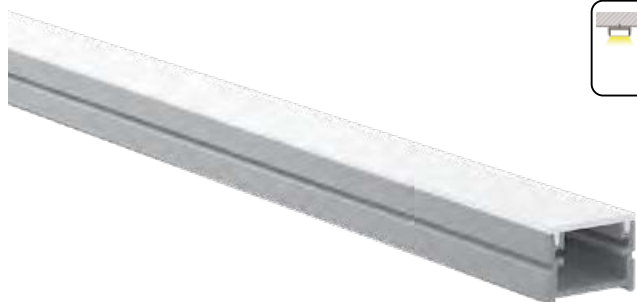

Perfil fabricado con aluminio extrusionado y anodizado. Diseñado como disipador de tiras de LED.

Profile made of extruded and anodized aluminium. Designed as a heatsink for LED strips.

Profil fabriqué en aluminium extrudé et anodisé. Conçu comme dissipateur thermique pour les bandes LED.

IP20

Max. w/m
50 W

AL
6063

Corte
a
medida



Plata 2m
Silver 2m
Argent 2m

Ref.: **83070**
PVP: 11,95€



Blanco 2m
White 2m
Blanc 2m

Ref.: **83071**
PVP: 12,50€



Negro 2m
Black 2m
Noir 2m

Ref.: **83072**
PVP: 12,50€

Escala / Scale / Échelle 1:1

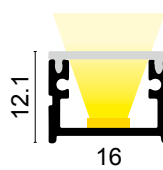
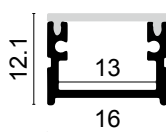

Características técnicas / Technical data / Caractéristiques techniques

Potencia disipada / Power dissipation / Dissipation de puissance	Máx 50 W/M
Aleación de aluminio / Aluminium alloy / Puissance de Roullis	AL 6063
Longitud / Length / Longueur	2 M
IP	20

Difusores / Diffusers / Diffuseurs

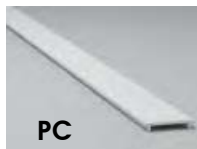

Referencia Reference Référence	Color Color Couleur	Medida Measure Etendue	PVP
83079-PN	Opal / Opal / Opale	2m	7,95€
83079-B	Opal / Opal / Opale	2m	7,95€
83085	Opal / Opal / Opale	Al corte	4,95€/M
83083	Negro / Black / Noir	2m	8,95€
83086	Negro / Black / Noir	Al corte	5,95€/M

Tapas / Caps / Tapas



Referencia Referenc Référence	Color Color Couleur	PVP
83074	Plata / Silver / Argent	
83076	Blanco / White / Blanc	0,50€
83078	Negro / Black / Noir	



Referencia Referenc Référence	Color Color Couleur	PVP
83073	Plata / Silver / Argent	
83075	Blanco / White / Blanc	0,50€
83077	Negro / Black / Noir	

Grapas / Staples / Agrafes



Referencia Reference Référence	Color Color Couleur	PVP
83082	Aluminio / Aluminium / Aluminium	0,80€





Perfil fabricado con aluminio extrusionado y anodizado. Diseñado como disipador de tiras de LED.

Profile made of extruded and anodized aluminium. Designed as a heatsink for LED strips.

Profil fabriqué en aluminium extrudé et anodisé. Conçu comme dissipateur thermique pour les bandes LED.

IP20

Max. w/m
50 W

AL
6063

Cut
to
Size

Plata 2,02m
Silver 2,02m
Argent 2,02m
Ref.: **86120**
PVP: 11,95€

Blanco 2,02m
White 2,02m
Blanc 2,02m
Ref.: **86121**
PVP: 14,45€

Negro 2,02m
Black 2,02m
Noir 2,02m
Ref.: **86122**
PVP: 14,45€

Escala / Scale / Échelle 1:1

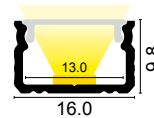
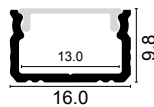

Características técnicas / Technical data / Caractéristiques techniques

Potencia disipada / Power dissipation / Dissipation de puissance	Máx 50 W/M
Aleación de aluminio / Aluminium alloy / Puissance de Roullis	AL 6063
Longitud / Length / Longueur	2,02 M
IP	20

Difusores / Diffusers / Diffuseurs



Referencia Reference Référence	Color Color Couleur	Medida Measure Étendue	PVP
86090	Opal / Opal / Opale	2,02m	5,95€
86091	Opal / Opal / Opale	Al corte	3,45€ / M
86092	Negro / Black / Noir	2,02m	6,95€
86093	Negro / Black / Noir	Al corte	4,45€ / M

Tapas / Caps / Tapas



Referencia Reference Référence	Color Color Couleur	PVP
86124	Plata / Silver / Argent	
86126	Blanco / White / Blanc	0,85€
86128	Negro / Black / Noir	



Referencia Reference Référence	Color Color Couleur	PVP
86123	Plata / Silver / Argent	
86125	Blanco / White / Blanc	0,85€
86127	Negro / Black / Noir	

Grapas / Staples / Agrafes



Referencia Reference Référence	Color Color Couleur	PVP
86109	Aluminio / Aluminium / Aluminium	0,70€
86129	Transparente / Transparent / Transparent	0,90€





Perfil fabricado con aluminio extrusionado y anodizado. Diseñado como disipador de tiras de LED.

Profile made of extruded and anodized aluminium. Designed as a heatsink for LED strips.

Profil fabriqué en aluminium extrudé et anodisé. Conçu comme dissipateur thermique pour les bandes LED.

IP20

Max. w/m
50 W

AL
6063

Cut
to
Size

Plata 2m
Silver 2m
Argent 2m

Ref.: **83320**
PVP: 19,95€

Blanco 2m
White 2m
Blanc 2m

Ref.: **83321**
PVP: 24,95€

Negro 2m
Black 2m
Noir 2m

Ref.: **83322**
PVP: 24,95€

Escala / Scale / Échelle 1:1

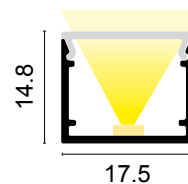
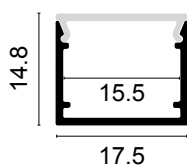



Características técnicas / Technical data / Caractéristiques techniques

Potencia disipada / Power dissipation / Dissipation de puissance	Máx 50 W/M
Aleación de aluminio / Aluminium alloy / Puissance de Roulis	AL 6063
Longitud / Length / Longueur	2 M
IP	20

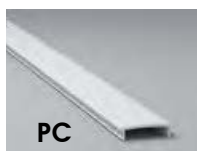
Difusores / Diffusers / Diffuseurs



Referencia Reference Référence	Color Color Couleur	Medida Measure Étendue	PVP
83329	Opal / Opal / Opale	2m	7,95€
83335	Opal / Opal / Opale	Al corte 	4,95€/M
83332	Negro / Black / Noir	2m	11,95€
83336	Negro / Black / Noir	Al corte 	7,95€/M

Grapas / Staples / Agrafes



Referencia Reference Référence	Color Color Couleur	PVP
83331	Aluminio / Aluminium / Aluminium	0,85€

Tapas / Caps / Tapas



Referencia Reference Référence	Color Color Couleur	PVP
83324	Plata / Silver / Argent	
83326	Blanco / White / Blanc	0,70€
83328	Negro / Black / Noir	



Referencia Reference Référence	Color Color Couleur	PVP
83323	Plata / Silver / Argent	
83325	Blanco / White / Blanc	0,70€
83327	Negro / Black / Noir	



BUSAN Perfil de superficie / Surface profile / Profilé de surface



Perfil fabricado con aluminio extrusionado y anodizado. Diseñado como disipador de tiras de LED.

Profile made of extruded and anodized aluminium. Designed as a heatsink for LED strips.

Profil fabriqué en aluminium extrudé et anodisé. Conçu comme dissipateur thermique pour les bandes LED.

IP20

Max. w/m
50 W

AL
6063

Cut
to
Size



Plata 2m
Silver 2m
Argent 2m

Ref.: **85000**
PVP: 21,95€



Blanco 2m
White 2m
Blanc 2m

Ref.: **85001**
PVP: 22,95€



Negro 2m
Black 2m
Noir 2m

Ref.: **85002**
PVP: 23,95€

Escala / Scale / Échelle 1:1

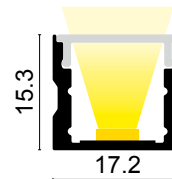
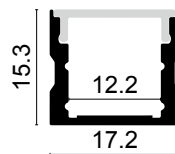

Características técnicas / Technical data / Caractéristiques techniques

Potencia disipada / Power dissipation / Dissipation de puissance	Máx 50 W/M
Aleación de aluminio / Aluminium alloy / Puissance de Roulis	AL 6063
Longitud / Length / Longueur	2 M
IP	20

Difusores / Diffusers / Diffuseurs



Referencia Reference Référence	Color Color Couleur	Medida Measure Etendue	PVP
85009	Opal / Opal / Opale	2m	7,95€

Tapas / Caps / Tapas



Referencia Reference Référence	Color Color Couleur	PVP
85004	Plata / Silver / Argent	
85006	Blanco / White / Blanc	1,95€
85008	Negro / Black / Noir	

Grapas / Staples / Agrafes



Referencia Referenc Référénc	Color Color Couleur	PVP
85010	Aluminio / Aluminium / Aluminium	0,85€
85011	Plastico / Plastic / Plastique	0,70€
85204	Plastico 90° / Plastic 90° / Plastique 90°	1,10€



Referencia Reference Référence	Color Color Couleur	PVP
85003	Plata / Silver / Argent	
85005	Blanco / White / Blanc	1,95€
85007	Negro / Black / Noir	





Perfil fabricado con aluminio extrusionado y anodizado. Diseñado como disipador de tiras de LED.

Profile made of extruded and anodized aluminium. Designed as a heatsink for LED strips.

Profil fabriqué en aluminium extrudé et anodisé. Conçu comme dissipateur thermique pour les bandes LED.

IP20

Max. w/m
50 W

AL
6063

Cut
to
Size

Plata 2,02m
Silver 2,02m
Argent 2,02m
Ref.: **86140**
PVP: 14,95€

Blanco 2,02m
White 2,02m
Blanc 2,02m
Ref.: **86141**
PVP: 18,95€

Negro 2,02m
Black 2,02m
Noir 2,02m
Ref.: **86142**
PVP: 18,95€

Escala / Scale / Échelle 1:1

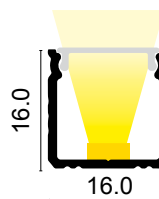
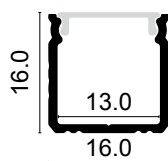

Características técnicas / Technical data / Caractéristiques techniques

Potencia disipada / Power dissipation / Dissipation de puissance	Máx 50 W/M
Aleación de aluminio / Aluminium alloy / Puissance de Roullis	AL 6063
Longitud / Length / Longueur	2,02 M
IP	20

Difusores / Diffusers / Diffuseurs



Referencia Reference Référence	Color Color Couleur	Medida Measure Étendue	PVP
86090	Opal / Opal / Opale	2,02m	5,95€
86091	Opal / Opal / Opale	Al corte	3,45€/M
86092	Negro / Black / Noir	2,02m	6,95€
86093	Negro / Black / Noir	Al corte	4,45€/M

Tapas / Caps / Tapas



Referencia Reference Référence	Color Color Couleur	PVP
86144	Plata / Silver / Argent	0,85€
86146	Blanco / White / Blanc	
86148	Negro / Black / Noir	

Referencia Reference Référence	Color Color Couleur	PVP
86143	Plata / Silver / Argent	0,85€
86145	Blanco / White / Blanc	
86147	Negro / Black / Noir	

Grapas / Staples / Agrafes



Referencia Reference Référence	Color Color Couleur	PVP
86149	Transparente / Transparent / Transparent	0,90€





Perfil fabricado con aluminio extrusionado y anodizado. Diseñado como disipador de tiras de LED.

Profile made of extruded and anodized aluminium. Designed as a heatsink for LED strips.

Profil fabriqué en aluminium extrudé et anodisé. Conçu comme dissipateur thermique pour les bandes LED.

IP20

Max. w/m
50 W

AL
6063

Cut
to
Size

●
Plata 2m
Silver 2m
Argent 2m

Ref.: **83090**
PVP: 15,50€

○
Blanco 2m
White 2m
Blanc 2m

Ref.: **83091**
PVP: 17,15€

●
Negro 2m
Black 2m
Noir 2m

Ref.: **83092**
PVP: 17,15€

Escala / Scale / Échelle 1:1

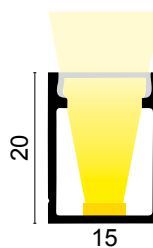
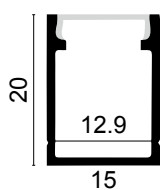

Características técnicas / Technical data / Caractéristiques techniques

Potencia disipada / Power dissipation / Dissipation de puissance	Máx 50 W/M
Aleación de aluminio / Aluminium alloy / Puissance de Roulis	AL 6063
Longitud / Length / Longueur	2 M
IP	20

Difusores / Diffusers / Diffuseurs



Referencia Référence	Color Couleur	Medida Mesure Étendue	PVP
83099	Opal / Opal / Opale	2m	7,25€
83103	Negro / Black / Noir	2m	7,95€

Grapas / Staples / Agrafes



Referencia Référence	Color Couleur	PVP
83102	Aluminio / Aluminium / Aluminium	0,80€

Tapas / Caps / Tapas



Referencia Référence	Color Couleur	PVP
83094	Plata / Silver / Argent	
83096	Blanco / White / Blanc	0,80€
83098	Negro / Black / Noir	



Referencia Référence	Color Couleur	PVP
83093	Plata / Silver / Argent	
83095	Blanco / White / Blanc	0,80€
83097	Negro / Black / Noir	





Perfil fabricado con aluminio extrusionado y anodizado. Diseñado como disipador de tiras de LED.

Profile made of extruded and anodized aluminium. Designed as a heatsink for LED strips.

Profil fabriqué en aluminium extrudé et anodisé. Conçu comme dissipateur thermique pour les bandes LED.

IP20

Max. w/m
50 W

AL
6063

Cut
to
Size

Plata 2m
Silver 2m
Argent 2m

Ref.: **85290**
PVP: 22,95€

Plata 3m
Silver 3m
Argent 3m

Ref.: **85293**
PVP: 34,45€

* Coste de envío de perfil de 3m a consultar en condiciones generales de venta

* Shipping cost of 3m profile to consult in general conditions of sale

* Frais de port du profil 3m à consulter dans les conditions générales de vente

Escala / Scale / Échelle 1:1

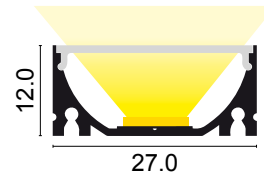
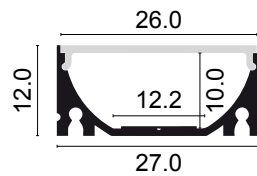

Características técnicas / Technical data / Caractéristiques techniques

Potencia disipada / Power dissipation / Dissipation de puissance	Máx 50 W/M
Aleación de aluminio / Aluminium alloy / Puissance de Roulis	AL 6063
Longitud / Length / Longueur	2 M - 3 M
IP	20

Difusores / Diffusers / Diffuseurs



Referencia Reference Référence	Color Color Couleur	Medida Measure Etendue	PVP
85618	Opal / Opal / Opale	2m	10,95€
85619	Opal / Opal / Opale	3m	16,45€

Tapas / Caps / Tapas



Referencia Reference Référence	Color Color Couleur	PVP
85297	Plata / Silver / Argent	1,10€

Grapas / Staples / Agrafes



Referencia Reference Référence	Color Color Couleur	PVP
85302	Aluminio / Aluminium / Aluminium	0,75€



Referencia Reference Référence	Color Color Couleur	PVP
85296	Plata / Silver / Argent	1,10€



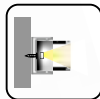

Perfil fabricado con aluminio extrusionado y anodizado. Diseñado como disipador de tiras de LED.

Profile made of extruded and anodized aluminium. Designed as a heatsink for LED strips.

Profil fabriqué en aluminium extrudé et anodisé. Conçu comme dissipateur thermique pour les bandes LED.

IP20

IP⁶⁵*

Max. w/m
50 W

Cut
to
Size

Blanco 2m
White 2m
Blanc 2m
Ref.: **83530**
PVP: 27,95€

***Sellado IP65 para perfil estanco**
**IP65 sealing for watertight profile*
**Étanchéité IP65 pour profil étanche*
Ref.: **90040**
PVP: 15,95€

Escala / Scale / Échelle 1:1

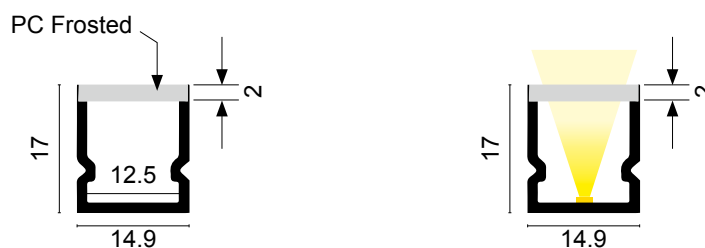

Características técnicas / Technical data / Caractéristiques techniques

Potencia disipada / Power dissipation / Dissipation de puissance	Máx 50 W/M
Longitud / Length / Longueur	2 M
IP	20

Pletina / Platen / Platine

Referencia Reference Référence	Color Color Couleur	Medida Measure Etendue	PVP
83534	Aluminio / Aluminium / Aluminium	2m	7,95€

Grapas / Staples / Agrafes



Referencia Reference Référence	Color Color Couleur	PVP
83533	Blanco / White / Blanc	1,00€

Tapas / Caps / Tapas



Referencia Reference Référence	Color Color Couleur	PVP
83532	Blanco / White / Blanc	1,25€



Referencia Reference Référence	Color Color Couleur	PVP
83531	Blanco / White / Blanc	1,25€



GANGES Perfil de superficie / Surface profile / Profilé de surface

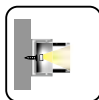
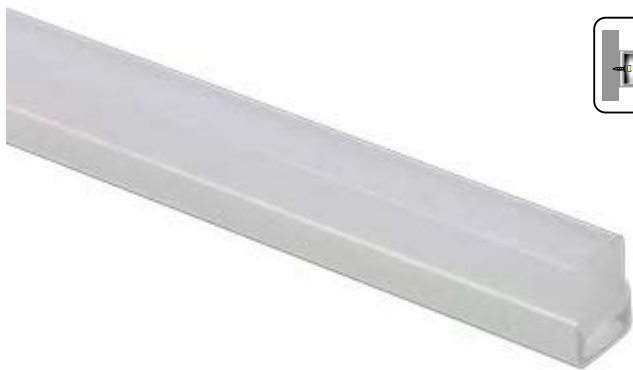

Perfil fabricado con aluminio extrusionado y anodizado. Diseñado como disipador de tiras de LED.

Profile made of extruded and anodized aluminium. Designed as a heatsink for LED strips.

Profil fabriqué en aluminium extrudé et anodisé. Conçu comme dissipateur thermique pour les bandes LED.

IP20

IP65*

Max. w/m
50 W

Cut
to
Size

Blanco 2m
White 2m
Blanc 2m

Ref.: **83550**
PVP: 59,95€

***Sellado IP65 para perfil estanco**
**IP65 sealing for watertight profile*
**Étanchéité IP65 pour profil étanche*

Ref.: **90040**
PVP: 15,95€

Escala / Scale / Échelle 1:1

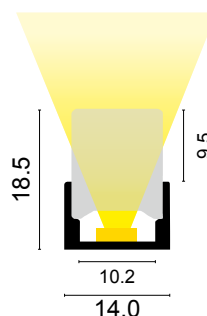
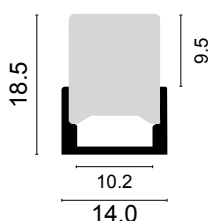

Características técnicas / Technical data / Caractéristiques techniques

Potencia disipada / Power dissipation / Dissipation de puissance	Máx 50 W/M
Longitud / Length / Longueur	2 M
IP	20

Pletina / Platen / Platine

Referencia Reference Référence	Color Color Couleur	Medida Measure Étendue	PVP
83535	Aluminio / Aluminium / Aluminium	2m	5,95€

Grapas / Staples / Agrafes



Referencia Reference Référence	Color Color Couleur	PVP
83552	Blanco / White / Blanc	1,00€





Perfil fabricado con aluminio extrusionado y anodizado. Diseñado como disipador de tiras de LED.

Profile made of extruded and anodized aluminium. Designed as a heatsink for LED strips.

Profil fabriqué en aluminium extrudé et anodisé. Conçu comme dissipateur thermique pour les bandes LED.



Plata 3m
Silver 3m
Argent 3m

***Sellado IP65 para perfil estanco**
*IP65 sealing for watertight profile
*Étanchéité IP65 pour profil étanche

Ref.: **85100**
PVP: 17,95€

Ref.: **90040**
PVP: 15,95€

IP20

IP65

Max. w/m
50 W

AL
6063

Cut
to
Size

* Coste de envío de perfil de 3m a consultar en condiciones generales de venta
* Shipping cost of 3m profile to consult in general conditions of sale
* Frais de port du profil 3m à consulter dans les conditions générales de vente

Escala / Scale / Échelle 1:1

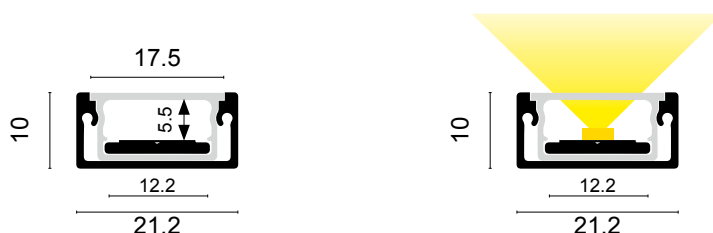

Características técnicas / Technical data / Caractéristiques techniques

Potencia disipada / Power dissipation / Dissipation de puissance	Máx 50 W/M
Aleación de aluminio / Aluminium alloy / Puissance de Roullis	AL 6063
Longitud / Length / Longueur	3 M
IP	20

Pletina / Platen / Platine

Referencia Reference Référence	Color Color Couleur	Medida Measure Etendue	PVP
85136	Aluminio / Aluminium / Aluminium	3m	8,95€

Difusores / Diffusers / Diffuseurs

Referencia Reference Référence	Color Color Couleur	PVP
85107	Opal / Opal / Opale	16,95€

Tapas / Caps / Tapas

Referencia Reference Référence	Color Color Couleur	PVP
85101	Gris / Grey / Gris	0,50€
85102	Gris / Grey / Gris	0,50€
85108	Silicona / Silicone / Silicone	1,45€

Grapas / Staples / Agrafes

Referencia Reference Référence	Color Color Couleur	PVP
85103	Aluminio / Aluminium / Aluminium	0,60€





Perfil fabricado con aluminio extrusionado y anodizado. Diseñado como disipador de tiras de LED.

Profile made of extruded and anodized aluminium. Designed as a heatsink for LED strips.

Profil fabriqué en aluminium extrudé et anodisé. Conçu comme dissipateur thermique pour les bandes LED.



Plata 3m
Silver 3m
Argent 3m

Ref.: **85120**
PVP: 24,95€

***Sellado IP65 para perfil estanco**
**IP65 sealing for watertight profile*
**Étanchéité IP65 pour profil étanche*

Ref.: **90040**
PVP: 15,95€

IP20



Max. w/m
50 W

AL
6063

Cut
to
Size

* Coste de envío de perfil de 3m a consultar en condiciones generales de venta
* Shipping cost of 3m profile to consult in general conditions of sale
* Frais de port du profil 3m à consulter dans les conditions générales de vente

Escala / Scale / Échelle 1:1

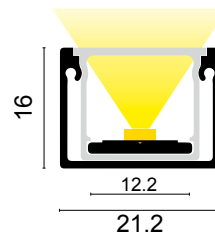
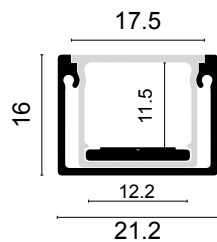

Características técnicas / Technical data / Caractéristiques techniques

Potencia disipada / Power dissipation / Dissipation de puissance	Máx 50 W/M
Aleación de aluminio / Aluminium alloy / Puissance de Roullis	AL 6063
Longitud / Length / Longueur	3 M
IP	20

Pletina / Platen / Platine

Referencia Reference Référence	Color Color Couleur	Medida Measure Étendue	PVP
85136	Aluminio / Aluminium / Aluminium	3m	8,95€

Grapas / Staples / Agrafes

Referencia Reference Référence	Color Color Couleur	PVP
85123	Aluminio / Aluminium / Aluminium	0,80€

Difusores / Diffusers / Diffuseurs

Referencia Reference Référence	Color Color Couleur	Medida Measure Étendue	PVP
85127	Opal / Opal / Opale	3m	22,95€

Tapas / Caps / Tapas

Referencia Reference Référence	Color Color Couleur	PVP
85121	Gris / Grey / Gris	0,50€

Referencia Reference Référence	Color Color Couleur	PVP
85122	Gris / Grey / Gris	0,50€

Referencia Reference Référence	Color Color Couleur	PVP
85128	Silicona / Silicone / Silicone	1,45€





Perfil fabricado con aluminio extrusionado y anodizado. Diseñado como disipador de tiras de LED.

Profile made of extruded and anodized aluminium. Designed as a heatsink for LED strips.

Profil fabriqué en aluminium extrudé et anodisé. Conçu comme dissipateur thermique pour les bandes LED.

Plata 2m IP20
Silver 2m IP20
Argent 2m IP20

Ref.: **85140**
PVP: 12,95€

***Sellado IP65 para perfil estanco**
*IP65 sealing for watertight profile
*Étanchéité IP65 pour profil étanche

Ref.: **90040**
PVP: 15,95€

IP20

IP65*

Max. w/m
50 W

AL
6063

Cut
to
Size

Escala / Scale / Échelle 1:1

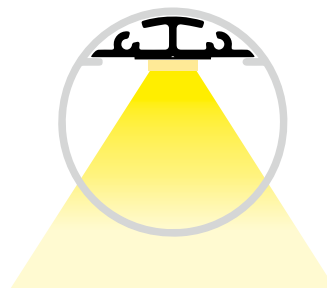
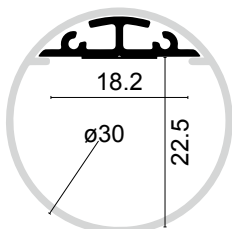

Características técnicas / Technical data / Caractéristiques techniques

Potencia disipada / Power dissipation / Dissipation de puissance	Máx 50 W/M
Aleación de aluminio / Aluminium alloy / Puissance de Roullis	AL 6063
Longitud / Length / Longueur	2M
IP	20

Difusores / Diffusers / Diffuseurs



Referencia Reference Référence	Color Color Couleur	Medida Measure Étendue	PVP
85141	Opal / Opal / Opale	2m	20,40€

Grapas / Staples / Agrafes



Referencia Reference Référence	Color Color Couleur	PVP
85143	Blanco / White / Blanc	1,25€

Tapas / Caps / Tapas



Referencia Reference Référence	Color Color Couleur	PVP
85022	Gris / Grey / Gris	1,65€



Referencia Reference Référence	Color Color Couleur	PVP
85023	Gris / Grey / Gris	1,65€



Referencia Reference Référence	Color Color Couleur	PVP
85142	Silicona / Silicone / Silicone	1,45€



LYOPRO

LED PROFILE



Perfil Superficie Suspensión
Profile Surface Suspension
Profilé Surface Suspension



Perfil fabricado con aluminio extrusionado y anodizado. Diseñado como disipador de tiras de LED.

Profile made of extruded and anodized aluminium. Designed as a heatsink for LED strips.

Profil fabriqué en aluminium extrudé et anodisé. Conçu comme dissipateur thermique pour les bandes LED.

● Plata 2m
Silver 2m
Argent 2m
Ref.: **83670**
PVP: 42,95€

○ Blanco 2m
White 2m
Blanc 2m
Ref.: **83671**
PVP: 52,65€

● Negro 2m
Black 2m
Noir 2m
Ref.: **83672**
PVP: 52,65€

IP20

Max. w/m
100 W

AL
6063

Cut
to
Size

Escala / Scale / Échelle 1:1

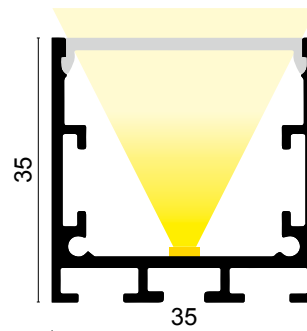
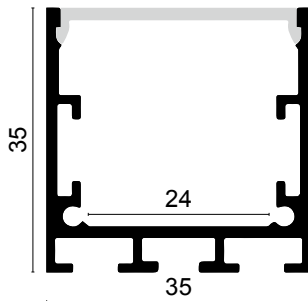



Características técnicas / Technical data / Caractéristiques techniques

Potencia disipada / Power dissipation / Dissipation de puissance	Máx 50 W/M
Aleación de aluminio / Aluminium alloy / Puissance de Roulis	AL 6063
Longitud / Length / Longueur	2 M
IP	20

Difusores / Diffusers / Diffuseurs



Referencia Référence	Color Couleur	Medida Measure Étendue	PVP
83679	Opal / Opal / Opale	2m	9,95€
83685	Opal / Opal / Opale	Al corte 	5,95€/M
83680	Negro / Black / Noir	2m	13,95€
83686	Negro / Black / Noir	Al corte 	7,95€/M

Tapas / Caps / Tapas



Referencia Référence	Color Couleur	PVP
83674	Plata / Silver / Argent	
83676	Blanco / White / Blanc	2,10€
83678	Negro / Black / Noir	



Referencia Référence	Color Couleur	PVP
83673	Plata / Silver / Argent	
83675	Blanco / White / Blanc	2,10€
83677	Negro / Black / Noir	

Suspensión / Suspension / Suspension



Referencia Référence	Milímetros Millimeters Millimètres	PVP
88021	1.000 mm	18,95€
88022	1.250 mm	21,95€
88023	1.500 mm	24,45€
88024	2.000 mm	27,95€
88025	3.000 mm	32,45€
88026	4.000 mm	37,95€
88027	5.000 mm	42,95€

*Cable de suspensión electrificado a consultar.
*Electrified suspension cable to consult.
*Câble de suspension électrifié à consulter.

Conector / Connector / Connecteur

Referencia Référence	Color Couleur	PVP
85027	Aluminio / Aluminium / Aluminium	2,60€
85028	Aluminio / Aluminium / Aluminium	3,65€
85029	Aluminio / Aluminium / Aluminium	3,25€
85030	Aluminio / Aluminium / Aluminium	3,65€



85027

85028

85029

85030

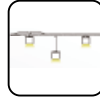

Perfil fabricado con aluminio extrusionado y anodizado. Diseñado como disipador de tiras de LED.

Profile made of extruded and anodized aluminium. Designed as a heatsink for LED strips.

Profil fabriqué en aluminium extrudé et anodisé. Conçu comme dissipateur thermique pour les bandes LED.

IP20

Max. w/m
100 W

AL
6063

Cut
to
Size



Plata 2m
Silver 2m
Argent 2m

Ref.: **83690**
PVP: 59,95€



Blanco 2m
White 2m
Blanc 2m

Ref.: **83691**
PVP: 64,45€



Negro 2m
Black 2m
Noir 2m

Ref.: **83692**
PVP: 64,45€

Escala / Scale / Échelle 1:1

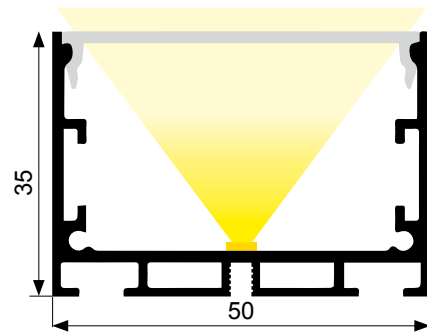
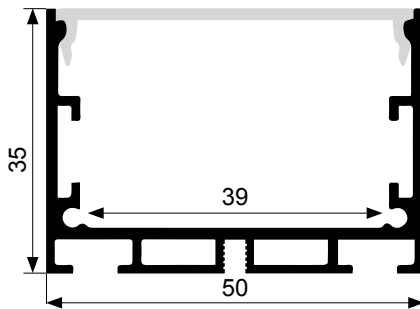

Características técnicas / Technical data / Caractéristiques techniques

Potencia disipada / Power dissipation / Dissipation de puissance	Máx 50 W/M
Aleación de aluminio / Aluminium alloy / Puissance de Roullis	AL 6063
Longitud / Length / Longueur	2 M
IP	20

Difusores / Diffusers / Diffuseurs

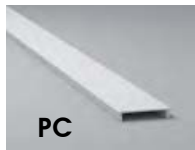

PC



PMMA

Referencia Reference Référence	Color Color Couleur	Medida Measure Etendue	PVP
83699	Opal / Opal / Opale	2m	12,85€
83705	Opal / Opal / Opale	Al corte	7,95€/M
83700	Negro / Black / Noir	2m	16,10€
83706	Negro / Black / Noir	Al corte	9,95€/M

Tapas / Caps / Tapas



Referencia Reference Référence	Color Color Couleur	PVP
83694	Plata / Silver / Argent	
83696	Blanco / White / Blanc	2,10€
83698	Negro / Black / Noir	

Referencia Reference Référence	Color Color Couleur	PVP
83693	Plata / Silver / Argent	
83695	Blanco / White / Blanc	2,10€
83697	Negro / Black / Noir	

Suspensión / Suspension / Suspension



Referencia Reference Référence	Milímetros Millimeters Millimètres	PVP
83703	1.000 mm	14,95€
83724	1.250 mm	15,95€
83725	1.500 mm	16,95€
83726	2.000 mm	18,95€
83727	3.000 mm	22,95€
83728	4.000 mm	26,95€
83729	5.000 mm	29,95€

*Cable de suspensión electrificado a consultar.
*Electrified suspension cable to consult.
*Câble de suspension électrifié à consulter.

Conector / Connector / Connecteur

Referencia Reference Référence	Color Color Couleur	PVP
85027	Aluminio / Aluminium / Aluminium	2,60€
85028	Aluminio / Aluminium / Aluminium	3,65€
85029	Aluminio / Aluminium / Aluminium	3,25€
85030	Aluminio / Aluminium / Aluminium	3,65€



85027



85028



85029



85030

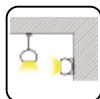

Perfil fabricado con aluminio extrusionado y anodizado. Diseñado como disipador de tiras de LED.

Profile made of extruded and anodized aluminium. Designed as a heatsink for LED strips.

Profil fabriqué en aluminium extrudé et anodisé. Conçu comme dissipateur thermique pour les bandes LED.



Plata 2m
Silver 2m
Argent 2m

Ref.: **83110**
PVP: 14,95€



Blanco 2m
White 2m
Blanc 2m

Ref.: **83111**
PVP: 16,95€



Negro 2m
Black 2m
Noir 2m

Ref.: **83112**
PVP: 16,95€

IP20

Max. w/m
50 W

AL
6063

Cut
to
Size

Escala / Scale / Échelle 1:1

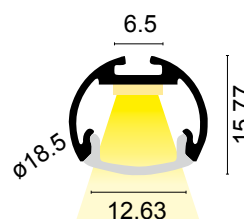
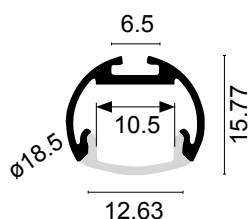

Características técnicas / Technical data / Caractéristiques techniques

Potencia disipada / Power dissipation / Dissipation de puissance	Máx 50 W/M
Aleación de aluminio / Aluminium alloy / Puissance de Roulis	AL 6063
Longitud / Length / Longueur	2 M
IP	20

Difusores / Diffusers / Diffuseurs

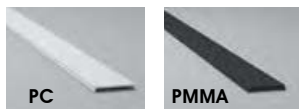

Referencia Reference Référence	Color Color Couleur	Medida Measure Etendue	PVP
83119	Opal / Opal / Opale	2m	6,95€
83126	Negro / Black / Noir	2m	7,95€

Suspensión / Suspension / Suspension



Referencia Reference Référence	Milímetros Millimeters Millimètres	PVP
83127	1.000 mm	15,95€

Tapas / Caps / Tapas



Referencia Reference Référence	Color Color Couleur	PVP
83114	Plata / Silver / Argent	
83116	Blanco / White / Blanc	0,50€
83118	Negro / Black / Noir	



Referencia Reference Référence	Color Color Couleur	PVP
83113	Plata / Silver / Argent	
83115	Blanco / White / Blanc	0,50€
83117	Negro / Black / Noir	





Perfil fabricado con aluminio extrusionado y anodizado. Diseñado como disipador de tiras de LED.

Profile made of extruded and anodized aluminium. Designed as a heatsink for LED strips.

Profil fabriqué en aluminium extrudé et anodisé. Conçu comme dissipateur thermique pour les bandes LED.

Plata 2m
Silver 2m
Argent 2m
Ref.: **83650**
PVP: 19,30€

Blanco 2m
White 2m
Blanc 2m
Ref.: **83651**
PVP: 21,45€

Negro 2m
Black 2m
Noir 2m
Ref.: **83652**
PVP: 21,45€

IP20

Max. w/m
50 W

AL
6063

Cut
to
Size

Escala / Scale / Échelle 1:1

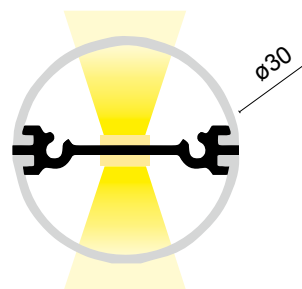
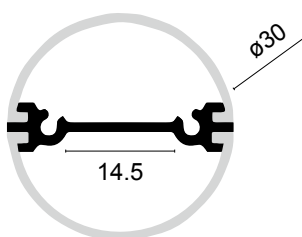

Características técnicas / Technical data / Caractéristiques techniques

Potencia disipada / Power dissipation / Dissipation de puissance	Máx 50 W/M
Aleación de aluminio / Aluminium alloy / Puissance de Roulis	AL 6063
Longitud / Length / Longueur	2 M
IP	20

Difusores / Diffusers / Diffuseurs

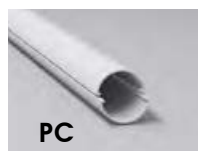

PC



PMMA

Referencia Reference Référence	Color Color Couleur	Medida Measure Étendue	PVP
83659	Opal / Opal / Opale	2m	16,95€
83660	Negro / Black / Noir	2m	19,95€

Tapas / Caps / Tapas



Referencia Reference Référence	Color Color Couleur	PVP
83654	Plata / Silver / Argent	
83656	Blanco / White / Blanc	2,70€
83658	Negro / Black / Noir	

Referencia Reference Référence	Color Color Couleur	PVP
83653	Plata / Silver / Argent	
83655	Blanco / White / Blanc	2,70€
83657	Negro / Black / Noir	

Suspensión / Suspension / Suspension



Referencia Reference Référence	Milímetros Millimeters Millimètres	PVP
88021	1.000 mm	18,95€
88022	1.250 mm	21,95€
88023	1.500 mm	24,45€
88024	2.000 mm	27,95€
88025	3.000 mm	32,95€
88026	4.000 mm	37,95€
88027	5.000 mm	42,95€

*Cable de suspensión electrificado a consultar.
*Electrified suspension cable to consult.
*Câble de suspension électrifié à consulter.

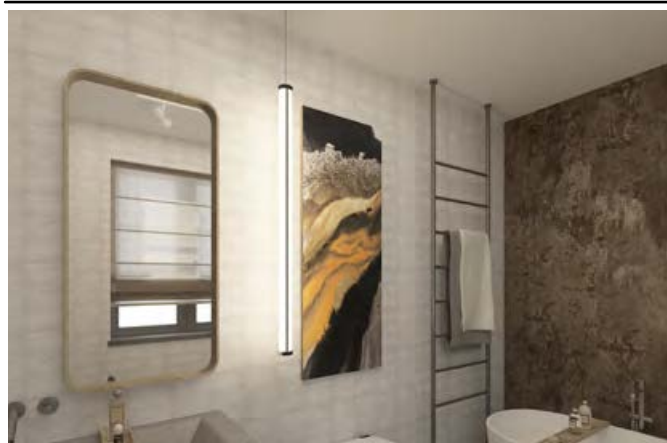



Perfil fabricado con aluminio extrusionado y anodizado. Diseñado como disipador de tiras de LED.

Profile made of extruded and anodized aluminium. Designed as a heatsink for LED strips.

Profil fabriqué en aluminium extrudé et anodisé. Conçu comme dissipateur thermique pour les bandes LED.

Plata 2m
Silver 2m
Argent 2m

Ref.: **85020**
PVP: 13,95€

IP20

Max. w/m
50 W

AL
6063

Cut
to
Size

Escala / Scale / Échelle 1:1

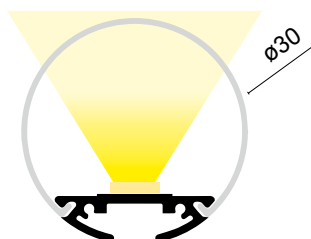
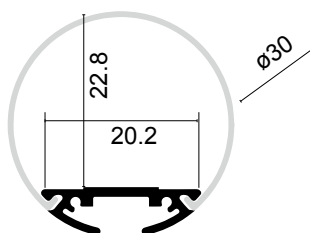

Características técnicas / Technical data / Caractéristiques techniques

Potencia disipada / Power dissipation / Dissipation de puissance	Máx 50 W/M
Aleación de aluminio / Aluminium alloy / Puissance de Roullis	AL 6063
Longitud / Length / Longueur	2 M
IP	20

Difusores / Diffusers / Diffuseurs



Referencia Reference Référence	Color Color Couleur	Medida Measure Étendue	PVP
85021	Opal / Opal / Opale	2m	14,95€

Suspensión / Suspension / Suspension



Referencia Reference Référence	Milímetros Millimeters Millimètres	PVP U.
85024	2.000 mm	12,25€



Referencia Reference Référence	Milímetros Millimeters Millimètres	PVP U.
85025	2.000 mm	12,25€



Tapas / Caps / Tapas



Referencia Reference Référence	Color Color Couleur	PVP
85022	Gris / Grey / Gris	1,65€



Referencia Reference Référence	Color Color Couleur	PVP
85023	Gris / Grey / Gris	1,65€

Conector / Connector / Connecteur

Referencia Reference Référence	Color Color Couleur	PVP
85027	Aluminio / Aluminium / Aluminium	2,60€
85028	Aluminio / Aluminium / Aluminium	3,65€
85029	Aluminio / Aluminium / Aluminium	3,25€
85030	Aluminio / Aluminium / Aluminium	3,65€



85027



85028



85029



85030

Grapas / Staples / Agrafes



Referencia Reference Référence	Color Color Couleur	PVP
85026	Aluminio / Aluminium / Aluminium	3,25€



Perfil fabricado con aluminio extrusionado y anodizado. Diseñado como disipador de tiras de LED.

Profile made of extruded and anodized aluminium. Designed as a heatsink for LED strips.

Profil fabriqué en aluminium extrudé et anodisé. Conçu comme dissipateur thermique pour les bandes LED.



Plata 2m
Silver 2m
Argent 2m

Ref.: **85040**
PVP: 32,20€

IP20

Max. w/m
100 W

AL
6063

Cut
to
Size

Escala / Scale / Échelle 1:1

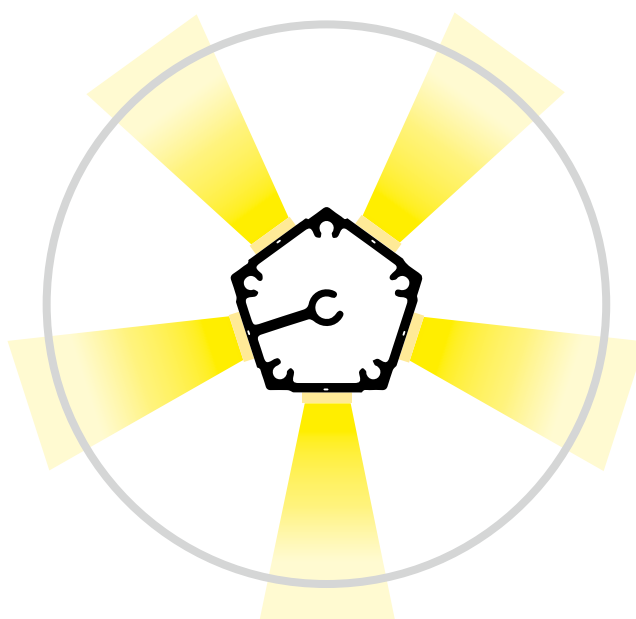
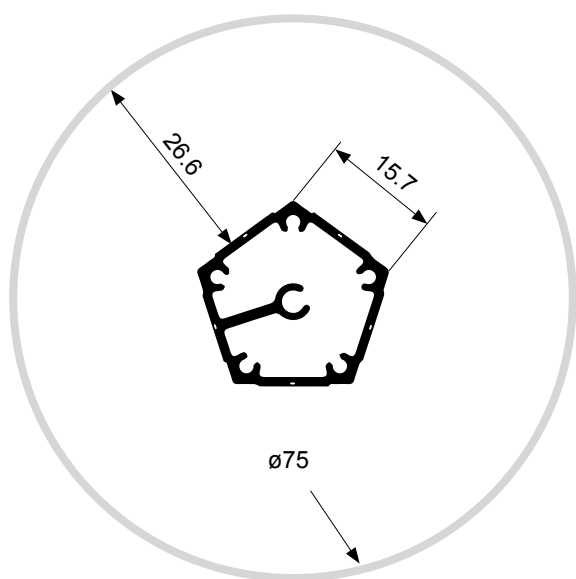

Características técnicas / Technical data / Caractéristiques techniques

Potencia disipada / Power dissipation / Dissipation de puissance	Máx 100 W/M
Aleación de aluminio / Aluminium alloy / Puissance de Roulis	AL 6063
Longitud / Length / Longueur	2 M
IP	20

Difusores / Diffusers / Diffuseurs



Referencia Reference Référence	Color Color Couleur	Medida Measure Etendue	PVP
85041	Opal / Opal / Opale	2m	49,40€

Suspensión / Suspension / Suspension



Referencia Reference Référence	Milímetros Millimeters Millimètres	PVP U.
85043	2.000 mm	14,95€

Tapas / Caps / Tapas



Referencia Reference Référence	Color Color Couleur	PVP
85042	Gris / Grey / Gris	2,90€



LYOPRO

LED PROFILE

Perfil Angular
Angle Profile
Profilé D'angle

LAGOS Perfil angular / Angle profile / Profilé d'angle



Perfil fabricado con aluminio extrusionado y anodizado. Diseñado como disipador de tiras de LED.

Profile made of extruded and anodized aluminium. Designed as a heatsink for LED strips.

Profil fabriqué en aluminium extrudé et anodisé. Conçu comme dissipateur thermique pour les bandes LED.

Plata 2m
Silver 2m
Argent 2m

Ref.: **85310**
PVP: 8,95€

IP20

Max. w/m
50 W

AL
6063

Cut
to
Size

Escala / Scale / Échelle 1:1



10.0



10.0

Características técnicas / Technical data / Caractéristiques techniques

Potencia disipada / Power dissipation / Dissipation de puissance	Máx 50 W/M
Aleación de aluminio / Aluminium alloy / Puissance de Roullis	AL 6063
Longitud / Length / Longueur	2 M
IP	20

— Difusores / Diffusers / Diffuseurs

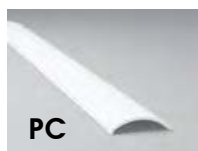

Referencia Reference Référence	Color Color Couleur	Medida Measure Etendue	PVP
85311	Opal / Opal / Opale	2m	6,75€

— Tapas / Caps / Tapas



Referencia Reference Référence	Color Color Couleur	PVP
85312	Gris / Grey / Gris	1,10€



GLASGOW Perfil angular / Angle profile / Profilé d'angle

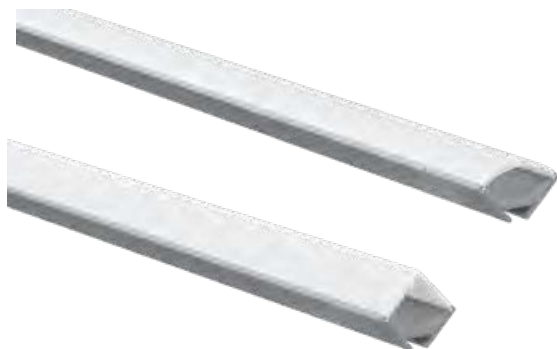

Perfil fabricado con aluminio extrusionado y anodizado. Diseñado como disipador de tiras de LED.

Profile made of extruded and anodized aluminium. Designed as a heatsink for LED strips.

Profil fabriqué en aluminium extrudé et anodisé. Conçu comme dissipateur thermique pour les bandes LED.



Plata 2m
Silver 2m
Argent 2m

Ref.: **83190**
PVP: 10,95€



Blanco 2m
White 2m
Blanc 2m

Ref.: **83191**
PVP: 12,95€



Negro 2m
Black 2m
Noir 2m

Ref.: **83192**
PVP: 12,95€

IP20

Max. w/m
50 W

AL
6063

Cut
to
Size

Escala / Scale / Échelle 1:1

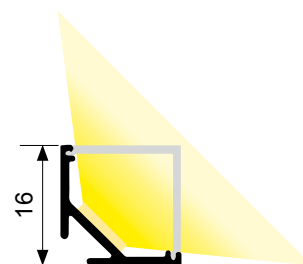
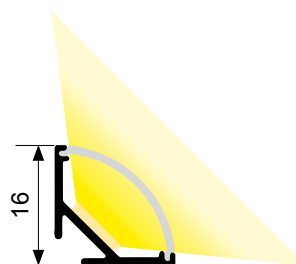
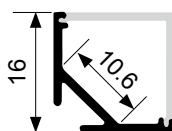
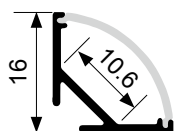

Características técnicas / Technical data / Caractéristiques techniques

Potencia disipada / Power dissipation / Dissipation de puissance	Máx 50 W/M
Aleación de aluminio / Aluminium alloy / Puissance de Roullis	AL 6063
Longitud / Length / Longueur	2 M
IP	20

Difusores / Diffusers / Diffuseurs



Referencia Reference Référence	Forma Shape Forme	Color Color Couleur	Medida Measure Étendue	PVP
83205	Curva / Curve / Courbe	Opal / Opal / Opale	2m	7,95€
83215	Curva / Curve / Courbe	Opal / Opal / Opale	Al corte 4,95€/M	
83208	Cuadrada / Square / Carré	Opal / Opal / Opale	2m	8,95€
83212	Curva / Curve / Courbe	Negro / Black / Noir	2m	8,95€
83216	Curva / Curve / Courbe	Negro / Black / Noir	Al corte 5,95€/M	
83213	Cuadrada / Square / Carré	Negro / Black / Noir	2m	9,95€

Grapas / Staples / Agrafes



Referencia Reference Référence	Color Color Couleur	PVP
83211	Aluminio / Aluminium / Aluminium	0,80€

Tapas / Caps / Tapas

Referencia Reference Référence	Forma Shape Forme	Color Color Couleur	PVP
83194	Curva / Curve / Courbe	Plata / Silver / Argent	
83196	Curva / Curve / Courbe	Blanco / White / Blanc	0,80€
83198	Curva / Curve / Courbe	Negro / Black / Noir	
83200	Cuadrada / Square / Carré	Plata / Silver / Argent	
83202	Cuadrada / Square / Carré	Blanco / White / Blanc	0,80€
83204	Cuadrada / Square / Carré	Negro / Black / Noir	
83193	Curva / Curve / Courbe	Plata / Silver / Argent	
83195	Curva / Curve / Courbe	Blanco / White / Blanc	0,80€
83197	Curva / Curve / Courbe	Negro / Black / Noir	
83199	Cuadrada / Square / Carré	Plata / Silver / Argent	
83201	Cuadrada / Square / Carré	Blanco / White / Blanc	0,80€
83203	Cuadrada / Square / Carré	Negro / Black / Noir	

ROMA Perfil angular / Angle profile / Profilé d'angle



Perfil fabricado con aluminio extrusionado y anodizado. Diseñado como disipador de tiras de LED.

Profile made of extruded and anodized aluminium. Designed as a heatsink for LED strips.

Profil fabriqué en aluminium extrudé et anodisé. Conçu comme dissipateur thermique pour les bandes LED.

IP20

Max. w/m
50 W

AL
6063

Cut
to
Size

Plata 2m
Silver 2m
Argent 2m

Plata 3m
Silver 3m
Argent 3m

Ref.: **85170**
PVP: 10,95€

Ref.: **85177**
PVP: 16,45€

* Coste de envío de perfil de 3m a consultar en condiciones generales de venta

* Shipping cost of 3m profile to consult in general conditions of sale

* Frais de port du profil 3m à consulter dans les conditions générales de vente

Escala / Scale / Échelle 1:1

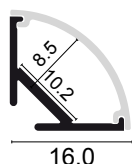

Características técnicas / Technical data / Caractéristiques techniques

Potencia disipada / Power dissipation / Dissipation de puissance	Máx 50 W/M
Aleación de aluminio / Aluminium alloy / Puissance de Roullis	AL 6063
Longitud / Length / Longueur	2 M - 3 M
IP	20

Difusores / Diffusers / Diffuseurs

Referencia Reference Référence	Color Color Couleur	Medida Measure Étendue	PVP
85171	Opal / Opal / Opale	2m	8,95€
85178	Opal / Opal / Opale	3m	13,45€

Tapas / Caps / Tapas

Referencia Reference Référence	Forma Shape Forme	Color Color Couleur	PVP
85172	Curva / Curve / Courbe	Plata / Silver / Argent	1,10€
85173	Curva / Curve / Courbe	Plata / Silver / Argent	1,10€

Grapas / Staples / Agrafes

Referencia Referenc Référence	Color Color Couleur	PVP
85174	Aluminio / Aluminium / Aluminium	0,95€
Referencia Referenc Référence	Color Color Couleur	PVP
85175	Plastico / Plastic / Plastique	1,10€
Referencia Referenc Référence	Color Color Couleur	PVP
85204	Plastico 90° / Plastic 90° / Plastique 90°	1,10€



LEEDS Perfil angular / Angle profile / Profilé d'angle



Perfil fabricado con aluminio extrusionado y anodizado. Diseñado como disipador de tiras de LED.

Profile made of extruded and anodized aluminium. Designed as a heatsink for LED strips.

Profil fabriqué en aluminium extrudé et anodisé. Conçu comme dissipateur thermique pour les bandes LED.

IP20

Max. w/m
50 W

AL
6063

Cut
to
Size

Plata 2m
Silver 2m
Argent 2m

Plata 3m
Silver 3m
Argent 3m

Ref.: **85320**
PVP: 28,95€

Ref.: **85321**
PVP: 43,95€

* Coste de envío de perfil de 3m a consultar en condiciones generales de venta

* Shipping cost of 3m profile to consult in general conditions of sale

* Frais de port du profil 3m à consulter dans les conditions générales de vente

Escala / Scale / Échelle 1:1

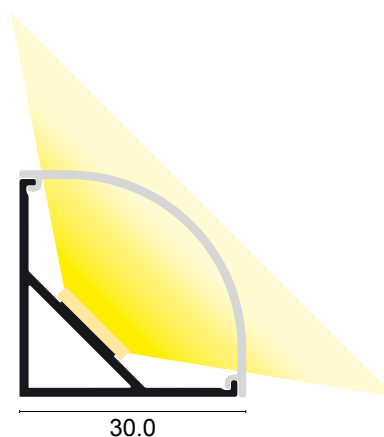
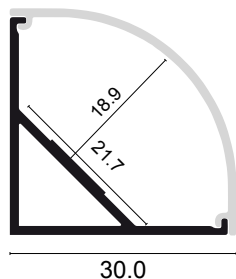

Características técnicas / Technical data / Caractéristiques techniques

Potencia disipada / Power dissipation / Dissipation de puissance	Máx 50 W/M
Aleación de aluminio / Aluminium alloy / Puissance de Roullis	AL 6063
Longitud / Length / Longueur	2 M - 3 M
IP	20

Difusores / Diffusers / Diffuseurs

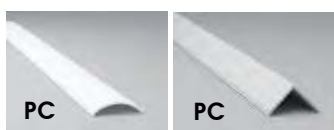

Referencia Reference Référence	Forma Shape Forme	Color Color Couleur	Medida Measure Étendue	PVP
85628	Curva / Curve / Courbe	Opal / Opal / Opale	2m	19,95€
85630	Cuadrada / Square / Carré	Opal / Opal / Opale	2m	19,95€
85629	Curva / Curve / Courbe	Opal / Opal / Opale	3m	29,95€
85631	Cuadrada / Square / Carré	Opal / Opal / Opale	3m	29,95€

Grapas / Staples / Agrafes



Referencia Referenc Référence	Color Color Couleur	PVP
85333	Aluminio / Aluminium / Aluminium	0,75€
85334	Plastico / Plastic / Plastique	0,75€
85204	Plastico 90° / Plastic 90° / Plastique 90°	1,10€

Tapas / Caps / Tapas

Referencia Reference Référence	Forma Shape Forme	Color Color Couleur	PVP
85327	Curva / Curve / Courbe	Plata / Silver / Argent	1,10€
85329	Cuadrada / Square / Carré	Plata / Silver / Argent	1,10€
85326	Curva / Curve / Courbe	Plata / Silver / Argent	1,10€
85328	Cuadrada / Square / Carré	Plata / Silver / Argent	1,10€

UTENA Perfil angular / Angle profile / Profilé d'angle



Perfil fabricado con aluminio extrusionado y anodizado. Diseñado como disipador de tiras de LED.

Profile made of extruded and anodized aluminium. Designed as a heatsink for LED strips.

Profil fabriqué en aluminium extrudé et anodisé. Conçu comme dissipateur thermique pour les bandes LED.

IP20

Max. w/m
50 W

AL
6063

Cut
to
Size

Plata 2,02m
Silver 2,02m
Argent 2,02m
Ref.: **86220**
PVP: 13,50€

Blanco 2,02m
White 2,02m
Blanc 2,02m
Ref.: **86221**
PVP: 19,20€

Negro 2,02m
Black 2,02m
Noir 2,02m
Ref.: **86222**
PVP: 19,20€

Escala / Scale / Échelle 1:1

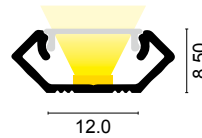
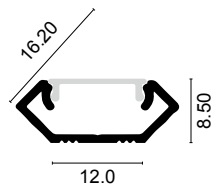

Características técnicas / Technical data / Caractéristiques techniques

Potencia disipada / Power dissipation / Dissipation de puissance	Máx 50 W/M
Aleación de aluminio / Aluminium alloy / Puissance de Roulis	AL 6063
Longitud / Length / Longueur	2,02 M
IP	20

Difusores / Diffusers / Diffuseurs



Referencia Reference Référence	Color Color Couleur	Medida Measure Étendue	PVP
86090	Opal / Opal / Opale	2,02m	5,95€
86091	Opal / Opal / Opale	Al corte	3,45€
86092	Negro / Black / Noir	2,02m	6,95€
86093	Negro / Black / Noir	Al corte	4,45€

Tapas / Caps / Tapas



Referencia Reference Référence	Color Color Couleur	PVP
86244	Plata / Silver / Argent	
86246	Blanco / White / Blanc	0,85€
86248	Negro / Black / Noir	



Referencia Reference Référence	Color Color Couleur	PVP
86243	Plata / Silver / Argent	
86245	Blanco / White / Blanc	0,85€
86247	Negro / Black / Noir	

Grapas / Staples / Agrafes



Referencia Reference Référence	Color Color Couleur	PVP
86249	Transparente / Transparent / Transparent	0,90€



MONTREAL Perfil angular / Angle profile / Profilé d'angle

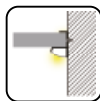

Perfil fabricado con aluminio extrusionado y anodizado. Diseñado como disipador de tiras de LED.

Profile made of extruded and anodized aluminium. Designed as a heatsink for LED strips.

Profil fabriqué en aluminium extrudé et anodisé. Conçu comme dissipateur thermique pour les bandes LED.

Plata 2m
Silver 2m
Argent 2m

Ref.: **83220**
PVP: 22,95€

IP20

Max. w/m
50 W

AL
6063

Cut
to
Size

Escala / Scale / Échelle 1:1

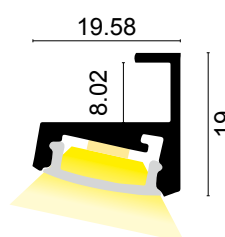
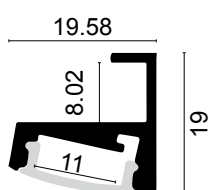

Características técnicas / Technical data / Caractéristiques techniques

Potencia disipada / Power dissipation / Dissipation de puissance	Máx 50 W/M
Aleación de aluminio / Aluminium alloy / Puissance de Roullis	AL 6063
Longitud / Length / Longueur	2 M
IP	20

Difusores PC / Diffusers PC / Diffuseurs PC



Referencia Reference Référence	Color Color Couleur	Medida Measure Étendue	PVP
83229	Opal / Opal / Opale	2m	4,95€

Tapas / Caps / Tapas



Referencia Reference Référence	Color Color Couleur	PVP
83224	Plata / Silver / Argent	0,80€

Referencia Reference Référence	Color Color Couleur	PVP
83223	Plata / Silver / Argent	0,80€

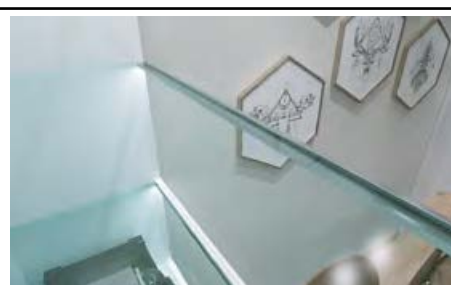

8MM GLASS



RECIFE Perfil angular / Angle profile / Profilé d'angle

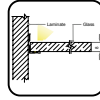
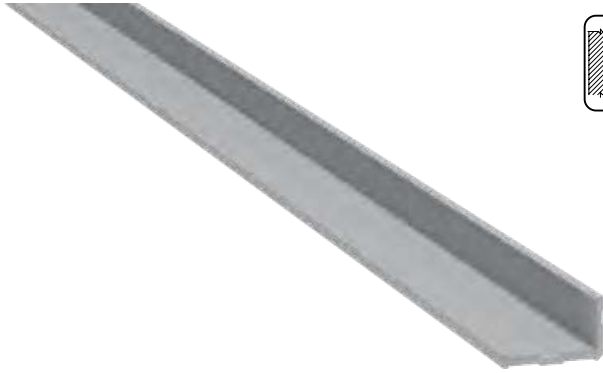

Perfil fabricado con aluminio extrusionado y anodizado. Diseñado como disipador de tiras de LED.

Profile made of extruded and anodized aluminium. Designed as a heatsink for LED strips.

Profil fabriqué en aluminium extrudé et anodisé. Conçu comme dissipateur thermique pour les bandes LED.



Plata 2m
Silver 2m
Argent 2m

Ref.: **83640**
PVP: 10,70€



Blanco 2m
White 2m
Blanc 2m

Ref.: **83641**
PVP: 12,85€



Negro 2m
Black 2m
Noir 2m

Ref.: **83642**
PVP: 12,85€

IP20

Max. w/m
50 W

AL
6063

Cut
to
Size

Escala / Scale / Échelle 1:1

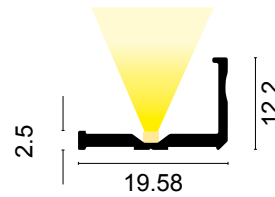
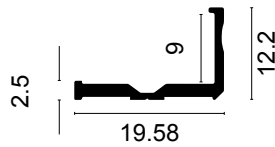

Características técnicas / Technical data / Caractéristiques techniques

Potencia disipada / Power dissipation / Dissipation de puissance	Máx 50 W/M
Aleación de aluminio / Aluminium alloy / Puissance de Roulis	AL 6063
Longitud / Length / Longueur	2 M
IP	20



EBRO Perfil angular / Angle profile / Profilé d'angle



Perfil fabricado con aluminio extrusionado y anodizado. Diseñado como disipador de tiras de LED.

Profile made of extruded and anodized aluminium. Designed as a heatsink for LED strips.

Profil fabriqué en aluminium extrudé et anodisé. Conçu comme dissipateur thermique pour les bandes LED.

IP20



Max. w/m
14,4 W

Cut to Size



Blanco 2m
White 2m
Blanc 2m

Ref.: **83540**
PVP: 22,50€

***Sellado IP65 para perfil estanco**
**IP65 sealing for watertight profile*
**Étanchéité IP65 pour profil étanche*

Ref.: **90040**
PVP: 15,95€

Escala / Scale / Échelle 1:1

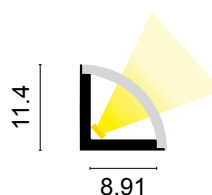
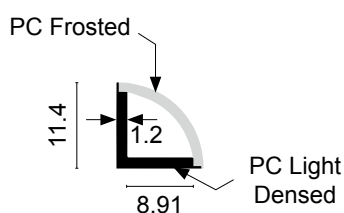

Características técnicas / Technical data / Caractéristiques techniques

Potencia disipada / Power dissipation / Dissipation de puissance	Máx 14,4 W/M
Longitud / Length / Longueur	2 M
IP	20

Pletina / Platen / Platine

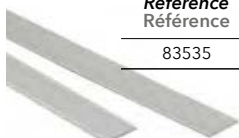

Referencia Reference Référence	Color Color Couleur	Medida Measure Étendue	PVP
83535	Aluminio / Aluminium / Aluminium	2m	5,95€

Grapas / Staples / Agrafes



Referencia Reference Référence	Color Color Couleur	PVP
83543	Blanco / White / Blanc	1,00€

Tapas / Caps / Tapas



Referencia Reference Référence	Color Color Couleur	PVP
83542	Blanco / White / Blanc	1,25€



Referencia Reference Référence	Color Color Couleur	PVP
83541	Blanco / White / Blanc	1,25€



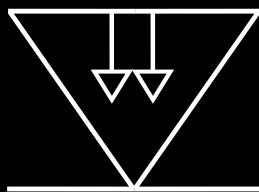

LYOPRO

LED PROFILE

Perfil Empotrar
Recessed profile
Profilé encastré

BURDEOS Perfil empotrar / Recessed profile / Profilé encastré

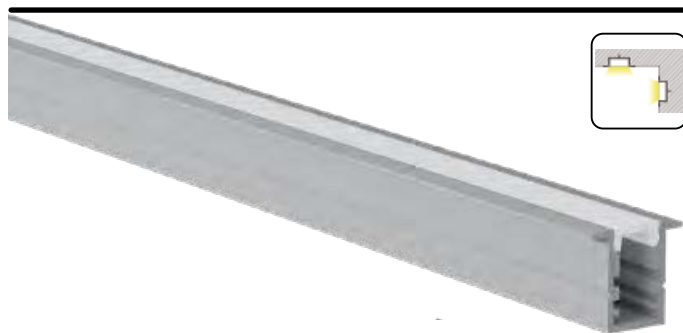

Perfil fabricado con aluminio extrusionado y anodizado. Diseñado como disipador de tiras de LED.

Profile made of extruded and anodized aluminium. Designed as a heatsink for LED strips.

Profil fabriqué en aluminium extrudé et anodisé. Conçu comme dissipateur thermique pour les bandes LED.

IP20

Max. w/m
50 W

AL
6063

Cut
to
Size

Plata 2m
Silver 2m
Argent 2m

Ref.: **83260**
PVP: 12,85€

Blanco 2m
White 2m
Blanc 2m

Ref.: **83261**
PVP: 16,10€

Negro 2m
Black 2m
Noir 2m

Ref.: **83262**
PVP: 16,10€

Escala / Scale / Échelle 1:1

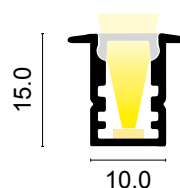
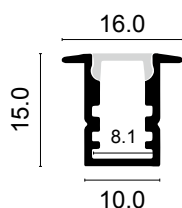

Características técnicas / Technical data / Caractéristiques techniques

Potencia disipada / Power dissipation / Dissipation de puissance	Máx 50 W/M
Aleación de aluminio / Aluminium alloy / Puissance de Roullis	AL 6063
Longitud / Length / Longueur	2 M
IP	20

Difusores / Diffusers / Diffuseurs



PC



PMMA

Referencia Reference Référence	Color Color Couleur	Medida Measure Étendue	PVP
83269	Opal / Opal / Opale	2m	4,95€
83273	Negro / Black / Noir	2m	7,95€

Tapas / Caps / Tapas



Referencia Reference Référence	Color Color Couleur	PVP
83264	Plata / Silver / Argent	
83266	Blanco / White / Blanc	0,50€
83268	Negro / Black / Noir	



Referencia Reference Référence	Color Color Couleur	PVP
83263	Plata / Silver / Argent	
83265	Blanco / White / Blanc	0,50€
83267	Negro / Black / Noir	

Grapas / Staples / Agrafes



Referencia Reference Référence	Color Color Couleur	PVP
83272	Aluminio / Aluminium / Aluminium	0,80€





Perfil fabricado con aluminio extrusionado y anodizado. Diseñado como disipador de tiras de LED.

Profile made of extruded and anodized aluminium. Designed as a heatsink for LED strips.

Profil fabriqué en aluminium extrudé et anodisé. Conçu comme dissipateur thermique pour les bandes LED.

IP20

Max. w/m
50 W

AL
6063

Cut
to
Size

Plata 2m
Silver 2m
Argent 2m

Ref.: **85340**
PVP: 6,75€

Plata 3m
Silver 3m
Argent 3m

Ref.: **85341**
PVP: 10,25€

* Coste de envío de perfil de 3m a consultar en condiciones generales de venta

* Shipping cost of 3m profile to consult in general conditions of sale

* Frais de port du profil 3m à consulter dans les conditions générales de vente

Escala / Scale / Échelle 1:1

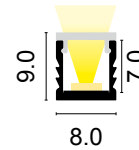
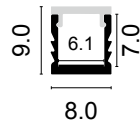

Características técnicas / Technical data / Caractéristiques techniques

Potencia disipada / Power dissipation / Dissipation de puissance	Máx 50 W/M
Aleación de aluminio / Aluminium alloy / Puissance de Roullis	AL 6063
Longitud / Length / Longueur	2 M - 3 M
IP	20

Difusores / Diffusers / Diffuseurs



Referencia Reference Référence	Color Color Couleur	Medida Measure Étendue	PVP
85606	Opal / Opal / Opale	2m	5,95€
85607	Opal / Opal / Opale	3m	8,95€

Tapas / Caps / Tapas



Referencia Reference Référence	Color Color Couleur	PVP
85245	Plata / Silver / Argent	2,15€





Perfil fabricado con aluminio extrusionado y anodizado. Diseñado como disipador de tiras de LED.

Profile made of extruded and anodized aluminium. Designed as a heatsink for LED strips.

Profil fabriqué en aluminium extrudé et anodisé. Conçu comme dissipateur thermique pour les bandes LED.

IP20

Max. w/m
50 W

AL
6063

Cut
to
Size

● Plata 2,02m
Silver 2,02m
Argent 2,02m

Ref.: **86160**
PVP: 10,25€

○ Blanco 2,02m
White 2,02m
Blanc 2,02m

Ref.: **86161**
PVP: 12,75€

● Negro 2,02m
Black 2,02m
Noir 2,02m

Ref.: **86162**
PVP: 12,75€

Escala / Scale / Échelle 1:1

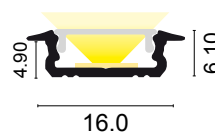
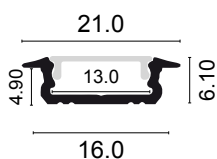

Características técnicas / Technical data / Caractéristiques techniques

Potencia disipada / Power dissipation / Dissipation de puissance	Máx 50 W/M
Aleación de aluminio / Aluminium alloy / Puissance de Roulis	AL 6063
Longitud / Length / Longueur	2,02 M
IP	20

Difusores / Diffusers / Diffuseurs



Referencia Reference Référence	Color Color Couleur	Medida Measure Étendue	PVP
86090	Opal / Opal / Opale	2,02m	5,95€
86091	Opal / Opal / Opale	Al corte	3,45€/M
86092	Negro / Black / Noir	2,02m	6,95€
86093	Negro / Black / Noir	Al corte	4,45€/M

Tapas / Caps / Tapas



Referencia Reference Référence	Color Color Couleur	PVP
86163	Plata / Silver / Argent	
86165	Blanco / White / Blanc	0,85€
86167	Negro / Black / Noir	





Perfil fabricado con aluminio extrusionado y anodizado. Diseñado como disipador de tiras de LED.

Profile made of extruded and anodized aluminium. Designed as a heatsink for LED strips.

Profil fabriqué en aluminium extrudé et anodisé. Conçu comme dissipateur thermique pour les bandes LED.

IP20

Max. w/m
50 W

AL
6063

Cut
to
Size

●
Plata 2m
Silver 2m
Argent 2m

Ref.: **83150**
PVP: 10,45€

○
Blanco 2m
White 2m
Blanc 2m

Ref.: **83151**
PVP: 12,95€

●
Negro 2m
Black 2m
Noir 2m

Ref.: **83152**
PVP: 12,95€

Escala / Scale / Échelle 1:1

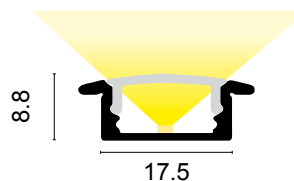
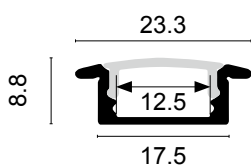

Características técnicas / Technical data / Caractéristiques techniques

Potencia disipada / Power dissipation / Dissipation de puissance	Máx 50 W/M
Aleación de aluminio / Aluminium alloy / Puissance de Roulis	AL 6063
Longitud / Length / Longueur	2 M
IP	20

Difusores / Diffusers / Diffuseurs

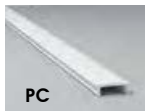

Referencia Reference Référence	Color Color Couleur	Medida Measure Étendue	PVP
83159	Opal / Opal / Opale	2m	6,95€
83165	Opal / Opal / Opale	Al corte	3,95€/M
83163	Negro / Black / Noir	2m	7,95€
83166	Negro / Black / Noir	Al corte	4,95€/M

Tapas / Caps / Tapas



Referencia Reference Référence	Color Color Couleur	PVP
83154	Plata / Silver / Argent	
83156	Blanco / White / Blanc	0,50€
83158	Negro / Black / Noir	

Referencia Reference Référence	Color Color Couleur	PVP
83153	Plata / Silver / Argent	
83155	Blanco / White / Blanc	0,50€
83157	Negro / Black / Noir	

Grapas / Staples / Agrafes



Referencia Reference Référence	Color Color Couleur	PVP
83162	Aluminio / Aluminium / Aluminium	0,80€





Perfil fabricado con aluminio extrusionado y anodizado. Diseñado como disipador de tiras de LED.

Profile made of extruded and anodized aluminium. Designed as a heatsink for LED strips.

Profil fabriqué en aluminium extrudé et anodisé. Conçu comme dissipateur thermique pour les bandes LED.

IP20

Max. w/m
50 W

AL
6063

Cut
to
Size

Plata 2,02m
Silver 2,02m
Argent 2,02m

Ref.: **86180**
PVP: 12,45€

Blanco 2,02m
White 2,02m
Blanc 2,02m

Ref.: **86181**
PVP: 16,45€

Negro 2,02m
Black 2,02m
Noir 2,02m

Ref.: **86182**
PVP: 16,45€

Escala / Scale / Échelle 1:1

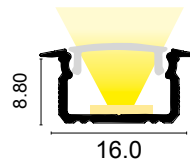
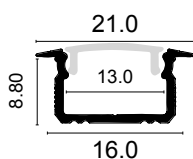

Características técnicas / Technical data / Caractéristiques techniques

Potencia disipada / Power dissipation / Dissipation de puissance	Máx 50 W/M
Aleación de aluminio / Aluminium alloy / Puissance de Roulis	AL 6063
Longitud / Length / Longueur	2,02 M
IP	20

Difusores / Diffusers / Diffuseurs



Referencia Reference Référence	Color Color Couleur	Medida Measure Etendue	PVP
86090	Opal / Opal / Opale	2,02m	5,95€
86091	Opal / Opal / Opale	Al corte	3,45€/M
86092	Negro / Black / Noir	2,02m	6,95€
86093	Negro / Black / Noir	Al corte	4,45€/M

Tapas / Caps / Tapas



Referencia Reference Référence	Color Color Couleur	PVP
86183	Plata / Silver / Argent	0,85€
86185	Blanco / White / Blanc	
86187	Negro / Black / Noir	





Perfil fabricado con aluminio extrusionado y anodizado. Diseñado como disipador de tiras de LED.

Profile made of extruded and anodized aluminium. Designed as a heatsink for LED strips.

Profil fabriqué en aluminium extrudé et anodisé. Conçu comme dissipateur thermique pour les bandes LED.

IP20

Max. w/m
50 W

AL
6063

Cut
to
Size

Plata 2m
Silver 2m
Argent 2m

Ref.: **83340**
PVP: 25,95€

Blanco 2m
White 2m
Blanc 2m

Ref.: **83341**
PVP: 28,80€

Negro 2m
Black 2m
Noir 2m

Ref.: **83342**
PVP: 28,80€

Escala / Scale / Échelle 1:1

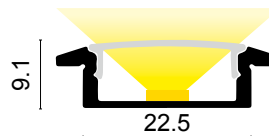
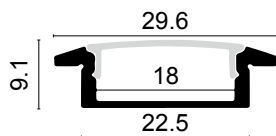



Características técnicas / Technical data / Caractéristiques techniques

Potencia disipada / Power dissipation / Dissipation de puissance	Máx 50 W/M
Aleación de aluminio / Aluminium alloy / Puissance de Roulis	AL 6063
Longitud / Length / Longueur	2 M
IP	20

Difusores / Diffusers / Diffuseurs



Referencia Reference Référence	Color Color Couleur	Medida Measure Étendue	PVP
83349	Opal / Opal / Opale	2m	9,25€
83355	Opal / Opal / Opale	Al corte 	5,95€/M
83352	Negro / Black / Noir	2m	13,95€
83356	Negro / Black / Noir	Al corte 	8,95€/M

Tapas / Caps / Tapas



Referencia Reference Référence	Color Color Couleur	PVP
83344	Plata / Silver / Argent	
83346	Blanco / White / Blanc	0,65€
83348	Negro / Black / Noir	



Referencia Reference Référence	Color Color Couleur	PVP
83343	Plata / Silver / Argent	
83345	Blanco / White / Blanc	0,65€
83347	Negro / Black / Noir	

Grapas / Staples / Agrafes



Referencia Reference Référence	Color Color Couleur	PVP
83351	Aluminio / Aluminium / Aluminium	0,85€

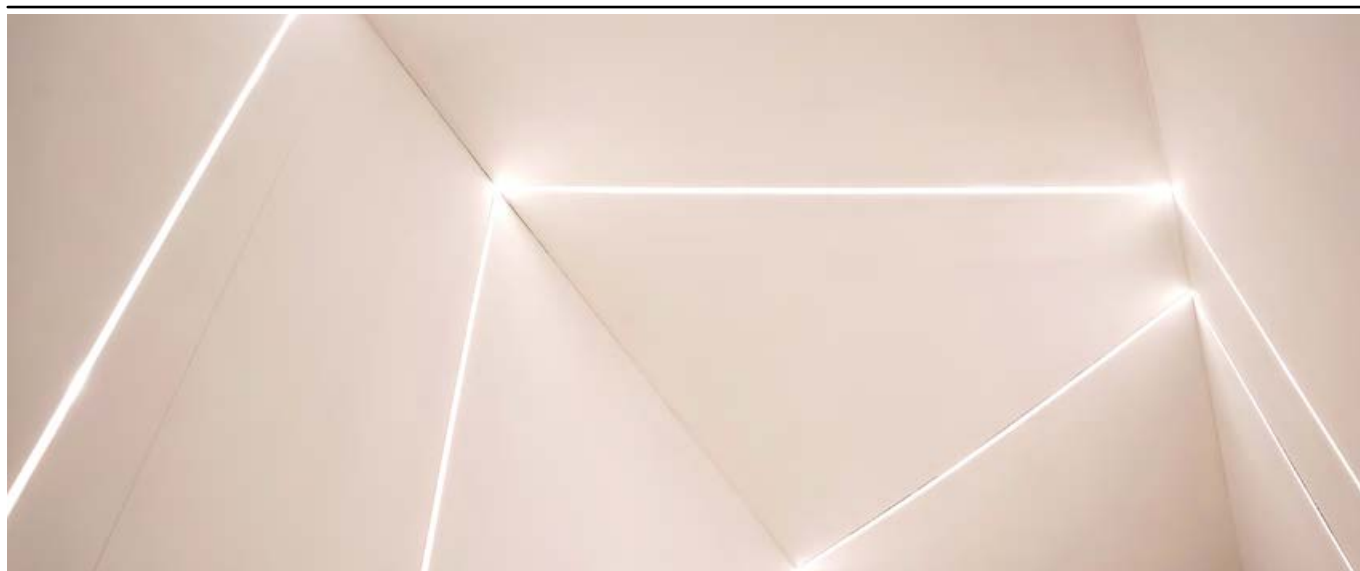

DAKAR Perfil empotrar / Recessed profile / Profilé encastré



Perfil fabricado con aluminio extrusionado y anodizado. Diseñado como disipador de tiras de LED.

Profile made of extruded and anodized aluminium. Designed as a heatsink for LED strips.

Profil fabriqué en aluminium extrudé et anodisé. Conçu comme dissipateur thermique pour les bandes LED.

● Plata 2m
Silver 2m
Argent 2m

Ref.: **83130**
PVP: 18,50€

○ Blanco 2m
White 2m
Blanc 2m

Ref.: **83131**
PVP: 19,95€

● Negro 2m
Black 2m
Noir 2m

Ref.: **83132**
PVP: 19,95€

IP20

Max. w/m
50 W

AL
6063

Cut
to
Size

Escala / Scale / Échelle 1:1

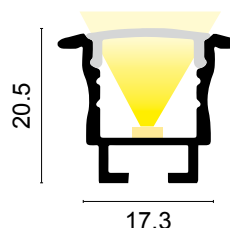
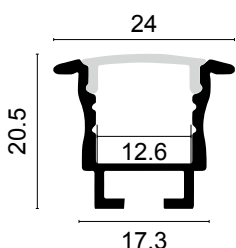

Características técnicas / Technical data / Caractéristiques techniques

Potencia disipada / Power dissipation / Dissipation de puissance	Máx 50 W/M
Aleación de aluminio / Aluminium alloy / Puissance de Roullis	AL 6063
Longitud / Length / Longueur	2 M
IP	20

Difusores / Diffusers / Diffuseurs



Referencia Reference Référence	Color Color Couleur	Medida Measure Étendue	PVP
83139	Opal / Opal / Opale	2m	6,95€
83145	Opal / Opal / Opale	Al corte	3,95€/M
83143	Negro / Black / Noir	2m	7,95€
83146	Negro / Black / Noir	Al corte	5,95€/M

Tapas / Caps / Tapas



Referencia Reference Référence	Color Color Couleur	PVP
83134	Plata / Silver / Argent	0,80€
83136	Blanco / White / Blanc	
83138	Negro / Black / Noir	

Referencia Reference Référence	Color Color Couleur	PVP
83133	Plata / Silver / Argent	0,80€
83135	Blanco / White / Blanc	
83137	Negro / Black / Noir	

Grapas / Staples / Agrafes



Referencia Reference Référence	Color Color Couleur	PVP
83142	Aluminio / Aluminium / Aluminium	3,95€



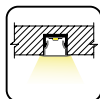

Perfil fabricado con aluminio extrusionado y anodizado. Diseñado como disipador de tiras de LED.

Profile made of extruded and anodized aluminium. Designed as a heatsink for LED strips.

Profil fabriqué en aluminium extrudé et anodisé. Conçu comme dissipateur thermique pour les bandes LED.

IP20

Max. w/m
50 W

AL
6063

Cut
to
Size



Plata 2m
Silver 2m
Argent 2m

Ref.: **83580**
PVP: 13,90€



Blanco 2m
White 2m
Blanc 2m

Ref.: **83581**
PVP: 17,15€



Negro 2m
Black 2m
Noir 2m

Ref.: **83582**
PVP: 17,15€

Escala / Scale / Échelle 1:1

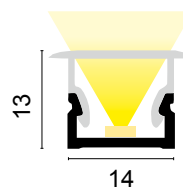
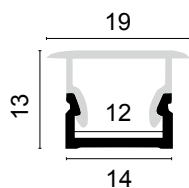

Características técnicas / Technical data / Caractéristiques techniques

Potencia disipada / Power dissipation / Dissipation de puissance	Máx 50 W/M
Aleación de aluminio / Aluminium alloy / Puissance de Roulis	AL 6063
Longitud / Length / Longueur	2 M
IP	20

Difusores / Diffusers / Diffuseurs



Referencia Reference Référence	Color Color Couleur	Medida Measure Étendue	PVP
83589	Opal / Opal / Opale	2m	9,60€
83590	Negro / Black / Noir	2m	12,85€

Tapas / Caps / Tapas



Referencia Reference Référence	Color Color Couleur	PVP
83584	Plata / Silver / Argent	
83586	Blanco / White / Blanc	0,65€
83588	Negro / Black / Noir	



Referencia Reference Référence	Color Color Couleur	PVP
83583	Plata / Silver / Argent	
83585	Blanco / White / Blanc	0,65€
83587	Negro / Black / Noir	



BASILEA Perfil empotrar / Recessed profile / Profilé encastré



Perfil fabricado con aluminio extrusionado y anodizado. Diseñado como disipador de tiras de LED.

Profile made of extruded and anodized aluminium. Designed as a heatsink for LED strips.

Profil fabriqué en aluminium extrudé et anodisé. Conçu comme dissipateur thermique pour les bandes LED.

IP20

Max. w/m
50 W

AL
6063

Cut
to
Size

●
Plata 2,02m
Silver 2,02m
Argent 2,02m

Ref.: **86200**
PVP: 15,95€

○
Blanco 2,02m
White 2,02m
Blanc 2,02m

Ref.: **86201**
PVP: 19,45€

●
Negro 2,02m
Black 2,02m
Noir 2,02m

Ref.: **86202**
PVP: 19,45€

Escala / Scale / Échelle 1:1

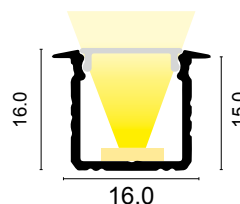
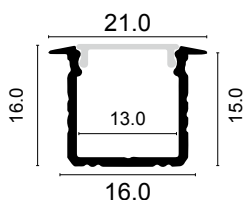

Características técnicas / Technical data / Caractéristiques techniques

Potencia disipada / Power dissipation / Dissipation de puissance	Máx 50 W/M
Aleación de aluminio / Aluminium alloy / Puissance de Roullis	AL 6063
Longitud / Length / Longueur	2,02 M
IP	20

Difusores / Diffusers / Diffuseurs



Referencia Reference Référence	Color Color Couleur	Medida Measure Étendue	PVP
86090	Opal / Opal / Opale	2,02m	5,95€
86091	Opal / Opal / Opale	Al corte	3,45€
86092	Negro / Black / Noir	2,02m	6,95€
86093	Negro / Black / Noir	Al corte	4,45€

Tapas / Caps / Tapas



Referencia Reference Référence	Color Color Couleur	PVP
86203	Plata / Silver / Argent	
86205	Blanco / White / Blanc	1,95€
86207	Negro / Black / Noir	





Perfil fabricado con aluminio extrusionado y anodizado. Diseñado como disipador de tiras de LED.

Profile made of extruded and anodized aluminium. Designed as a heatsink for LED strips.

Profil fabriqué en aluminium extrudé et anodisé. Conçu comme dissipateur thermique pour les bandes LED.

IP20

Max. w/m
50 W

AL
6063

Cut
to
Size



Plata 2m
Silver 2m
Argent 2m

Ref.: **85370**
PVP: 20,95€



Blanco 2m
White 2m
Blanc 2m

Ref.: **85371**
PVP: 22,45€



Negro 2m
Black 2m
Noir 2m

Ref.: **85372**
PVP: 22,45€

Escala / Scale / Échelle 1:1

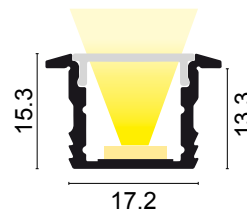
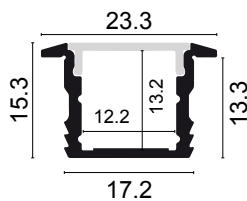

Características técnicas / Technical data / Caractéristiques techniques

Potencia disipada / Power dissipation / Dissipation de puissance	Máx 50 W/M
Aleación de aluminio / Aluminium alloy / Puissance de Roullis	AL 6063
Longitud / Length / Longueur	2 M
IP	20

Difusores / Diffusers / Diffuseurs



Referencia Reference Référence	Color Color Couleur	Medida Measure Étendue	PVP
85161	Opal / Opal / Opale	2m	7,95€
85612	Negro / Black / Noir	2m	12,95€

Tapas / Caps / Tapas



Referencia Reference Référence	Color Color Couleur	PVP
85377	Plata / Silver / Argent	
85379	Blanco / White / Blanc	0,60€
85381	Negro / Black / Noir	



Referencia Reference Référence	Color Color Couleur	PVP
85376	Plata / Silver / Argent	
85378	Blanco / White / Blanc	0,60€
85380	Negro / Black / Noir	





Perfil fabricado con aluminio extrusionado y anodizado. Diseñado como disipador de tiras de LED.

Profile made of extruded and anodized aluminium. Designed as a heatsink for LED strips.

Profil fabriqué en aluminium extrudé et anodisé. Conçu comme dissipateur thermique pour les bandes LED.

Plata 2m
Silver 2m
Argent 2m

Ref.: **85350**
PVP: 17,95€

IP20

Max. w/m
50 W

AL
6063

Cut
to
Size

Escala / Scale / Échelle 1:1

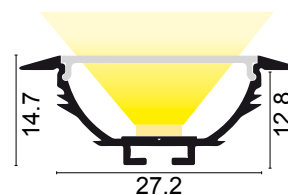
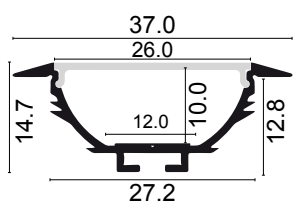

Características técnicas / Technical data / Caractéristiques techniques

Potencia disipada / Power dissipation / Dissipation de puissance	Máx 50 W/M
Aleación de aluminio / Aluminium alloy / Puissance de Roulis	AL 6063
Longitud / Length / Longueur	2 M
IP	20

Difusores / Diffusers / Diffuseurs



Referencia Reference Référence	Color Color Couleur	Medida Measure Étendue	PVP
85618	Opal / Opal / Opale	2m	10,95€

Tapas / Caps / Tapas



Referencia Reference Référence	Color Color Couleur	PVP
85357	Plata / Silver / Argent	0,60€

Grapas / Staples / Agrafes



Referencia Reference Référence	Color Color Couleur	PVP
85164	Aluminio / Aluminium / Aluminium	0,95€
85650	Aluminio / Aluminium / Aluminium	4,25€



Referencia Reference Référence	Color Color Couleur	PVP
85356	Plata / Silver / Argent	0,60€





Perfil fabricado con aluminio extrusionado y anodizado. Diseñado como disipador de tiras de LED.

Profile made of extruded and anodized aluminium. Designed as a heatsink for LED strips.

Profil fabriqué en aluminium extrudé et anodisé. Conçu comme dissipateur thermique pour les bandes LED.

IP20

Max. w/m
50 W

AL
6063

Cut
to
Size

● Plata 2m
● Silver 2m
● Argent 2m
Ref.: **85390**
PVP: 21,95€

○ Blanco 2m
○ White 2m
○ Blanc 2m
Ref.: **85391**
PVP: 22,95€

Escala / Scale / Échelle 1:1

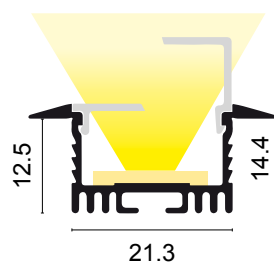
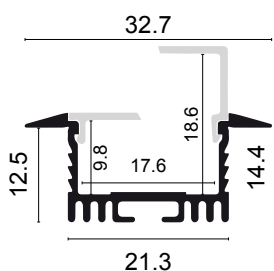

Características técnicas / Technical data / Caractéristiques techniques

Potencia disipada / Power dissipation / Dissipation de puissance	Máx 50 W/M
Aleación de aluminio / Aluminium alloy / Puissance de Roulis	AL 6063
Longitud / Length / Longueur	2 M
IP	20

Difusores / Diffusers / Diffuseurs



Referencia Reference Référence	Color Color Couleur	Medida Measure Étendue	PVP
85602	Opal / Opal / Opale	2m	8,25€
85600	Opal / Opal / Opale	2m	11,95€

Tapas / Caps / Tapas



Referencia Reference Référence	Color Color Couleur	PVP
85396	Plata / Silver / Argent	1,45€



Referencia Reference Référence	Color Color Couleur	PVP
85660	Plata / Silver / Argent	1,45€



Grapas / Staples / Agrafes



Referencia Reference Référence	Color Color Couleur	PVP
85650	Aluminio / Aluminium / Aluminium	4,25€



Perfil fabricado con aluminio extrusionado y anodizado. Diseñado como disipador de tiras de LED.

Profile made of extruded and anodized aluminium. Designed as a heatsink for LED strips.

Profil fabriqué en aluminium extrudé et anodisé. Conçu comme dissipateur thermique pour les bandes LED.



Plata 2m
Silver 2m
Argent 2m

Ref.: **85410**
PVP: 25,95€

IP20

Max. w/m
50 W

AL
6063

Cut
to
Size

Escala / Scale / Échelle 1:1

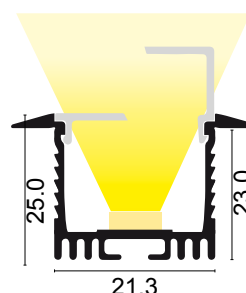
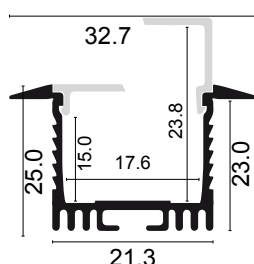

Características técnicas / Technical data / Caractéristiques techniques

Potencia disipada / Power dissipation / Dissipation de puissance	Máx 50 W/M
Aleación de aluminio / Aluminium alloy / Puissance de Roulis	AL 6063
Longitud / Length / Longueur	2 M
IP	20

Difusores / Diffusers / Diffuseurs



Referencia Reference Référence	Color Color Couleur	PVP
85602	Opal / Opal / Opale	8,25€
85600	Opal / Opal / Opale	11,95€

Grapas / Staples / Agrafes



Referencia Reference Référence	Color Color Couleur	PVP
85650	Aluminio / Aluminium / Aluminium	4,25€

Tapas / Caps / Tapas



Referencia Reference Référence	Color Color Couleur	PVP
85413	Plata / Silver / Argent	1,45€



Referencia Reference Référence	Color Color Couleur	PVP
85660	Plata / Silver / Argent	1,45€



LINZ Perfil empotrar / Recessed profile / Profilé encastré

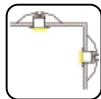

Perfil fabricado con aluminio extrusionado y anodizado. Diseñado como disipador de tiras de LED.

Profile made of extruded and anodized aluminium. Designed as a heatsink for LED strips.

Profil fabriqué en aluminium extrudé et anodisé. Conçu comme dissipateur thermique pour les bandes LED.



Plata 2m
Silver 2m
Argent 2m

Ref.: **83600**
PVP: 45,95€



Blanco 2m
White 2m
Blanc 2m

Ref.: **83601**
PVP: 52,65€



Negro 2m
Black 2m
Noir 2m

Ref.: **83602**
PVP: 52,65€

IP20

Max. w/m
100 W

AL
6063

Cut
to
Size

Escala / Scale / Échelle 1:1

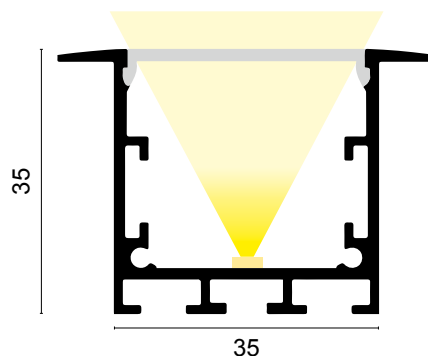
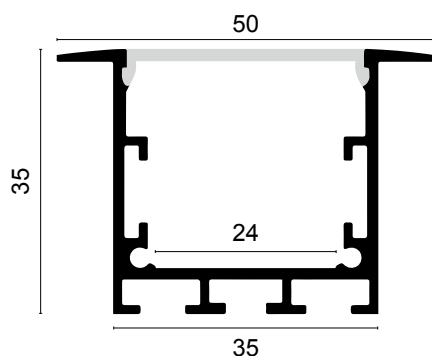

Características técnicas / Technical data / Caractéristiques techniques

Potencia disipada / Power dissipation / Dissipation de puissance	Máx 100 W/M
Aleación de aluminio / Aluminium alloy / Puissance de Roullis	AL 6063
Longitud / Length / Longueur	2 M
IP	20

Difusores / Diffusers / Diffuseurs



Referencia Reference Référence	Color Color Couleur	Medida Measure Étendue	PVP
83609	Opal / Opal / Opale	2m	9,95€
83615	Opal / Opal / Opale	Al corte	5,95€/M
83610	Negro / Black / Noir	2m	13,90€
83616	Negro / Black / Noir	Al corte	7,95€/M

Grapas / Staples / Agrafes



Referencia Reference Référence	Color Color Couleur	PVP
83142	Aluminio / Aluminium / Aluminium	3,95€

Tapas / Caps / Tapas



Referencia Reference Référence	Color Color Couleur	PVP
83604	Plata / Silver / Argent	
83606	Blanco / White / Blanc	2,10€
83608	Negro / Black / Noir	



Referencia Reference Référence	Color Color Couleur	PVP
83603	Plata / Silver / Argent	
83605	Blanco / White / Blanc	2,10€
83607	Negro / Black / Noir	



PERTH Perfil empotrar / Recessed profile / Profilé encastré

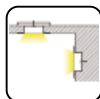

Perfil fabricado con aluminio extrusionado y anodizado. Diseñado como disipador de tiras de LED.

Profile made of extruded and anodized aluminium. Designed as a heatsink for LED strips.

Profil fabriqué en aluminium extrudé et anodisé. Conçu comme dissipateur thermique pour les bandes LED.

Plata 2m
Silver 2m
Argent 2m
Ref.: **83620**
PVP: 69,95€

Blanco 2m
White 2m
Blanc 2m
Ref.: **83621**
PVP: 74,95€

Negro 2m
Black 2m
Noir 2m
Ref.: **83622**
PVP: 74,95€

IP20

Max. w/m
100 W

AL
6063

Cut
to
Size

Escala / Scale / Échelle 1:1

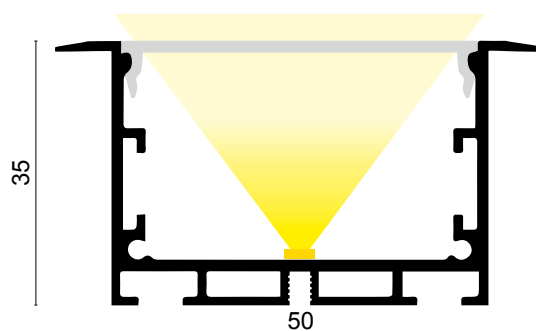
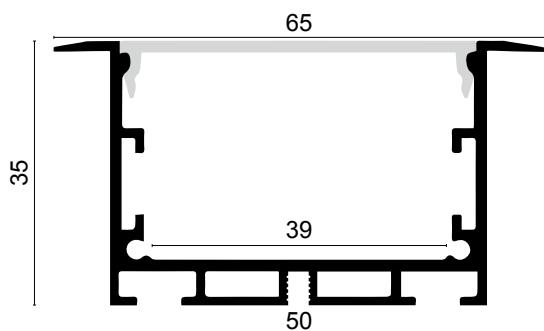

Características técnicas / Technical data / Caractéristiques techniques

Potencia disipada / Power dissipation / Dissipation de puissance	Máx 100 W/M
Aleación de aluminio / Aluminium alloy / Puissance de Roullis	AL 6063
Longitud / Length / Longueur	2 M
IP	20

Difusores / Diffusers / Diffuseurs



Referencia Reference Référence	Color Color Couleur	Medida Measure Étendue	PVP
83629	Opal / Opal / Opale	2m	12,85€
83635	Opal / Opal / Opale	Al corte	7,95€/M
83630	Negro / Black / Noir	2m	16,10€
83636	Negro / Black / Noir	Al corte	9,95€/M

Tapas / Caps / Tapas



Referencia Reference Référence	Color Color Couleur	PVP
83624	Plata / Silver / Argent	
83626	Blanco / White / Blanc	2,10€
83628	Negro / Black / Noir	



Referencia Reference Référence	Color Color Couleur	PVP
83623	Plata / Silver / Argent	
83625	Blanco / White / Blanc	2,10€
83627	Negro / Black / Noir	

Grapas / Staples / Agrafes



Referencia Reference Référence	Color Color Couleur	PVP
83632	Aluminio / Aluminium / Aluminium	5,95€



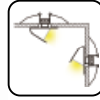

Perfil fabricado con aluminio extrusionado y anodizado. Diseñado como disipador de tiras de LED.

Profile made of extruded and anodized aluminium. Designed as a heatsink for LED strips.

Profil fabriqué en aluminium extrudé et anodisé. Conçu comme dissipateur thermique pour les bandes LED.



Blanco 2m
White 2m
Blanc 2m

Ref.: **83171**
PVP: 39,95€

IP20

Max. w/m
50 W

AL
6063

Cut
to
Size

Escala / Scale / Échelle 1:1

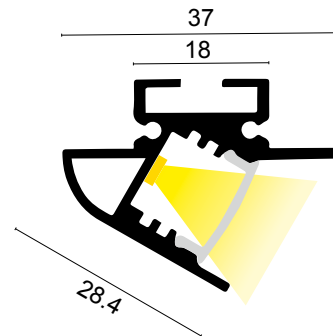
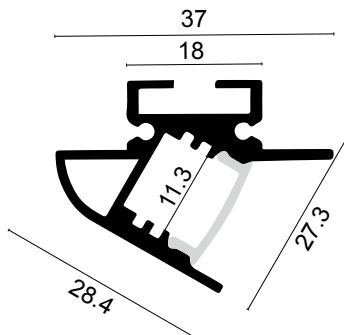

Características técnicas / Technical data / Caractéristiques techniques

Potencia disipada / Power dissipation / Dissipation de puissance	Máx 50 W/M
Aleación de aluminio / Aluminium alloy / Puissance de Roulis	AL 6063
Longitud / Length / Longueur	2 M
IP	20

Difusores / Diffusers / Diffuseurs



Referencia Reference Référence	Color Color Couleur	Medida Measure Etendue	PVP
83179	Opal / Opal / Opale	2m	6,95€

Tapas / Caps / Tapas



Referencia Reference Référence	Color Color Couleur	PVP
83176	Blanco / White / Blanc	0,50€

Grapas / Staples / Agrafes



Referencia Reference Référence	Color Color Couleur	PVP
83142	Aluminio / Aluminium / Aluminium	3,95€



Referencia Reference Référence	Color Color Couleur	PVP
83175	Blanco / White / Blanc	0,50€



VOLGA Perfil empotrar / Recessed profile / Profilé encastré



Perfil fabricado con aluminio extrusionado y anodizado. Diseñado como disipador de tiras de LED.

Profile made of extruded and anodized aluminium. Designed as a heatsink for LED strips.

Profil fabriqué en aluminium extrudé et anodisé. Conçu comme dissipateur thermique pour les bandes LED.



Plata 3m
Silver 3m
Argent 3m

***Sellado IP65 para perfil estanco**
**IP65 sealing for watertight profile*
**Étanchéité IP65 pour profil étanche*

Ref.: **85110**
PVP: 21,95€

Ref.: **90040**
PVP: 15,95€

IP20

IP65

Max. w/m
50 W

AL
6063

Cut
to
Size

* Coste de envío de perfil de 3m a consultar en condiciones generales de venta
* Shipping cost of 3m profile to consult in general conditions of sale
* Frais de port du profil 3m à consulter dans les conditions générales de vente

Escala / Scale / Échelle 1:1

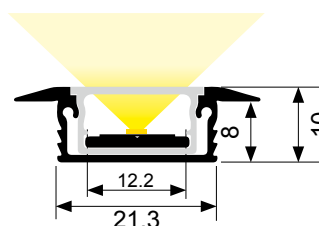
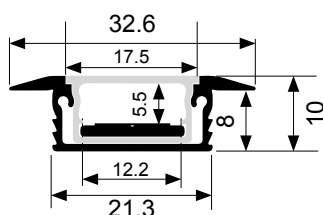

Características técnicas / Technical data / Caractéristiques techniques

Potencia disipada / Power dissipation / Dissipation de puissance	Máx 50 W/M
Aleación de aluminio / Aluminium alloy / Puissance de Roullis	AL 6063
Longitud / Length / Longueur	3M
IP	65

Pletina / Platen / Platine

Referencia Reference Référence	Color Color Couleur	Medida Measure Étendue	PVP
85136	Opal / Opal / Opale	3m	8,95€

Tapas / Caps / Tapas

Referencia Reference Référence	Color Color Couleur	PVP
85111	Gris / Grey / Gris	0,50€

Difusores / Diffusers / Diffuseurs

Referencia Reference Référence	Color Color Couleur	Medida Measure Étendue	PVP
85107	Opal / Opal / Opale	3m	16,95€

Referencia Reference Référence	Color Color Couleur	PVP
85108	Blanco / White / Blanc	1,45€

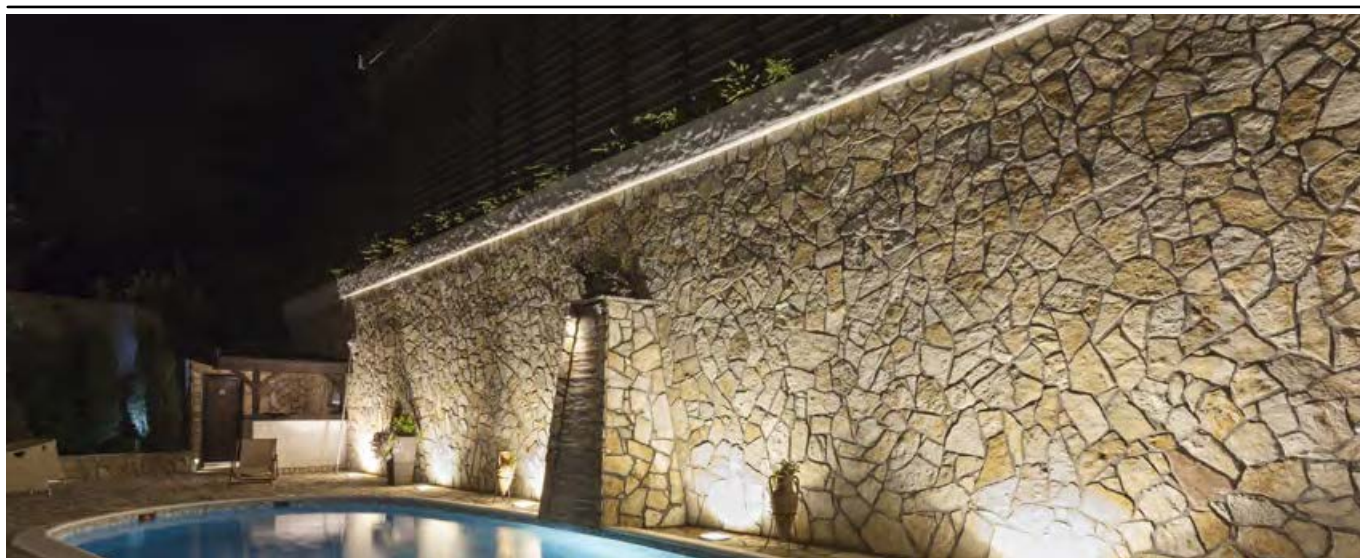



Perfil fabricado con aluminio extrusionado y anodizado. Diseñado como disipador de tiras de LED.

Profile made of extruded and anodized aluminium. Designed as a heatsink for LED strips.

Profil fabriqué en aluminium extrudé et anodisé. Conçu comme dissipateur thermique pour les bandes LED.

IP20

IP 65

Max. w/m
50 W

AL
6063

Cut
to
Size

Plata 3m
Silver 3m
Argent 3m

***Sellado IP65 para perfil estanco**
**IP65 sealing for watertight profile*
**Étanchéité IP65 pour profil étanche*

Ref.: **85130**
PVP: 26,95€

Ref.: **90040**
PVP: 15,95€

* Coste de envío de perfil de 3m a consultar en condiciones generales de venta
* Shipping cost of 3m profile to consult in general conditions of sale
* Frais de port du profil 3m à consulter dans les conditions générales de vente

Escala / Scale / Échelle 1:1

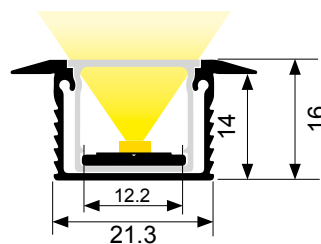
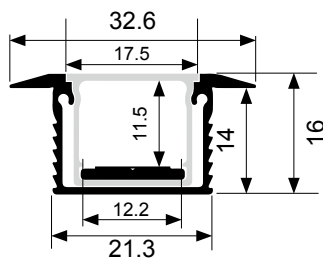

Características técnicas / Technical data / Caractéristiques techniques

Potencia disipada / Power dissipation / Dissipation de puissance	Máx 50 W/M
Aleación de aluminio / Aluminium alloy / Puissance de Roullis	AL 6063
Longitud / Length / Longueur	3M
IP	65

Pletina / Platen / Platine

Referencia Reference Référence	Color Color Couleur	Medida Measure Étendue	PVP
85136	Opal / Opal / Opale	3m	8,95€

Tapas / Caps / Tapas



Referencia Reference Référence	Color Color Couleur	PVP
85131	Gris / Grey / Gris	0,50€

Difusores / Diffusers / Diffuseurs



Referencia Reference Référence	Color Color Couleur	Medida Measure Étendue	PVP
85127	Opal / Opal / Opale	3m	22,95€



Referencia Reference Référence	Color Color Couleur	PVP
85128	Blanco / White / Blanc	1,45€





LYOPRO

LED PROFILE

Perfil Arquitectónico
Architectural Profile
Profilé architectural

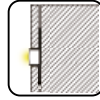

Perfil fabricado con aluminio extrusionado y anodizado. Diseñado como disipador de tiras de LED.

Profile made of extruded and anodized aluminium. Designed as a heatsink for LED strips.

Profil fabriqué en aluminium extrudé et anodisé.

Conçu comme dissipateur thermique pour les bandes LED.



Blanco 2m
White 2m
Blanc 2m

Ref.: **83001**
PVP: 26,85€

IP20

Max. w/m
50 W

AL
6063

Cut
to
Size

Escala / Scale / Échelle 1:1

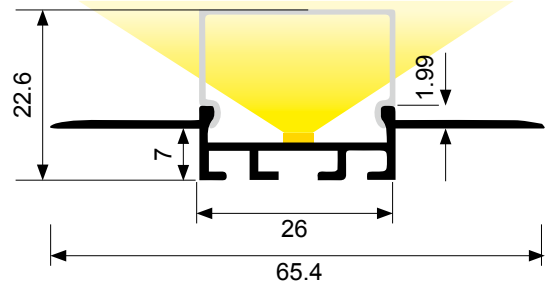
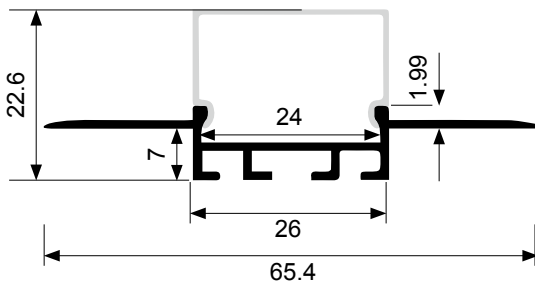
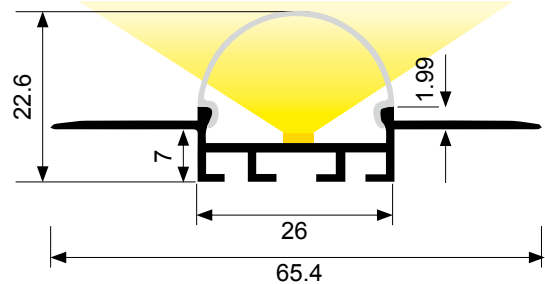
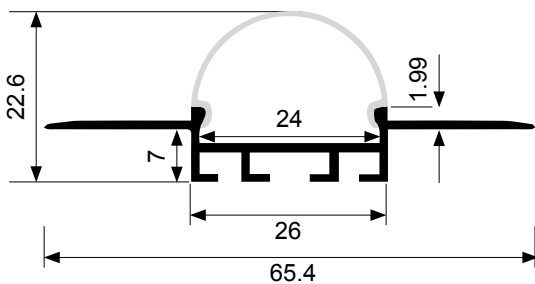

Características técnicas / Technical data / Caractéristiques techniques

Potencia disipada / Power dissipation / Dissipation de puissance	Máx 50 W/M
Aleación de aluminio / Aluminium alloy / Puissance de Roulis	AL 6063
Longitud / Length / Longueur	2 M
IP	20

Difusores / Diffusers / Diffuseurs



Referencia Reference Référence	Forma Shape Forme	Color Color Couleur	Medida Measure Étendue	PVP
83015	Curva / Curve / Courbe	Opal / Opal / Opale	2m	6,45€
83018	Cuadrada / Square / Carré	Opal / Opal / Opale	2m	6,45€

Tapas / Caps / Tapas



Referencia Reference Référence	Forma Shape Forme	Color Color Couleur	PVP
83006	Curva / Curve / Courbe	Plata / Silver / Argent	0,50€

Referencia Reference Référence	Forma Shape Forme	Color Color Couleur	PVP
83012	Cuadrada / Square / Carré	Plata / Silver / Argent	0,50€

Referencia Reference Référence	Forma Shape Forme	Color Color Couleur	PVP
83005	Curva / Curve / Courbe	Plata / Silver / Argent	0,50€

Referencia Reference Référence	Forma Shape Forme	Color Color Couleur	PVP
83011	Cuadrada / Square / Carré	Plata / Silver / Argent	0,50€

Grapas / Staples / Agrafes



Referencia Reference Référence	Color Color Couleur	PVP
83142	Aluminio / Aluminium / Aluminium	3,95€

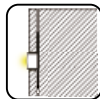
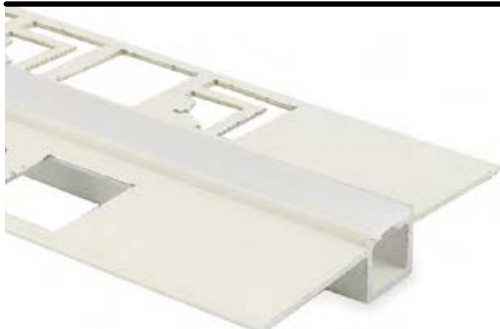

Perfil fabricado con aluminio extrusionado y anodizado. Diseñado como disipador de tiras de LED.

Profile made of extruded and anodized aluminium. Designed as a heatsink for LED strips.

Profil fabriqué en aluminium extrudé et anodisé. Conçu comme dissipateur thermique pour les bandes LED.



Blanco 3m
White 3m
Blanc 3m

Ref.: **85420**
PVP: 28,95€

IP20

Max. w/m
50 W

AL
6063

Cut
to
Size

* Coste de envío de perfil de 3m a consultar en condiciones generales de venta

* Shipping cost of 3m profile to consult in general conditions of sale

* Frais de port du profil 3m à consulter dans les conditions générales de vente

Escala / Scale / Échelle 1:1

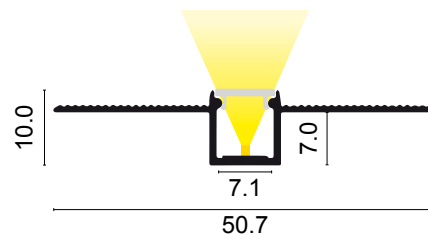
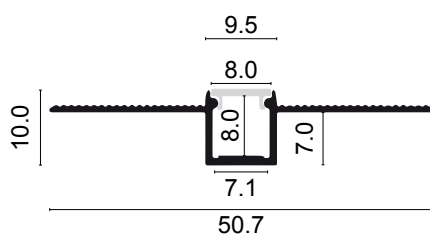

Características técnicas / Technical data / Caractéristiques techniques

Potencia disipada / Power dissipation / Dissipation de puissance	Máx 50 W/M
Aleación de aluminio / Aluminium alloy / Puissance de Roulis	AL 6063
Longitud / Length / Longueur	3 M
IP	20

Difusores / Diffusers / Diffuseurs



Referencia Reference Référence	Color Color Couleur	Medida Measure Étendue	PVP
85607	Opal / Opal / Opale	3m	8,95€



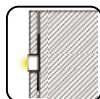
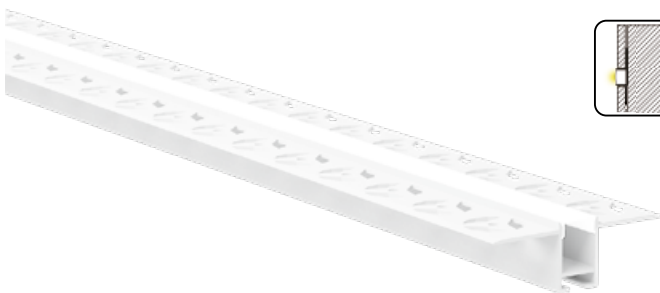

Perfil fabricado con aluminio extrusionado y anodizado. Diseñado como disipador de tiras de LED.

Profile made of extruded and anodized aluminium. Designed as a heatsink for LED strips.

Profil fabriqué en aluminium extrudé et anodisé. Conçu comme dissipateur thermique pour les bandes LED.

○
Blanco 2m
White 2m
Blanc 2m

Ref.: **83031**
PVP: 26,85€

IP20

Max. w/m
50 W

AL
6063

Cut
to
Size

Escala / Scale / Échelle 1:1

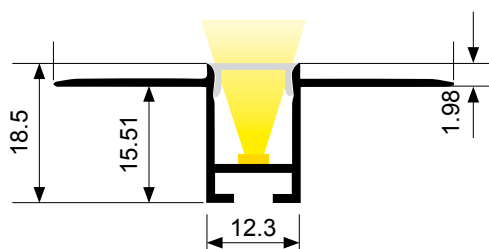
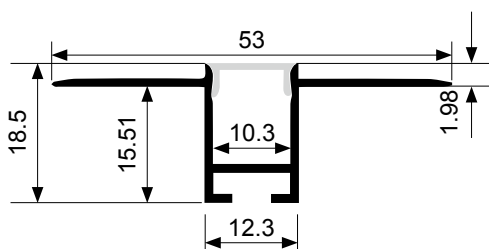

Características técnicas / Technical data / Caractéristiques techniques

Potencia disipada / Power dissipation / Dissipation de puissance	Máx 50 W/M
Aleación de aluminio / Aluminium alloy / Puissance de Roulis	AL 6063
Longitud / Length / Longueur	2 M
IP	20

Difusores / Diffusers / Diffuseurs



Referencia Reference Référence	Color Color Couleur	Medida Measure Étendue	PVP
83039	Opal / Opal / Opale	2m	5,45€

Tapas / Caps / Tapas



Referencia Reference Référence	Color Color Couleur	PVP
83036	Blanco / White / Blanc	0,50€



Referencia Reference Référence	Color Color Couleur	PVP
83035	Blanco / White / Blanc	0,50€

Grapas / Staples / Agrafes



Referencia Reference Référence	Color Color Couleur	PVP
83142	Aluminio / Aluminium / Aluminium	3,95€



LUGO Perfil arquitectónico / Architectural profile / Profilé architectural

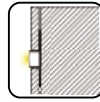
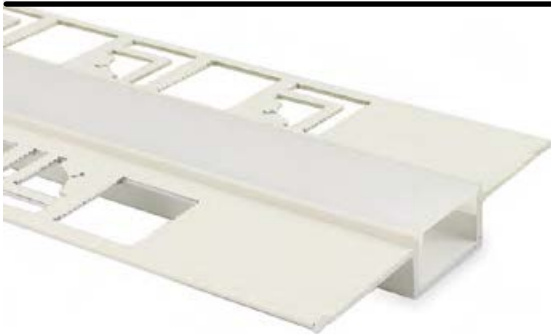

Perfil fabricado con aluminio extrusionado y anodizado. Diseñado como disipador de tiras de LED.

Profile made of extruded and anodized aluminium. Designed as a heatsink for LED strips.

Profil fabriqué en aluminium extrudé et anodisé. Conçu comme dissipateur thermique pour les bandes LED.



Blanco 3m
White 3m
Blanc 3m

Ref.: **85431**
PVP: 65,10€

IP20

Max. w/m
50 W

AL
6063

Cut
to
Size

* Coste de envío de perfil de 3m a consultar en condiciones generales de venta

* Shipping cost of 3m profile to consult in general conditions of sale

* Frais de port du profil 3m à consulter dans les conditions générales de vente

Escala / Scale / Échelle 1:1

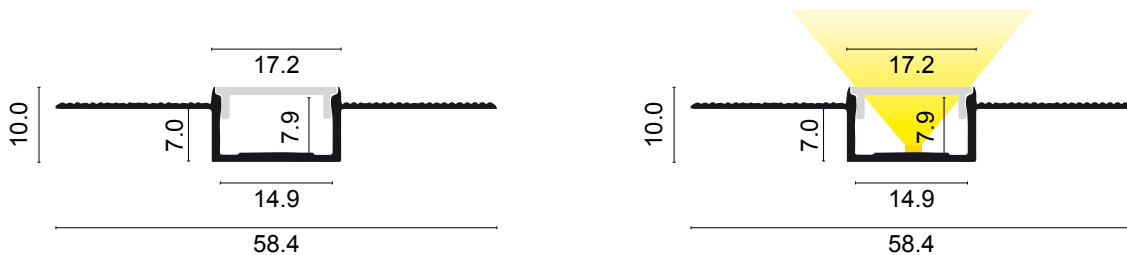

Características técnicas / Technical data / Caractéristiques techniques

Potencia disipada / Power dissipation / Dissipation de puissance	Máx 50 W/M
Aleación de aluminio / Aluminium alloy / Puissance de Roulis	AL 6063
Longitud / Length / Longueur	3 M
IP	20

Difusores / Diffusers / Diffuseurs



Referencia Reference Référence	Color Color Couleur	Medida Measure Étendue	PVP
85198	Opal / Opal / Opale	3m	10,45€

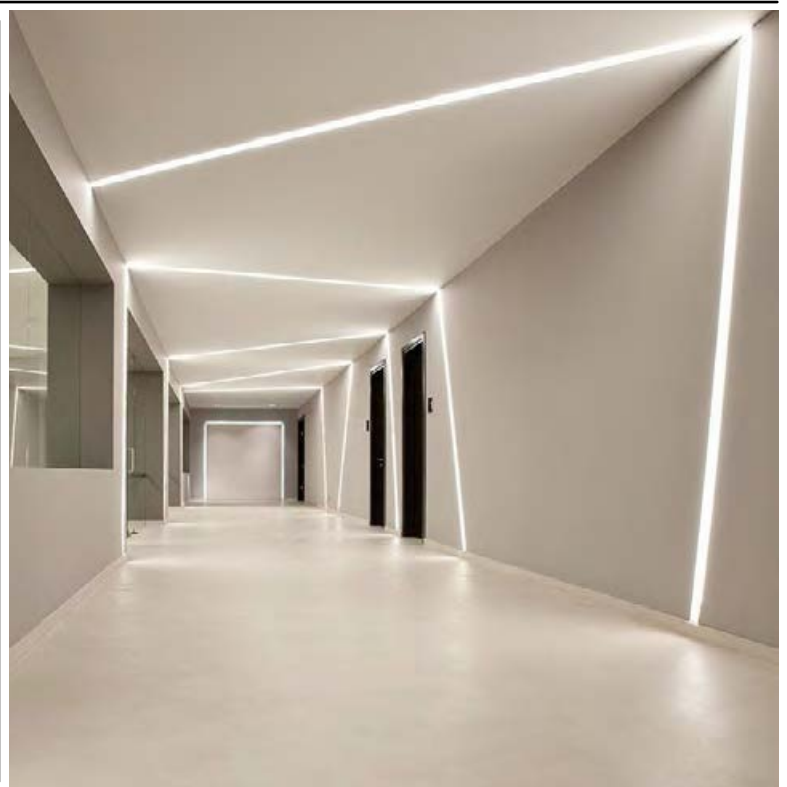

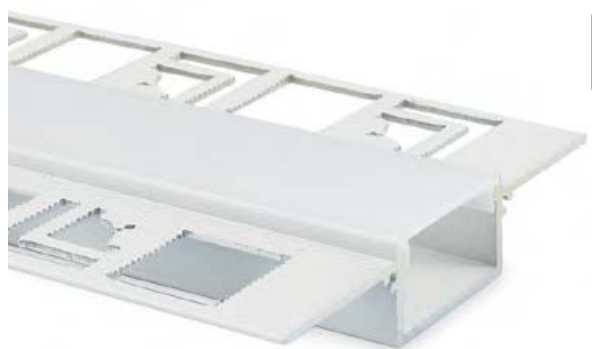

Perfil fabricado con aluminio extrusionado y anodizado. Diseñado como disipador de tiras de LED.

Profile made of extruded and anodized aluminium. Designed as a heatsink for LED strips.

Profil fabriqué en aluminium extrudé et anodisé. Conçu comme dissipateur thermique pour les bandes LED.

Blanco 2m
White 2m
Blanc 2m

Ref.: **85440**
PVP: 45,95€

IP20

Max. w/m
50 W

AL
6063

Cut
to
Size

Escala / Scale / Échelle 1:1

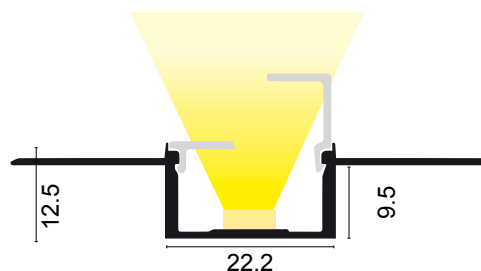
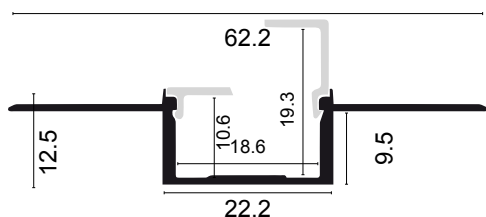

Características técnicas / Technical data / Caractéristiques techniques

Potencia disipada / Power dissipation / Dissipation de puissance	Máx 50 W/M
Aleación de aluminio / Aluminium alloy / Puissance de Roulis	AL 6063
Longitud / Length / Longueur	2 M
IP	20

Difusores / Diffusers / Diffuseurs



Referencia Référence	Color Couleur	Medida Measure Étendue	PVP
85602	Opal / Opal / Opale	2m	8,25€
85600	Opal / Opal / Opale	2m	11,95€

Tapas / Caps / Tapas



Referencia Référence	Color Couleur	PVP
85444	Plata / Silver / Argent	5,95€



Referencia Référence	Color Couleur	PVP
85660	Blanco / White / Blanc	1,45€



SURAT Perfil arquitectónico / Architectural profile / Profilé architectural

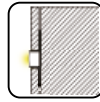

Perfil fabricado con aluminio extrusionado y anodizado. Diseñado como disipador de tiras de LED.

Profile made of extruded and anodized aluminium. Designed as a heatsink for LED strips.

Profil fabriqué en aluminium extrudé et anodisé. Conçu comme dissipateur thermique pour les bandes LED.



Blanco 3m
White 3m
Blanc 3m

Ref.: 85450
PVP: 79,95€

IP20

Max. w/m
50 W

AL
6063

Cut
to
Size

* Coste de envío de perfil de 3m a consultar en condiciones generales de venta
* Shipping cost of 3m profile to consult in general conditions of sale
* Frais de port du profil 3m à consulter dans les conditions générales de vente

Escala / Scale / Échelle 1:1

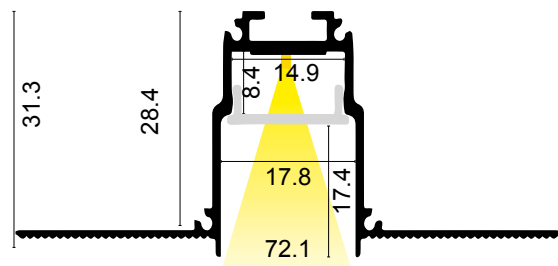
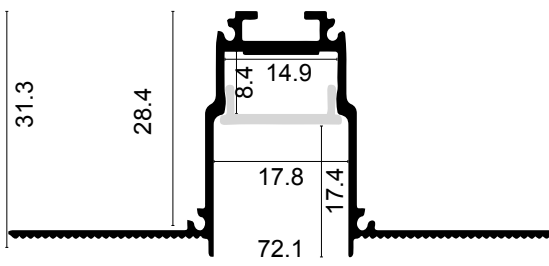

Características técnicas / Technical data / Caractéristiques techniques

Potencia disipada / Power dissipation / Dissipation de puissance	Máx 50 W/M
Aleación de aluminio / Aluminium alloy / Puissance de Roulis	AL 6063
Longitud / Length / Longueur	3 M
IP	20

Difusores / Diffusers / Diffuseurs



Referencia Reference Référence	Color Color Couleur	Medida Measure Étendue	PVP
85198	Opal / Opal / Opale	3m	10,45€

Tapas / Caps / Tapas



Referencia Reference Référence	Color Color Couleur	PVP
85454	Plata / Silver / Argent	5,95€





Perfil fabricado con aluminio extrusionado y anodizado. Diseñado como disipador de tiras de LED.

Profile made of extruded and anodized aluminium. Designed as a heatsink for LED strips.

Profil fabriqué en aluminium extrudé et anodisé. Conçu comme dissipateur thermique pour les bandes LED.



Plata 3m
Silver 3m
Argent 3m

Ref.: **85460**
PVP: 29,95€

IP20

Max. w/m
50 W

AL
6063

Cut
to
Size

* Coste de envío de perfil de 3m a consultar en condiciones generales de venta

* Shipping cost of 3m profile to consult in general conditions of sale

* Frais de port du profil 3m à consulter dans les conditions générales de vente

Escala / Scale / Échelle 1:1

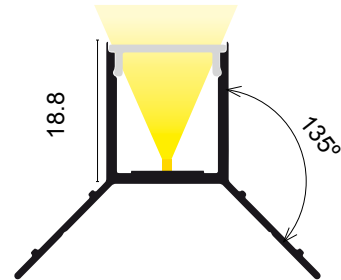
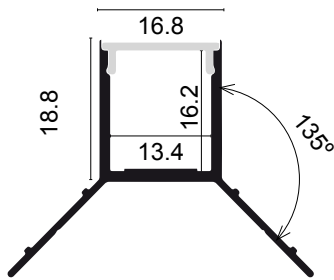

Características técnicas / Technical data / Caractéristiques techniques

Potencia disipada / Power dissipation / Dissipation de puissance	Máx 50 W/M
Aleación de aluminio / Aluminium alloy / Puissance de Roulis	AL 6063
Longitud / Length / Longueur	3 M
IP	20

Difusores / Diffusers / Diffuseurs



Referencia Reference Référence	Color Color Couleur	Medida Measure Étendue	PVP
85198	Opal / Opal / Opale	3m	10,45€





Perfil fabricado con aluminio extrusionado y anodizado. Diseñado como disipador de tiras de LED.

Profile made of extruded and anodized aluminium. Designed as a heatsink for LED strips.

Profil fabriqué en aluminium extrudé et anodisé. Conçu comme dissipateur thermique pour les bandes LED.



Plata 2m
Silver 2m
Argent 2m

Ref.: **85470**
PVP: 29,95€

IP20

Max. w/m
50 W

AL
6063

Cut
to
Size

Escala / Scale / Échelle 1:1

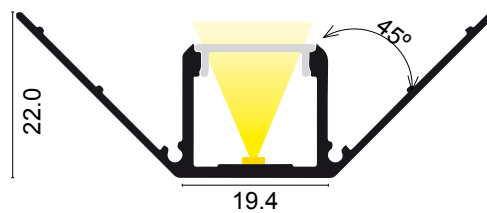
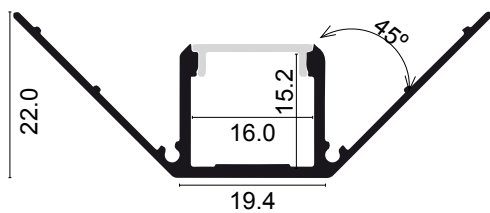

Características técnicas / Technical data / Caractéristiques techniques

Potencia disipada / Power dissipation / Dissipation de puissance	Máx 50 W/M
Aleación de aluminio / Aluminium alloy / Puissance de Roullis	AL 6063
Longitud / Length / Longueur	2 M
IP	20

Difusores / Diffusers / Diffuseurs



Referencia Reference Référence	Color Color Couleur	Medida Measure Étendue	PVP
85161	Opal / Opal / Opale	3m	7,95€



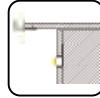

Perfil fabricado con aluminio extrusionado y anodizado. Diseñado como disipador de tiras de LED.

Profile made of extruded and anodized aluminium. Designed as a heatsink for LED strips.

Profil fabriqué en aluminium extrudé et anodisé. Conçu comme dissipateur thermique pour les bandes LED.



Plata 2m
Silver 2m
Argent 2m

Ref.: **83710**
PVP: 21,45€



Blanco 2m
White 2m
Blanc 2m

Ref.: **83711**
PVP: 27,90€



Negro 2m
Black 2m
Noir 2m

Ref.: **83712**
PVP: 27,90€

IP20

Max. w/m
50 W

AL
6063

Cut
to
Size

Escala / Scale / Échelle 1:1

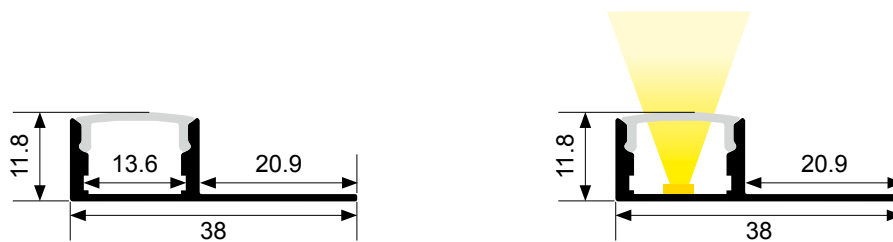

Características técnicas / Technical data / Caractéristiques techniques

Potencia disipada / Power dissipation / Dissipation de puissance	Máx 50 W/M
Aleación de aluminio / Aluminium alloy / Puissance de Roulis	AL 6063
Longitud / Length / Longueur	2 M
IP	20

Difusores / Diffusers / Diffuseurs



Referencia Reference Référence	Color Color Couleur	Medida Measure Étendue	PVP
83719	Opal / Opal / Opale	2m	6,40€
83720	Negro / Black / Noir	2m	7,45€

Tapas / Caps / Tapas



Referencia Reference Référence	Color Color Couleur	PVP
83714	Plata / Silver / Argent	
83716	Blanco / White / Blanc	0,65€
83718	Negro / Black / Noir	

Referencia Reference Référence	Color Color Couleur	PVP
83713	Plata / Silver / Argent	
83715	Blanco / White / Blanc	0,65€
83717	Negro / Black / Noir	





Perfil fabricado con aluminio extrusionado y anodizado. Diseñado como disipador de tiras de LED.

Profile made of extruded and anodized aluminium. Designed as a heatsink for LED strips.

Profil fabriqué en aluminium extrudé et anodisé. Conçu comme dissipateur thermique pour les bandes LED.



Blanco 3m
White 3m
Blanc 3m

Ref.: **85050**
PVP: 33,90€

IP20

Max. w/m
50 W

AL
6063

Cut
to
Size

* Coste de envío de perfil de 3m a consultar en condiciones generales de venta

* Shipping cost of 3m profile to consult in general conditions of sale

* Frais de port du profil 3m à consulter dans les conditions générales de vente

Escala / Scale / Échelle 1:1

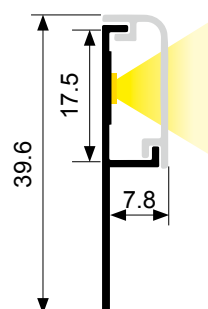
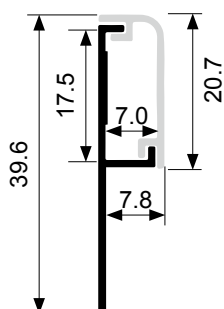

Características técnicas / Technical data / Caractéristiques techniques

Potencia disipada / Power dissipation / Dissipation de puissance	Máx 50 W/M
Aleación de aluminio / Aluminium alloy / Puissance de Roulis	AL 6063
Longitud / Length / Longueur	3 M
IP	20

Difusores / Diffusers / Diffuseurs



Referencia Reference Référence	Color Color Couleur	Medida Measure Étendue	PVP
85051	Opal / Opal / Opale	3m	17,95€





Perfil fabricado con aluminio extrusionado y anodizado. Diseñado como disipador de tiras de LED.

Profile made of extruded and anodized aluminium. Designed as a heatsink for LED strips.

Profil fabriqué en aluminium extrudé et anodisé. Conçu comme dissipateur thermique pour les bandes LED.

IP20

Max. w/m
50 W

AL
6063

Cut
to
Size



Plata 3m
Silver 3m
Argent 3m

Ref.: **85480**
PVP: 29,95€



Blanco 3m
White 3m
Blanc 3m

Ref.: **85481**
PVP: 30,95€

* Coste de envío de perfil de 3m a consultar en condiciones generales de venta

* Shipping cost of 3m profile to consult in general conditions of sale

* Frais de port du profil 3m à consulter dans les conditions générales de vente

Escala / Scale / Échelle 1:1

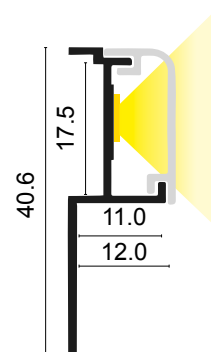
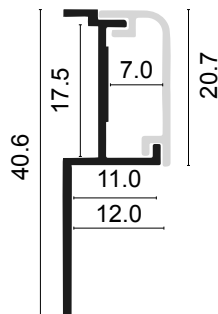

Características técnicas / Technical data / Caractéristiques techniques

Potencia disipada / Power dissipation / Dissipation de puissance	Máx 50 W/M
Aleación de aluminio / Aluminium alloy / Puissance de Roulis	AL 6063
Longitud / Length / Longueur	3 M
IP	20

Difusores / Diffusers / Diffuseurs



Referencia Reference Référence	Color Color Couleur	Medida Measure Étendue	PVP
85051	Opal / Opal / Opale	3m	17,95€





Perfil fabricado con aluminio extrusionado y anodizado. Diseñado como disipador de tiras de LED.

Profile made of extruded and anodized aluminium. Designed as a heatsink for LED strips.

Profil fabriqué en aluminium extrudé et anodisé. Conçu comme dissipateur thermique pour les bandes LED.



Plata 2m
Silver 2m
Argent 2m

Ref.: **85060**
PVP: 40,15€



Negro 2m
Black 2m
Noir 2m

Ref.: **85062**
PVP: 45,00€

IP20

Max. w/m
50 W

AL
6063

Cut
to
Size

Escala / Scale / Échelle 1:1

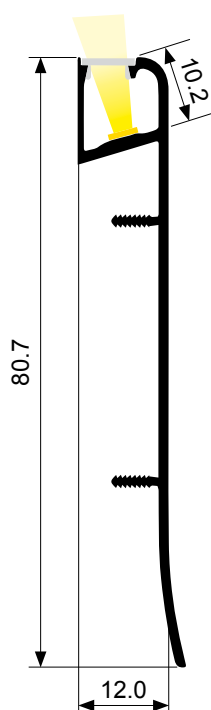
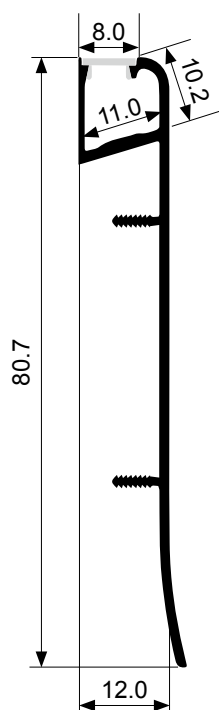

Características técnicas / Technical data / Caractéristiques techniques

Potencia disipada / Power dissipation / Dissipation de puissance	Máx 50 W/M
Aleación de aluminio / Aluminium alloy / Puissance de Roulis	AL 6063
Longitud / Length / Longueur	2 M
IP	20

Difusores / Diffusers / Diffuseurs



Referencia Reference Référence	Color Color Couleur	Medida Measure Étendue	PVP
85606	Opal / Opal / Opale	2m	5,95€

Tapas / Caps / Tapas



Referencia Reference Référence	Color Color Couleur	PVP
85064	Blanco / White / Blanc	5,80€



Perfil fabricado con aluminio extrusionado y anodizado. Diseñado como disipador de tiras de LED.

Profile made of extruded and anodized aluminium. Designed as a heatsink for LED strips.

Profil fabriqué en aluminium extrudé et anodisé. Conçu comme dissipateur thermique pour les bandes LED.



Blanco 3m
White 3m
Blanc 3m

Ref.: **85070**
PVP: 54,95€

IP20

Max. w/m
50 W

AL
6063

Cut
to
Size

* Coste de envío de perfil de 3m a consultar en condiciones generales de venta
* Shipping cost of 3m profile to consult in general conditions of sale
* Frais de port du profil 3m à consulter dans les conditions générales de vente

Escala / Scale / Échelle 1:1

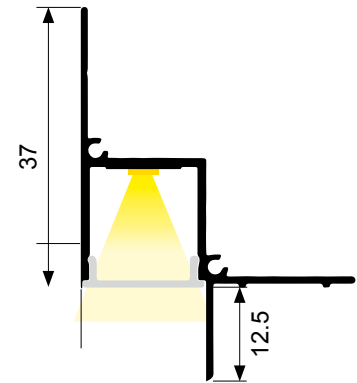
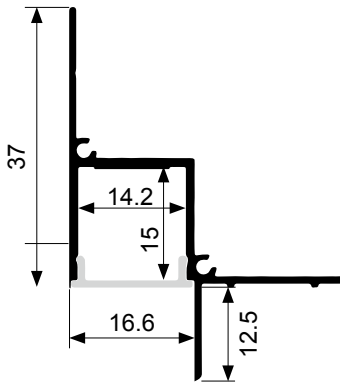

Características técnicas / Technical data / Caractéristiques techniques

Potencia disipada / Power dissipation / Dissipation de puissance	Máx 50 W/M
Aleación de aluminio / Aluminium alloy / Puissance de Roulis	AL 6063
Longitud / Length / Longueur	3 M
IP	20

— **Difusores / Diffusers / Diffuseurs**



Referencia Reference Référence	Color Color Couleur	Medida Measure Étendue	PVP
85198	Opal / Opal / Opale	3m	10,45€

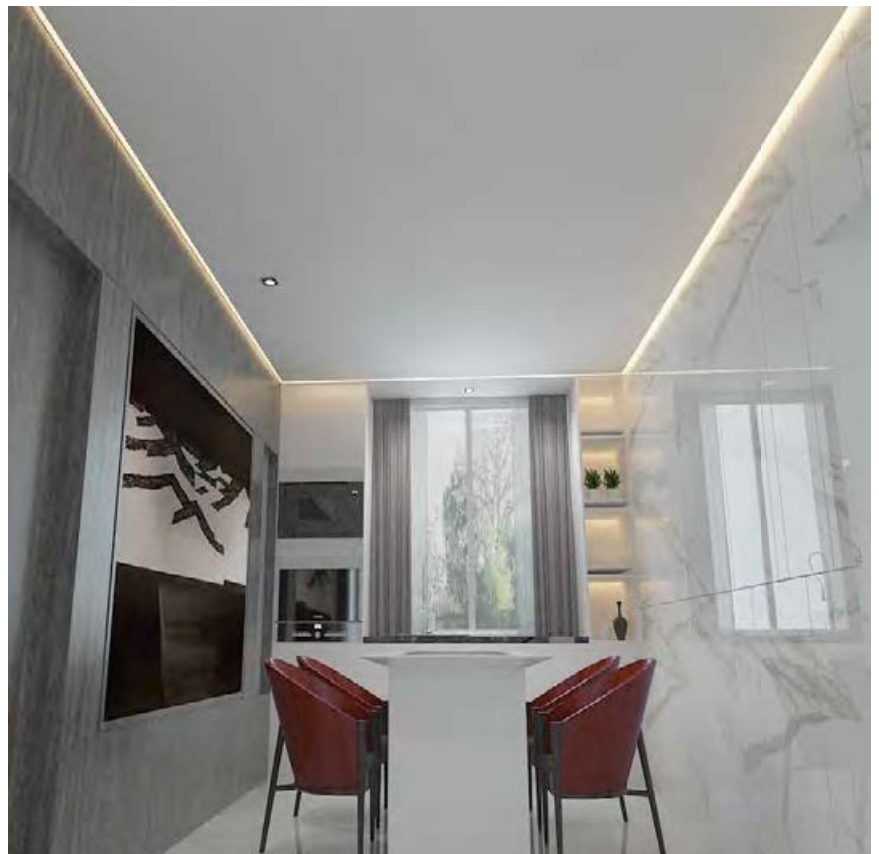

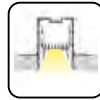

Perfil fabricado con aluminio extrusionado y anodizado. Diseñado como disipador de tiras de LED.

Profile made of extruded and anodized aluminium. Designed as a heatsink for LED strips.

Profil fabriqué en aluminium extrudé et anodisé. Conçu comme dissipateur thermique pour les bandes LED.



Blanco 3m
White 3m
Blanc 3m

Ref.: **85080**
PVP: 119,95€

IP20

Max. w/m
50 W

AL
6063

Cut
to
Size

* Coste de envío de perfil de 3m a consultar en condiciones generales de venta
* Shipping cost of 3m profile to consult in general conditions of sale
* Frais de port du profil 3m à consulter dans les conditions générales de vente

Escala / Scale / Échelle 1:1

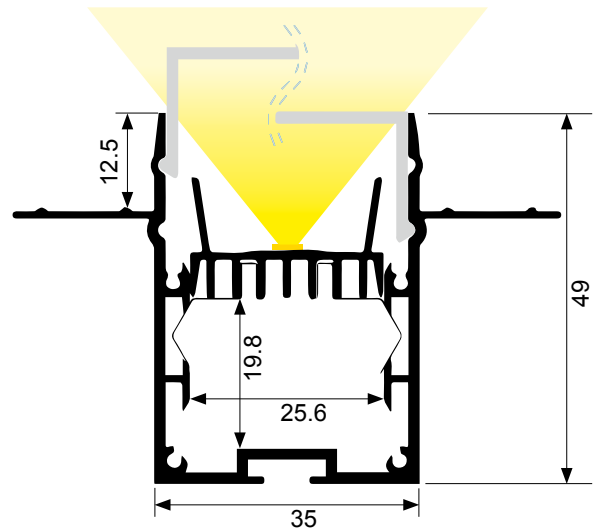
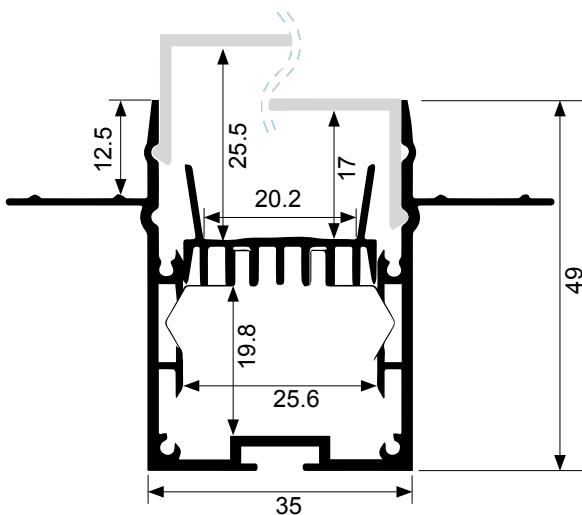

Características técnicas / Technical data / Caractéristiques techniques

Potencia disipada / Power dissipation / Dissipation de puissance	Máx 50 W/M
Aleación de aluminio / Aluminium alloy / Puissance de Roulis	AL 6063
Longitud / Length / Longueur	3 M
IP	20

Difusores / Diffusers / Diffuseurs



Referencia Reference Référence	Color Color Couleur	Medida Measure Etendue	PVP
85082	Opal / Opal / Opale	3m	49,95€

Pletina / Platen / Platine



Referencia Reference Référence	Color Color Couleur	Medida Measure Etendue	PVP
85081	Aluminio / Aluminium / Aluminium	3m	34,85€

Tapas / Caps / Tapas



Referencia Reference Référence	Color Color Couleur	PVP
85083	Aluminio / Aluminium / Aluminium	5,45€

Clip de montaje para disipador Heatsink mounting clip Clip de montage du dissipateur thermique

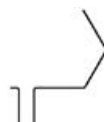

Referencia Reference Référence	Color Color Couleur	PVP
85088	Aluminio / Aluminium / Aluminium	0,75€



Perfil fabricado con aluminio extrusionado y anodizado. Diseñado como disipador de tiras de LED.

Profile made of extruded and anodized aluminium. Designed as a heatsink for LED strips.

Profil fabriqué en aluminium extrudé et anodisé. Conçu comme dissipateur thermique pour les bandes LED.



Blanco 3m
White 3m
Blanc 3m

Ref.: **85090**
PVP: 119,95€

IP20

Max. w/m
50 W

AL
6063

Cut
to
Size

* Coste de envío de perfil de 3m a consultar en condiciones generales de venta
* Shipping cost of 3m profile to consult in general conditions of sale
* Frais de port du profil 3m à consulter dans les conditions générales de vente

Escala / Scale / Échelle 1:1

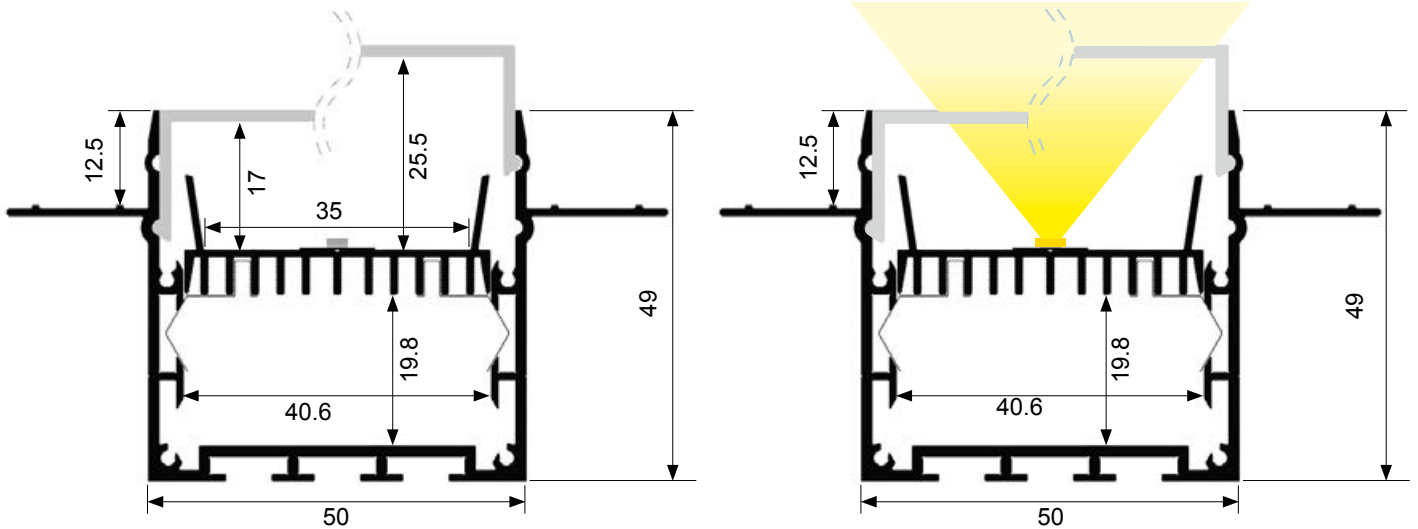

Características técnicas / Technical data / Caractéristiques techniques

Potencia disipada / Power dissipation / Dissipation de puissance	Máx 50 W/M
Aleación de aluminio / Aluminium alloy / Puissance de Roulis	AL 6063
Longitud / Length / Longueur	3 M
IP	20

Difusores / Diffusers / Diffuseurs



Referencia Reference Référence	Color Color Couleur	Medida Measure Etendue	PVP
85092	Opal / Opal / Opale	3m	61,25€

Pletina / Platen / Platine



Referencia Reference Référence	Color Color Couleur	Medida Measure Etendue	PVP
85091	Aluminio / Aluminium / Aluminium	3m	49,95€

Tapas / Caps / Tapas



Referencia Reference Référence	Color Color Couleur	PVP
85093	Aluminio / Aluminium / Aluminium	5,45€

Clip de montaje para disipador
Heatsink mounting clip
Clip de montage du dissipateur thermique



Referencia Reference Référence	Color Color Couleur	PVP
85088	Aluminio / Aluminium / Aluminium	0,75€



Perfil fabricado con aluminio extrusionado y anodizado. Diseñado como disipador de tiras de LED.

Profile made of extruded and anodized aluminium. Designed as a heatsink for LED strips.

Profil fabriqué en aluminium extrudé et anodisé. Conçu comme dissipateur thermique pour les bandes LED.



Plata 3m
Silver 3m
Argent 3m

Ref.: **85150**
PVP: 44,95€

***Sellado IP65 para perfil estanco**
*IP65 sealing for watertight profile
*Étanchéité IP65 pour profil étanche

Ref.: **90040**
PVP: 15,95€

IP20

IP65

Max. w/m
50 W

AL
6063

Cut
to
Size

* Coste de envío de perfil de 3m a consultar en condiciones generales de venta
* Shipping cost of 3m profile to consult in general conditions of sale
* Frais de port du profil 3m à consulter dans les conditions générales de vente

Escala / Scale / Échelle 1:1

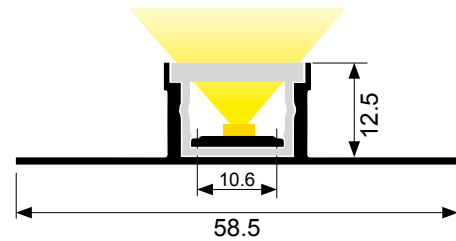
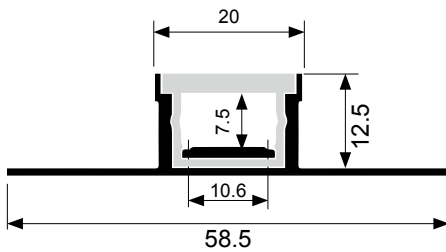

Características técnicas / Technical data / Caractéristiques techniques

Potencia disipada / Power dissipation / Dissipation de puissance	Máx 50 W/M
Aleación de aluminio / Aluminium alloy / Puissance de Roulls	AL 6063
Longitud / Length / Longueur	3M
IP	65

Difusores / Diffusers / Diffuseurs



Referencia Reference Référence	Color Color Couleur	Medida Measure Étendue	PVP
85151	Aluminio / Aluminium / Aluminium	3m	7,25€

Pletina / Platen / Platine



Referencia Reference Référence	Color Color Couleur	Medida Measure Étendue	PVP
85152	Opal / Opal / Opale	3m	33,90€

Tapas / Caps / Tapas



Referencia Reference Référence	Color Color Couleur	PVP
85153	Blanco / White / Blanc	1,45€



LYOPRO
LED PROFILE



Floor Series

BREMEN Perfil de suelo / Soil profile / Profilé du sol

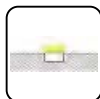

Perfil fabricado con aluminio extrusionado y anodizado. Diseñado como disipador de tiras de LED.

Profile made of extruded and anodized aluminium. Designed as a heatsink for LED strips.

Profil fabriqué en aluminium extrudé et anodisé. Conçu comme dissipateur thermique pour les bandes LED.

Plata 2m
Silver 2m
Argent 2m

Ref.: **83280**
PVP: 13,90€

IP20

Max. w/m
50 W

AL
6063

Cut
to
Size

Escala / Scale / Échelle 1:1

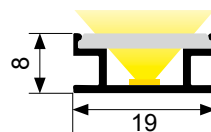
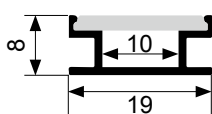

Características técnicas / Technical data / Caractéristiques techniques

Potencia disipada / Power dissipation / Dissipation de puissance	Máx 50 W/M
Aleación de aluminio / Aluminium alloy / Puissance de Roulis	AL 6063
Longitud / Length / Longueur	2 M
IP	20

Difusores / Diffusers / Diffuseurs



Referencia Reference Référence	Color Color Couleur	Medida Measure Étendue	PVP
83289	Opal / Opal / Opale	2m	12,85€

Tapas / Caps / Tapas



Referencia Reference Référence	Color Color Couleur	PVP
83284	Plata / Silver / Argent	0,50€



Referencia Reference Référence	Color Color Couleur	PVP
83283	Plata / Silver / Argent	0,50€



MACAU Perfil de suelo / Soil profile / Profilé du sol



Perfil fabricado con aluminio extrusionado y anodizado. Diseñado como disipador de tiras de LED.

Profile made of extruded and anodized aluminium. Designed as a heatsink for LED strips.

Profil fabriqué en aluminium extrudé et anodisé. Conçu comme dissipateur thermique pour les bandes LED.

● Plata 2m
Silver 2m
Argent 2m
Ref.: **83730**
PVP: 26,85€

○ Blanco 2m
White 2m
Blanc 2m
Ref.: **83731**
PVP: 32,20€

● Negro 2m
Black 2m
Noir 2m
Ref.: **83732**
PVP: 32,20€

IP20

Max. w/m
50 W

AL
6063

Cut
to
Size

Escala / Scale / Échelle 1:1

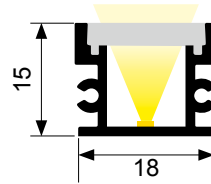
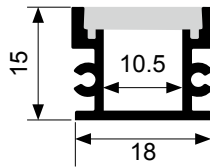

Características técnicas / Technical data / Caractéristiques techniques

Potencia disipada / Power dissipation / Dissipation de puissance	Máx 50 W/M
Aleación de aluminio / Aluminium alloy / Puissance de Roulis	AL 6063
Longitud / Length / Longueur	2 M
IP	20

Difusores / Diffusers / Diffuseurs



Referencia Reference Référence	Color Color Couleur	Medida Measure Etendue	PVP
83739	Opal / Opal / Opale	2m	13,90€
83740	Negro / Black / Noir	2m	16,10€

Tapas / Caps / Tapas



Referencia Reference Référence	Color Color Couleur	PVP
83734	Plata / Silver / Argent	
83736	Blanco / White / Blanc	0,75€
83738	Negro / Black / Noir	

Referencia Reference Référence	Color Color Couleur	PVP
83733	Plata / Silver / Argent	
83735	Blanco / White / Blanc	0,75€
83737	Negro / Black / Noir	



TIGRIS Perfil de suelo / Soil profile / Profilé du sol

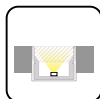

Perfil fabricado con aluminio extrusionado y anodizado. Diseñado como disipador de tiras de LED.

Profile made of extruded and anodized aluminium. Designed as a heatsink for LED strips.

Profil fabriqué en aluminium extrudé et anodisé. Conçu comme dissipateur thermique pour les bandes LED.

IP20



Max. w/m
50 W

AL
6063

Cut
to
Size

○
Blanco 2m
White 2m
Blanc 2m

Ref.: **83560**
PVP: 89,95€

***Sellado IP65 para perfil estanco**
**IP65 sealing for watertight profile*
**Étanchéité IP65 pour profil étanche*

Ref.: **90040**
PVP: 15,95€

Escala / Scale / Échelle 1:1

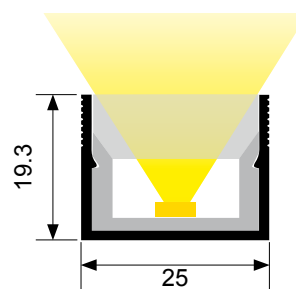
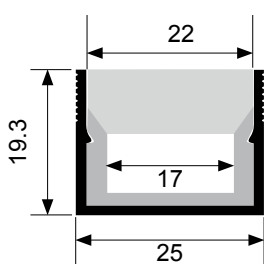

Características técnicas / Technical data / Caractéristiques techniques

Potencia disipada / Power dissipation / Dissipation de puissance	Máx 50 W/M
Aleación de aluminio / Aluminium alloy / Puissance de Roulis	AL 6063
Longitud / Length / Longueur	2 M
IP	65

Pletina / Platen / Platine



Referencia Référence Référence	Color Color Couleur	Medida Measure Étendue	PVP
83534	Aluminio / Aluminium / Aluminium	2m	7,95€





Perfil fabricado con aluminio extrusionado y anodizado. Diseñado como disipador de tiras de LED.

Profile made of extruded and anodized aluminium. Designed as a heatsink for LED strips.

Profil fabriqué en aluminium extrudé et anodisé. Conçu comme dissipateur thermique pour les bandes LED.

IP20

Max. w/m
50 W

AL
6063

Cut
to
Size

Plata 2m
Silver 2m
Argent 2m
Ref.: **83300**
PVP: 26,95€

Negro 2m
Black 2m
Noir 2m
Ref.: **83302**
PVP: 29,95€

Escala / Scale / Échelle 1:1

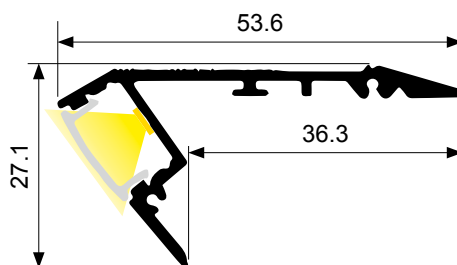
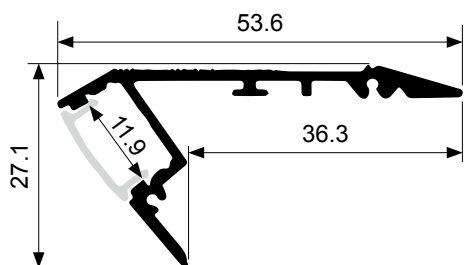

Características técnicas / Technical data / Caractéristiques techniques

Potencia disipada / Power dissipation / Dissipation de puissance	Máx 50 W/M
Aleación de aluminio / Aluminium alloy / Puissance de Roullis	AL 6063
Longitud / Length / Longueur	2 M
IP	20

Difusores / Diffusers / Diffuseurs



Referencia Reference Référence	Color Color Couleur	Medida Measure Étendue	PVP
83309	Opal / Opal / Opale	2m	5,25€
83312	Negro / Black / Noir	2m	7,45€

Tapas / Caps / Tapas



Referencia Reference Référence	Color Color Couleur	PVP
83304	Plata / Silver / Argent	1,30€
83308	Negro / Black / Noir	



Referencia Reference Référence	Color Color Couleur	PVP
83303	Plata / Silver / Argent	1,30€
83307	Negro / Black / Noir	





LYOPRO

LED PROFILE

Perfil Flexible
Flexible Profile
Profilé Souple

OSLO Perfil flexible / Flexible profile / Profilé souple

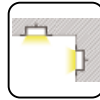
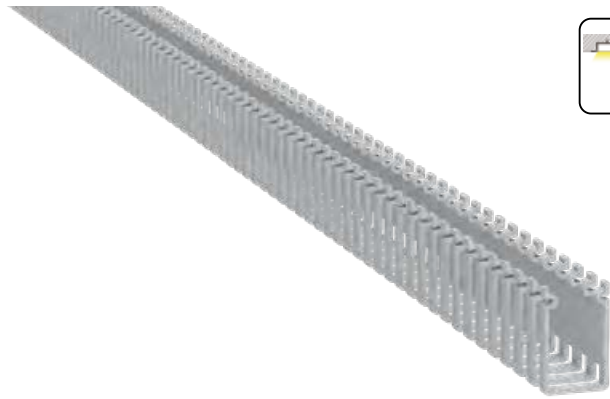

Perfil fabricado con aluminio extrusionado y anodizado. Diseñado como disipador de tiras de LED.

Profile made of extruded and anodized aluminium. Designed as a heatsink for LED strips.

Profil fabriqué en aluminium extrudé et anodisé. Conçu comme dissipateur thermique pour les bandes LED.

○
Blanco 2m
White 2m
Blanc 2m
Ref.: **83391**
PVP: 110,95€

IP20

Max. w/m
50 W

AL
6063

Cut
to
Size

Escala / Scale / Échelle 1:1

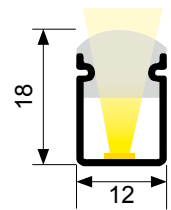
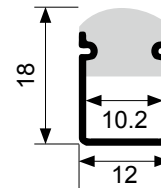
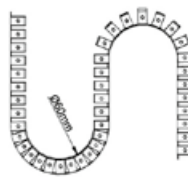
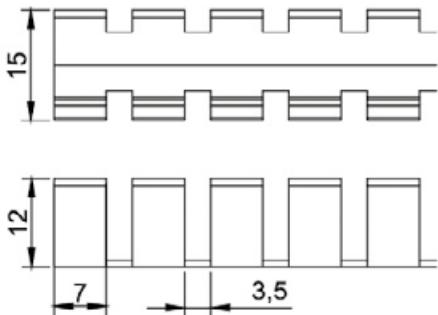

Características técnicas / Technical data / Caractéristiques techniques

Potencia disipada / Power dissipation / Dissipation de puissance	Máx 50 W/M
Aleación de aluminio / Aluminium alloy / Puissance de Roulis	AL 6063
Longitud / Length / Longueur	2 M
IP	20

— Difusores silicona / Silicone diffusers / Diffuseurs en silicone



Referencia Reference Référence	Color Color Couleur	Medida Measure Étendue	PVP
83399	Opal / Opal / Opale	2m	21,45€

— Grapas / Staples / Agrafes —



Referencia Reference Référence	Color Color Couleur	PVP
83402	Aluminio / Aluminium / Aluminium	0,50€

— Tapas / Caps / Tapas —



Referencia Reference Référence	Color Color Couleur	PVP
83395	Blanco / White / Blanc	0,50€



Referencia Reference Référence	Color Color Couleur	PVP
83396	Blanco / White / Blanc	0,50€



NANTES Perfil flexible / Flexible profile / Profilé souple



Perfil fabricado con aluminio extrusionado y anodizado. Diseñado como disipador de tiras de LED.

Profile made of extruded and anodized aluminium. Designed as a heatsink for LED strips.

Profil fabriqué en aluminium extrudé et anodisé. Conçu comme dissipateur thermique pour les bandes LED.

Blanco 2m
White 2m
Blanc 2m

Ref.: **83371**
PVP: 16,45€

IP20

Max. w/m
50 W

AL
6063

Cut
to
Size

Escala / Scale / Échelle 1:1

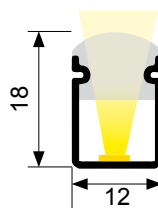
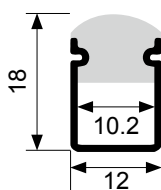

Características técnicas / Technical data / Caractéristiques techniques

Potencia disipada / Power dissipation / Dissipation de puissance	Máx 50 W/M
Aleación de aluminio / Aluminium alloy / Puissance de Roulis	AL 6063
Longitud / Length / Longueur	2 M
IP	20

— Difusores PC / PC diffusers / Diffuseurs PC —



Referencia Reference Référence	Color Color Couleur	Medida Measure Étendue	PVP
83379	Opal / Opal / Opale	2m	21,45€

— Tapas / Caps / Tapas —



Referencia Reference Référence	Color Color Couleur	PVP
83376	Blanco / White / Blanc	0,50€

— Grapas / Staples / Agrafes —



Referencia Reference Référence	Color Color Couleur	PVP
83382	Aluminio / Aluminium / Aluminium	0,50€



Referencia Reference Référence	Color Color Couleur	PVP
83375	Blanco / White / Blanc	0,50€



NIZA Perfil flexible / Flexible profile / Profilé souple

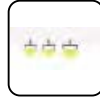

Perfil fabricado con aluminio extrusionado y anodizado. Diseñado como disipador de tiras de LED.

Profile made of extruded and anodized aluminium. Designed as a heatsink for LED strips.

Profil fabriqué en aluminium extrudé et anodisé. Conçu comme dissipateur thermique pour les bandes LED.



Blanco 2m
White 2m
Blanc 2m

Ref.: **83411**
PVP: 8.95€

IP20

Max. w/m
50 W

AL
6063

Cut
to
Size

Escala / Scale / Échelle 1:1

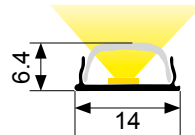
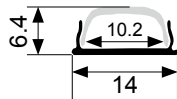

Características técnicas / Technical data / Caractéristiques techniques

Potencia disipada / Power dissipation / Dissipation de puissance	Máx 50 W/M
Aleación de aluminio / Aluminium alloy / Puissance de Roulis	AL 6063
Longitud / Length / Longueur	2 M
IP	20

— Difusores PC / PC diffusers / Diffuseurs PC —



Referencia Reference Référence	Color Color Couleur	Medida Measure Étendue	PVP
83419	Opal / Opal / Opale	2m	6,95€

— Tapas / Caps / Tapas —



Referencia Reference Référence	Color Color Couleur	PVP
83416	Blanco / White / Blanc	0,50€

— Grapas / Staples / Agrafes —



Referencia Reference Référence	Color Color Couleur	PVP
83422	Aluminio / Aluminium / Aluminium	0,50€



Referencia Reference Référence	Color Color Couleur	PVP
83415	Blanco / White / Blanc	0,50€



HAIFA Perfil flexible / Flexible profile / Profilé souple



Perfil fabricado con aluminio extrusionado y anodizado. Diseñado como disipador de tiras de LED.

Profile made of extruded and anodized aluminium. Designed as a heatsink for LED strips.

Profil fabriqué en aluminium extrudé et anodisé. Conçu comme dissipateur thermique pour les bandes LED.

Blanco 2m
White 2m
Blanc 2m

Ref.: **83431**
PVP: 12,95€

IP20

Max. w/m
50 W

AL
6063

Cut
to
Size

Escala / Scale / Échelle 1:1



Características técnicas / Technical data / Caractéristiques techniques

Potencia disipada / Power dissipation / Dissipation de puissance	Máx 50 W/M
Aleación de aluminio / Aluminium alloy / Puissance de Roulis	AL 6063
Longitud / Length / Longueur	2 M
IP	20

— Difusores PC / PC diffusers / Diffuseurs PC —



Referencia Reference Référence	Color Color Couleur	Medida Measure Étendue	PVP
83439	Opal / Opal / Opale	2m	7,25€

— Tapas / Caps / Tapas —



Referencia Reference Référence	Color Color Couleur	PVP
83436	Blanco / White / Blanc	0,50€

— Grapas / Staples / Agrafes —



Referencia Reference Référence	Color Color Couleur	PVP
83442	Aluminio / Aluminium / Aluminium	0,80€



Referencia Reference Référence	Color Color Couleur	PVP
83435	Blanco / White / Blanc	0,50€

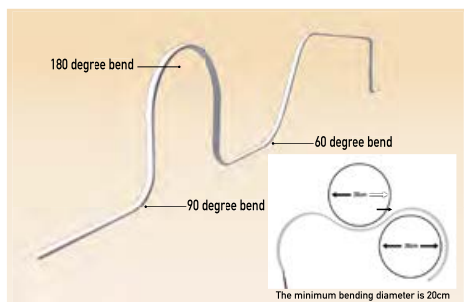

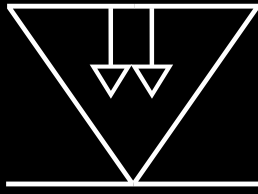

LYOPRO

LED PROFILE



Perfil Imantado
Magnetized profile
Profilé aimanté

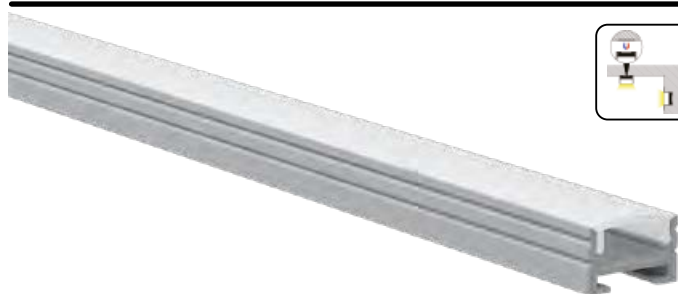

Perfil fabricado con aluminio extrusionado y anodizado. Diseñado como disipador de tiras de LED.

Profile made of extruded and anodized aluminium. Designed as a heatsink for LED strips.

Profil fabriqué en aluminium extrudé et anodisé. Conçu comme dissipateur thermique pour les bandes LED.



Plata 2m
Silver 2m
Argent 2m

Ref.: **83450**
PVP: 12,95€

IP20

Max. w/m
50 W

AL
6063

Cut
to
Size

Escala / Scale / Échelle 1:1

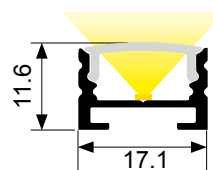
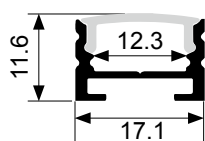

Características técnicas / Technical data / Caractéristiques techniques

Potencia disipada / Power dissipation / Dissipation de puissance	Máx 50 W/M
Aleación de aluminio / Aluminium alloy / Puissance de Roullis	AL 6063
Longitud / Length / Longueur	2 M
IP	20

— Difusores PC / PC diffusers / Diffuseurs PC —



Referencia Reference Référence	Color Color Couleur	Medida Measure Étendue	PVP
83459	Opal / Opal / Opale	2m	6,95€

— Magnético / Magnetic / Magnétique —



Referencia Reference Référence	PVP
83463	0,80€

— Tapas / Caps / Tapas —



Referencia Reference Référence	Color Color Couleur	PVP
83454	Plata / Silver / Argent	0,50€



Referencia Reference Référence	Color Color Couleur	PVP
83453	Plata / Silver / Argent	0,50€





Perfil perchero
Coat rack profile
Profilé de portemanteau



Perfil fabricado con aluminio extrusionado y anodizado. Diseñado como disipador de tiras de LED.

Profile made of extruded and anodized aluminium. Designed as a heatsink for LED strips.

Profil fabriqué en aluminium extrudé et anodisé. Conçu comme dissipateur thermique pour les bandes LED.

IP20

Max. w/m
50 W

AL
6063

Cut
to
Size

Plata 2m
Silver 2m
Argent 2m
Ref.: **83470**
PVP: 32,20€

Negro 2m
Black 2m
Noir 2m
Ref.: **83472**
PVP: 37,60€

Escala / Scale / Échelle 1:1

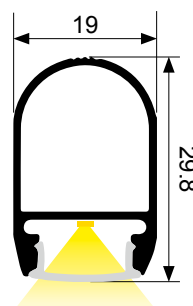
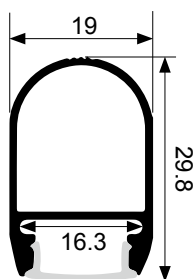

Características técnicas / Technical data / Caractéristiques techniques

Potencia disipada / Power dissipation / Dissipation de puissance	Máx 50 W/M
Aleación de aluminio / Aluminium alloy / Puissance de Roullis	AL 6063
Longitud / Length / Longueur	2 M
IP	20

— Difusores PC / PC diffusers / Diffuseurs PC —



Referencia Reference Référence	Color Color Couleur	Medida Measure Étendue	PVP
83479	Opal / Opal / Opale	2m	5,30€
83485	Negro / Black / Noir	2m	8,55€

— Apoyo / Support / Support —

Referencia Reference Référence	Tipo Guy Type	PVP
83482	Soporte de empotrar / Embedding support / Prise en charge de l'intégration	3,55€
83483	Soporte de superficie / Surface support / Montage en surface	2,95€
83484	Soporte colgante / Hanging bracket / Support de suspension	6,40€



83482



83483





83484





Luminarias circulares
Circular luminaires
Luminaire circulaires



			
630mm 3000K	630mm 4000K	970mm 3000K	970mm 4000K
Ref.: 87101 PVP: 779,95€	Ref.: 87102 PVP: 779,95€	Ref.: 87105 PVP: 1145,95€	Ref.: 87106 PVP: 1145,95€

IP40

Max. lm/w
105

PC

OPAL
diffuser

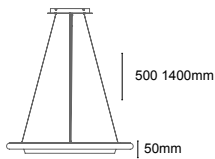

Ø 630mm

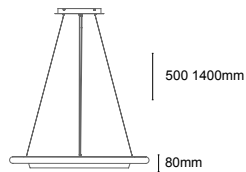

Ø 970mm

- Color del cuerpo: negro. / *Body colour: black.* / Couleur du corps : noir.
- Tipo de difusor: OPAL. / *Diuser type: OPAL.* / Type de diffuseur : OPALE.
- Caudal luminoso de hasta 105 lm/W. / *Luminous efficacy of up to 105 lm/W.* / Flux lumineux jusqu'à 105 lm/W.
- Rango de potencia de 21 a 37 W. / *Power range from 21 to 37 W.* / Plage de puissance de 21 à 37 W.
- El ux luminoso máximo es de 3800 lm. / *The maximum luminous ux is 3800 lm.* / Le ux lumineux maximum est de 3800 lm.
- Temperatura de color: 3000K, 4000K. / *Colour temperature: 3000K, 4000K.* / Température de couleur : 3000K, 4000K.
- Versiones múltiples con configuración ajustable de potencia y ux. / *Multi versions with adjustable power and ux settings.* / Plusieurs versions avec paramètres de puissance et ux réglables.
- Índice de reproducción cromática (Ra)>80. / *Colour rendering index (Ra)>80.* / Indice de rendu des couleurs (Ra)>80.





Blanco White Blanc 600mm 3000K	Blanco White Blanc 600mm 4000K	Blanco White Blanc 900mm 3000K	Blanco White Blanc 900mm 4000K	Blanco White Blanc 1200mm 3000K	Blanco White Blanc 1200mm 4000K
Ref.: 87121 PVP: 639,95€	Ref.: 87122 PVP: 639,95€	Ref.: 87125 PVP: 859,95€	Ref.: 87126 PVP: 859,95€	Ref.: 87129 PVP: 1395,95€	Ref.: 87130 PVP: 1395,95€
Negro Black Noir 600mm 3000K	Negro Black Noir 600mm 4000K	Negro Black Noir 900mm 3000K	Negro Black Noir 900mm 4000K	Negro Black Noir 1200mm 3000K	Negro Black Noir 1200mm 4000K
Ref.: 87133 PVP: 639,95€	Ref.: 87134 PVP: 639,95€	Ref.: 87137 PVP: 859,95€	Ref.: 87138 PVP: 859,95€	Ref.: 87141 PVP: 1395,95€	Ref.: 87142 PVP: 1395,95€

IP40

Max. lm/w
116

STEEL

OPAL
diffuser

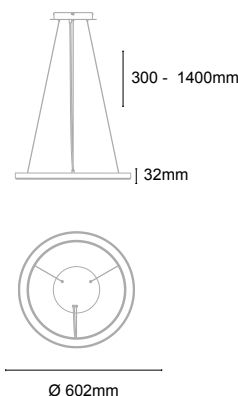
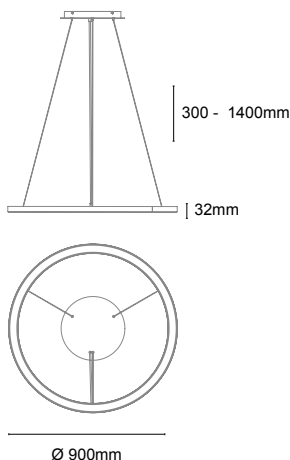
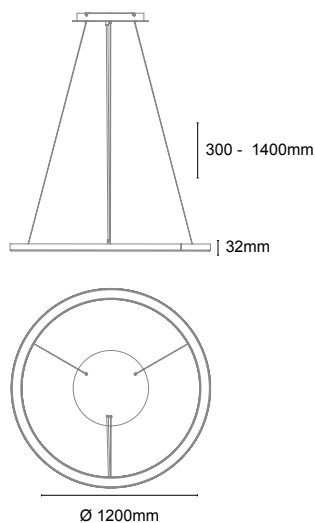

- Color del cuerpo: blanco, negro, cualquier color RAL.
Body colour: white, black, any RAL colour.
Couleur du corps : blanc, noir, toute couleur RAL.
- Tipo de difusor: OPAL.
Diuser type: OPAL.
Type de diffuseur : OPALE.
- Caudal luminoso de hasta 116 lm/W.
Luminous eacy of up to 116 lm/W.
Flux lumineux jusqu'à 116 lm/W.
- Rango de potencia de 30 a 53 W.
Power range from 30 to 53 W.
Plage de puissance de 30 à 53 W.
- El ux luminoso máximo es de 6100 lm.
The maximum luminous ux is 6100 lm.
Le ux lumineux maximum est de 6100 lm.
- Temperatura de color: 3000K, 4000K.
Colour temperature: 3000K, 4000K.
Température de couleur : 3000K, 4000K.
- Versiones múltiples con configuración ajustable de potencia y ux.
Multi versions with adjustable power and ux settings.
Plusieurs versions avec paramètres de puissance et ux réglables.
- Índice de reproducción cromática (Ra)>80.
Colour rendering index (Ra)>80.
Indice de rendu des couleurs (Ra)>80.





LYOPRO

LED PROFILE

Gran variedad de fuentes de alimentación, tanto IP20 como IP67, donde se presentan una amplia gama de potencias a 24V.

Wide variety of power sources, both IP20 and IP67, where they are presented a wide range of powers at 24V.

Grande variété de sources d'énergie, à la fois IP20 et IP67, où ils sont présentés une large gamme de puissances à 24V.

Fuentes de Alimentación
Power sources
Sources d'énergie



Referencia Reference Référence	W	Voltaje Entrada Input Voltage Tension d'entrée	Voltaje Entrada Output Voltage Tension de sortie	Corriente Salida Output current Courant de sortie	Eficiencia Efficacité Efficiency	Dimensiones Dimensions Dimensions	Material Material Matériel	PVP
85449	50W	90-264VAC	24V	2.1A	90%	99 x 82 x 30	Metal	25,95€
85500	75W	90-264VAC	24V	3.2A	90%	97 x 97 x 30	Metal	29,95€
85501	100W	90-264VAC	24V	4.5A	87%	129 x 97 x 30	Metal	33,95€
85502	150W	180-264VAC	24V	6.5A	88%	159 x 97 x 30	Metal	45,25€
85503	200W	180-264VAC	24V	8.8A	90%	215 x 115 x 30	Metal	58,65€
85504	350W	180-264VAC	24V	14.5A	88%	215 x 115 x 30	Metal	68,25€

IP67 Fuentes de Alimentación / Power sources / Sources d'énergie



Referencia Reference Référence	W	Voltaje Entrada Input Voltage Tension d'entrée	Voltaje Entrada Output Voltage Tension de sortie	Corriente Salida Output current Courant de sortie	Eficiencia Efficacité Efficiency	Dimensiones Dimensions Dimensions	Material Material Matériel	PVP
85510	20W	90-264VAC	24V	1.0A	85%	140 x 32 x 25	Plástico	19,95€
85511	60W	90-264VAC	24V	2.5A	84%	162 x 42 x 33	Plástico	32,75€
85512	75W	90-264VAC	24V	3.0A	86%	162 x 42 x 33	Metal	40,75€
85513	100W	90-264VAC	24V	4.2A	88%	190 x 52 x 37	Metal	54,25€
85514	150W	180-277VAC	24V	6.0A	89%	203 x 70 x 45	Metal	76,75€
85515	200W	200-264VAC	24V	8.3A	90%	203 x 70 x 45	Metal	112,25€
85516	350W	176-264VAC	24V	14.6A	98%	224 x 97 x 42	Metal	195,95€

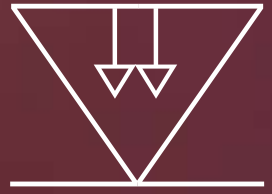

LYOPRO

LED PROFILE

Amplia gama de controladores en distintas aplicaciones, donde se presentan opciones de regulación monocolor, cambios de color RGB/RGBW, CCT y control de la tecnología LED lineal flexible ya sea a través de pulsadores, mandos a distancia, formato mecanismo, aplicación Android o IOS y siempre interconectados entre si de forma inalámbrica.

Wide range of controllers in different applications, where there are monochrome dimming options, RGB/RGBW color changes, CCT and control of flexible linear LED technology either through pushbuttons, remote controls, mechanism format, Android or IOS application and always interconnected with each other wirelessly.

Large gamme de contrôleurs dans différentes applications, où il existe des options de gradation monochrome, des changements de couleur RVB/RGBW, CCT et le contrôle de la technologie LED linéaire flexible via des boutons-poussoirs, des télécommandes, un format de mécanisme, une application Android ou IOS et toujours interconnectés les uns avec les autres sans fil .

Sistemas de control
Control systems
Systèmes de contrôle

CONECTE VARIOS SISTEMAS DE RF CONNECT MULTIPLE RF SYSTEMS CONNECTEZ PLUSIEURS SYSTÈMES RF

Nuestro WiFi-Relay (Wi-Fi Hub) le permite conectarse con una amplia variedad de sistemas de RF, incluidos controladores de LED, controladores de LED regulables, luces inteligentes, atenuadores de 0-10 V y Triac.

Our WiFi-Relay (Wi-Fi Hub) allows you to connect with a wide variety of RF systems, including LED drivers, dimmable LED drivers, smart lights, 0-10V dimmers, and Triac.

Notre WiFi-Relay (Wi-Fi Hub) vous permet de vous connecter à une grande variété de systèmes RF, y compris des pilotes LED, des pilotes LED dimmables, des lumières intelligentes, des gradateurs 0-10V et des Triac.



GRUPO INALÁMBRICO EN ZONAS MÚLTIPLES WIRELESS GROUP IN MULTIPLE ZONES GROUPE SANS FIL DANS PLUSIEURS ZONES

Múltiples luces LED con controlador LED pueden ser controladas por un control remoto al mismo tiempo. Presione un solo botón de zona para seleccionar una o varias luces en una habitación. Los controles remotos pueden tener 1-8 botones de zona dependiendo de la serie. Aún más, puede seleccionar hasta 16 zonas diferentes en la aplicación **LyoproAPP** en su teléfono a través del convertidor Wifi-Relay.

Multiple LED controller LED lights can be controlled by one remote at the same time. Press a single zone button to select one or multiple lights in a room. Remote controls can have 1-8 zone buttons depending on the series. Even more, you can select up to 16 different zones in the **LyoproAPP** on your phone via the Wifi-Relay converter.

Plusieurs lumières LED de contrôleur LED peuvent être contrôlées par une seule télécommande en même temps. Appuyez sur un seul bouton de zone pour sélectionner une ou plusieurs lumières dans une pièce. Les télécommandes peuvent avoir des boutons de 1 à 8 zones selon la série. De plus, vous pouvez sélectionner jusqu'à 16 zones différentes dans la **LyoproAPP** de votre téléphone via le convertisseur Wifi-Relay.

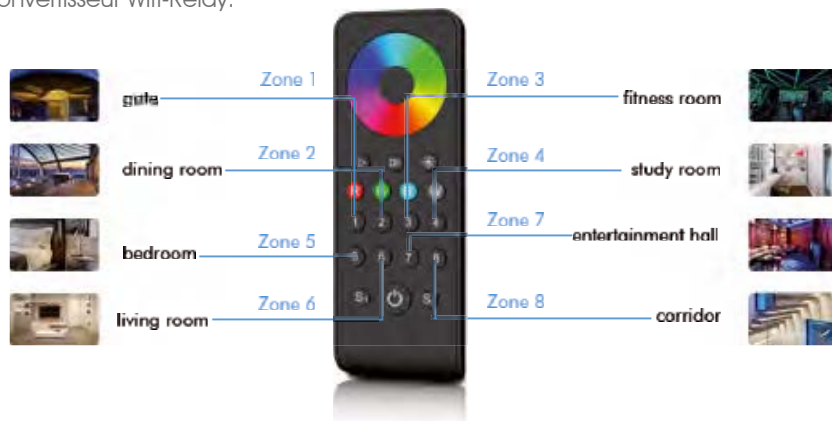

CONTROLADOR MONOCOLOR 3A SINGLE COLOR CONTROLLER 3A CONTRÔLEUR DE COULEUR UNIQUE 3A

Ref.: **88520**

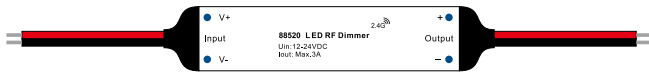

Control / Input Signal / Signal d'entrée	RF 2.4GHz
Voltaje de entrada / Input Voltage / Tension d'entrée	12-24VDC
Tensión de salida / Output Voltage / Tension de sortie	12-24VDC
Corriente de salida / Output Current / Courant de sortie	1Channel / 3A
Potencia de salida / Output Power / Puissance de sortie	75W
Tamaño / Size / Taille	L60 x W14 mm
Distancia / Distance / Distance	30M
Temperatura de trabajo / Working Temperature / Température de fonctionnement	-30°C~ +55°C
PVP	16,25€

- Controlador mini RF LED de un solo color de voltaje constante de 1 canal.
- 3A por canal, la salida se conecta con una tira de LED de un solo color de 5 metros, potencia máxima de salida 75W.
- Combina con el control remoto de atenuación de zona única o de zona múltiple 2.4G de LYOPRO.
- Un controlador de RF acepta hasta 10 controles remotos.
- 4096 niveles de 0-100% de atenuación suave sin flash.
- Función de transmisión automática: el controlador transmite automáticamente la señal a otro controlador con una distancia de control de 30m.
- Sincronizar en multiples números de controladores.

- *Constant Voltage Single Color Mini RF LED Driver 1 channel.*
- *3A per channel, the output is connected to a single LED strip 5 meter single color, maximum output power 75W.*
- *Combines with single zone dimming remote control or LYOPRO 2.4G multi-zone.*
- *An RF controller accepts up to 10 remote controls.*
- *4096 levels of 0-100% smooth dimming without flash.*
- *Automatic transmission function: the controller transmits automatically signal to another controller with a distance control of 30m.*
- *Synchronize on multiple numbers of controllers.*

- Pilote LED Mini RF unicolore à tension constante 1 canal.
- 3A par canal, la sortie est connectée à une seule bande LED 5 mètres de couleur unique, puissance de sortie maximale 75W.
- Se combine avec une télécommande de gradation à zone unique ou LYOPRO 2.4G multizone.
- Un contrôleur RF accepte jusqu'à 10 télécommandes.
- 4096 niveaux de gradation fluide de 0 à 100 % sans flash.
- Fonction de transmission automatique : le contrôleur transmet signaler automatiquement à un autre contrôleur avec une distance contrôle de 30m.
- Synchroniser sur plusieurs nombres de contrôleurs.

Instalación:

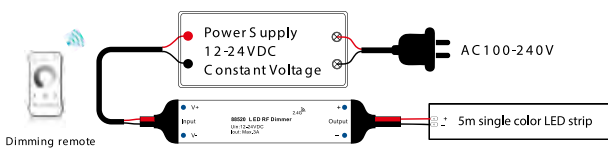

Como sincronizar el controlador

How to sync controller

Comment synchroniser le contrôleur



CONTROLADOR MONOCOLOR 8A SINGLE COLOR CONTROLLER 8A CONTRÔLEUR DE COULEUR UNIQUE 8A

Ref.: **88500**



Controlador monocolor / Single Colour Controller / Contrôleur de couleur unique

Control / Input Signal / Signal d'entrée	RF 2.4GHz + Push Dim
Voltaje de entrada / Input Voltage / Tension d'entrée	5-36VDC
Tensión de salida / Output Voltage / Tension de sortie	5-36VDC
Corriente de salida / Output Current / Courant de sortie	1Channel / 8A
Potencia de salida / Output Power / Puissance de sortie	192W
Tamaño / Size / Taille	L97 x W33 x H18 mm
Distancia / Distance / Distance	30M
Temperatura de trabajo / Working Temperature / Température de fonctionnement	-30°C~ +55°C
PVP	24,95€

- 4096 niveles 0-100% de atenuación suave sin ningún tipo de flash.
- Combina con el control remoto de atenuación de zona única 2.4GHz de LYOPRO o de zona múltiple.
- Un controlador RF acepta hasta 10 controles remotos.
- Función de transmisión automática: el controlador transmite automáticamente la señal a otro controlador con una distancia de control de 30 m.
- Sincronizar en múltiples controladores.
- Conecte con un pulsador externo para lograr la función de encendido / apagado y 0-100% de atenuación.

- *4096 levels 0-100% smooth dimming without any of flash.*
- *Combines with single zone dimming remote control LYOPRO 2.4GHz or multi-zone.*
- *An RF controller accepts up to 10 remote controls.*
- *Automatic transmission function: the controller transmits automatically signal to another controller with a distance control of 30 m.*
- *Synchronize on multiple controllers.*
- *Connect with an external push button to achieve the function of on/off and 0-100% dimming.*

- 4096 niveaux 0-100% gradation en douceur sans aucun d'éclair.
- Se combine avec une télécommande de gradation à zone unique LYOPRO 2.4GHz ou multizone.
- Un contrôleur RF accepte jusqu'à 10 télécommandes.
- Fonction de transmission automatique : le contrôleur transmet signaler automatiquement à un autre contrôleur avec une distance contrôle de 30 m.
- Synchroniser sur plusieurs contrôleurs.
- Connectez-vous avec un bouton poussoir externe pour réaliser la fonction de marche/arrêt et gradation 0-100 %.

Instalación:

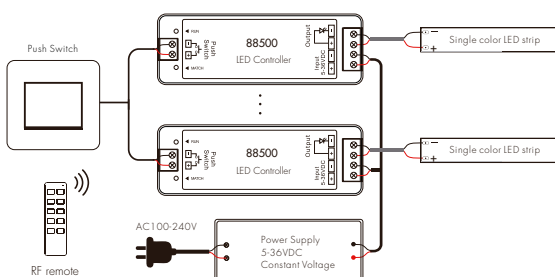

Como sincronizar el controlador

How to sync controller

Comment synchroniser le contrôleur



CONTROLADOR MONOCOLOR 15A SINGLE COLOR CONTROLLER 15A CONTRÔLEUR DE COULEUR UNIQUE 15A

Ref.: **88501**



- Controlador mini RF LED de un solo color de voltaje constante de 1 canal.
- 3A por canal, la salida se conecta con una tira de LED de un solo color de 5 metros, potencia máxima de salida 75W.
- Combina con el control remoto de atenuación de zona única o de zona múltiple 2.4G de LYOPRO.
- Un controlador de RF acepta hasta 10 controles remotos.
- 4096 niveles de 0-100% de atenuación suave sin flash.
- Función de transmisión automática: el controlador transmite automáticamente la señal a otro controlador con una distancia de control de 30m.
- Sincronizar en múltiples números de controladores.

- *Constant Voltage Single Color Mini RF LED Driver 1 channel.*
- *3A per channel, the output is connected to a single LED strip 5 meter single color, maximum output power 75W.*
- *Combines with single zone dimming remote control or LYOPRO 2.4G multi-zone.*
- *An RF controller accepts up to 10 remote controls.*
- *4096 levels of 0-100% smooth dimming without flash.*
- *Automatic transmission function: the controller transmits automatically signal to another controller with a distance control of 30m.*
- *Synchronize on multiple numbers of controllers.*

- Pilote LED Mini RF unicolore à tension constante 1 canal.
- 3A par canal, la sortie est connectée à une seule bande LED 5 mètres de couleur unique, puissance de sortie maximale 75W.
- Se combine avec une télécommande de gradation à zone unique ou LYOPRO 2.4G multizone.
- Un contrôleur RF accepte jusqu'à 10 télécommandes.
- 4096 niveaux de gradation fluide de 0 à 100 % sans flash.
- Fonction de transmission automatique : le contrôleur transmet signaler automatiquement à un autre contrôleur avec une distance contrôle de 30m.
- Synchroniser sur plusieurs numéros de contrôleurs.

Control / Input Signal / Signal d'entrée	RF 2.4GHz + Push Dim
Voltaje de entrada / Input Voltage / Tension d'entrée	12-24VDC
Tensión de salida / Output Voltage / Tension de sortie	12-24VDC
Corriente de salida / Output Current / Courant de sortie	1Channel / 15A
Potencia de salida / Output Power / Puissance de sortie	360W
Tamaño / Size / Taille	L175 x W45 x H27 mm
Distancia / Distance / Distance	30M
Temperatura de trabajo / Working Temperature / Température de fonctionnement	-30°C~+55°C
PVP	39,95€

Instalación:

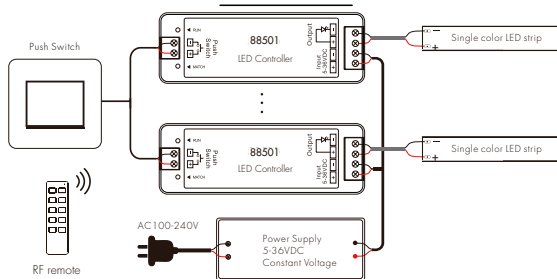

Como sincronizar el controlador

How to sync controller

Comment synchroniser le contrôleur



CONTROLADOR RGB 3X1A RGB CONTROLLER X1A CONTRÔLEUR RVB 3X1A

Ref.: **88522**



- Mini controlador RF LED RGB de voltaje constante de 3 canales.
- 1A por canal, conexión de salida con tira de LED RGB de 5 metros, potencia de salida máxima 75W.
- Combina con el control remoto RF 2.4G de zona única o de múltiples zonas RGB / RGBW.
- Un controlador de RF acepta hasta 10 controles remotos.
- 4096 niveles 0-100% de atenuación suave sin flash.
- Construido en 10 modos dinámicos, incluye salto o estilo de cambio gradual.
- Función de transmisión automática: el controlador transmite automáticamente la señal a otro controlador con una distancia de control de 30 m.
- Sincronizar en varios controladores.

- *Mini 3-Channel Constant Voltage RGB LED RF Controller.*
- *1A per channel, output connection with RGB LED strip of 5 meters, maximum output power 75W.*
- *Combines with single zone or single zone 2.4G RF remote multiple RGB/RGBW zones.*
- *An RF controller accepts up to 10 remote controls.*
- *4096 levels 0-100% smooth dimming without flash.*
- *Built in 10 dynamic modes, includes jump or style of gradual change.*
- *Automatic transmission function: the controller transmits automatically signal to another controller with a distance control of 30 m.*
- *Synchronize on multiple controllers.*

- Mini contrôleur RF LED RVB à tension constante à 3 canaux.
- 1A par canal, connexion de sortie avec bande LED RGB de 5 mètres, puissance de sortie maximale 75W.
- Se combine avec une télécommande RF 2.4G à zone unique ou à zone unique plusieurs zones RVB/RVBW.
- Un contrôleur RF accepte jusqu'à 10 télécommandes.
- 4096 niveaux 0-100% gradation douce sans flash.
- Construit en 10 modes dynamiques, comprend le saut ou le style de changement graduel.
- Fonction de transmission automatique : le contrôleur transmet signaler automatiquement à un autre contrôleur avec une distance contrôle de 30 m.
- Synchroniser sur plusieurs contrôleurs.

Control / Input Signal / Signal d'entrée	RF 2.4GHz
Voltaje de entrada / Input Voltage / Tension d'entrée	12-24VDC
Tensión de salida / Output Voltage / Tension de sortie	12-24VDC
Corriente de salida / Output Current / Courant de sortie	3 Channel / 1A
Potencia de salida / Output Power / Puissance de sortie	3x24W
Tamaño / Size / Taille	L60 x W14 mm
Distancia / Distance / Distance	30M
Temperatura de trabajo / Working Temperature / Température de fonctionnement	-30°C~+55°C
PVP	16,95€

Instalación:

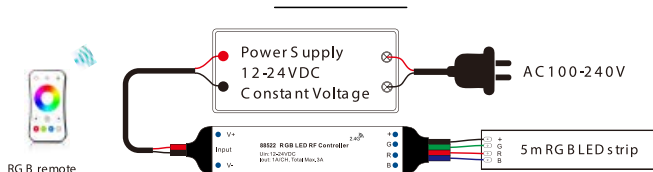

Como sincronizar el controlador

How to sync controller

Comment synchroniser le contrôleur



CONTROLADOR RGB/RGBW 4X1A GB/RGBW CONTROLLER 4X1A CONTRÔLEUR RVB/RVBW 4X1A

Ref.: **88523**

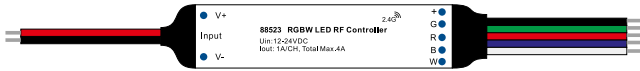

Control / Input Signal / Signal d'entrée	RF 2.4GHz
Voltaje de entrada / Input Voltage / Tension d'entrée	12-24VDC
Tensión de salida / Output Voltage / Tension de sortie	12-24VDC
Corriente de salida / Output Current / Courant de sortie	4 Channel / 1A
Potencia de salida / Output Power / Puissance de sortie	4x24W
Tamaño / Size / Taille	L60 x W14 mm
Distancia / Distance / Distance	30M
Temperatura de trabajo / Working Temperature / Température de fonctionnement	-30°C~ +55°C
PVP	17,95€

- Mini controlador RF LED RGB de voltaje constante de 4 canales.
- 1A por canal, conexión de salida con tira de LED RGBW de 5 metros, potencia de salida máxima 75W.
- Combine con el control remoto RGB / RGBW de zona única o zona múltiple 2.4G de LYOPRO.
- Un controlador de RF acepta hasta 10 controles remotos.
- 4096 niveles 0-100% de atenuación suave sin flash.
- Construido en 10 modos dinámicos, incluye salto o estilo de cambio gradual.
- Función de transmisión automática: el controlador transmite automáticamente la señal a otro controlador con una distancia de control de 30 m.
- Sincronizar en múltiples números de controladores.

- Mini 4 channel constant voltage RGB LED RF controller.
- 1A per channel, output connection with RGBW LED strip of 5 meters, maximum output power 75W.
- Combine with single-zone RGB/RGBW remote control or LYOPRO multiple zone 2.4G.
- An RF controller accepts up to 10 remote controls.
- 4096 levels 0-100% smooth dimming without flash.
- Built in 10 dynamic modes, includes jump or style of gradual change.
- Automatic transmission function: the controller transmits automatically signal to another controller with a distance control of 30 m.
- Synchronize on multiple numbers of controllers.

- Mini contrôleur RF LED RVB à tension constante à 4 canaux.
- 1A par canal, connexion de sortie avec bande LED RGBW de 5 mètres, puissance de sortie maximale 75W.
- À combiner avec une télécommande RGB/RGBW à zone unique ou LYOPRO multizone 2.4G.
- Un contrôleur RF accepte jusqu'à 10 télécommandes.
- 4096 niveaux 0-100% gradation douce sans flash.
- Construit en 10 modes dynamiques, comprend le saut ou le style de changement graduel.
- Fonction de transmission automatique : le contrôleur transmet signaler automatiquement à un autre contrôleur avec une distance contrôle de 30 m.
- Synchroniser sur plusieurs numéros de contrôleurs.

Instalación:

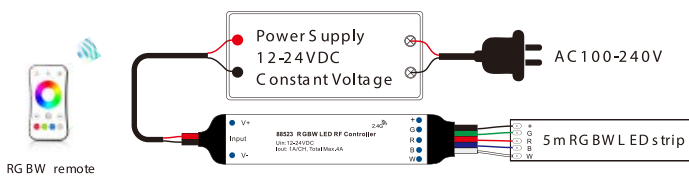

Como sincronizar el controlador

How to sync controller

Comment synchroniser le contrôleur



CONTROLADOR RGB/RGBW 4X5A RGB/RGBW CONTROLLER 4X5A CONTRÔLEUR RVB/RVBW 4X5A

Ref.: **88502**



Controlador RGB/RGBW / RGB/RGBW Controller / Contrôleurs RGB/RGBW

Control / Input Signal / Signal d'entrée	RF 2.4GHz + Push Dim
Voltaje de entrada / Input Voltage / Tension d'entrée	12-36VDC
Tensión de salida / Output Voltage / Tension de sortie	4x(12-36)VDC
Corriente de salida / Output Current / Courant de sortie	4 Channel / 5A / CH
Potencia de salida / Output Power / Puissance de sortie	4x120W
Tamaño / Size / Taille	L175 x W45 x H27 mm
Distancia / Distance / Distance	30M
Temperatura de trabajo / Working Temperature / Température de fonctionnement	-30°C~ +55°C
PVP	45,95€

- Combina con el control remoto de color único, color dual y RGB / RGBW de LYOPRO.
- Un controlador RF acepta hasta 10 controles remotos.
- Cuando se usa con luz RGB / RGBW, integrado en el modo dinámico 10, incluye estilo de salto o cambio gradual.
- Función de transmisión automática: el controlador transmite automáticamente la señal a otro controlador con una distancia de control de 30 m.
- Sincronizar en múltiples controladores.
- Conecte con un pulsador externo para lograr la función de encendido / apagado y regulación.

- Match with single color, dual color and remote control LYOPRO RGB/RGBW.
- An RF controller accepts up to 10 remote controls.
- When used with RGB / RGBW light, integrated in the mode dynamic 10, includes jumping style or gradual change.
- Automatic transmission function: the controller transmits automatically signal to another controller with a distance control of 30 m.
- Synchronize on multiple controllers.
- Connect with an external push button to achieve the function of on/off and dimming.

- Assorti avec une seule couleur, une double couleur et une télécommande LYOPRO RVB/RVBW.
- Un contrôleur RF accepte jusqu'à 10 télécommandes.
- Lorsqu'il est utilisé avec la lumière RGB / RGBW, intégré dans le mode dynamique 10, comprend un style de saut ou un changement progressif.
- Fonction de transmission automatique : le contrôleur transmet signaler automatiquement à un autre contrôleur avec une distance contrôle de 30 m.
- Synchroniser sur plusieurs contrôleurs.
- Connectez-vous avec un bouton poussoir externe pour réaliser la fonction de marche/arrêt et gradation.

Instalación:

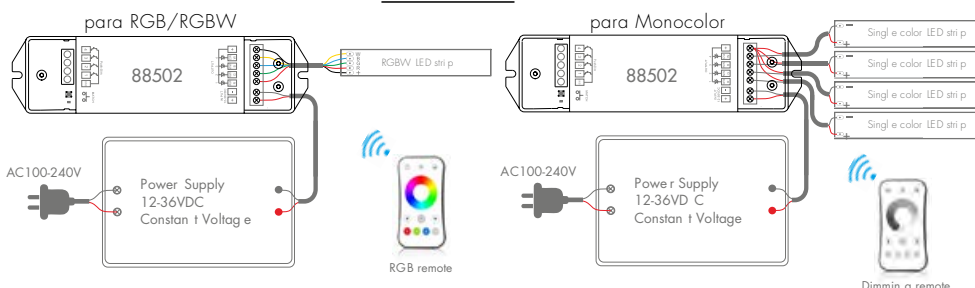

Como sincronizar el controlador

How to sync controller

Comment synchroniser le contrôleur



CONTROLADOR CCT 2x1,5A

CCT CONTROLLER 2x1,5A

CONTRÔLEUR CCT 2x1,5A

Ref.: **88521**

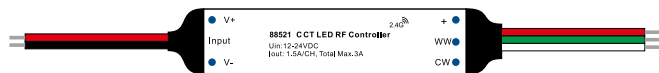

- Mini controlador RF LED de doble color y voltaje constante de 2 canales.
- 1.5A por canal, la salida se conecta con una tira de LED de doble color de 5 metros, potencia de salida máxima 75W.
- Combine con el control remoto de doble color de una o dos zonas 2.4G de LYOPRO.
- Un controlador de RF acepta hasta 10 controles remotos.
- 4096 niveles 0-100% de atenuación suave sin flash.
- Construido en 10 modos dinámicos, incluye salto o estilo de cambio gradual.
- Función de transmisión automática: el controlador transmite automáticamente la señal a otro controlador con una distancia de control de 30 m.
- Sincronizar en múltiples números de controladores.

- *Mini Constant Voltage Dual Color RF LED Driver 2 channels.*
- *1.5A per channel, the output is connected to a LED strip of 5 meter double color, maximum output power 75W.*
- *Combine with one or two color double remote control LYOPRO 2.4G zones.*
- *An RF controller accepts up to 10 remote controls.*
- *4096 levels 0-100% smooth dimming without flash.*
- *Built in 10 dynamic modes, includes jump or style of gradual change.*
- *Automatic transmission function: the controller transmits automatically signal to another controller with a distance control of 30 m.*
- *Synchronize on multiple numbers of controllers.*

- Pilote LED RF double couleur à tension constante 2 canaux.
- 1,5A par canal, la sortie est connectée à une bande LED de 5 mètres double couleur, puissance de sortie maximale 75W.
- À combiner avec une ou deux télécommandes double couleur Zones LYOPRO 2.4G.
- Un contrôleur RF accepte jusqu'à 10 télécommandes.
- 4096 niveaux 0-100% gradation douce sans flash.
- Construit en 10 modes dynamiques, comprend le saut ou le style de changement graduel.
- Fonction de transmission automatique : le contrôleur transmet signaler automatiquement à un autre contrôleur avec une distance contrôle de 30 m.
- Synchroniser sur plusieurs numéros de contrôleurs

Control / Input Signal / Signal d'entrée	RF 2.4GHz
Voltaje de entrada / Input Voltage / Tension d'entrée	12-24VDC
Tensión de salida / Output Voltage / Tension de sortie	12-24VDC
Corriente de salida / Output Current / Courant de sortie	2 Channel / 1.5A
Potencia de salida / Output Power / Puissance de sortie	2x36W
Tamaño / Size / Taille	L60 x W14 mm
Distancia / Distance / Distance	30M
Temperatura de trabajo / Working Temperature / Température de fonctionnement	-30°C~+55°C
PVP	17,95€

Instalación:

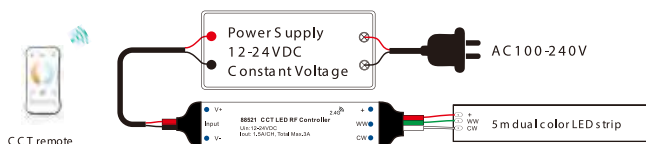

Como sincronizar el controlador

How to sync controller

Comment synchroniser le contrôleur



CONTROLADOR RGB+CCT 5x5A

RGB+CCT CONTROLLER 5x5A

CONTRÔLEUR RVB+CCT 5x5A

Ref.: **88514**



- Combina con el control remoto 2.4G RGB + CCT de LYOPRO.
- Un controlador RF acepta hasta 10 controles remotos.
- Construido en 10 modos dinámicos, incluye estilo de salto o cambio gradual.
- Función de transmisión automática: el controlador transmite automáticamente la señal a otro controlador con una distancia de control de 30 m.
- Sincronizar en múltiples controladores.
- Conecte con un pulsador externo para lograr la función de encendido / apagado y regulación.

- *Match with LYOPRO's 2.4G RGB+CCT remote control.*
- *An RF controller accepts up to 10 remote controls.*
- *Built in 10 dynamic modes, includes jump style or gradual change.*
- *Automatic transmission function: the controller transmits automatically signal to another controller with a distance control of 30 m.*
- *Synchronize on multiple controllers.*
- *Connect with an external push button to achieve the function of on/off and dimming.*

- Compatible avec la télécommande 2.4G RGB+CCT de LYOPRO.
- Un contrôleur RF accepte jusqu'à 10 télécommandes.
- Construit en 10 modes dynamiques, comprend le style de saut ou changement graduel.
- Fonction de transmission automatique : le contrôleur transmet signaler automatiquement à un autre contrôleur avec une distance contrôle de 30 m.
- Synchroniser sur plusieurs contrôleurs.
- Connectez-vous avec un bouton poussoir externe pour réaliser la fonction de marche/arrêt et gradation.

Controlador RGB+CCT / RGB+CCT Controller / Contrôleur RGB+CCT

Control / Input Signal / Signal d'entrée	RF 2.4GHz + Push Dim
Voltaje de entrada / Input Voltage / Tension d'entrée	12-34VDC
Tensión de salida / Output Voltage / Tension de sortie	5x(12-24)VDC
Corriente de salida / Output Current / Courant de sortie	5 Channel / 5A
Potencia de salida / Output Power / Puissance de sortie	5x120W
Tamaño / Size / Taille	L175 x W45 x H27 mm
Distancia / Distance / Distance	30M
Temperatura de trabajo / Working Temperature / Température de fonctionnement	-30°C~+55°C
PVP	61,95€

Instalación:

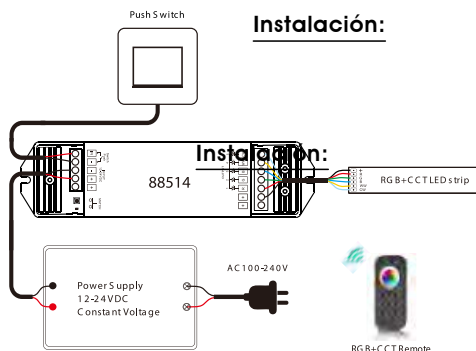

Como sincronizar el controlador

How to sync controller

Comment synchroniser le contrôleur



REGULADOR INALAMBRICO AC TRIAC WIRELESS AC TRIAC REGULATOR RÉGULATEUR TRIAC AC SANS FIL

Ref.: **88503**



- Regulador de corte de fase RF + Push AC, salida de 1 canal.
- Para atenuar y cambiar las lámparas LED de un solo color, Luces incandescentes y halógenas tradicionales.
- Atenuación de borde anterior o atenuación de borde posterior configurada mediante un interruptor DIP.
- El brillo mínimo se puede configurar por tecla.
- Compatibilidad con el control remoto de atenuación 2.4GHz de LYOPRO.
- Conecte con un pulsador externo para lograr la función de encendido / apagado y regulación.
- Fácil de insertar en una caja de pared estándar de 86 * 86 mm.

para lámparas Led 230V dimmable por Triac para drivers dimmable por Triac

- RF + Push AC phase cut dimmer, 1 channel output.
- To dim and change single color LED lamps, Traditional incandescent and halogen lights.
- Leading Edge Dimming or Trailing Edge Dimming configured via a DIP switch.
- Minimum brightness can be set per key.
- 2.4GHz dimming remote control support of LYOPRO.
- Connect with an external push button to achieve the function of on/off and dimming.
- Easy to insert into a standard 86*86mm wall box.

- Variateur à coupure de phase RF + Push AC, sortie 1 canal.
- Pour faire varier et changer les lampes LED monochromes, Lampes à incandescence et halogènes traditionnelles.
- Gradation du bord d'attaque ou gradation du bord de fuite configuré via un commutateur DIP.
- La luminosité minimale peut être définie par touche.
- Prise en charge de la télécommande à gradation 2,4 GHz de LYOPRO.
- Connectez-vous avec un bouton poussoir externe pour réaliser la fonction de marche/arrêt et gradation.
- Facile à insérer dans une boîte murale standard de 86*86mm.

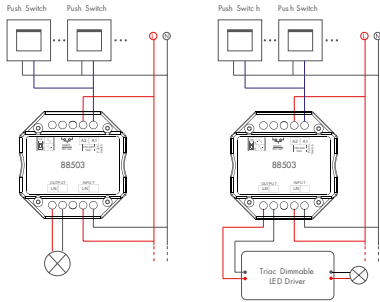

Instalación:

Como sincronizar el controlador

How to sync controller

Comment synchroniser le contrôleur



INTERRUPTOR INALAMBRICO ON/OFF WIRELESS ON/OFF SWITCH INTERRUPTEUR MARCHÉ/ARRÊT SANS FIL

Ref.: **88504**



- Interruptor inteligente RF con salida de relé, sin función de regulación.
- Para controlar lámparas y tiras led con salida 230VAC.
- Compatibilidad con el control remoto de atenuación 2.4GHz de LYOPRO.
- Conectar con pulsador externo opcional.
- Fácil de insertar en una caja de pared estándar de 86 * 86 mm.

- RF smart switch with relay output, without function of regulation.
- To control lamps and led strips with 230VAC output.
- 2.4GHz dimming remote control support of LYOPRO.
- Connect with optional external button.
- Easy to insert into a standard 86*86mm wall box.

- Interrupteur intelligent RF avec sortie relais, sans fonction de régulation.
- Pour contrôler les lampes et les bandes led avec sortie 230VAC.
- Prise en charge de la télécommande à gradation 2,4 GHz de LYOPRO.
- Connectez-vous avec le bouton externe en option.
- Facile à insérer dans une boîte murale standard de 86*86mm.

Instalación:

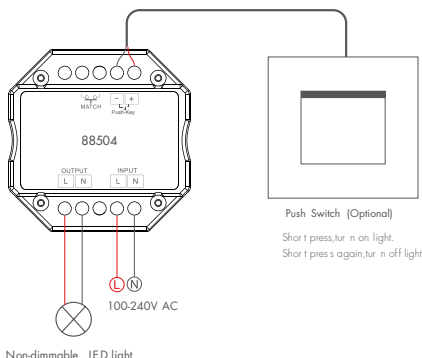

Como sincronizar el controlador

How to sync controller

Comment synchroniser le contrôleur



INTERRUPTOR INALAMBRICO ON/OFF 3A WIRELESS ON/OFF SWITCH 3A INTERRUPTEUR MARCHE/ARRÊT SANS FIL 3A

Ref.: **88505**



- Regulador de corte de fase RF + Push AC, salida de 1 canal.
- Para atenuar y cambiar las lámparas LED de un solo color, Luces incandescentes y halógenas tradicionales.
- Atenuación de borde anterior o atenuación de borde posterior configurada mediante un interruptor DIP.
- El brillo mínimo se puede configurar por tecla.
- Compatibilidad con el control remoto de atenuación 2.4GHz de LYOPRO.
- Conecte con un pulsador externo para lograr la función de encendido / apagado y regulación.
- Fácil de insertar en una caja de pared estándar de 86 * 86 mm.

- RF + Push AC phase cut dimmer, 1 channel output.
- To dim and change single color LED lamps, Traditional incandescent and halogen lights.
- Leading Edge Dimming or Trailing Edge Dimming configured via a DIP switch.
- Minimum brightness can be set per key.
- 2.4GHz dimming remote control support of LYOPRO.
- Connect with an external push button to achieve the function of on/off and dimming.
- Easy to insert into a standard 86*86mm wall box.

- Variateur à coupure de phase RF + Push AC, sortie 1 canal.
- Pour faire varier et changer les lampes LED monochromes, Lampes à incandescence et halogènes traditionnelles.
- Gradation du bord d'attaque ou gradation du bord de fuite configuré via un commutateur DIP.
- La luminosité minimale peut être définie par touche.
- Prise en charge de la télécommande à gradation 2,4 GHz de LYOPRO.
- Connectez-vous avec un bouton poussoir externe pour réaliser la fonction de marche/arrêt et gradation.
- Facile à insérer dans une boîte murale standard de 86*86mm.

Interruptor inalámbrico ON/OFF / ON/OFF wireless switch / Interrupteur sans fil ON/OFF

Control / Input Signal / Signal d'entrée	RF 2.4GHz + Push switch
Voltaje de entrada / Input Voltage / Tension d'entrée	AC 100-240VAC
Tensión de salida / Output Voltage / Tension de sortie	AC 100-240VAC
Corriente de salida / Output Current / Courant de sortie	Max 3A
Potencia de salida / Output Power / Puissance de sortie	720W
Tamaño / Size / Taille	L52 x W52 x H26 mm
Distancia / Distance / Distance	30M
Temperatura de trabajo / Working Temperature / Température de fonctionnement	-30°C~+55°C
PVP	57,95€

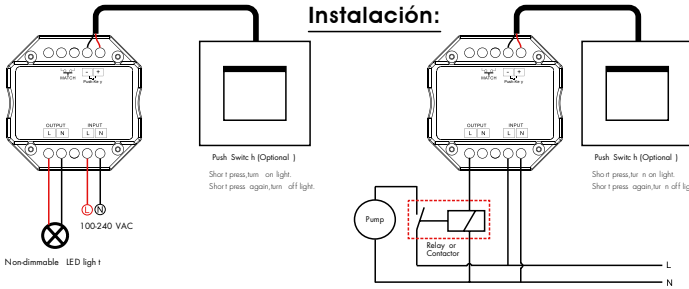

Como sincronizar el controlador
How to sync controller
Comment synchroniser le contrôleur



REPETIDOR SEÑAL SIGNAL REPEATER RÉPÉTEUR DE SIGNAL

Ref.: **88550**

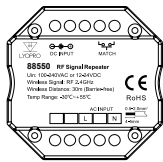

- Solicite la extensión de la señal inalámbrica, asegura en gran medida la estabilidad de la comunicación RF y un área de control amplia.
- Alimentado por AC100-240V o DC12-24V.
- Compatibilidad con control remoto RF 2.4G.
- Fácil de colocar en una caja de conexiones de pared estándar.

- Apply for wireless signal extension, greatly ensures measure the stability of RF communication and an area of wide control.
- Powered by AC100-240V or DC12-24V.
- Support 2.4G RF remote control.
- Easy to fit into a standard wall junction box.

- Appliquer pour l'extension du signal sans fil, assure grandement mesurer la stabilité de la communication RF et une zone de large contrôle.
- Alimenté par AC100-240V ou DC12-24V.
- Prise en charge de la télécommande RF 2.4G.
- Facile à installer dans une boîte de jonction murale standard.

Control / Input Signal / Signal d'entrée	RF 2.4GHz + Push Switch
Voltaje de entrada / Input Voltage / Tension d'entrée	AC 100-240VAC
Tensión de salida / Output Voltage / Tension de sortie	AC 100-240VAC
Corriente de salida / Output Current / Courant de sortie	Max 1.5A
Potencia de salida / Output Power / Puissance de sortie	360W
Tamaño / Size / Taille	L52 x W52 x H26 mm
Distancia / Distance / Distance	30M
Temperatura de trabajo / Working Temperature / Température de fonctionnement	-30°C~+55°C
PVP	57,95€

Instalación:

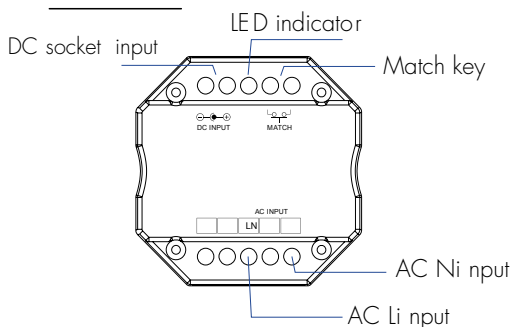

CONTROLADOR MONOCOLOR Y RGB ON/OFF MONO-COLOR AND RGB ON/OFF CONTROLLER CONTRÔLEUR MARCHÉ/ARRÊT MONOCOLORE ET RGB

Ref.: **88506**



Controlador monocolor RGB ON/OFF / Monocolor RGB ON/OFF controller / Contrôleur ON/OFF RGB monochrome

Control / Input Signal / Signal d'entrée	RF 2.4GHz + Push Switch
Voltaje de entrada / Input Voltage / Tension d'entrée	110-240VAC
Tensión de salida / Output Voltage / Tension de sortie	3x(110-240)VAC
Corriente de salida / Output Current / Courant de sortie	3 CH 1A/CH
Potencia de salida / Output Power / Puissance de sortie	3x240W
Tamaño / Size / Taille	L175 x W45 x H27 mm
Distancia / Distance / Distance	30M
Temperatura de trabajo / Working Temperature / Température de fonctionnement	-30°C~+55°C
PVP	87,95€

- Controlador de tira LED de alto voltaje de 3 canales RF 2.4GHz, puede controlar un máximo de 50 metros de tira de LED de alto voltaje 230VAC.
- Combine con el control remoto de 2.4G de un solo color, doble color y RGB / RGBW de LYOPRO.
- Un controlador RF acepta hasta 10 controles remotos.
- Cuando se usa con luz RGB, incorporada en modo dinámico 10, incluye estilo de salto o cambio gradual.
- Función de transmisión automática: el controlador transmite automáticamente la señal a otro controlador con una distancia de control de 30 m.
- Sincronizar en múltiples controladores.

- 3 Channel RF 2.4GHz High Voltage LED Strip Controller, can control a maximum of 50 meters high LED strip voltage 230VAC.
- Combine with single color, double 2.4G remote control LYOPRO color and RGB/RGBW.
- An RF controller accepts up to 10 remote controls.
- When used with RGB light, built-in dynamic mode 10, includes jumping style or gradual change.
- Automatic transmission function: the controller transmits automatically signal to another controller with a distance control of 30 m.
- Synchronize on multiple controllers.

- Contrôleur de bande LED haute tension RF 2,4 GHz à 3 canaux, peut contrôler un maximum de 50 mètres de bande LED de haut tension 230VAC.
- Combiner avec une seule couleur, double télécommande 2.4G Couleur LYOPRO et RVB/RVBW.
- Un contrôleur RF accepte jusqu'à 10 télécommandes.
- Lorsqu'il est utilisé avec la lumière RVB, mode dynamique intégré 10, comprend un style de saut ou un changement progressif.
- Fonction de transmission automatique : le contrôleur transmet signaler automatiquement à un autre contrôleur avec une distance contrôle de 30 m.
- Synchroniser sur plusieurs contrôleurs.

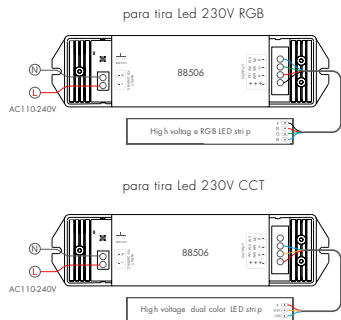

Instalación:

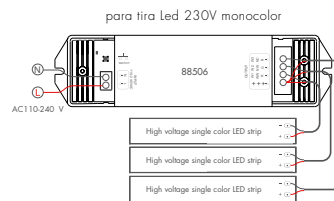

Como sincronizar el controlador
How to sync controller
Comment synchroniser le contrôleur



TUYA MONOCOLOR Y CCT 2X5A TUYA MONOCOLOR AND CCT 2X5A TUYA MONOCOLORE ET CCT 2X5A

Ref.: **88551**



- Se utiliza para controlar una tira de LED de un solo color o temperatura de color.
- Entrada de toma de corriente CC y salida de voltaje constante de 2 canales.
- Control de nube de la aplicación Tuya, soporte encendido / apagado, temperatura de color y ajuste de brillo, retardo de encendido/apagado de la luz, función de ejecución del temporizador, escena y reproducción de música.
- Control de voz, compatible con el altavoz inteligente Amazon ECHO y TmallGenie.
- Combina con el control remoto RF 2.4G opcional.
- El usuario debe configurar el tipo de luz presionando la tecla antes de la conexión de red de la APLICACIÓN Tuya y hacer coincidir el control remoto RF del mismo tipo de luz.
- Cada controlador WT1 también puede funcionar como convertidor WiFi-RF, luego use la APLICACIÓN Tuya para controlar uno o más controladores LED RF o controlador de atenuación RF LED sincrónicamente.
- Conecte con un interruptor de empuje externo para lograr la función de atenuación de encendido / apagado y 0-100%.

- Used to control a single color LED strip or color temperature.
- DC power socket input and constant voltage output 2 channels.
- Tuya APP cloud control, support on/power off, color temperature and brightness adjustment, sleep delay light on/off, run function timer, scene and music playback.
- Voice control, compatible with Amazon smart speaker ECHO and TmallGenie.
- Match with optional 2.4G RF remote controller.
- The user must set the type of light by pressing the key before Tuya APP network connection and do match the RF remote control of the same type of light.
- Each WT1 controller can also work as a converter WiFi-RF, then use Tuya APP to control one or more RF LED drivers or RF LED dimming driver synchronously.
- Connect with external push switch to achieve on/off and 0-100% dimming function.

- Utilisé pour contrôler une bande de LED à une seule couleur ou température de couleur.
- Entrée de prise d'alimentation CC et sortie à tension constante 2 canaux.
- Contrôle du cloud Tuya APP, prise en charge sur/mise hors tension, réglage de la température de couleur et de la luminosité, délai de veille lumière marche/arrêt, fonction run minuterie, scène et lecture de musique.
- Commande vocale, compatible avec le haut-parleur intelligent Amazon ECHO et TmallGenie.
- Match avec la télécommande RF 2.4G en option.
- L'utilisateur doit régler le type de lumière en appuyant sur la touche avant la connexion réseau Tuya APP et faire correspondre à la télécommande RF du même type de lumière.
- Chaque contrôleur WT1 peut également fonctionner comme un convertisseur WiFi-RF, puis utilisez l'application Tuya pour contrôler un ou plus de pilotes de LED RF ou pilote de gradation de LED RF de manière synchrone.
- Connectez-vous avec un interrupteur à poussoir externe pour obtenir une fonction marche/arrêt et une fonction de gradation de 0 à 100 %.

Instalación:

For single color r



Dimming remote Press and hold match/set key for 1s, until the RUN LED indicator turn white, then release, the controller will become DMX type, then do smart config by tuya APP, or short press match key to match with dimming RF remote.

For dual color CCT

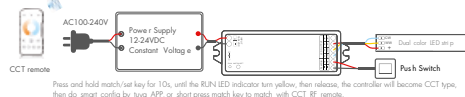

CCT remote Press and hold match/set key for 1.5s, until the RUN LED indicator turn yellow, then release, the controller will become CCT type, then do smart config by tuya APP, or short press match key to match with CCT RF remote.

Note: User can connect constant voltage power supply or power adapter as power input.

TUYA MONOCOLOR Y RGB+CCT 5X5A TUYA MONOCOLOR AND RGB+CCT 5X5A TUYA MONOCOULEUR ET RGB+CCT 5X5A

Ref.: **88552**



- Función 5 en 1, utilizada para controlar RGB, RGBW, RGB + CCT, temperatura de color o tira de LED de un solo color.
- Entrada de toma de corriente CC y salida de voltaje constante de 5 canales.
- Control de nube de la aplicación Tuya, soporte encendido/apagado, color RGB, temperatura de color y ajuste de brillo, retardo de encendido/apagado de la luz, función de ejecución del temporizador, escena y reproducción de música.
- Control de voz, compatible con el altavoz inteligente Amazon ECHO y TmallGenie.
- Combina con el control remoto RF 2.4G opcional.
- El usuario debe configurar el tipo de luz presionando la tecla antes de la conexión de red de la APLICACIÓN Tuya y hacer coincidir el control remoto RF del mismo tipo de luz.
- Cada controlador WT5 también puede funcionar como convertidor WiFi-RF, luego use la APLICACIÓN Tuya para controlar uno o más controladores LED RF o controlador de atenuación LED RF sincrónico

- 5 in 1 function, used to control RGB, RGBW, RGB+CCT, color temperature or single color LED strip.
- DC power outlet input and constant voltage output of 5 channels.
- Tuya APP cloud control, support power on/off, RGB color, color temperature and brightness adjustment, delay of light on/off, run function timer, scene and music playback.
- Voice control, compatible with Amazon smart speaker ECHO and TmallGenie.
- Match with optional 2.4G RF remote controller.
- The user must set the type of light by pressing the key before Tuya APP network connection and do match the RF remote control of the same type of light.
- Each WT5 controller can also work as a converter WiFi-RF, then use Tuya APP to control one or more RF LED drivers or synchronous RF LED dimming driver

- Fonction 5 en 1, utilisée pour contrôler RGB, RGBW, RGB+CCT, température de couleur ou bande LED monochrome.
- Entrée de prise de courant CC et sortie de tension constante de 5 canaux.
- Contrôle du cloud Tuya APP, prise en charge marche/arrêt, Couleur RVB, réglage de la température de couleur et de la luminosité, délai de lumière marche/arrêt, fonction run minuterie, scène et lecture de musique.
- Commande vocale, compatible avec le haut-parleur intelligent Amazon ECHO et TmallGenie.
- Match avec la télécommande RF 2.4G en option.
- L'utilisateur doit régler le type de lumière en appuyant sur la touche avant la connexion réseau Tuya APP et faire correspondre à la télécommande RF du même type de lumière.
- Chaque contrôleur WT5 peut également fonctionner comme un convertisseur WiFi-RF, puis utilisez l'application Tuya pour contrôler un ou plusieurs Pilotes de LED RF ou pilote de gradation de LED RF synchrone

Instalación:

For RGB+CCT



RGB+CCT remote Press and hold match/set key for 1.6s, until the RUN LED indicator turn blue, then release, the controller will become RGB+CCT type, then do smart config by tuya APP, or short press match key to match with RGB+CCT RF remote.

For RGBW

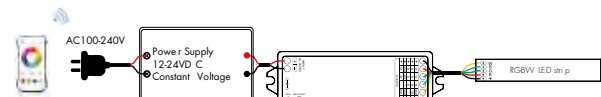

RGBW remote Press and hold match/set key for 1.4s, until the RUN LED indicator turn green, then release, the controller will become RGBW type, then do smart config by tuya APP, or short press match key to match with RGBW RF remote.

TUYA REGULADOR AC TRIAC 1,5A TUYA AC REGULATOR TRIAC 1.5A TUYA AC REGULATEUR TRIAC 1.5A

Ref.: **88556**



- Atenuador de corte de fase WiFi + RF + Push AC, salida de 1 canal.
- Para atenuar y cambiar lámparas LED regulables de un solo color, luces tradicionales incandescentes y halógenas.
- Control de nube de la aplicación Tuya, soporte encendido/apagado, ajuste de brillo, retardo de encendido / apagado de la luz, funcionamiento del temporizador, función de escena.
- Control de voz, compatible con el altavoz inteligente Amazon ECHO y TmallGenie.
- 256 niveles 0-100% de atenuación suave sin flash.
- Regulación del borde de ataque o del borde de fuga configurada por el interruptor DIP.
- El brillo mínimo se puede configurar con la tecla.
- Compatibilidad con control remoto de atenuación de zona única o zona múltiple RF 2.4G.
- Cada controlador 88556 también puede funcionar como convertidor WiFi-RF, luego use la APLICACIÓN Tuya para controlar uno o más controladores LED de atenuación de RF o controladores sincrónicamente.
- Conecte con un interruptor de empuje externo para lograr la función de atenuación de encendido/apagado y 0-100%.
- Fácil de colocar en una caja de conexiones de pared estándar detrás de un interruptor.
- Protección contra sobrecalentamiento / sobrecarga, se recupera automáticamente.

Instalación:

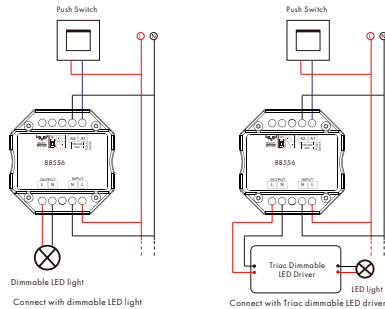

Tuya regulador AC TRIAC 1,5A / Tuya AC regulator TRIAC 1.5A / Tuya AC régulateur TRIAC 1.5A

Control / Input Signal / Signal d'entrée	Tuya APP+RF +Push Dim
Voltaje de entrada / Input Voltage / Tension d'entrée	AC100-240V
Tensión de salida / Output Voltage / Tension de sortie	AC100-240V
Corriente de salida / Output Current / Courant de sortie	Max 1,5A
Potencia de salida / Output Power / Puissance de sortie	360W
Tamaño / Size / Taille	L52 x W52 x H26 mm
Distancia / Distance / Distance	30M
Temperatura de trabajo / Working Temperature / Température de fonctionnement	-30°C~+55°C
PVP	93,95€

- WiFi + RF + Push AC Phase Cut Dimmer, 1 channel output.
- For dimming and changing single color dimmable LED lamps, traditional incandescent and halogen lighting.
- Tuya APP cloud control, support power on/off, brightness adjustment, power on delay/light off, timer operation, scene function.
- Voice control, compatible with Amazon ECHO and TmallGenie smart speaker.
- 256 levels 0-100% smooth dimming without flash.
- Regulation of the leading edge or the trailing edge configured by the DIP switch.
- The minimum brightness can be set with the key.
- Support 2.4G RF single zone or multi zone dimming remote control.
- Each 88556 controller can also work as WiFi-RF converter, then use Tuya APP to control one or more RF dimming LED drivers or drivers synchronously.
- Connect with an external push switch to achieve on/off and 0-100% dimming function.
- Easy to fit into a standard wall junction box behind a switch.
- Overheat / overload protection, recovers automatically.

- Variateur à coupure de phase WiFi + RF + Push AC, sortie 1 canal.
- Pour la gradation et le changement des lampes LED à gradation monochrome, éclairage traditionnel à incandescence et halogène.
- Contrôle du cloud Tuya APP, prise en charge marche/arrêt, réglage de la luminosité, délai de mise sous tension / lumière éteinte, fonctionnement de la minuterie, fonction scène.
- Commande vocale, compatible avec le haut-parleur intelligent Amazon ECHO et TmallGenie.
- 256 niveaux de gradation fluide de 0 à 100 % sans flash.
- Régulation du front montant ou du front descendant configuré par le DIP switch.
- La luminosité minimale peut être réglée avec la touche.
- Prise en charge de la télécommande de gradation à zone unique ou multizone RF 2.4G.
- Chaque contrôleur 88556 peut également fonctionner comme convertisseur WiFi-RF, puis utiliser l'application Tuya pour contrôler un ou plusieurs pilotes ou pilotes de LED à gradation RF de manière synchrone.
- Connectez-vous avec un interrupteur à poussoir externe pour obtenir une fonction marche/arrêt et une fonction de gradation de 0 à 100 %.
- Facile à installer dans une boîte de jonction murale standard derrière un interrupteur.
- Protection contre la surchauffe / surcharge, récupère automatiquement.

TUYA INTERRUPTOR ON/OFF 1,5A TUYA ON/OFF SWITCH 1.5A INTERRUPTEUR MARCHÉ/ARRÊT TUYA 1.5A

Ref.: **88555**



- Interruptor inteligente de empuje WiFi + RF + AC, sin función de atenuación.
- Para cambiar entre lámparas LED de un solo color, tradicionales incandescentes y halógenas.
- Tuya APP control de nube, soporte encendido / apagado, retardo de encendido / apagado de luz y función de ejecución del temporizador.
- Control de voz, compatible con el altavoz inteligente Amazon ECHO y TmallGenie.
- Compatibilidad con control remoto de atenuación RF 2.4G.
- Cada controlador SS-B (WT) también puede funcionar como convertidor WiFi-RF, luego use la APLICACIÓN Tuya para controlar uno o más interruptores o controladores de RF sincrónicamente.
- Conectar con interruptor de empuje externo opcional.
- Fácil de colocar en una caja de conexiones de pared estándar detrás de un interruptor.
- Protección contra sobrecalentamiento / sobrecarga, se recupera automáticamente.

- WiFi + RF + AC smart push switch, without dimming function.
- To switch between single color, traditional LED lamps incandescent and halogen.
- Tuya APP cloud control, support power on/off, delay light on/off and timer run function.
- Voice control, compatible with Amazon ECHO and TmallGenie smart speaker.
- Support 2.4G RF dimming remote control.
- Each SS-B (WT) controller can also work as a WiFi-RF converter, then use the Tuya APP to control one or more switches or RF controllers synchronously.
- Connect with optional external push switch.
- Easy to fit into a standard wall junction box behind a switch.
- Overheat / overload protection, recovers automatically.

- Interrupteur poussoir intelligent WiFi + RF + AC, sans fonction de gradation.
- Pour basculer entre les lampes LED traditionnelles monochromes incandescent et halogène.
- Contrôle du cloud Tuya APP, prise en charge marche/arrêt, retard marche/arrêt de la lumière et fonction de minuterie.
- Commande vocale, compatible avec le haut-parleur intelligent Amazon ECHO et TmallGenie.
- Prise en charge de la télécommande de gradation RF 2.4G.
- Chaque contrôleur SS-B (WT) peut également fonctionner comme un convertisseur WiFi-RF, puis utilisez l'application Tuya pour contrôler un ou plusieurs commutateurs ou contrôleurs RF de manière synchrone.
- Connectez-vous avec un interrupteur poussoir externe en option.
- Facile à installer dans une boîte de jonction murale standard derrière un interrupteur.
- Protection contre la surchauffe / surcharge, récupère automatiquement.

Instalación:

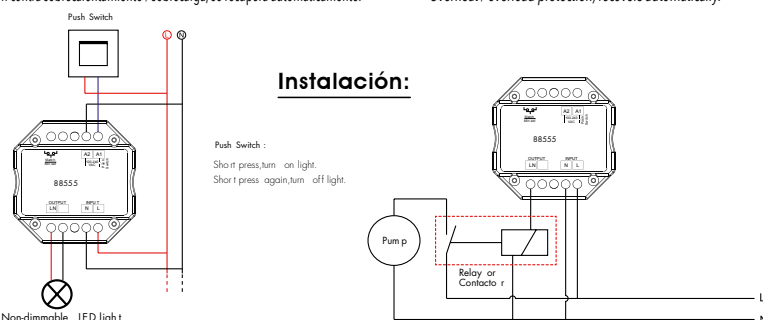

Tuya interruptor on/off 1,5A / Tuya on/off switch 1.5A / Interrupteur marche/arrêt Tuya 1.5A

Control / Input Signal / Signal d'entrée	Tuya APP+RF+Push switch
Voltaje de entrada / Input Voltage / Tension d'entrée	AC100-240V
Tensión de salida / Output Voltage / Tension de sortie	AC100-240V
Corriente de salida / Output Current / Courant de sortie	Max 1,5A
Potencia de salida / Output Power / Puissance de sortie	360W
Tamaño / Size / Taille	L52 x W52 x H26 mm
Distancia / Distance / Distance	30M
Temperatura de trabajo / Working Temperature / Température de fonctionnement	-30°C~+55°C
PVP	87,95€

REGULADOR DALI 15A 24V

DALI DIMMER 15A 24V

VARIATEUR DALI 15A 24V

Ref.: **88564**



- Dimmer LED DALI de tensión constante de 1 canal, salida 15A.
- De acuerdo con el protocolo estándar DALI IEC 62386-102, IEC 62386-207 y de acuerdo con los productos DALI de otra incorporación internacional.
- La dirección DALI será asignada automáticamente por el maestro DALI, 1 dirección DALI.
- Atenuación digital PWM, curva de atenuación logarítmica DALI estándar.
- Conecte con un interruptor de empuje externo para lograr la función de encendido / apagado y atenuación.
- Protección contra sobrecalentamiento / sobrecarga / cortocircuito, se recupera automáticamente

- 1-channel constant voltage DALI LED dimmer, 15A output.
- In accordance with the DALI standard protocol IEC 62386-102, IEC 62386-207 and in accordance with the DALI products of another international incorporation.
- The DALI address will be automatically assigned by the DALI master, 1 DALI address.
- PWM digital dimming, standard DALI logarithmic dimming curve.
- Connect with external push switch to achieve on/off and dimming function.
- Overheat/overload/short circuit protection, recovers automatically

Instalación:

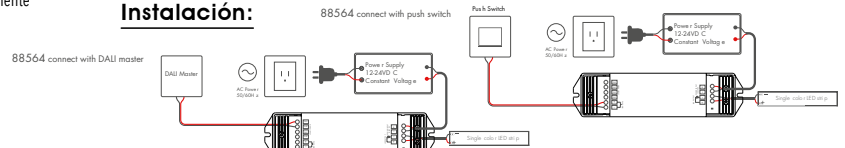

Regulador DALI 15A 24V / Dimmer DALI 15A 24V / Variateur DALI 15A 24V

Control / Input Signal / Signal d'entrée	DALI+ Push Dim
Voltaje de entrada / Input Voltage / Tension d'entrée	12-24VDC
Tensión de salida / Output Voltage / Tension de sortie	12-24VDC
Corriente de salida / Output Current / Courant de sortie	1CH, 15A
Potencia de salida / Output Power / Puissance de sortie	360W
Tamaño / Size / Taille	L175 x W45 x H27 mm
Distancia / Distance / Distance	30M
Temperatura de trabajo / Working Temperature / Température de fonctionnement	-30°C~+55°C
PVP	79,95€

- Variateur LED DALI 1 canal à tension constante, sortie 15A.
- Conformément au protocole standard DALI IEC 62386-102, IEC 62386-207 et conformément aux produits DALI d'une autre incorporation internationale.
- L'adresse DALI sera automatiquement attribuée par le maître DALI, 1 adresse DALI.
- Gradation numérique PWM, courbe de gradation logarithmique standard DALI.
- Connectez-vous avec un interrupteur à poussoir externe pour obtenir la fonction marche/arrêt et la gradation.
- Protection contre la surchauffe/surcharge/court-circuit, récupère automatiquement.

REGULADOR DALI 4X5A 24V

DALI DIMMER 4X5A 24V

VARIATEUR DALI 4X5A 24V

Ref.: **88565**



- Dimmer LED DALI de tensión constante de 4 canales, 5A por canal.
- 4 direcciones DALI, 4 canales funcionan por separado.
- De acuerdo con el protocolo estándar DALI IEC 62386-102, IEC 62386-207 y de acuerdo con los productos DALI de otra incorporación internacional.
- La dirección DALI será asignada automáticamente por el maestro DALI.
- Atenuación digital PWM, curva de atenuación logarítmica DALI estándar.
- Protección contra sobrecargas / cortocircuitos, se recupera automáticamente.

- 4-channel constant voltage DALI LED dimmer, 5A per channel.
- 4 DALI addresses, 4 channels work separately.
- In accordance with the DALI standard protocol IEC 62386-102, IEC 62386-207 and in accordance with the DALI products of another international incorporation.
- The DALI address will be assigned automatically by the DALI master.
- PWM digital dimming, standard DALI logarithmic dimming curve.
- Overload/short circuit protection, recovers automatically.

Regulador DALI 4X5A 24V / Dimmer DALI 4X5A 24V / Variateur DALI 4X5A 24V

Control / Input Signal / Signal d'entrée	DALI
Voltaje de entrada / Input Voltage / Tension d'entrée	12-24VDC
Tensión de salida / Output Voltage / Tension de sortie	12-24VDC
Corriente de salida / Output Current / Courant de sortie	4CH, 5A/CH
Potencia de salida / Output Power / Puissance de sortie	4x120W
Tamaño / Size / Taille	L175 x W45 x H27 mm
Distancia / Distance / Distance	30M
Temperatura de trabajo / Working Temperature / Température de fonctionnement	-30°C~+55°C
PVP	97,95€

- Gradateur LED DALI à tension constante à 4 canaux, 5A par canal.
- 4 adresses DALI, 4 canaux fonctionnent séparément.
- Conformément au protocole standard DALI IEC 62386-102, IEC 62386-207 et conformément aux produits DALI d'une autre incorporation internationale.
- L'adresse DALI sera attribuée automatiquement par le maître DALI.
- Gradation numérique PWM, courbe de gradation logarithmique standard DALI.
- Protection contre les surcharges/courts-circuits, récupère automatiquement.

Instalación:

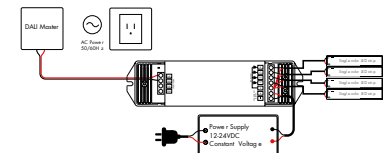

CONTROLADOR DALI A AC TRIAC 1,5A

DALI CONTROLLER TO AC TRIAC 1.5A

CONTRÔLEUR DALI VERS AC TRIAC 1.5A

Ref.: **88563**

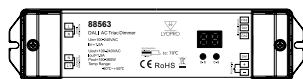

- Regulador DALI mosfet de corte de fase CA, una dirección DALI, una salida de canal.
- De acuerdo con el protocolo estándar DALI IEC 62386-102, IEC 62386-207 y de acuerdo con los productos DALI de otra incorporación internacional.
- La dirección DALI puede asignarse manualmente y mostrarse en la pantalla digital o asignarse automáticamente por el maestro DALI.
- Atenuación de fase inversa o atenuación de fase directa seleccionable.
- Conecte con un interruptor de empuje externo para lograr la función de atenuación de encendido / apagado y 0-100%.
- Para atenuar y cambiar lámparas LED regulables de un solo color, luces tradicionales incandescentes y halógenas.
- Protección contra sobrecalentamiento, se recupera automáticamente.

- DALI AC phase cut mosfet dimmer, one DALI address, one channel output.
- In accordance with the DALI standard protocol IEC 62386-102, IEC 62386-207 and in accordance with the DALI products of another international incorporation.
- The DALI address can be manually assigned and displayed on the digital display or automatically assigned by the DALI master.
- Reverse phase dimming or forward phase dimming selectable.
- Connect with external push switch to achieve on/off and 0-100% dimming function.
- For dimming and changing single color dimmable LED lamps, traditional incandescent and halogen lighting.
- Overheat protection, recovers automatically.

Controlador DALI A AC TRIAC 1,5A / DALI controller A AC TRIAC 1.5A / Contrôleur DALI A AC TRIAC 1.5A

Control / Input Signal / Signal d'entrée	DALI
Voltaje de entrada / Input Voltage / Tension d'entrée	AC 100-240V
Tensión de salida / Output Voltage / Tension de sortie	AC 100-240V
Corriente de salida / Output Current / Courant de sortie	1CH, 15A
Potencia de salida / Output Power / Puissance de sortie	360W
Tamaño / Size / Taille	L187 x W46 x H22 mm
Distancia / Distance / Distance	30M
Temperatura de trabajo / Working Temperature / Température de fonctionnement	-30°C~+55°C
PVP	98,95€

- Gradateur mosfet à coupure de phase DALI AC, une adresse DALI, une sortie de canal.
- Conformément au protocole standard DALI IEC 62386-102, IEC 62386-207 et conformément aux produits DALI d'une autre incorporation internationale.
- L'adresse DALI peut être attribuée manuellement et affichée sur l'affichage numérique ou attribuée automatiquement par le maître DALI.
- Gradation en phase inverse ou gradation en phase directe sélectionnable.
- Connectez-vous avec un interrupteur à poussoir externe pour obtenir une fonction marche/arrêt et une fonction de gradation de 0 à 100%.
- Pour la gradation et le changement des lampes LED à gradation monochrome, éclairage traditionnel à incandescence et halogène.
- Protection contre la surchauffe, récupère automatiquement.

Instalación:

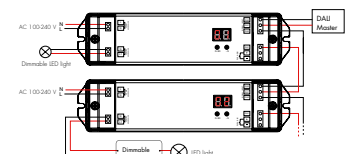

REGULADOR 0/1-10V PARA 1 LUMINARIA REGULATOR FOR 1 LUMINAIRE 0/1-10V REGULATEUR 0/1-10V POUR 1 LUMINAIRE

Ref.: **88560**

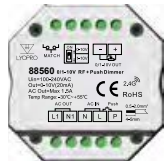

- Regulador pulsador de 0 / 1-10V RF o AC, salida de 1 canal.
- Salida de 1 canal de señal 0 / 1-10V, conectar con controlador regulable 0 / 1-10V.
- Entrada de CA de alto voltaje, salida de relé de CA de alto voltaje.
- Salida de 0-10 V o 1-10 V seleccionable mediante interruptor DIP.
- 256 niveles 0-100% de atenuación suave sin flash.
- Compatibilidad con control remoto de atenuación de zona única o zona múltiple RF 2.4G.
- Conecte con un interruptor de empuje externo para lograr la función de atenuación de encendido / apagado 0-100%.
- Fácil de colocar en una caja de conexiones de pared estándar detrás de un interruptor.

- 0 / 1-10V RF or AC push-button dimmer, 1-channel output.
- 1 channel 0/1-10V signal output, connect with 0/1-10V dimmable controller.
- AC high voltage input, AC high voltage relay output.
- 0-10 V or 1-10 V output selectable by DIP switch.
- 256 levels 0-100% smooth dimming without flash.
- Support 2.4G RF single zone or multi zone dimming remote control.
- Connect with external push switch to achieve on/off and 0-100% dimming function.
- Easy to fit into a standard wall junction box behind a switch.

Regulador 0/1-10V 1 luminaria / Dimmer 0/1-10V 1 luminaire / Variateur 0/1-10V 1 luminaire

Control / Input Signal / Signal d'entrée	RF 2.4GHz+Push Dim
Voltaje de entrada / Input Voltage / Tension d'entrée	AC100-240V
Corriente de salida / Output Current / Courant de sortie	Max 1,5A
Salida de señal Output signal	0/1-10V (20mA)
Tamaño / Size / Taille	L52 x W52 x H26 mm
Distancia / Distance / Distance	30M
Temperatura de trabajo / Working Temperature / Température de fonctionnement	-30°C~+55°C
PVP	68,95€

- Variateur à bouton-poussoir 0 / 1-10V RF ou AC, sortie 1 voie.
- Sortie de signal 1 canal 0/1-10V, connexion avec contrôleur dimmable 0/1-10V.
- Entrée haute tension CA, sortie relais haute tension CA.
- Sortie 0-10 V ou 1-10 V sélectionnable par commutateur DIP.
- 256 niveaux de gradation fluide de 0 à 100 % sans flash.
- Prise en charge de la télécommande de gradation à zone unique ou multizone RF 2.4G.
- Connectez-vous avec un interrupteur à poussoir externe pour obtenir une fonction marche/arrêt et une fonction de gradation de 0 à 100 %.
- Facile à installer dans une boîte de jonction murale standard derrière un interrupteur.

Instalación:

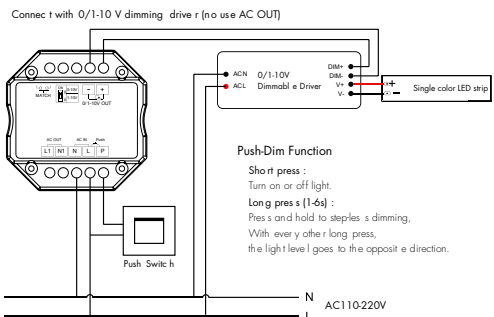

REGULADOR 0/1-10V PARA 4 LUMINARIAS REGULATOR FOR 4 LUMINAIRE 0/1-10V REGULATEUR 0/1-10V POUR 4 LUMINAIRE

Ref.: **88561**



Instalación:

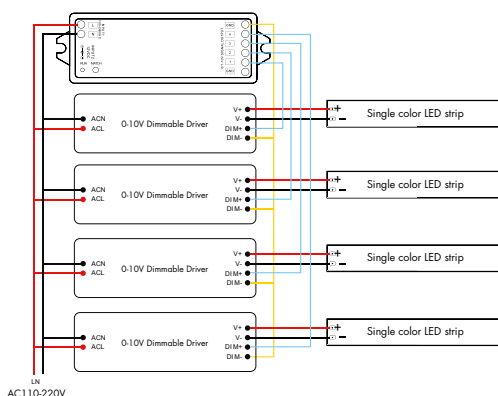

Regulador 0/1-10V 4 luminarias / Dimmer 0/1-10V 4 lights / Variateur 0/1-10V 4 lumières

Control / Input Signal / Signal d'entrée	RF 2.4GHz
Voltaje de entrada / Input Voltage / Tension d'entrée	100-240VAC - 12VDC
Corriente de salida / Output Current / Courant de sortie	4CH, 10mA/CH
Salida de señal Output signal	4x(0-10)VDC
Tamaño / Size / Taille	L114 x W38 x H20 mm
Distancia / Distance / Distance	30M
Temperatura de trabajo / Working Temperature / Température de fonctionnement	-30°C~+55°C
PVP	79,95€

- Convertidor de RF a 4 canales 0-10V, alimentado por entrada AC o DC.
- Salida de señal de 4 canales 0-10V, conectar con controlador regulable 0 / 1-10V.
- 256 niveles 0-100% de atenuación suave sin flash.
- Combina con el control remoto RF 2.4G de un solo color, de dos colores y RGB / RGBW.
- Un controlador de RF acepta hasta 10 controles remotos.
- Función de transmisión automática: el controlador transmite automáticamente la señal a otro controlador con una distancia de control de 30 m.
- Sincronizar en varios controladores.

- RF converter to 4 channels 0-10V, powered by AC or DC input.
- 4 channel 0-10V signal output, connect with 0/1-10V dimmable controller.
- 256 levels 0-100% smooth dimming without flash.
- Match with single color, two color and RGB/RGBW 2.4G RF remote control.
- An RF controller accepts up to 10 remote controls.
- Automatic transmission function: the controller automatically transmits the signal to another controller with a control distance of 30m.
- Synchronize on multiple controllers.

- Convertisseur RF vers 4 canaux 0-10V, alimenté par entrée AC ou DC.
- Sortie de signal 0-10V à 4 canaux, connectez-vous avec un contrôleur dimmable 0/1-10V.
- 256 niveaux de gradation fluide de 0 à 100 % sans flash.
- Associez-le à une télécommande RF unicolore, bicolore et RGB/RGBW 2.4G.
- Un contrôleur RF accepte jusqu'à 10 télécommandes.
- Fonction de transmission automatique: le contrôleur transmet automatiquement le signal à un autre contrôleur avec une distance de contrôle de 30 m.
- Synchroniser sur plusieurs contrôleurs.

REGULADOR 0/1-10V PARA 4 LUMINARIAS (REPETIDOR)

0/1-10V DIMMER FOR 4 LUMINAIRES (REPEATER)

VARIATEUR 0/1-10V POUR 4 LUMINAIRES (REPETITEUR)

Ref.: **88562**



- Convertidor de RF a 4 canales 0-10V, alimentado por entrada AC o DC.
- Salida de señal de 4 canales 0-10V, conectar con controlador regulable 0 / 1-10V.
- Entrada de CA de alto voltaje, salida de relé de CA de alto voltaje.
- Salida de 0-10 V o 1-10 V seleccionable mediante interruptor DIP.
- 256 niveles 0-100% de atenuación suave sin flash.
- Combina con el control remoto RF 2.4G de un solo color, de dos colores y RGB / RGBW.
- Un controlador de RF acepta hasta 10 controles remotos.
- Función de transmisión automática: el controlador transmite automáticamente la señal a otro controlador con una distancia de control de 30 m.
- Sincronizar en varios controladores.

Instalación:

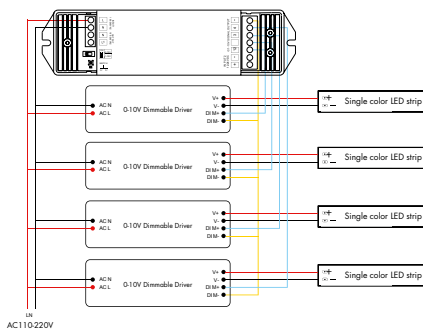

Regulador 0/1-10V 4 luminarias / Dimmer 0/1-10V 4 lights / Variateur 0/1-10V 4 lumières

Control / Input Signal / Signal d'entrée	RF 2.4GHz
Voltaje de entrada / Input Voltage / Tension d'entrée	100-240VAC - 12VDC
Corriente de salida / Output Current / Courant de sortie	0/1-10V: 20mA/CH Max 3A
Salida de señal Output signal	4x(0-10)VDC
Tamaño / Size / Taille	L175 x W45 x H27 mm
Distancia / Distance / Distance	30M
Temperatura de trabajo / Working Temperature / Température de fonctionnement	-30°C~+55°C
PVP	109,95€

- RF converter to 4 channels 0-10V, powered by AC or DC input.
- 4 channel 0-10V signal output, connect with 0/1-10V dimmable controller.
- AC high voltage input, AC high voltage relay output.
- 0-10 V or 1-10 V output selectable by DIP switch.
- 256 levels 0-100% smooth dimming without flash.
- Match with single color, two color and RGB/RGBW 2.4G RF remote control.
- An RF controller accepts up to 10 remote controls.
- Automatic transmission function: the controller automatically transmits the signal to another controller with a control distance of 30m.
- Synchronize on multiple controllers.

- Convertisseur RF vers 4 canaux 0-10V, alimenté par entrée AC ou DC.
- Sortie de signal 0-10V à 4 canaux, connectez-vous avec un contrôleur dimmable 0/1-10V.
- Entrée haute tension CA, sortie relais haute tension CA.
- Sortie 0-10 V ou 1-10 V sélectionnable par commutateur DIP.
- 256 niveaux de gradation fluide de 0 à 100 % sans flash.
- Associez-le à une télécommande RF unicolore, bicolore et RGB/RGBW 2.4G.
- Un contrôleur RF accepte jusqu'à 10 télécommandes.
- Fonction de transmission automatique : le contrôleur transmet automatiquement le signal à un autre contrôleur avec une distance de contrôle de 30 m.
- Synchroniser sur plusieurs contrôleurs.

REGULADOR 0/1-10V A AC TRIAC 2A

REGULATOR 0/1-10V TO AC TRIAC 2A

REGULATEUR 0/1-10V A AC TRIAC 2A

Ref.: **88568**



- RF + 0 / 1-10V Atenuador de corte de fase AC Push, salida de 1 canal.
- Para atenuar y cambiar lámparas LED regulables de un solo color, luces tradicionales incandescentes y halógenas.
- Compatibilidad con control remoto de atenuación de zona única o zona múltiple RF 2.4G.
- Compatible con atenuador activo o pasivo 0-10V, 1-10V.
- Conecte con un interruptor de empuje externo para lograr la función de atenuación de encendido / apagado y 0-100%.
- 256 niveles 0-100% de atenuación suave sin flash.
- Regulación del borde de ataque o del borde de fuga configurada por el interruptor DIP.
- El brillo mínimo se puede configurar con la tecla.
- Protección contra sobrecalentamiento, se recupera automáticamente.

Instalación:

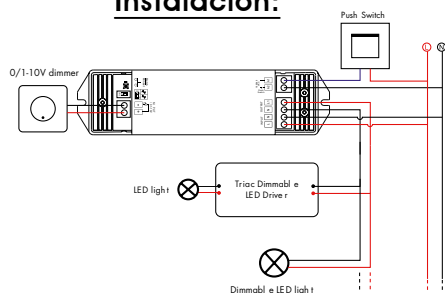

Regulador 0/1-10V A AC TRIAC 2A / Regulator 0/1-10V AC TRIAC 2A / Régulateur 0/1-10V A AC TRIAC 2A

Control / Input Signal / Signal d'entrée	RF +0/1-10V+AC Push
Voltaje de entrada / Input Voltage / Tension d'entrée	AC100-240V
Corriente de salida / Output Current / Courant de sortie	AC 100-240V
Salida de señal Output signal	Max 2A
Tamaño / Size / Taille	L175 x W45 x H27 mm
Distancia / Distance / Distance	30M
Temperatura de trabajo / Working Temperature / Température de fonctionnement	-30°C~+55°C
PVP	94,95€

- RF +0/1-10V AC Push Phase Cut Dimmer, 1 channel output.
- For dimming and changing single color dimmable LED lamps, traditional incandescent and halogen lighting.
- Support 2.4G RF single zone or multi zone dimming remote control.
- Compatible with active or passive dimmer 0-10V, 1-10V.
- Connect with external push switch to achieve on/off and 0-100% dimming function.
- 256 levels 0-100% smooth dimming without flash.
- Regulation of the leading edge or the trailing edge configured by the DIP switch.
- The minimum brightness can be set with the key.
- Overheat protection, recovers automatically.

- Gradateur RF +0/1-10V AC Push Phase Cut, sortie 1 canal.
- Pour la gradation et le changement des lampes LED à gradation monochrome, éclairage traditionnel à incandescence et halogène.
- Prise en charge de la télécommande de gradation à zone unique ou multizone RF 2.4G.
- Compatible avec variateur actif ou passif 0-10V, 1-10V.
- Connectez-vous avec un interrupteur à poussoir externe pour obtenir une fonction marche/arrêt et une fonction de gradation de 0 à 100 %.
- 256 niveaux de gradation fluide de 0 à 100 % sans flash.
- Régulation du front montant ou du front descendant configuré par le DIP switch.
- La luminosité minimale peut être réglée avec la touche.
- Protection contre la surchauffe, récupère automatiquement.

CONTROLADOR DE LUZ DE ESCALERA CON SENSOR PIR

STAIRWAY LIGHT CONTROLLER WITH PIR SENSOR

CONTRÔLEUR D'ÉCLAIRAGE D'ESCALIER AVEC CAPTEUR PIR

Ref.: **88574**



Voltaje de entrada / Input Voltage / Tension d'entrée	5-24VDC
Tensión de salida / Output Voltage / Tension de sortie	32 x (5-24)VDC
Corriente de salida / Output Current	32CH, 1A/CH
Potencia de salida / Output Power / Puissance de sortie	32x24W
Tamaño / Size / Taille	L186 x W86 x H25 mm
Temperatura de trabajo / Working Temperature / Température de fonctionnement	-30°C~ +55°C
PVP	229,95€

- Controlador de luz de escalera con sensor PIR de funciones múltiples con sensor de luz natural.
- Tira de LED de bajo voltaje con salida de voltaje constante de 32 canales, máx. 1A de corriente por canal.
- Salida de señal SPI (TTL) de 2 grupos, se pueden configurar 27 tipos de tira LED RGB digital IC, tipo IC y orden R / G / B. Circuitos integrados compatibles: TM1803, TM1804, TM1809, TM1812, UCS1903, UCS1909, UCS1912, UCS2903, UCS2909, UCS2912, WS2811, WS2812, TM1829, TM1914A, GW6205, GS8206, LPD6803, LPD1101, D705, UCS6909, UCS6912, LPD8803, LPD8806, WS2801, WS2803, P9813, SK9822.
- Fácil manejo con pantalla OLED y 3 botones.
- cuatro modos de luz de trabajo seleccionables.
- Dos controladores de luz de escalera pueden conectarse en cascada.
- Modo de color múltiple incorporado, velocidad ajustable de 1 a 8 grados.
- El interruptor de empuje también puede ser como entrada de señal de inducción.
- Con función de autoprueba rápida

- Multi-function PIR sensor stair light controller with daylight sensor.
- 32 channel constant voltage output low voltage LED strip, max. 1A current per channel.
- 2 groups SPI (TTL) signal output, 27 kinds of IC digital RGB LED strip can be set, IC type and R/G/B order. Supported ICs: TM1803, TM1804, TM1809, TM1812, UCS1903, UCS1909, UCS1912, UCS2903, UCS2909, UCS2912, WS2811, WS2812, TM1829, TM1914A, GW6205, GS8206, LPD6803, LPD1101, D705, UCS6909, UCS6912, LPD8803, LPD8806, WS2801, WS2803, P9813, SK9822.
- Easy handling with OLED screen and 3 buttons.
- four selectable work light modes.
- Two stair light controllers can be cascaded.
- Built-in multiple color mode, speed adjustable from 1 to 8 grades.
- The push switch can also be as induction signal input.
- With quick self-test function

- Contrôleur d'éclairage d'escalier à capteur PIR multifonction avec capteur de lumière du jour.
- Bande LED basse tension à sortie de tension constante 32 canaux, max. Courant 1A par canal.
- Sortie de signal SPI (TTL) de 2 groupes, 27 types de bande LED RVB numérique IC peuvent être définis, type IC et ordre R/G/B. CI pris en charge : TM1803, TM1804, TM1809, TM1812, UCS1903, UCS1909, UCS1912, UCS2903, UCS2909, UCS2912, WS2811, WS2812, TM1829, TM1914A, GW6205, GS8206, LPD6803, LPD1101, D705, UCS6909, UCS6912, LPD8803, LPD8806, WS2801, WS2803, P9813, SK9822.
- Prise en main facile avec écran OLED et 3 boutons.
- quatre modes d'éclairage de travail sélectionnables.
- Deux contrôleurs d'éclairage d'escalier peuvent être montés en cascade.
- Mode de couleurs multiples intégré, vitesse réglable de 1 à 8 niveaux.
- L'interrupteur à poussoir peut également servir d'entrée de signal d'induction.
- Avec fonction d'autotest rapide

2 pcs

Mechanical Structures and Installations

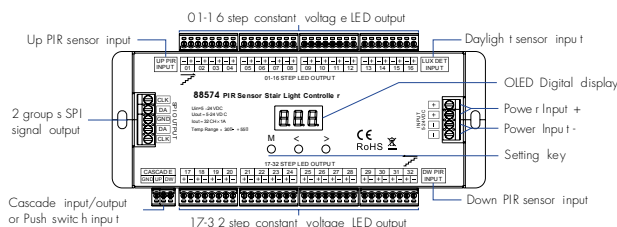

Accessories



Wiring Diagram

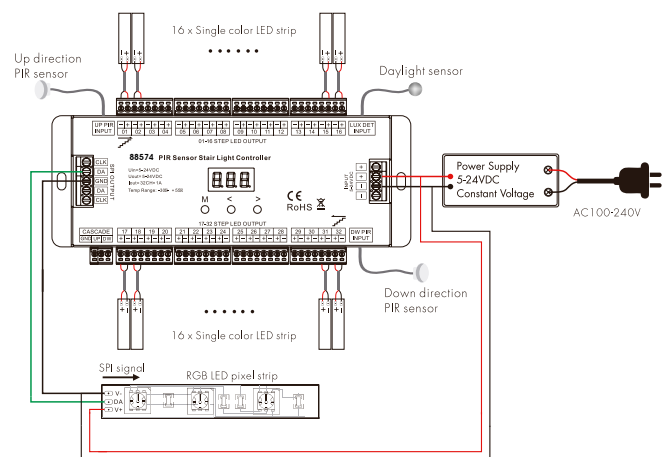

Note: The LED pixel strip also use separate power supply.

SMART DRIVER REGULABLE 15A

DIMMABLE SMART DRIVER 15A

DRIVER INTELLIGENT GRADABLE 15A

Ref.: **88530**



- Interfaz de atenuación: RF inalámbrico, AC Pusch-Dim.
- Combine con el control remoto de un solo color 2.4G de Skydance, un controlador LED RF acepta hasta 10 controles remotos.
- Entrada de CA universal / rango completo.
- Salida de corriente constante de 1 canal, corriente configurable mediante interruptor DIP.
- Función PFC activa incorporada: 0,95 Typ.
- Función de transmisión automática: el controlador LED transmite automáticamente la señal a otro controlador LED con una distancia de control de 30 m.
- Sincronizar en múltiples números de controladores LED.
- Protección contra sobrecalentamiento / sobrecarga / cortocircuito, se recupera automáticamente.
- Estuche protector de plástico completo.
- Adecuado para aplicaciones de iluminación LED en interiores.

Instalación:

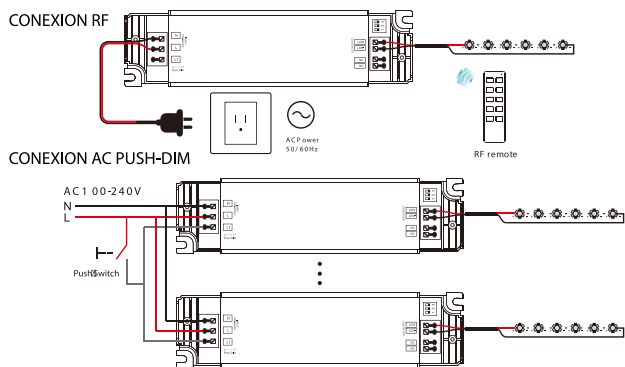

Control / Input Signal / Signal d'entrée	RF 2.4GHz+ Push Dim
Voltaje de entrada / Input Voltage / Tension d'entrée	100-265VAC
Tensión de salida / Output Voltage / Tension de sortie	10-45VDC
Corriente de salida / Output Current / Courant de sortie	150-700mA
Potencia de salida / Output Power / Puissance de sortie	Max 15W
Tamaño / Size / Taille	L51 x W41 x H30 mm
Distancia / Distance / Distance	30M
Temperatura de trabajo / Working Temperature / Température de fonctionnement	-30°C~+55°C
PVP	49,95€

- Dimming Interface: Wireless RF, AC Push-Dim.
- Combine with Skydance 2.4G single color remote control, one RF LED controller accepts up to 10 remote controls.
- Universal AC input / full range.
- 1 channel constant current output, configurable current by DIP switch.
- Built-in active PFC function: 0.95 Typ.
- Automatic transmission function: the LED controller automatically transmits the signal to another LED controller with a control distance of 30m.
- Synchronize on multiple numbers of LED drivers.
- Overheat/overload/short circuit protection, recovers automatically.
- Full plastic protective case.
- Suitable for indoor LED lighting applications.

- Interface de gradation : RF sans fil, AC Push-Dim.
- À combiner avec la télécommande monocolore Skydance 2.4G, un contrôleur LED RF accepte jusqu'à 10 télécommandes.
- Entrée AC universelle / gamme complète.
- Sortie courant constant 1 canal, courant configurable par commutateur DIP.
- Fonction PFC active intégrée : 0,95 Typ.
- Fonction de transmission automatique : le contrôleur LED transmet automatiquement le signal à un autre contrôleur LED avec une distance de contrôle de 30 m.
- Synchroniser sur plusieurs nombres de pilotes LED.
- Protection contre la surchauffe/surcharge/court-circuit, récupère automatiquement.
- Etui de protection complet en plastique.
- Convient aux applications d'éclairage intérieur à LED.

SMART DRIVER REGULABLE 36A

DIMMABLE SMART DRIVER 36A

DRIVER INTELLIGENT GRADABLE 36A

Ref.: **88532**



- Interfaz de atenuación: RF inalámbrico, AC Pusch-Dim.
- Combine con el control remoto de un solo color 2.4G de Skydance, un controlador LED RF acepta hasta 10 controles remotos.
- Entrada de CA universal / rango completo.
- Salida de corriente constante de 1 canal, corriente configurable mediante interruptor DIP.
- Función PFC activa incorporada: 0,95 Typ.
- Función de transmisión automática: el controlador LED transmite automáticamente la señal a otro controlador LED con una distancia de control de 30 m.
- Sincronizar en múltiples números de controladores LED.
- Protección contra sobrecalentamiento / sobrecarga / cortocircuito, se recupera automáticamente.
- Estuche protector de plástico completo.
- Adecuado para aplicaciones de iluminación LED en interiores.

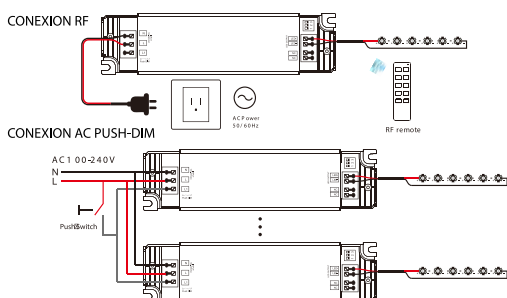

Control / Input Signal / Signal d'entrée	RF 2.4GHz+ Push Dim
Voltaje de entrada / Input Voltage / Tension d'entrée	100-265VAC
Tensión de salida / Output Voltage / Tension de sortie	10-52VDC
Corriente de salida / Output Current / Courant de sortie	350-1200mA
Potencia de salida / Output Power / Puissance de sortie	Max 36W
Tamaño / Size / Taille	L168,5 x W44 x H30 mm
Distancia / Distance / Distance	30M
Temperatura de trabajo / Working Temperature / Température de fonctionnement	-30°C~+55°C
PVP	79,95€

- Dimming Interface: Wireless RF, AC Push-Dim.
- Combine with Skydance 2.4G single color remote control, one RF LED controller accepts up to 10 remote controls.
- Universal AC input / full range.
- 1 channel constant current output, configurable current by DIP switch.
- Built-in active PFC function: 0.95 Typ.
- Automatic transmission function: the LED controller automatically transmits the signal to another LED controller with a control distance of 30m.
- Synchronize on multiple numbers of LED drivers.
- Overheat/overload/short circuit protection, recovers automatically.
- Full plastic protective case.
- Suitable for indoor LED lighting applications.

- Interface de gradation : RF sans fil, AC Push-Dim.
- À combiner avec la télécommande monocolore Skydance 2.4G, un contrôleur LED RF accepte jusqu'à 10 télécommandes.
- Entrée AC universelle / gamme complète.
- Sortie courant constant 1 canal, courant configurable par commutateur DIP.
- Fonction PFC active intégrée : 0,95 Typ.
- Fonction de transmission automatique : le contrôleur LED transmet automatiquement le signal à un autre contrôleur LED avec une distance de contrôle de 30 m.
- Synchroniser sur plusieurs nombres de pilotes LED.
- Protection contre la surchauffe/surcharge/court-circuit, récupère automatiquement.
- Etui de protection complet en plastique.
- Convient aux applications d'éclairage intérieur à LED.

SMART DRIVER REGULABLE 50A DIMMABLE SMART DRIVER 50A DRIVER INTELLIGENT DIMMABLE 50A

Ref.: **88533**



Control / Input Signal / Signal d'entrée	RF 2.4GHz+Push Dim
Voltaje de entrada / Input Voltage / Tension d'entrée	100-265VAC
Tensión de salida / Output Voltage / Tension de sortie	10-52VDC
Corriente de salida / Output Current / Courant de sortie	500-1750mA
Potencia de salida / Output Power / Puissance de sortie	Max 50W
Tamaño / Size / Taille	L133 x W88 x H30 mm
Distancia / Distance / Distance	30M
Temperatura de trabajo / Working Temperature / Température de fonctionnement	-30°C ~ +55°C
PVP	98,95€

- Interfaz de atenuación: RF inalámbrico, AC Pusch-Dim.
- Combine con el control remoto de un solo color 2.4G de Skydance, un controlador LED RF acepta hasta 10 controles remotos.
- Entrada de CA universal / rango completo.
- Salida de corriente constante de 1 canal, corriente configurable mediante interruptor DIP.
- Función PFC activa incorporada: 0,95 Typ.
- Función de transmisión automática: el controlador LED transmite automáticamente la señal a otro controlador LED con una distancia de control de 30 m.
- Sincronizar en múltiples números de controladores LED.
- Protección contra sobrecalentamiento / sobrecarga / cortocircuito, se recupera automáticamente.
- Estuche protector de plástico completo.
- Adecuado para aplicaciones de iluminación LED en interiores.

- Dimming Interface: Wireless RF, AC Push-Dim.
- Combine with Skydance 2.4G single color remote control, one RF LED controller accepts up to 10 remote controls.
- Universal AC input / full range.
- 1 channel constant current output, configurable current by DIP switch.
- Built-in active PFC function: 0.95 Typ.
- Automatic transmission function: the LED controller automatically transmits the signal to another LED controller with a control distance of 30m.
- Synchronize on multiple numbers of LED drivers.
- Overheat/overload/short circuit protection, recovers automatically.
- Full plastic protective case.
- Suitable for indoor LED lighting applications.

- Interface de gradation : RF sans fil, AC Push-Dim.
- À combiner avec la télécommande monocolore Skydance 2.4G, un contrôleur LED RF accepte jusqu'à 10 télécommandes.
- Entrée AC universelle / gamme complète.
- Sortie courant constant 1 canal, courant configurable par commutateur DIP.
- Fonction PFC active intégrée : 0,95 Typ.
- Fonction de transmission automatique : le contrôleur LED transmet automatiquement le signal à un autre contrôleur LED avec une distance de contrôle de 30 m.
- Synchroniser sur plusieurs nombres de pilotes LED.
- Protection contre la surchauffe/surcharge/court-circuit, récupère automatiquement.
- Etui de protection complet en plastique.
- Convient aux applications d'éclairage intérieur à LED.

CONEXION AC PUSH-DIM

CONEXION RF

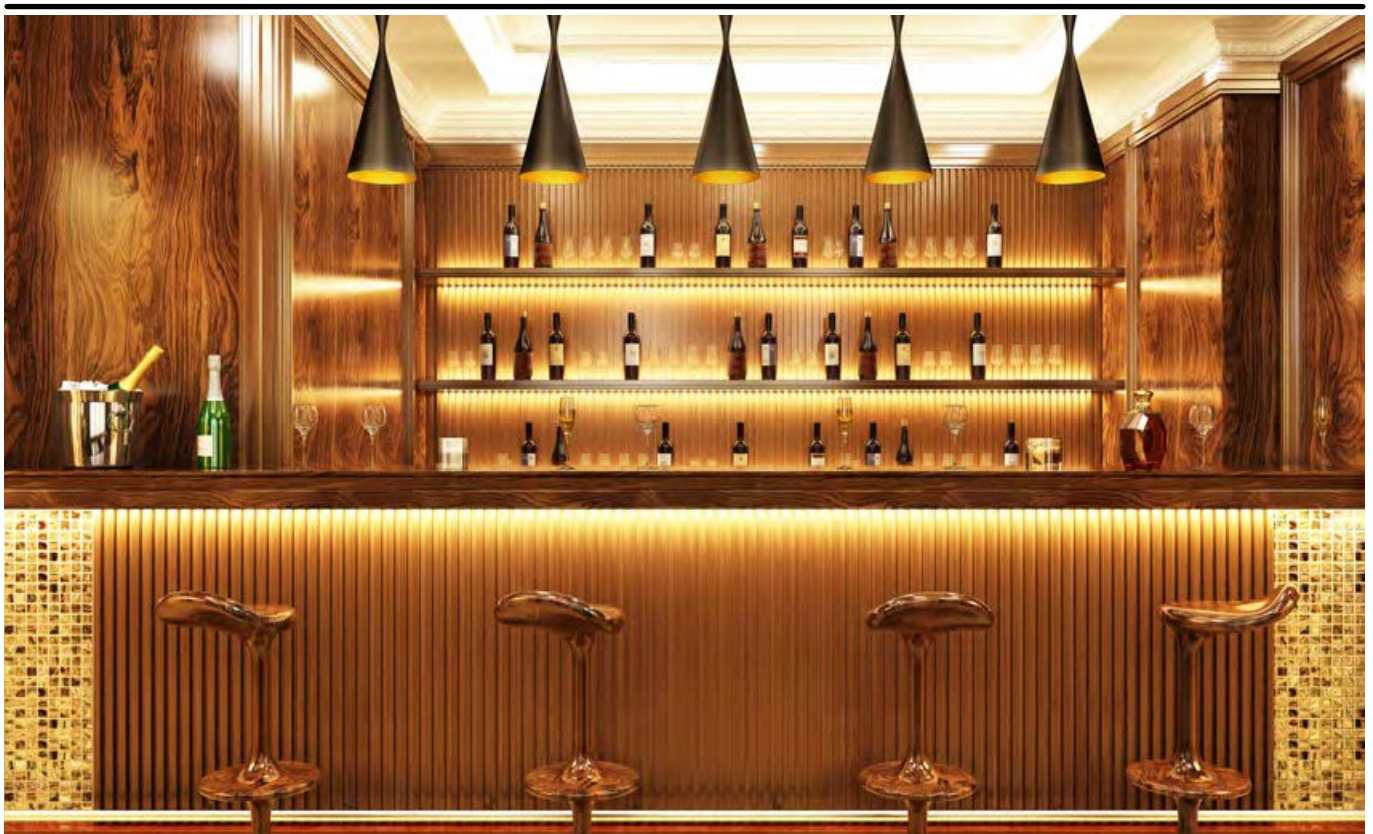
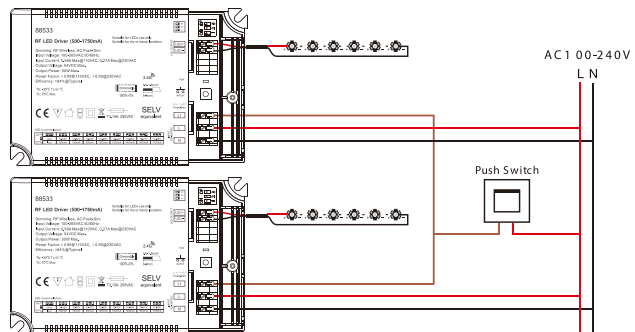
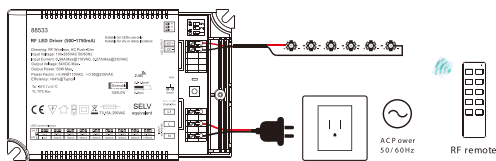

SENSOR ON/OFF+DIMMER PARA TIRA LED ON/OFF+DIMMER SENSOR FOR LED STRIP CAPTEUR ON/OFF+DIMMER POUR BANDE LED

Ref.: **88540**



- 1 canal de voltaje constante de un solo color LED mini sensor dimmer e interruptor para perfiles de aluminio.
- Operación táctil de alta sensibilidad con indicador LED.
- 3A por canal, la salida se conecta con una tira LED de un solo color de 5 metros, potencia máxima de salida 75W.
- 0-100% de atenuación suave sin flash.
- Los medios en el resorte táctil pueden ser una cubierta de PC, tablero acrílico o vidrio espejo.
- La pasta 3M en la parte inferior de la PCBA facilita la instalación y la seguridad.
- Bajo costo y alta estabilidad.

- 1 channel constant voltage single color LED mini sensor dimmer and switch for aluminum profiles.
- High sensitivity touch operation with LED indicator.
- 3A per channel, the output connects with a 5 meter single color LED strip, maximum output power 75W.
- 0-100% smooth dimming without flash.
- The media in the tactile spring can be PC cover, acrylic board or mirror glass.
- 3M paste on the bottom of the PCBA makes it easy to install and safe.
- Low cost and high stability.

- Mini gradateur et interrupteur à capteur à LED monochrome à tension constante à 1 canal pour profils en aluminium.
- Fonctionnement tactile haute sensibilité avec indicateur LED.
- 3A par canal, la sortie se connecte à une bande LED monochrome de 5 mètres, puissance de sortie maximale 75W.
- Gradation fluide de 0 à 100 % sans flash.
- Le support du ressort tactile peut être une couverture PC, un panneau acrylique ou un verre miroir.
- La pâte 3M au bas du PCBA le rend facile à installer et sûr.
- Faible coût et grande stabilité.

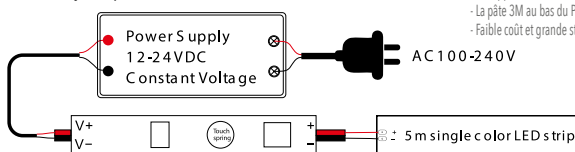
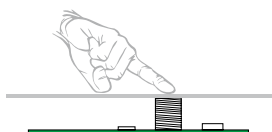

SENSOR DE PUERTAS DIMMABLE DOOR SENSOR CAPTEUR DE PORTE

Ref.: **88541**



- Interruptor del sensor de puerta, conectado directamente a la tira LED de bajo voltaje.
- Cuando la puerta se abre, o no hay ningún obstáculo por delante, la tira se enciende gradualmente.
- Cuando la puerta se cierra o hay un obstáculo por delante, la tira se apaga gradualmente.
- Corriente de salida máxima de 4A, potencia de salida máxima de 96W a 24V.
- Generalmente instalado en la carcasa de la tira de lámpara de aluminio.
- La pasta 3M en la parte inferior de la PCBA facilita la instalación y la seguridad.
- Bajo costo y alta estabilidad.
- Ampliamente utilizado en luces de armario.

- Door sensor switch, directly connected to the low voltage LED strip.
- When the door is opened, or there is no obstacle ahead, the strip turns on gradually.
- When the door closes or there is an obstacle ahead, the strip gradually turns off.
- 4A maximum output current, 96W maximum output power at 24V.
- Generally installed in the housing of the aluminum lamp strip.
- 3M paste on the bottom of the PCBA makes it easy to install and safe.
- Low cost and high stability.
- Widely used in cabinet lights

- Commutateur de capteur de porte, directement connecté à la bande LED basse tension.
- Lorsque la porte est ouverte, ou qu'il n'y a pas d'obstacle devant, la bande s'allume progressivement.
- Lorsque la porte se ferme ou qu'il y a un obstacle devant, le bandeau s'éteint progressivement.
- Courant de sortie maximum 4A, puissance de sortie maximum 96W à 24V.
- Généralement installé dans le boîtier de la bande de lampe en aluminium.
- La pâte 3M au bas du PCBA le rend facile à installer et sûr.
- Faible coût et grande stabilité.
- Largement utilisé dans les lampes d'armoires.

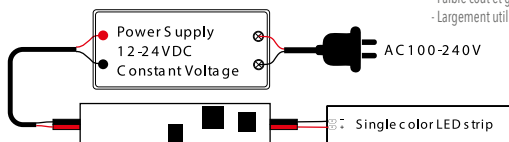
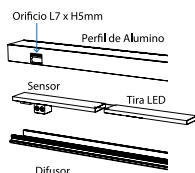

SENSOR DE MOVIMIENTO PARA PERFIL MOTION SENSOR FOR PROFILE CAPTEUR DE MOUVEMENT POUR PROFIL

Ref.: **88542**



- Interruptor del sensor de movimiento PIR, conectado directamente a la tira LED de bajo voltaje.
- Cuando personas u objetos ingresan al campo sensible, la tira se enciende.
- Cuando estos salen del campo sensible, la tira se apaga después de 30 segundos.
- Corriente de salida máxima de 3A, potencia de salida máxima de 72W a 24V.
- Generalmente instalado en la carcasa de la tira de lámpara de aluminio.
- La pasta 3M en la parte inferior de la PCBA facilita la instalación y la seguridad.
- Bajo costo y alta estabilidad.
- Ampliamente utilizado en lámparas de mesa, lámparas de dormitorio, lces de armario, etc.

- PIR motion sensor switch, directly connected to the low voltage LED strip.
- When people objects enter the sensitive field, the strip lights up.
- When these leave the sensitive field, the strip turns off after 30 seconds.
- 3A max output current, 72W max output power at 24V.
- Generally installed in the housing of the aluminum lamp strip.
- 3M paste on the bottom of the PCBA makes it easy to install and safe.
- Low cost and high stability.
- Widely used in table lamps, bedroom lamps, cabinet lights, etc

- Commutateur de capteur de mouvement PIR, directement connecté à la bande LED basse tension.
- Lorsque des personnes objets entrent dans le champ sensible, la bande s'allume.
- Lorsque ceux-ci quittent le champ sensible, la bande s'éteint au bout de 30 secondes.
- Courant de sortie max 3A, puissance de sortie max 72W à 24V.
- Généralement installé dans le boîtier de la bande de lampe en aluminium.
- La pâte 3M au bas du PCBA le rend facile à installer et sûr.
- Faible coût et grande stabilité.
- Largement utilisé dans les lampes de table, les lampes de chambre, les lampes d'armoire, etc.

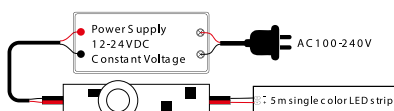

MANDO 1 ZONA 1 ZONE CONTROL CONTRÔLE 1 ZONE

Ref.: **88515**



Mando 1 escena / 1 scene command / 1 commande de scène

Control / Input Signal / Signal d'entrée	RF (2.4GHz)
Tensión de trabajo / Controls Working voltage / Tension de fonctionnement	3VDC/CR2032
Tamaño / Size / Taille	L100 x W47 x H8 mm
Distancia / Distance / Distance	30M
Temperatura de trabajo / Working Temperature / Température de fonctionnement	-30°C~+55°C
PVP	28,95€

- Aplicar a un controlador LED de un solo color o de dos colores.
- Cada control remoto puede coincidir con uno o más receptores.
- Funciona con pilas CR2032.
- Funciona con luz indicadora LED.
- Apply to a single color or two color LED driver.
- Each remote can match one or more receivers.
- Works with CR2032 batteries.
- Works with LED indicator light.

- Appliquer à un pilote de LED monocouleur ou bicolore.
- Chaque télécommande peut correspondre à un ou plusieurs récepteurs.
- Fonctionne avec des piles CR2032.
- Fonctionne avec voyant lumineux LED.

Instalación:

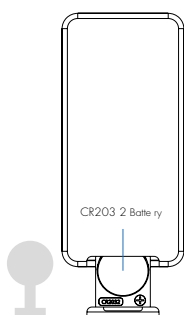

Nota: Antes del primer uso, retire la película protectora de la batería.

Función:



- On/Off
- 30s Apaga la luz después de 30s, una pulsación larga de 2s apagará la luz después de 60s.
- 50% de brillo
- 10% de brillo para luz nocturna pequeña
- + Brillo
- Brillo

Brillo +/-: Presione brevemente 10 niveles, presione prolongadamente 1-6s para un ajuste continuo de 256 niveles.

MANDO 1 ZONA 1 ZONE CONTROL CONTRÔLE 1 ZONE

Ref.: **88516**



Mando 1 escena / 1 scene command / 1 commande de scène

Control / Input Signal / Signal d'entrée	RF (2.4GHz)
Tensión de trabajo / Controls Working voltage / Tension de fonctionnement	3VDC/CR2032
Tamaño / Size / Taille	L139 x W36 x H11 mm
Distancia / Distance / Distance	30M
Temperatura de trabajo / Working Temperature / Température de fonctionnement	-30°C~+55°C
PVP	39,95€

- Aplicar al controlador de un solo color.
- Diapositiva táctil de ajuste de color ultra sensible.
- Cada control remoto puede coincidir con uno o más receptores.
- Funciona con pilas CR2032.
- Funciona con luz indicadora LED.
- Imán en la parte posterior que se puede pegar fácilmente en el soporte posterior o en cualquier superficie metálica.

- Apply to the controller of a single color.
- Ultra sensitive color adjustment touch slide.
- Each remote can match one or more receivers.
- Works with CR2032 batteries.
- Works with LED indicator light.
- Magnet on the back that can be easily stuck on the back stand or any metal surface.

- Appliquer au contrôleur d'une seule couleur.
- Glissière tactile de réglage des couleurs ultra sensible.
- Chaque télécommande peut correspondre à un ou plusieurs récepteurs.
- Fonctionne avec des piles CR2032.
- Fonctionne avec voyant lumineux LED.
- Aimant à l'arrière qui peut être facilement collé sur le support arrière ou sur toute surface métallique.

Instalación:

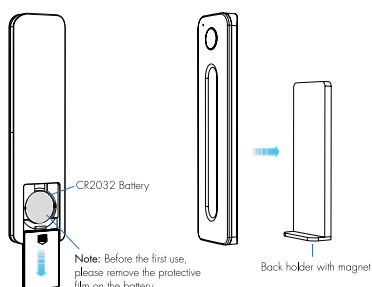

Note: Before the first use, please remove the protective film on the battery.

Función:

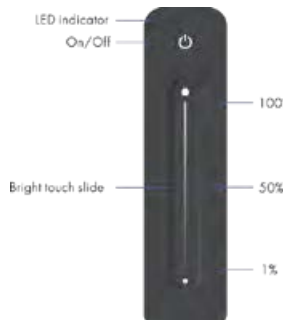

Información de seguridad

1. Lea todas las instrucciones detenidamente antes de comenzar esta instalación.
2. Al instalar la batería, preste atención a la polaridad positiva y negativa de la batería. Mucho tiempo sin el control remoto, retire la batería. Cuando la distancia remota se vuelve más pequeña e insensible, reemplace la batería.
3. Si no hay respuesta del receptor, vuelva a hacer coincidir el control remoto.
4. Maneje suavemente el control remoto, tenga cuidado con las caídas.
5. Solo para uso en interiores y lugares secos.

CONTROL INALAMBRICO DIMER 1 ZONA (PULSADOR) WIRELESS CONTROL DIMER 1 ZONE (PUSHBUTTON) COMMANDE SANS FIL DIMER 1 ZONE (BOUTON-POUSSOIR)

Ref.: **88570**



- Aplicar a un controlador RF LED de un solo color o controlador de atenuación RF.
- Conecte con el interruptor de presión para lograr la función de atenuación de encendido/apagado y 0-100%.
- Adopte tecnología inalámbrica de 2,4 GHz, distancia remota de hasta 30 m.
- Cada control remoto puede coincidir con uno o más receptores.
- Botón CR2032 alimentado por pilas.
- Apply to single color RF LED driver or RF dimming driver.
- Connect with pressure switch to achieve on/off and 0-100% dimming function.
- Adopt 2.4GHz wireless technology, remote distance up to 30m.
- Each remote can match one or more receivers.
- CR2032 button battery powered.

Control inalámbrico dimer 1 zona / Wireless control dimmer 1 zone / Variateur de commande sans fil 1 zone

Control / Input Signal / Signal d'entrée	RF (2.4GHz)
Tensión de trabajo / Controls Working voltage / Tension de fonctionnement	3VDC/CR2032
Tamaño / Size / Taille	L17 x W43 x H17 mm
Distancia / Distance / Distance	30M
Temperatura de trabajo / Working Temperature / Température de fonctionnement	-30°C~+55°C
PVP	44,95€

Función de interruptor pulsador:

1. Pulsación corta: enciende / apaga la luz.
2. Pulsación larga (1-6 s): cuando la luz está encendida, aumente o disminuya el brillo de forma continua.

Intalación de batería

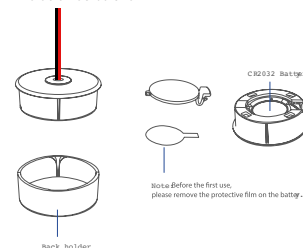

- Appliquer au pilote de LED RF monochrome ou au pilote de gradation RF.
- Connectez-vous avec un pressostat pour obtenir une fonction marche/arrêt et une fonction de gradation de 0 à 100 %.
- Adoptez la technologie sans fil 2,4 GHz, distance à distance jusqu'à 30 m.
- Chaque télécommande peut correspondre à un ou plusieurs récepteurs.
- Pile bouton CR2032 alimentée.

CONTROL INALAMBRICO DIMER 1 ZONA (PULSADOR) WIRELESS CONTROL DIMER 1 ZONE (PUSHBUTTON) COMMANDE SANS FIL DIMER 1 ZONE (BOUTON-POUSSOIR)

Ref.: **88571**



- Aplicar al controlador LED de un solo color.
- Cada control remoto puede coincidir con uno o más receptores.
- Funciona con pilas CR2032.
- Funciona con luz indicadora LED.
- Imán en la parte posterior que se puede pegar fácilmente en cualquier superficie metálica.
- Apply to single color LED driver.
- Each remote can match one or more receivers.
- Works with CR2032 batteries.
- Works with LED indicator light.
- Magnet on the back that can be easily stuck on any metal surface.

Control inalámbrico dimer 1 zona / Wireless control dimmer 1 zone / Variateur de commande sans fil 1 zone

Control / Input Signal / Signal d'entrée	RF (2.4GHz)
Tensión de trabajo / Controls Working voltage / Tension de fonctionnement	3VDC/CR2032
Tamaño / Size / Taille	L17 x W43 x H17 mm
Distancia / Distance / Distance	30M
Temperatura de trabajo / Working Temperature / Température de fonctionnement	-30°C~+55°C
PVP	44,95€

- Appliquer au pilote de LED à une seule couleur.
- Chaque télécommande peut correspondre à un ou plusieurs récepteurs.
- Fonctionne avec des piles CR2032.
- Fonctionne avec voyant lumineux LED.
- Aimant au dos qui peut être facilement collé sur n'importe quelle surface métallique.

Estructuras e instalaciones mecánicas



MANDO MONOCOLOR 4 ZONAS 4 ZONE SINGLE COLOR CONTROL COMMANDE DE COULEUR UNIQUE À 4 ZONES

Ref.: **88507**



- Encendido / apagado:** Presione brevemente para encender / apagar la luz de todas las zonas. 1,2,3,4 zona: pulse brevemente, seleccione y encienda la luz de zona, mantenga pulsado 2s apague la luz de zona. Presione brevemente la tecla de varias zonas rápidamente, se seleccionará de forma sincrónica varias zonas de forma sincronizada. **Rueda brillante:** toque para cambiar el brillo de la zona actual. **Brillo +/-:** Ajusta el brillo para la zona seleccionada actual, pulse brevemente 10 niveles, mantenga pulsado 1-5s para un ajuste continuo de 256 niveles. **3 Escena:** presione brevemente para recuperar la escena, mantenga presionado 2 segundos para guardar el estado actual en la escena. Recuperación de 4 zonas o guardar de forma sincrónica.

Mando monocolor 4 zonas / 4-zone monochrome control / Commande monochrome 4 zones

Control / Input Signal / Signal d'entrée	RF (2.4GHz)
Tensión de trabajo / Controls Working voltage / Tension de fonctionnement	3VDC/CR2032
Tamaño / Size / Taille	L107 x W58,5 x H9 mm
Distancia / Distance / Distance	30M
PVP	33,95€

- Aplicar a un controlador LED de un solo color, controlador de atenuación o lámpara inteligente.
- Rueda táctil de ajuste de color ultra sensible.
- Cada control remoto puede coincidir con uno o más receptores.
- CR2032 alimentado por batería.
- Apply to a single color LED driver, dimming driver or smart lamp.
- Touch wheel for ultra sensitive color adjustment.
- Each remote can match one or more receivers.
- CR2032 battery powered.

- Appliquer à un pilote de LED à une seule couleur, un pilote de gradation ou une lampe intelligente.
- Molette tactile pour un réglage ultra sensible des couleurs.
- Chaque télécommande peut correspondre à un ou plusieurs récepteurs.
- Alimenté par pile CR2032.

MANDO MONOCOLOR 4 ZONAS 4 ZONE SINGLE COLOR CONTROL COMMANDE DE COULEUR UNIQUE À 4 ZONES

Ref.: **88508**



- Aplicar a controlador LED de un solo color, o color dual.
- Cada control remoto puede coincidir con uno o más receptores.
- CR2032 alimentado por batería.
- Imán en la parte posterior que se puede pegar fácilmente en el soporte trasero o en cualquier superficie metálica.

- Apply to single color, or dual color LED driver.
- Each remote can match one or more receivers.
- CR2032 battery powered.
- Magnet on the back that can be easily stuck on the back mount or any metal surface.

- Appliquer sur un pilote de LED monochrome ou bicolore.
- Chaque télécommande peut correspondre à un ou plusieurs récepteurs.
- Alimenté par pile CR2032.
- Aimant à l'arrière qui peut être facilement collé sur le support arrière ou sur toute surface métallique.

Mando monocolor 4 zonas / 4-zone monochrome control / Commande monochrome 4 zones

Control / Input Signal / Signal d'entrée	RF (2.4GHz)
Tensión de trabajo / Controls Working voltage / Tension de fonctionnement	3VDC/CR2032
Tamaño / Size / Taille	L135 x W40 x H11 mm
Distancia / Distance / Distance	30M
PVP	34,95€

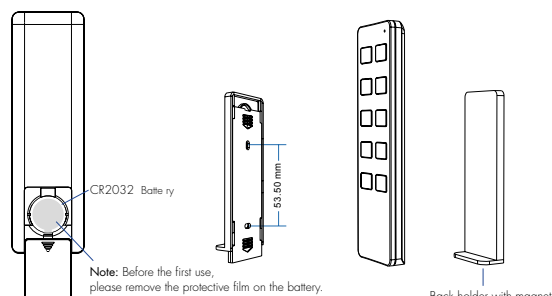

Note: Before the first use, please remove the protective film on the battery.

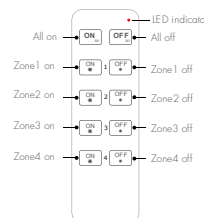

- Todo encendido:** enciende todas las luces de 4 zonas.
- Todo apagado:** apaga todas las luces de 4 zonas.
- Zona 1-4 en:** Pulsar brevemente encender la luz de zona. Mantener pulsado 1-6s aumenta el brillo continuamente.
- Zona 1-4 desactivada:** Pulse brevemente apagar la luz de zona, una pulsación larga 1-6s disminuye el brillo continuamente

MANDO RGB+RGBW 4 ZONAS RGB+RGBW CONTROLLER 4 ZONES CONTRÔLEUR RVB+RGBW 4 ZONES

Ref.: **88509**

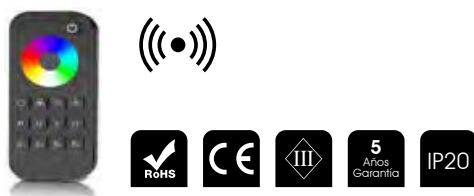

- Aplicar al controlador LED RGB + RGBW.
- Rueda táctil de ajuste de color ultra sensible.
- Cada control remoto puede coincidir con uno o más receptores.
- AAAx2 alimentado por batería.
- Imán en la parte posterior que se puede pegar fácilmente en el soporte posterior o en cualquier superficie metálica.

- Apply to RGB + RGBW LED controller.
- Ultra sensitive color adjustment touch wheel.
- Each remote can match one or more receivers.
- AAAx2 battery powered.
- Magnet on the back that can be easily stuck on the back stand or any metal surface.

- Appliquer au contrôleur LED RGB + RGBW.
- Molette tactile de réglage des couleurs ultra sensible.
- Chaque télécommande peut correspondre à un ou plusieurs récepteurs.
- Alimenté par pile AAAx2.
- Aimant à l'arrière qui peut être facilement collé sur le support arrière ou sur toute surface métallique.

Mando RGB+RGBW 4 zonas / RGB+RGBW control 4 zones / Contrôle RGB+RGBW 4 zones

Control / Input Signal / Signal d'entrée	RF (2.4GHz)
Tensión de trabajo / Controls Working voltage / Tension de fonctionnement	3VDC/CR2032
Tamaño / Size / Taille	L122 x W53 x H17,5 mm
Distancia / Distance / Distance	30M
PVP	44,95€



- : Pulse brevemente para encender/apagar la luz de todas las zonas.
- : Toque para cambiar el color RGB estático de la zona actual.
- 1 2 3 4** : Presione brevemente, seleccione y encienda la luz de zona, mantenga pulsado 2s apagar la luz de zona. Pulse brevemente la tecla de zona múltiple rápidamente, seleccionará múltiples zonas de forma sincrónica.
- R G B** : Pulse brevemente el color rojo, verde o azul directamente. una pulsación larga 1-6s ajusta el brillo R/G/B continuamente
- W** : Para la luz RGB, presione brevemente para encender/apagar el blanco (mezcla RGB), presione prolongadamente 1-6s para ajustar la saturación continuamente, es decir, cambiar el color RGB estático actual a blanco mezclado lentamente. Para luz RGBW, presione brevemente para activar / desactivar el canal W, una pulsación larga 1-6s ajusta el brillo W continuamente, es decir, cambia la saturación agregando lentamente el color blanco.
- : Ajuste el modo dinámico para la zona seleccionada actual, Presione brevemente el siguiente modo dinámico, presione prolongadamente 2s run mode-cycle.
- : Para el color estático, ajuste el brillo, presione brevemente 10 niveles, Mantenga pulsado 1-6s para un ajuste con%no de 256 niveles. Para el modo dinámico, ajuste la velocidad, pulse brevemente 10 niveles, mantenga pulsado 2s obtener lavelocidad predeterminada.
- S1 S2** : Presione brevemente para recuperar la escena, mantenga presionado 2s para guardar el estado actual en S1 / S2. Recuperación de 4 zonas o guardar de forma sincrónica.

MANDO RGB+CCT 4 ZONAS RGB+CCT CONTROL 4 ZONES COMMANDE RVB+CCT 4 ZONES

Ref.: **88513**



- Appliquer au contrôleur LED RGB + CCT.
- Molette tactile de réglage des couleurs ultra sensible.
- Chaque télécommande peut correspondre à un ou plusieurs récepteurs.
- Alimenté par pile AAAx2.
- Aimant au dos qui peut être facilement collé.
- Sur support arrière ou toute surface métallique.



Cada zona puede coincidir con el controlador o la lámpara de un solo color, color dual (WW / CW), RGB, RGBW o RGB + CCT (WW / CW).

- 1 2 3 4 + * : De un solo color
- 1 2 3 4 + CCT : Doble color (WW/CW)
- 1 2 3 4 + RGB : RGB
- 1 2 3 4 + * : RGBW
- 1 2 3 4 + ▶ : RGB+CCT

Por ejemplo, una pulsación larga 1 + RGB para 2s establecerá la zona 1 como tipo de luz RGB. Cuando el tipo de cambio remoto es correcto, el indicador verde se enciende durante mucho tiempo.

☑ : Pulse brevemente para encender / apagar la luz de todas las zonas.

🌈 : Toque para cambiar el color RGB de la zona actual o la temperatura del color. Presione la tecla RGB o CCT para cambiar entre la rueda RGB y la CCT.

1 2 3 4 : Presione brevemente, selección y encienda la luz de zona, presione prolongadamente 2s para apagar la luz de zona.

* * : Ajustar el brillo RGB o la temperatura de color, pulse brevemente 10 niveles, mantenga pulsado 2s para obtener el brillo mínimo o máximo.

Mando RGB+CCT 4 zonas 4 zonas / RGB+RGBW control 4 zones / Contrôle RGB+RGBW 4 zones

Control / Input Signal / Signal d'entrée	RF (2.4GHz)
Tensión de trabajo / Controls Working voltage / Tension de fonctionnement	3VDC(AAAx2)
Tamaño / Size / Taille	L122 x W53 x H17,5 mm
Distancia / Distance / Distance	30M
PVP	46,95€

- Aplicar al controlador LED RGB + CCT.
- Rueda táctil de ajuste de color ultra sensible.
- Cada control remoto puede coincidir con uno o más receptores.
- AAAx2 alimentado por batería.
- Imán en la parte posterior que se puede pegar fácilmente.
- En soporte posterior o cualquier superficie metálica.

- Apply to RGB+CCT LED controller.
- Ultra sensitive color adjustment touch wheel.
- Each remote can match one or more receivers.
- AAAx2 battery powered.
- Magnet on the back that can be easily stuck.
- On rear support or any metal surface.

CCT : Para la lámpara de color dual o RGB + CCT / (WW / CW), ajuste la temperatura de color en el canal WW / CW, presione brevemente 11 niveles, presione prolongadamente para ajustar el brillo de WW + CW continuamente.

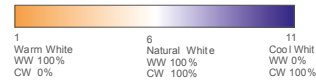

: Para la lámpara RGB, ajuste la temperatura de color mediante el canal de mezcla R / G / B, 11 niveles.

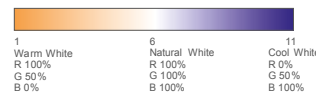

: Para la lámpara RGBW, ajuste la temperatura de color mediante el canal de mezcla W, 11 niveles.

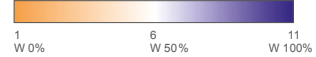

RGB : Pulsación corta para obtener 24 tipos de color RGB estático.

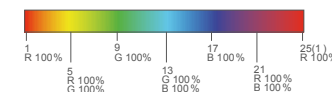

🔄 : Presione brevemente el siguiente modo dinámico, presione prolongadamente 2s.

▶ : Para el modo RGB dinámico, ajuste la velocidad, pulse brevemente 10 niveles, mantenga pulsado 2s para obtener la velocidad predeterminada. Para el color RGB estático, ajuste la saturación, es decir, cambiar el color RGB estático actual a blanco mezclados lentamente, presione brevemente 11 niveles, presione prolongadamente 1-6s para un ajuste continuo de 250 niveles.

S1 S2 : Presione brevemente para recuperar la escena, mantenga presionado 2s para guardar el estado actual en S1 / S2. Recuperación de 4 zonas o guardar de forma sincrónica.

PANEL CONTROL TACTIL PARED 4 ZONAS RGB+CCT WALL MOUNTED TOUCH PANEL RGB+CCT CONTROL 4 ZONES PANNEAU DE COMMANDE TACTILE MURAL 4 ZONES RGB+CCT

Ref.: **88585**



Panel control RGB+CCT 4 zonas 4 zonas / Panel RGB+RGBW control 4 zones / Panneau RGB+RGBW 4 zones

Control / Input Signal / Signal d'entrée	Touch key +RF (2.4GHz)
Voltaje de entrada / Input Voltage / Tension d'entrée	100 - 240 VAC
Salida de señal / Output Signal / Sortie de signal	DMX 512,RF 2.4GHz
Tamaño / Size / Taille	L112 x W112 x H50mm
Temperatura de trabajo / Working Temperature / Température de fonctionnement	-30°C~+55°C
PVP	99,95€

- Touch panel 4 zone RGB+CCT DMX512 master, can also be used as 4 zone RGB+CCT RF remote.
- DMX signal output, comply to standard DMX512 protocol, compatible with DMX decoder from any supplier.
- When used as RF remote, each zone can remote control multiple RF 2.4G LED controllers.
- Ultra sensitive high strength glass touch panel with touch color wheel in the middle.
- Smooth and accurate color adjustment by touching the color wheel.
- Touch keys with LED indicator.
- White & Black glass panel available.

Mechanical Structures and Installations

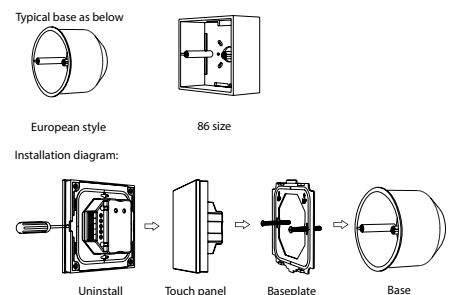
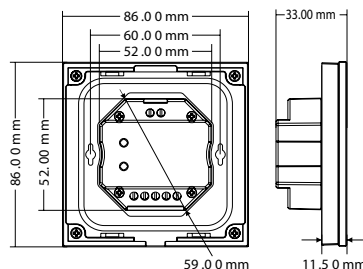
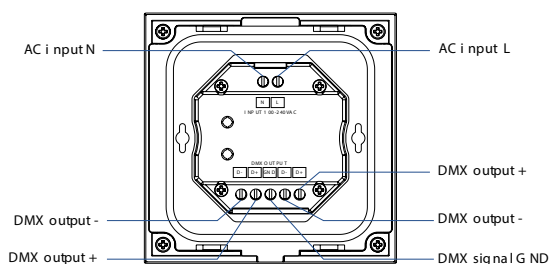

PULSADOR INALAMBRICO MONOCOLOR 2 ZONAS

WIRELESS SINGLE-COLOR 2-ZONE PUSH
BUTTON COMMANDE RVB+CCT 4 ZONES

Ref.: **88510**



- Aplíquelo en un controlador de un solo color.
- Cada control remoto puede coincidir con uno o más receptores.
- CR2032 alimentado por batería.
- Extraíble y se adhiere fácilmente a cualquier lugar, o se monta en la base del panel de uso en la pared.

- Apply it on a single color controller.
- Each remote can match one or more receivers.
- CR2032 battery powered.
- Removable and easily sticks anywhere, or mounts to the base of the panel for wall use.

- Appliquez-le sur un contrôleur de couleur unique.
- Chaque télécommande peut correspondre à un ou plusieurs récepteurs.
- Alimenté par pile CR2032.
- Amovible et se colle facilement n'importe où, ou se monte à la base du panneau pour une utilisation murale.

Pulsador inalámbrico monocolor 2 zonas / Single color wireless push button 2 zones / Bouton poussoir radio unicolore 2 zones

Control / Input Signal / Signal d'entrée	RF (2.4GHz)
Tensión de trabajo / Controls Working voltage / Tension de fonctionnement	3VDC(AAAx2)
Tamaño / Size / Taille	L86 x W86 x H14 mm
Distancia / Distance / Distance	30M
PVP	29,95€

Zona 1-2 en: Pulsar brevemente encender la luz de zona, mantenga pulsado 1-6s para aumentar el brillo de forma continua.

Zona 1-2 desactivada: Pulse brevemente apagar la luz de zona, mantenga pulsado 1-6s para disminuir el brillo de forma continua.

PULSADOR INALAMBRICO RGB

RGB WIRELESS PUSHBUTTON
BOUTON-POUSSOIR RVB SANS FIL

Ref.: **88511**



- Aplíquelo a un controlador de un solo color, color dual o RGB/RGBW LED.
- Cada control remoto puede coincidir con uno o más receptores.
- CR2032 alimentado por batería.
- Extraíble y se adhiere fácilmente a cualquier lugar, o se monta en la base del panel de uso en la pared.

- Apply to a single color, dual color or RGB/RGBW LED controller.
- Each remote can match one or more receivers.
- CR2032 battery powered.
- Removable and easily sticks anywhere, or mounts to the base of the panel for wall use.

- Appliquer à un contrôleur LED monochrome, bicolore ou RGB/RGBW.
- Chaque télécommande peut correspondre à un ou plusieurs récepteurs.
- Alimenté par pile CR2032.
- Amovible et se colle facilement n'importe où, ou se monte à la base du panneau pour une utilisation murale.

Pulsador inalámbrico RGB / RGB wireless push button / Bouton poussoir sans fil RVB

Control / Input Signal / Signal d'entrée	RF (2.4GHz)
Tensión de trabajo / Controls Working voltage / Tension de fonctionnement	3VDC(AAAx2)
Tamaño / Size / Taille	L86 x W86 x H14 mm
Distancia / Distance / Distance	30M
PVP	34,95€

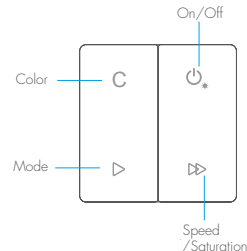

Encendido / apagado: pulse brevemente para encender o apagar la luz, mantenga pulsado 1-6s para ajustar el brillo de forma continua.
Modo: Cambia el modo dinámico. Pulse brevemente el siguiente modo de ejecución, mantenga pulsado 2s run mode-cycle.

CENTRAL WIFI

WIFI CENTER
CENTRE Wi-Fi

Ref.: **88512**



WiFi-Relay



- Puede mezclar y cargar todos los productos de la serie inalámbrica LYOPRO RF 2.4GHz, incluidos los controladores LED, los controladores LED de intensidad regulable, Luces LED, 0-10V y atenuadores Triac.
- Puede controlar la atenuación, la temperatura del color, los efectos de luz RGB, RGBW y RGB + CCT.
- Se puede configurar en 1-16 zonas y 8 memorias de escena.
- Incluye un cable micro USB.
- Próximamente disponible en el software Android y IOS (Nombre de la aplicación: LyoSmart).

- You can mix and charge all products in the LYOPRO RF 2.4GHz wireless series, including LED Drivers, Dimmable LED Drivers, LED Lights, 0-10V and Triac Dimmers.
- You can control dimming, color temperature, RGB, RGBW and RGB + CCT light effects.
- It can be configured in 1-16 zones and 8 scene memories.
- Includes a micro USB cable.
- Soon available on Android and IOS software (App name: LyoSmart).

- Vous pouvez mélanger et charger tous les produits de la série sans fil LYOPRO RF 2,4 GHz, y compris Drivers LED, Drivers LED à intensité variable, Lumières LED, Gradateurs 0-10V et Triac.
- Vous pouvez contrôler la gradation, la température de couleur, les effets lumineux RGB, RGBW et RGB + CCT.
- Il peut être configuré en 1-16 zones et 8 mémoires de scènes.
- Comprend un câble micro USB.
- Bientôt disponible sur les logiciels Android et IOS (Nom de l'application : LyoSmart).

Central Wifi / Wi-Fi hub / Concentrateur Wi-Fi

Control / Input Signal / Signal d'entrée	DC5-24V, 300MA
Estándar inalámbrico / wireless standard / Norme sans fil	802.11 B7g7N
Rango de Frecuencia / Frequency range / Gamme de fréquences	2.412GHz-2.484GHz
Tamaño / Size / Taille	72 x 25 mm
Distancia / Distance / Distance	30M
PVP	82,95€

Indicador LED

Blanco: estado de inicialización de WiFi-Relay.
Amarillo: ejecutando el modo de conexión directa.
Azul: modo de red doméstica en ejecución.
Rojo: restablecer el estado de configuración de fábrica.
Parpadeo: estado de señal de recepción.

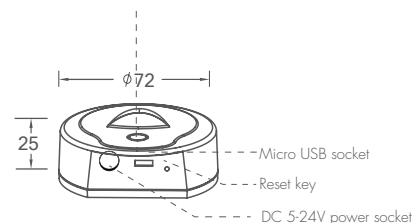

TIRAS Y NEÓN 24V MONOCOLOR

APLICACIÓN / APPLICATION / APPLICATION

RECEPTOR / RECEIVER / DESTINATAIRE

EMISOR / TRANSMITTER / ÉMETTEUR

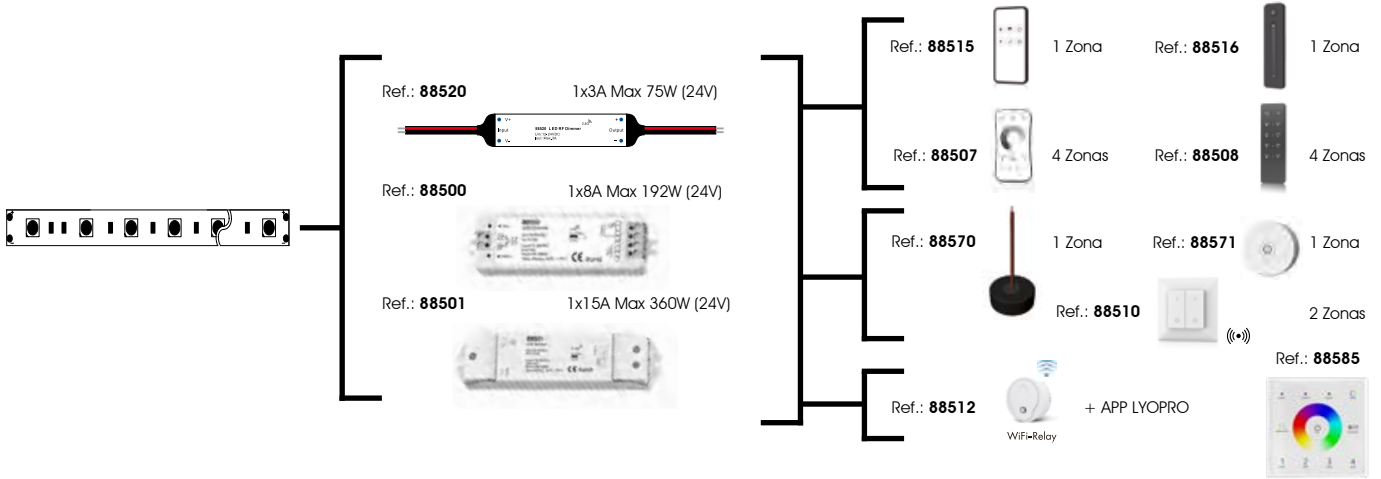

TIRAS Y NEÓN 24V RGB

APLICACIÓN / APPLICATION / APPLICATION

RECEPTOR / RECEIVER / DESTINATAIRE

EMISOR / TRANSMITTER / ÉMETTEUR

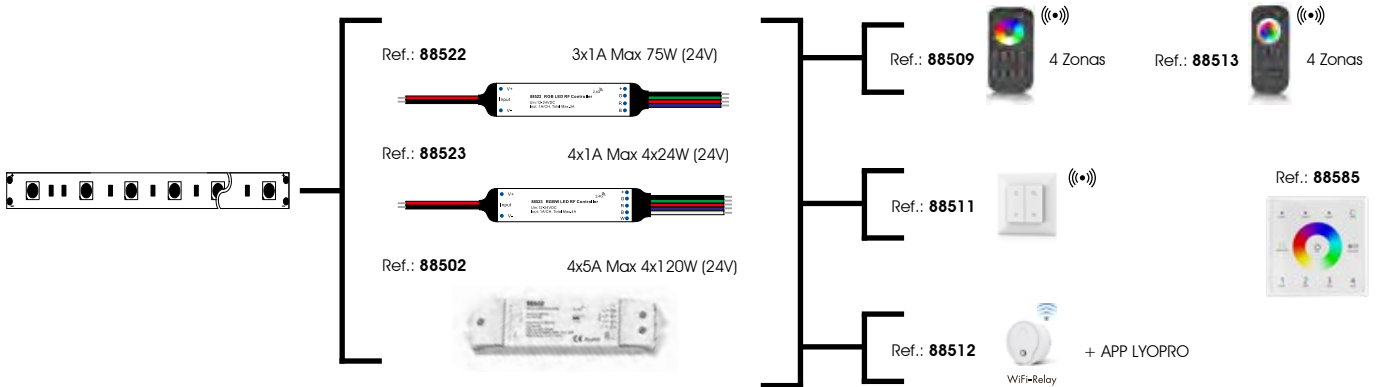

TIRAS 24V RGB+CCT

APLICACIÓN / APPLICATION / APPLICATION

RECEPTOR / RECEIVER / DESTINATAIRE

EMISOR / TRANSMITTER / ÉMETTEUR

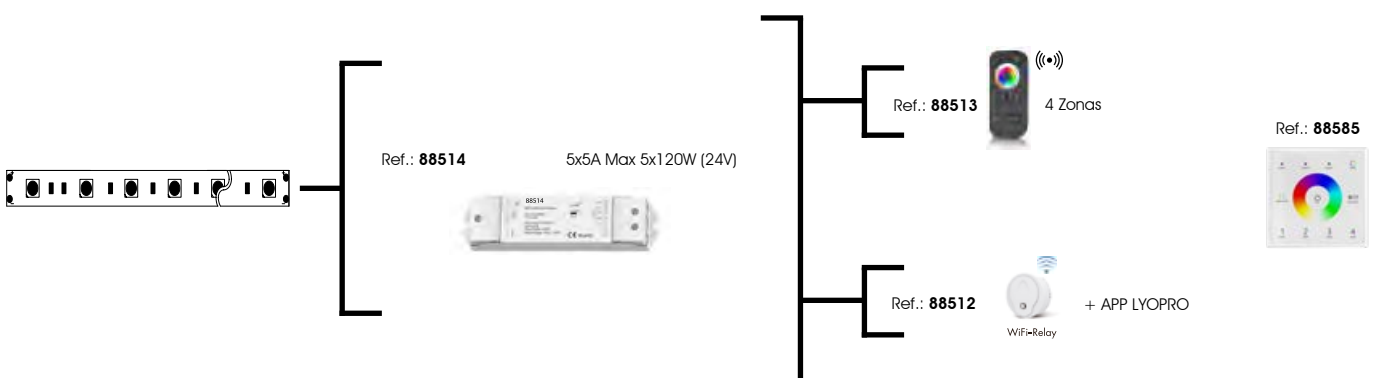

TIRAS 24V CCT (TUNABLE WHITE)

APLICACIÓN / APPLICATION / APPLICATION RECEPTOR / RECEIVER / DESTINATAIRE EMISOR / TRANSMITTER / ÉMETTEUR

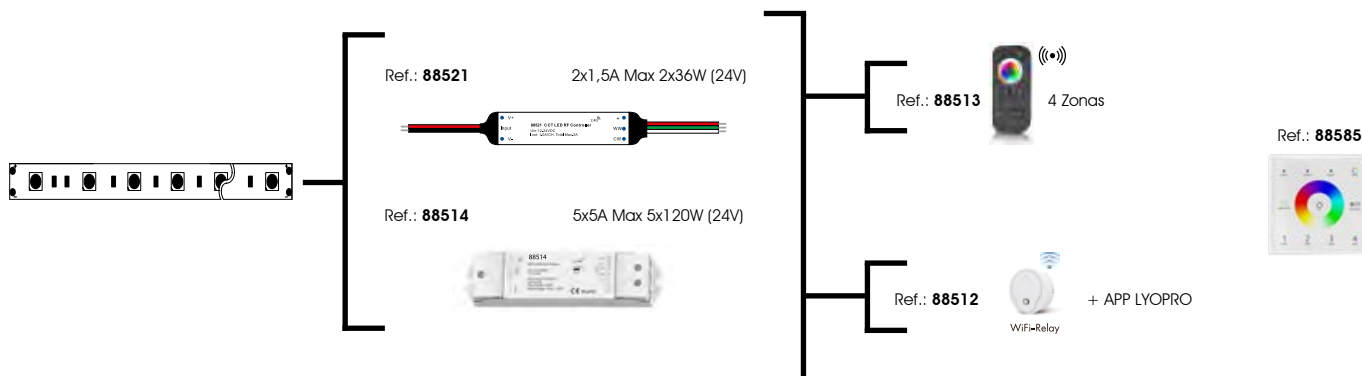

TIRAS Y NEÓN 230V MONOCOLOR

APLICACIÓN / APPLICATION / APPLICATION RECEPTOR / RECEIVER / DESTINATAIRE EMISOR / TRANSMITTER / ÉMETTEUR

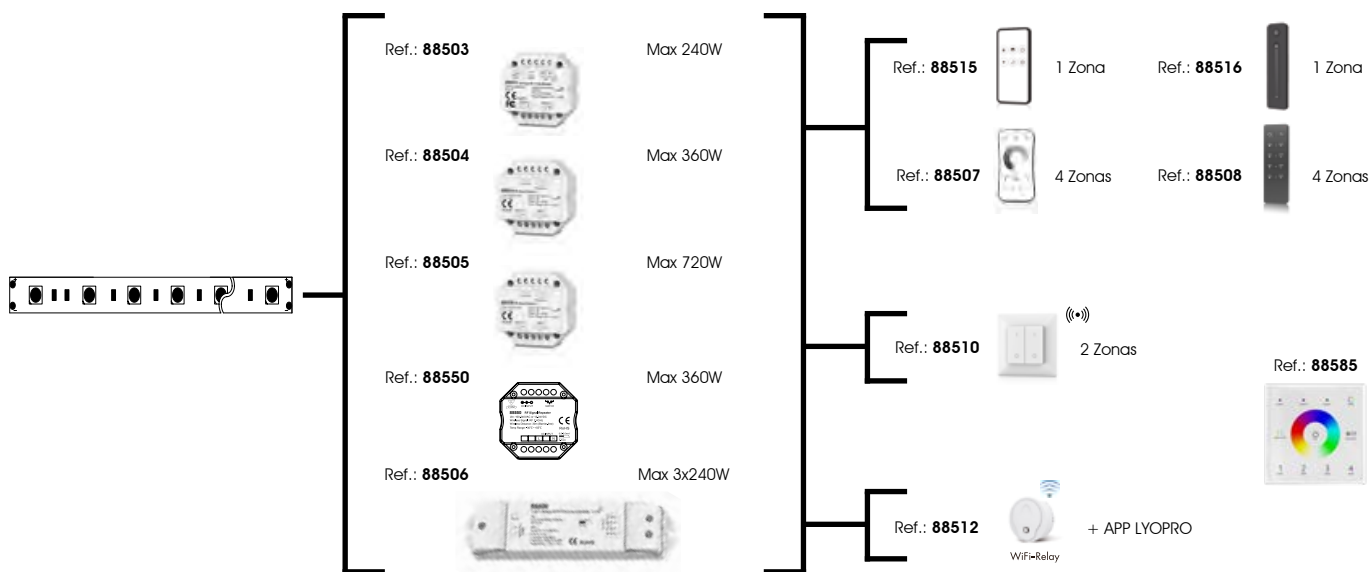

TIRAS 230V RGB

APLICACIÓN / APPLICATION / APPLICATION RECEPTOR / RECEIVER / DESTINATAIRE EMISOR / TRANSMITTER / ÉMETTEUR

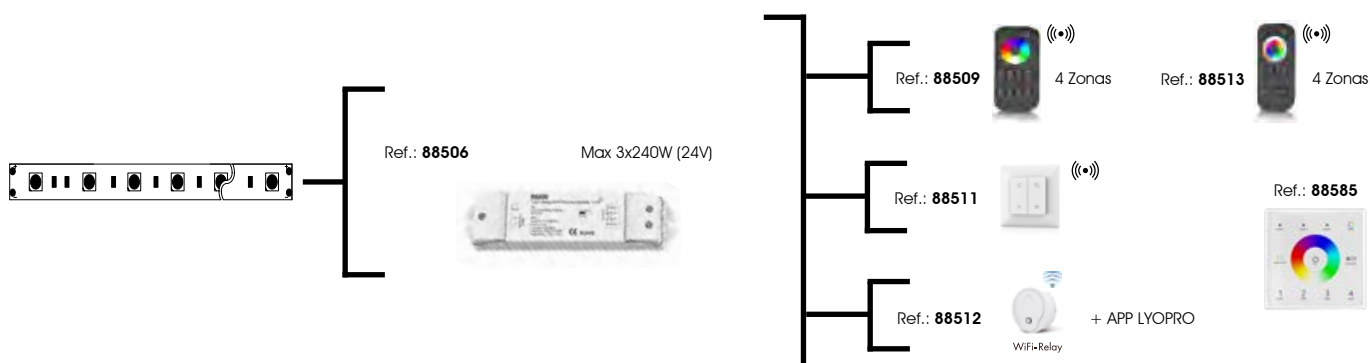

Maletin expositor perfiles / Exhibitor briefcase profiles / Profilés mallettes exposants



Ref.: **90017**
PVP: 119,95€

Expositor tiras Led / Led strip display / Affichage à bande led

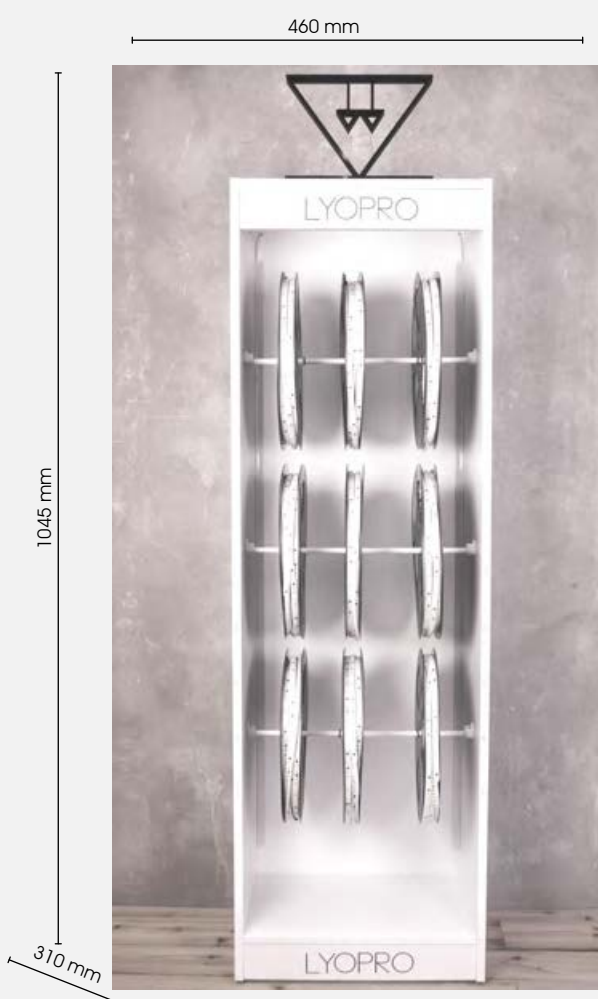

Ref.: **90028**
PVP: 395,95€



Servicio de corte a medida / Cut to size service / Service de coupe sur mesure

Servicio que disponemos para nuestros clientes donde les ofrecemos la posibilidad de realizar la manipulación necesaria ya sean cortes tanto en tiras como en periferia o soldaduras, para conseguir un nivel óptimo de acabado en nuestras tiras según la exigencia de la obra.
Service that we have for our clients where we offer them the possibility of carrying out the necessary manipulation, whether it is cuts in strips, profiles or welds, to achieve an optimal level of finish in our strips according to the requirements of the work.
Service que nous avons pour nos clients où nous leur offrons la possibilité d'effectuer les manipulations nécessaires, qu'il s'agisse de coupes en bandes, de Profilés ou de soudures, pour obtenir un niveau de finition optimal de nos bandes selon les exigences du travail.

Opciones de corte / Exhibitor briefcase profiles / Options de coupe

		PVP
Soldadura monocolor inicio + 20cm. cable / Monocolor soldering start + 20cm. wire / Début de soudage monochrome + 20cm. fil	90020	3,95€
Soldadura monocolor inicio + 50cm. cable / Monocolor soldering start + 50cm. wire / Début de soudage monochrome + 50cm. fil	90021	4,25€
Soldadura monocolor inicio + 1m. cable / Monocolor soldering start + 1m. wire / Début de soudage monochrome + 1m. fil	90022	4,45€
Soldadura monocolor inicio + 2m. cable / Monocolor soldering start + 2m. wire / Début de soudage monochrome + 2m. fil	90029	5,95€
Soldadura monocolor inicio + 3m. cable / Monocolor soldering start + 3m. wire / Début de soudure monochrome + 3m. fil	90030	7,25€
Soldadura monocolor inicio + 4m. cable / Monocolor soldering start + 4m. wire / Début de soudage monochrome + 4m. fil	90031	8,25€
Soldadura monocolor inicio + 5m. cable / Monocolor soldering start + 5m. wire / Début de soudage monochrome + 5m. fil	90032	9,95€
Soldadura empalme monocolor / Single color joint weld / Soudure unicolore	90023	5,25€
Soldadura RGB/RGBW inicio + 20cm. cable / RGB/RGBW soldering start + 20cm. wire / Début de soudage RGB/RGBW + 20cm. fil	90024	5,95€
Soldadura RGB/RGBW inicio + 50cm. cable / RGB/RGBW soldering start + 50cm. wire / Début de soudage RGB/RGBW + 50cm. fil	90025	6,45€
Soldadura RGB/RGBW inicio + 1m. cable / RGB/RGBW soldering start + 1m. wire / Début de soudage RGB/RGBW + 1m. fil	90026	6,95€
Soldadura RGB/RGBW inicio + 2m. cable / RGB/RGBW soldering start + 2m. wire / Début de soudage RGB/RGBW + 2m. fil	90033	8,45€
Soldadura RGB/RGBW inicio + 3m. cable / RGB/RGBW soldering start + 3m. wire / Début de soudage RGB/RGBW + 3m. fil	90034	10,45€
Soldadura RGB/RGBW inicio + 4m. cable / RGB/RGBW soldering start + 4m. wire / Début de soudage RGB/RGBW + 4m. fil	90035	11,95€
Soldadura RGB/RGBW inicio + 5m. cable / RGB/RGBW soldering start + 5m. wire / Début de soudage RGB/RGBW + 5m. fil	90036	12,95€
Soldadura empalme RGB/RGBW / RGB/RGBW solder joint / Joint de soudage RVB/RGBW	90027	9,95€
Corte de perfil aluminio / Aluminum profile cutting / Coupe de profilé en aluminium	90028	2,95€
Sellado IP65 para perfil estanco / IP65 sealing for watertight profile / Étanchéité IP65 pour profilé étanche	90040	15,95€
Montaje perfil TURIN / TURIN profile mounting / Montage du profilé TURIN	90060	29,95€
Montaje perfil ESSEN / ESSEN profile mounting / Montage du profilé ESSEN	90061	32,95€
Montaje perfil suspensión / Suspension profile assembly / Assemblage du profilé de suspension	90062	9,95€
Montaje sensor on/off y sensor puertas / Assembly of on/off sensor and door sensor / Assemblage du capteur marche/arrêt et du capteur de porte	90070	7,95€
Montaje sensor de movimiento / Motion Sensor Mount / Support de capteur de mouvement	90071	9,95€
Montaje perfil + difusor completo / Profile assembly + complete diffuser / Ensemble profilé + diffuseur complet	90072	9,95€

* Otras opciones de corte consultar / * Consult other cutting options / * Consulter les autres options de coupe

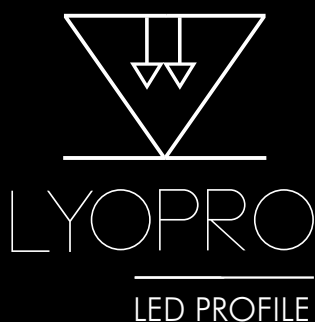

CONDICIONES GENERALES DE VENTA

FORMALIZAR UN PEDIDO IMPLICA LA ACEPTACIÓN DE ESTAS CONDICIONES DE VENTA GENERALES

Todas las ventas se realizan bajo las condiciones relacionadas a continuación. Cualquier especificación que no se ajuste a estas condiciones tendrá que ser antes aceptada por escrito por LYOPRO.

PRESUPUESTOS

Los presupuestos tendrán una validez máxima de 30 días naturales desde la fecha de su emisión.

GARANTÍA Y CALIDAD

Todos nuestros productos están garantizados (consultar en cada caso la ficha técnica en www.lyopro.es) contra cualquier defecto de fabricación. Esta garantía no cubre deterioros sufridos por el uso o aplicación indebida, incorrecta manipulación, una no correcta instalación cuando el producto haya sido usado fuera de su capacidad, maltratado, golpeado, así como cualquier otra falla atribuible al cliente o consumidor o cuando la falla sea original por el desgaste normal de las piezas debido a su funcionamiento o instalación. Queda fuera de la garantía todo material manipulado por personal no autorizado por la empresa. Pequeñas diferencias entre nuestros productos en cuanto a tamaño, color, calidad o cualquier otra modificación en el producto, no serán motivo de reclamación por parte del comprador. Cualquier reclamación imputada en cuanto a cantidad, calidad u otros defectos serán comunicadas a LYOPRO, en un plazo máximo de 48 horas a la recepción de la mercancía, transcurrido este plazo no dará lugar a reclamación alguna. Para la ejecución de la garantía mediante abono o reposición es imprescindible recibir el material en cuestión para poder ser analizado y determinar que ésta procede. Requisito indispensable en toda garantía la presentación de factura y comprobante de pago y rellenando el RMA correspondiente. LYOPRO en continua mejora de la calidad y funcionalidad de sus productos se reserva el derecho a modificar o suprimir cualquiera de estos sin previo aviso sin que ello sea motivo de reclamación por parte del cliente.

PLAZO DE ENTREGA

Los plazos de entrega son sólo aproximados y sin compromiso, no admitiéndose demanda por daños y perjuicios por parte del cliente por demora de la entrega, ni otras demandas o indemnizaciones por incumplimientos contractuales. El incumplimiento del plazo de entrega no faculta al cliente a la rescisión del contrato de compra sin la concesión de un plazo prudencial de tiempo para solucionar dicha demora (importaciones de materiales y productos varios (60-90 días). Las causas de fuerza mayor (guerras, revoluciones, huelgas, catástrofes naturales, roturas de maquinaria, roturas de moldes o matrices, imposibilidad de adquisición de materia prima, interrupción del transporte, cierre de aduanas o cualquier otra medida oficial que pudiera afectar, etc.) nos da el derecho a demorar el plazo de entrega sin previo aviso. Cada operación es una expedición independiente, aunque varias de ellas formen parte de un mismo pedido.

PRECIOS / PORTES

Serán los establecidos en nuestra web a excepción de acuerdos explícitos confirmados por LYOPRO.

PORTES: Condiciones válidas únicamente en territorio peninsular español. Portes pagados a partir de 200€ y en perfiles LED PROFILE de hasta 2 metros de longitud.

Islas Canarias: Portes pagados a partir de 600€ y en perfiles LED PROFILE de hasta 2 metros de longitud. Debido a errores de imprenta, evolución de los productos o a las constantes fluctuaciones de la materia prima, LYOPRO se reserva el derecho de variar los precios sin previo aviso.

Perfiles de más de 2 metros, tendrá un coste adicional de 15 euros por expedición.

PEDIDOS

Todos los pedidos de material cortado ó manipulado deberán confirmarse por escrito (devolviendo la hoja de pedido que se pase por correo electrónico) antes de que entren en funcionamiento. Todo pedido de fabricación y manipulación que supere los 1.500 € el cliente deberá abonar el 50% por adelantado antes del inicio de la fabricación (en concepto de reserva). En todos los pedidos de materiales que no hayan sido cursados por escrito (E-mail) LYOPRO no se hace responsable si hay disconformidad con lo que pidió y se sirvió. Ningún pedido cuya forma de pago sea transferencia entrará en funcionamiento antes de recibir el resguardo del pago.

ANULACIONES-DEVOLUCIONES DE PEDIDOS

No se aceptarán devoluciones transcurridos 15 días desde la entrega de material. Los pedidos pasados en firme no pueden ser anulados sin la conformidad de LYOPRO.

En caso de devolución por causas ajenas a LYOPRO, el material será abonado con un 20% de demérito (con un mínimo de 10 €). No se aceptará ninguna devolución de materiales sin la autorización expresa de LYOPRO y con la hoja de devolución cumplimentada. De igual forma no se aceptará ninguna devolución a portes debidos si el motivo de dicha devolución es error de LYOPRO será LYOPRO quien envíe su agencia). No se aceptará responsabilidad ni reclamación alguna que sobrepase la reposición del material enviado o el pago de éste al precio al que fue adquirido. Ningún producto fabricado a medida ó traído expresamente para el cliente (que no se encuentre en stock habitual) será reembolsado, no teniendo derecho el cliente a reclamación alguna. Cualquier pedido especial, hecho a medida, que lleve cortes etc..., no tendrá devolución

RESERVA DE PROPIEDAD

La mercancía suministrada queda en nuestra total propiedad hasta su pago. El derecho de propiedad subsiste aún después de que el comprador haya revendido el producto, hasta que no haya cancelado la deuda con LYOPRO.

TRANSPORTE

Cualquier anomalía del material recibido o incidencia del transporte deberá ser reflejada en el albarán que se firma al transportista o perderá el derecho a reclamación.

El cliente deberá posteriormente darnos el aviso de la incidencia antes de las 24h posteriores a la entrega, no responsabilizándose en ningún caso si la reclamación es posterior a lo indicado. Es de competencia del cliente ejercer sus acciones con los transportistas en caso de pérdida, avería o retraso de la mercancía. El cliente tiene la obligación de examinar la mercancía en el momento de la entrega y anotar cualquier anomalía. No poner reparo en el talón o albarán de la agencia de transporte se entenderá que es de su conformidad. Si el cliente no ha dado instrucciones especiales de expedición, la mercancía se enviará según nuestro mejor parecer y por medio de transporte elegido por LYOPRO.

PAGO

Las condiciones de pago serán las acordadas con nuestros clientes. Los vencimientos de los pagos mediante cualquier documento de pago legalmente aceptado, deberán de respetarse puntualmente. En caso contrario estamos facultados a cargar los intereses de demora, así como los quebrantos ocasionados por la demora en el pago. Las demoras en el pago traen consigo con efecto inmediato la anulación de todos los compromisos de LYOPRO para con el cliente. El comprador no está autorizado a retener la totalidad a parte de los pagos vencidos por no habersele reconocido alguna reclamación, ya que ésta no le exime de su compromiso de pago. Todo impagado o retraso en el pago anula la posibilidad del crédito, paralizando el suministro de materiales en tanto no se regularice la situación. Si esta situación fuera repetitiva, se procederá a comunicarlo a CRÉDITO & CAUCIÓN cancelándose el crédito de forma irrevocable.

FUERO

Para cuantas cuestiones y discrepancias se deriven de la presente operación, comprador y vendedor se someten expresamente a la competencia de los jueces y tribunales de los Juzgados de Valencia con renuncia a cualquier otro fuero propio o reserva de dominio que pudiera corresponder.

COSTAS Y GASTOS

Los gastos y costas judiciales, incluso honorarios de Abogado y derechos de Procurador, serán siempre por cuenta de la parte contratante que hubiera dado lugar a ellos por incumplimiento de estas condiciones generales de venta o del contrato en general.

DERECHO SUPLETORIO

El presente contrato de venta se regirá por lo aquí convenido y en su defecto por las normas del Código de Comercio Español para las ventas en España.

GENERAL SALE CONDITIONS

FORMALIZING AN ORDER IMPLIES THE ACCEPTANCE OF THESE GENERAL CONDITIONS OF SALE

All sales are made under the conditions listed below. Any specification that does not conform to these conditions will have to be previously accepted in writing by LYOPRO.

OFFERS

Budgets will be valid for a maximum of 30 calendar days from the date of issue.

WARRANTY AND QUALITY

All our products are guaranteed (consult the technical sheet in each case at www.lyopro.es) against any manufacturing defect. This guarantee does not cover deterioration suffered by improper use or application, incorrect handling, incorrect installation when the product has been used beyond its capacity, mistreated, hit, as well as any other failure attributable to the client or consumer or when the failure is due to the normal wear and tear of the parts due to its operation or installation. Any material handled by personnel not authorized by the company is out of warranty. Small differences between our products in terms of size, color, quality or any other modification in the product will not be grounds for a claim by the buyer. Any claim made in terms of quantity, quality or other defects will be communicated to LYOPRO, within a maximum period of 48 hours upon receipt of the merchandise, after this period will not give rise to any claim. For the execution of the guarantee through payment or replacement, it is essential to receive the material in question in order to be able to analyze it and determine that it is appropriate. An essential requirement in any guarantee is the presentation of the invoice and proof of payment and filling in the corresponding RMA. LYOPRO in continuous improvement of the quality and functionality of its products reserves the right to modify or delete any of these without prior notice without this being a reason for a claim by the client.

DELIVERY TERM

Delivery times are only approximate and without obligation, not accepting claims for damages by the customer for delayed delivery, or other claims or compensation for breaches of contract. Failure to comply with the delivery period does not authorize the client to terminate the purchase contract without granting a reasonable period of time to solve said delay (imports of materials and various products (60-90 days). Force majeure (wars, revolutions, strikes, natural catastrophes, machinery breakage, mold or die breakage, impossibility of acquiring raw materials, transport interruption, customs closure or any other official measure that may affect, etc.) gives us the right to delay the delivery period without prior notice. Each operation is an independent expedition, even if several of them are part of the same order.

PRICES / SHIPPING

FREIGHT: The transport price conditions for outside Spain will be defined with the opening of each customer's file.

ORDERS

All orders for cut or manipulated material must be confirmed in writing (returning the order form sent by email) before they go into operation. Any order for manufacturing and handling that exceeds €1,500, the customer must pay 50% in advance before the start of manufacturing (as a reserve). In all requests for materials that have not been made in writing (E-mail) LYOPRO is not responsible if there is disagreement with what was requested and served. No order whose payment method is transfer will start working before receiving the receipt of payment.

CANCELLATIONS-RETURNS OF ORDERS

Returns will not be accepted after 15 days from the delivery of material. Firm orders cannot be canceled without the consent of LYOPRO. In case of return for reasons beyond LYOPRO's control, the material will be paid with a 20% demerit (with a minimum of €10). No return of materials will be accepted without the express authorization of LYOPRO and with the completed return sheet. In the same way, no return to postage due will be accepted if the reason for said return is a LYOPRO error, LYOPRO will be the one who sends its agency). No liability or claim will be accepted that exceeds the replacement of the material sent or the payment thereof at the price at which it was purchased. No product made to measure or brought expressly for the client (that is not in regular stock) will be reimbursed, and the client is not entitled to any claim. Any special order, made to measure, that has cuts, etc..., will not be refundable.

PROPERTY RESERVATION

The supplied goods remain our full property until paid for. The property right subsists even after the buyer has resold the product, until the debt with LYOPRO has been cancelled.

TRANSPORT

Any anomaly of the material received or incidence of transport must be reflected in the delivery note that is signed to the carrier or you will lose the right to claim. The client must subsequently notify us of the incident within 24 hours after delivery, not being responsible in any case if the claim is made after to the indicated. It is the responsibility of the client to exercise their actions with the carriers in case of loss, breakdown or delay of the merchandise. The client has the obligation to examine the merchandise at the time of delivery and note any anomalies. Not objecting to the check or delivery note of the transport agency will be understood to be in accordance with it. If the client has not given special shipping instructions, the merchandise will be sent according to our best opinion and by means of transport chosen by LYOPRO.

PAYMENT TERMS

The payment terms will be those agreed with our clients. Payment due dates through any legally accepted payment document must be respected promptly. Otherwise, we are entitled to charge late-payment interest, as well as losses caused by late payment. Delays in payment bring with immediate effect the cancellation of all LYOPRO commitments to the client. The buyer is not authorized to withhold all or part of the overdue payments for not having recognized any claim, since this does not exempt him from his commitment to pay. Any non-payment or delay in payment annuls the possibility of credit, paralyzing the supply of materials until the situation is regularized. If this situation is repetitive, it will proceed to notify CREDIT & SURETY, canceling the credit irrevocably.

JURISDICTION

For any questions and discrepancies arising from this operation, buyer and seller expressly submit to the jurisdiction of the judges and courts of the Courts of Valencia, waiving any other jurisdiction or reservation of ownership that may correspond.

COSTS AND EXPENSES

Legal expenses and costs, including attorney's fees and Attorney's rights, will always be borne by the contracting party that would have given rise to them due to breach of these general conditions of sale or of the contract in general.

SUPPLEMENTARY RIGHT

This sales contract will be governed by what is agreed herein and, failing that, by the rules of the Spanish Commercial Code for sales in Spain.

CONDITIONS GENERALES DE VENTE

LA FORMALISATION D'UNE COMMANDE IMPLIQUE L'ACCEPTATION DES PRESENTES CONDITIONS GENERALES DE VENTE

Toutes les ventes sont faites dans les conditions énumérées ci-dessous. Toute spécification non conforme à ces conditions devra être préalablement acceptée par écrit par LYOPRO.

DEVIS

Les budgets seront valables pendant un maximum de 30 jours calendaires à compter de la date d'émission.

GARANTIE ET QUALITÉ

Tous nos produits sont garantis (consultez la fiche technique dans chaque cas sur www.lyopro.es) contre tout défaut de fabrication. Cette garantie ne couvre pas les détériorations subies par une mauvaise utilisation ou application, une mauvaise manipulation, une mauvaise installation lorsque le produit a été utilisé au-delà de ses capacités, maltraité, heurté, ainsi que toute autre défaillance imputable au client ou au consommateur ou lorsque la défaillance est due à l'usure normale des pièces due à son fonctionnement ou à son installation. Tout matériel manipulé par du personnel non autorisé par l'entreprise est hors garantie. Les petites différences entre nos produits en termes de taille, de couleur, de qualité ou toute autre modification du produit ne pourront donner lieu à réclamation de la part de l'acheteur. Toute réclamation formulée en termes de quantité, qualité ou autres défauts sera communiquée à LYOPRO, dans un délai maximum de 48 heures à réception de la marchandise, passé ce délai ne pourra donner lieu à aucune réclamation. Pour l'exécution de la garantie par paiement ou remplacement, il est indispensable de recevoir le matériel en question afin de pouvoir l'analyser et déterminer s'il est approprié. Une exigence essentielle de toute garantie est la présentation de la facture et de la preuve de paiement et le remplissage du RMA correspondant. LYOPRO dans l'amélioration continue de la qualité et de la fonctionnalité de ses produits se réserve le droit de modifier ou de supprimer l'un quelconque de ceux-ci sans préavis sans que cela puisse constituer un motif de réclamation de la part du client.

DÉLAI DE LIVRAISON

Les délais de livraison ne sont qu'approximatifs et sans engagement, n'acceptant pas les demandes de dommages-intérêts du client pour retard de livraison, ou d'autres réclamations ou compensations pour rupture de contrat. Le non-respect du délai de livraison n'autorise pas le client à résilier le contrat d'achat sans accorder un délai raisonnable pour résoudre ledit retard (importations de matériels et produits divers (60-90 jours). Force majeure (guerres, révolutions, grèves, catastrophes naturelles, bris de machines, bris de moule ou de matrice, impossibilité d'acquérir des matières premières, interruption de transport, fermeture douanière ou toute autre mesure officielle pouvant affecter, etc.) nous donne le droit de retarder le délai de livraison sans préavis. Chaque opération est une expédition indépendante, même si plusieurs d'entre elles font partie du même ordre.

PRIX / LIVRAISON

FRET: Les conditions du prix du transport pour l'extérieur de l'Espagne seront définies à l'ouverture du dossier de chaque client.

ORDRES

Toute commande de matériel découpé ou manipulé doit être confirmée par écrit (renvoi du bon de commande envoyé par mail) avant sa mise en service. Toute commande de fabrication et de manutention supérieure à 1 500 €, le client doit régler 50 % d'avance avant le début de la fabrication (à titre de réserve). Dans toutes les demandes de matériel qui n'ont pas été faites par écrit (E-mail), LYOPRO n'est pas responsable en cas de désaccord avec ce qui a été demandé et servi. Aucune commande dont le mode de paiement est le virement ne commencera à fonctionner avant la réception du paiement.

ANNULATIONS-RETOURS DE COMMANDES

Les retours ne seront pas acceptés après 15 jours à compter de la livraison du matériel. Les commandes fermes ne peuvent être annulées sans l'accord de LYOPRO. En cas de retour pour des raisons indépendantes de la volonté de LYOPRO, le matériel sera payé avec un démerite de 20% (avec un minimum de 10€). Aucun retour de matériel ne sera accepté sans l'autorisation expresse de LYOPRO et avec le bordereau de retour complété. De même, aucun retour en port dû ne sera accepté si le motif dudit retour est une erreur LYOPRO, LYOPRO sera celui qui envoie son agence). Aucune responsabilité ou réclamation ne sera acceptée au-delà du remplacement du matériel envoyé ou de son paiement au prix auquel il a été acheté. Aucun produit fabriqué sur mesure ou apporté exprès pour le client (qui n'est pas en stock régulier) ne sera remboursé, et le client ne pourra prétendre à aucune réclamation. Toute commande spéciale, sur mesure, comportant des découpes, etc..., ne sera pas remboursable.

RÉSERVATION DE PROPRIÉTÉ

Les marchandises livrées restent notre entière propriété jusqu'au paiement. Le droit de propriété subsiste même après que l'acheteur a revendu le produit, jusqu'à ce que la dette envers LYOPRO ait été annulée.

TRANSPORT

Toute anomalie du matériel reçu ou incidence du transport doit être mentionnée sur le bon de livraison qui est signé au transporteur ou vous perdrez le droit de réclamer. Le client doit ensuite nous signaler l'incident dans les 24 heures suivant la livraison, n'étant en aucun cas responsable si la réclamation est faite après à l'indiqué Il appartient au client d'exercer ses recours auprès des transporteurs en cas de perte, panne ou retard de la marchandise. Le client a l'obligation d'examiner la marchandise au moment de la livraison et de relever toute anomalie. Ne pas contester le chèque ou le bon de livraison de l'agence de transport sera considéré comme conforme à celui-ci. Si le client n'a pas donné d'instructions d'expédition particulières, la marchandise sera expédiée selon notre meilleur avis et par le moyen de transport choisi par LYOPRO.

CONDITIONS DE PAIEMENT

Les conditions de paiement seront celles convenues avec nos clients. Les dates d'échéance de paiement via tout document de paiement légalement accepté doivent être respectées rapidement. Dans le cas contraire, nous sommes en droit de facturer des intérêts de retard, ainsi que les pertes causées par un retard de paiement. Les retards de paiement entraînent avec effet immédiat l'annulation de tous les engagements de LYOPRO envers le client. L'acheteur n'est pas autorisé à retenir tout ou partie des retards de paiement pour n'avoir reconnu aucune créance, dès lors que cela ne le dispense pas de son engagement de payer. Tout non-paiement ou retard de paiement annule la possibilité de crédit, paralysant l'approvisionnement en matériaux jusqu'à ce que la situation soit régularisée. Si cette situation est répétitive, il procédera à la notification de CREDIT & SURETY, annulant irrévocablement le crédit.

JURIDICTION

Pour toutes questions et divergences découlant de cette opération, l'acheteur et le vendeur se soumettent expressément à la compétence des juges et des tribunaux des tribunaux de Valence, renonçant à toute autre juridiction ou réserve de propriété qui pourrait correspondre.

COÛTS ET DÉPENSES

Les frais et dépenses judiciaires, y compris les honoraires et droits d'avocat, seront toujours à la charge du cocontractant qui les a engendrés du fait de la violation des présentes conditions générales de vente ou du contrat en général.

DROIT SUPPLÉMENTAIRE

Ce contrat de vente sera régi par ce qui est convenu ici et, à défaut, par les règles du Code de commerce espagnol pour les ventes en Espagne.

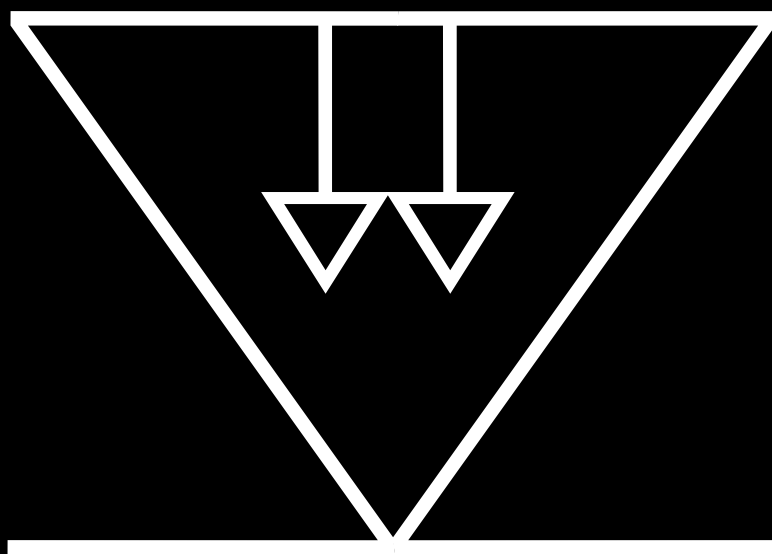

Lighting with you

Síguenos en:

Follow us:

Suivez nous:



Lighting Products S.L.

C/. 32, 130 Pol. Ind. El Bony
46470 CATARROJA (VALENCIA)

Telf. 96 118 11 38

Mail: info@lightingproducts.es

www.lyopro.es