

LYOPRO

LEVEL

2024
NEW PRODUCT
CATALOGUE

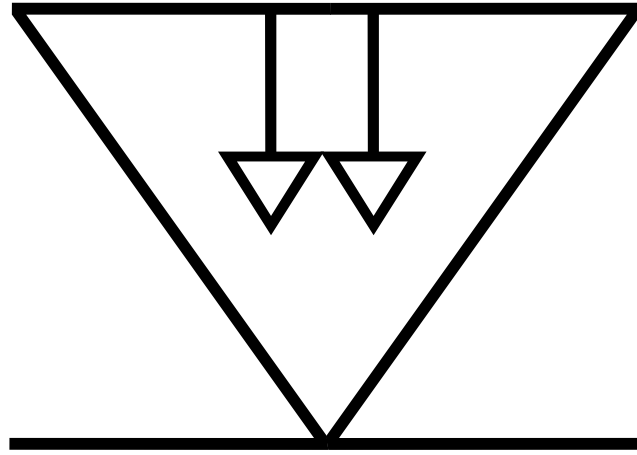

LYOPRO

LEVEL

Lighting with you

LYOPRO es una empresa joven y dinámica que da mucha importancia a la **luz** tanto en interiores como en exteriores.

Realizamos proyectos de iluminación mediante un completo estudio lumínico tras conversación con el equipo de trabajo (**distribución sobre plano, fotomontajes, cálculos lumínicos, renderizados y 3D**), ajustándonos a las necesidades tanto económicas como estéticas, aportando ideas innovadoras y creativas para conseguir que la luz forme parte de la decoración.

Minucioso **seguimiento a pie de obra**, estableciendo reuniones con los profesionales para garantizar los resultados.

*LYOPRO is a young and dynamic company that attaches great importance to **light** both indoors and outdoors.*

*We carry out lighting projects through a complete lighting study after conversation with the work team (**plan distribution, photomontages, lighting calculations, renderings and 3D**), adjusting to both economic and aesthetic needs, providing innovative and creative ideas to ensure that light become part of the decor.*

*Detailed **follow-up on site**, establishing meetings with professionals to guarantee results.*

LYOPRO est une entreprise jeune et dynamique qui attache une grande importance à la **lumière** aussi bien en intérieur qu'en extérieur.

Nous réalisons des projets d'éclairage à travers une étude d'éclairage complète après conversation avec l'équipe de travail (**distribution des plans, photomontages, calculs d'éclairage, rendus et 3D**), en nous adaptant aux besoins économiques et esthétiques, en apportant des idées innovantes et créatives pour que la lumière fasse partie de le décor.

Suivi **détaillé sur place**, mise en place de rencontres avec des professionnels pour garantir les résultats.



CATÁLOGO LEVEL

LYOPRO vamos más allá en su progresión y desarrollamos un catálogo donde queremos hacer patente la consolidación de nuestra marca en un sector especializado como es el mundo del **CONTRACT**, la arquitectura e ingeniería. Para ello plasmamos en nuestro catálogo **LEVEL**, todas aquellas necesidades que los profesionales se encuentran para poder seleccionar luminarias acordes a los requerimientos que se solicitan en una obra, ya sea a nivel estético, económico, rendimientos, garantías, etc, además de dar a nuestros clientes la posibilidad de confeccionar sus propias luminarias, eligiendo colores, ópticas, formas, etc, en un gran número de los artículos presentados. Con **LEVEL** podemos alcanzar cualquier objetivo lumínico que se nos brinde.

Para ello **LYOPRO LEVEL** cuenta en su contenido con un gran número de luminarias con un elevado confort visual, rendimiento y prestaciones.

*LYOPRO goes further in its progression and we develop a catalog where we want to make clear the consolidation of our brand in a specialized sector such as the world of **CONTRACT**, architecture and engineering. For this, we capture in our **LEVEL** catalog, all those needs that professionals find to be able to select luminaires according to the requirements that are requested in a work, be it aesthetically, economically, yields, guarantees, etc., in addition to giving our customers the possibility of making their own luminaires, choosing colors, optics, shapes, etc., in a large number of the articles presented. With **LEVEL** we can achieve any lighting objective that is given to us.*

*For this, **LYOPRO LEVEL** has in its content a large number of luminaires with high visual comfort, performance and benefits.*

LYOPRO va plus loin dans sa progression et nous développons un catalogue où nous voulons souligner la consolidation de notre marque dans un secteur spécialisé tel que le monde du **CONTRAT**, de l'architecture et de l'ingénierie. Pour cela, nous capturons dans notre catalogue **LEVEL**, tous les besoins que les professionnels trouvent pour pouvoir sélectionner les luminaires en fonction des exigences demandées dans un travail, que ce soit esthétiquement, économiquement, rendements, garanties, etc., en plus de donner à nos clients la possibilité de réaliser leurs propres luminaires, en choisissant les couleurs, les optiques, les formes, etc., dans un grand nombre d'articles présentés. Avec **LEVEL**, nous pouvons atteindre n'importe quel objectif d'éclairage qui nous est donné.

Pour cela, **LYOPRO LEVEL** dispose dans son contenu d'un grand nombre de luminaires à haut confort visuel, performances et prestations.

SHOWROOM

Lyopro Showroom es una nueva forma de enseñar nuestras luminarias al mundo. Un espacio creado para que nuestros clientes puedan ver en directo el impacto lumínico de las luminarias y su componente estético, diseño, material y calidad de todos y cada uno de los productos que conforman los distintos portfolios de nuestra marca. Un lugar construido a través de diferentes estancias para poder comprobar todo aquello que necesitas para seleccionar aquello que más le conviene a tu proyecto. Este proyecto de Showroom en Valencia nace de la necesidad de que nuestros clientes puedan conocer las luminarias que les recomendamos en cada uno de sus proyectos, es un espacio de creación en común con nuestros clientes. En nuestro Lyopro Showroom, podrás pasear por diferentes estancias en las que ver en funcionamiento nuestras luminarias más características de nuestros catálogos: LYOPRO LED PROFILE, LYOPRO LEVEL.

Disponemos de una red de Técnicos Comerciales expertos en el asesoramiento con nuestros clientes.

Lyopro Showroom is a new way of exhibiting and displaying our lighting solutions to the public. We created this space so that our clients can have a closer look at all the details of the lighting products from the different collections, such as their aesthetic, design, materials and quality. A place built through different stays to be able to check everything you need to select what you most suits your project. We conceptualised the Valencia showroom with the needs of our clients in mind because we wanted to be able to showcase our products. At the Lyopro Showroom, you can walk through different rooms where you can see our most well known products from our catalogues: LYOPRO LED PROFILE, LYOPRO LEVEL.

There is also always a commercial technician, who can assist you with their expertise.

Lyopro Showroom est une nouvelle façon de montrer nos luminaires au monde entier. Un espace créé pour que nos clients puissent voir en direct l'impact lumineux des luminaires et leur composante esthétique, leur design, leurs matériaux et la qualité de chacun des produits qui composent les différents portefeuilles de notre marque. Un endroit construit à travers différentes pièces pour vérifier tout ce dont vous avez besoin pour sélectionner ce qui convient à votre projet. Ce projet de showroom à Valence est né du besoin pour nos clients de connaître les luminaires que nous recommandons dans chacun de leurs projets, c'est un espace de création en commun avec nos clients. Dans notre Lyopro Showroom, vous pouvez vous promener dans différentes salles où vous pouvez voir en fonctionnement nos luminaires les plus caractéristiques de nos catalogues: LYOPRO LED PROFILE, LYOPRO LEVEL.

Nous disposons d'un réseau de techniciens commerciaux experts pour conseiller nos clients



SIMBOLOGÍA / SYMBOLS / SYMBOLES

	Led Chip Edison <i>Led chip Edison</i> Puce led Edison		Grado de impermeabilidad y resistencia al polvo <i>Degree of impermeability and resistance to dust</i> Degré d'imperméabilité et de résistance à la poussière		Instalación interior <i>Indoor installation</i> Installation intérieure
	Led Chip Bridgelux <i>Led Chip Bridgelux</i> Puce led Bridgelux		Certificación diseñada para asegurar que el equipo pueda resistir los lavados a alta presión y con vapor <i>Certification designed to ensure equipment can withstand high pressure and steam wash downs</i> Certification conçue pour garantir que l'équipement peut résister aux hautes pressions et aux lavages à la vapeur		Instalación exterior <i>Outdoor installation</i> Installation extérieure
	Led Chip Cree <i>Led chip Cree</i> Puce led Cree		Resistencia mecánica a los golpes <i>Résistance mécanique aux chocs</i> Mechanical resistance to shock		Instalación en pared <i>Wall installation</i> Montage mural
	Led Chip Epistar <i>Led chip Epistar</i> Puce led Epistar		Temperatura de trabajo <i>Work temperature</i> Température de travail		Instalación en suelo <i>Ground installation</i> Mise en place au sol
	Led Chip Ever Light <i>Led chip Ever Light</i> Puce led Ever Light		Equipo incluido <i>Equipment included</i> Équipement inclus		Instalación en techo <i>Ceiling installation</i> Installation au plafond
	Led Chip Lumileds <i>Led chip Lumileds</i> Puce led Lumileds		Equipo no incluido <i>Equipment not included</i> Équipement non inclus		Instalación en pared o suelo <i>Wall or floor installation</i> Pose au mur ou au sol
	Led Chip Sanan <i>Led chip Sanan</i> Puce led Sanan		Clase I - clase de aislamiento eléctrico (IEC) <i>Equipment in Class I - electrical insulation class (IEC)</i> Équipement en classe I - classe d'isolation électrique (CEI)		Instalación en techo o pared <i>Ceiling or wall installation</i> Installation au plafond ou au mur
	Led Chip Seoul <i>Led chip Seoul</i> Puce led Seoul		Clase II - clase de aislamiento eléctrico (IEC) <i>Class II - electrical insulation class (IEC)</i> Classe II - classe d'isolation électrique (CEI)		Instalación en techo, pared o suelo <i>Installation on ceiling, wall or floor</i> Installation au plafond, au mur ou au sol
	Led Chip Samsung <i>Led chip Samsung</i> Puce led Samsung		Clase III - clase de aislamiento eléctrico (IEC) <i>Class III - electrical insulation class (IEC)</i> Classe III - classe d'isolation électrique (CEI)		Dispositivo para tránsito de vehículos <i>Vehicle transit device</i> Dispositif de transit de véhicule
	Led Chip Special R • G • O <i>Led chip Special R • G • O</i> Puce led Special R • G • O		Pisable por paso humano <i>Walkable by human step</i> Praticable à pas humain		Instalación colgante <i>Hanging installation</i> Pose suspendue
	Led Chip Luminus <i>Led chip Luminus</i> Puce led Luminus		Haz de luz orientable <i>Adjustable light beam</i> Faisceau lumineux réglable		Color <i>Color</i> Couleur
	Led Chip Tridonic <i>Led chip Tridonic</i> Puce led Tridonic		Haz de luz basculante <i>Tilting light beam</i> Faisceau lumineux inclinable		Blanco <i>White</i> Blanc
	Led Driver Tridonic <i>Led Driver Tridonic</i> Pilote Led Tridonic		Caja de empotrar incluida <i>Embedding box included</i> Boîte d'encastrement incluse		Negro <i>Black</i> Noir
	Led Driver Sosen <i>Led Driver Sosen</i> Pilote Led Sosen		Instalación sin marco <i>Frameless Installation</i> Installation sans cadre		Oro <i>Gold</i> Or
	Led Driver Mean Well <i>Led Driver Mean Well</i> Pilote Led Mean Well		Possibilidad de pintado <i>Possibility of painting</i> Possibilité de peinture		Antracita <i>Anthracite</i> Anthracite
	Led Driver Edison <i>Led Driver Edison</i> Pilote Led Edison		Agujero de instalación cuadrado <i>Square installation hole</i> Trou d'installation carré		Gris <i>Grey</i> Gris
	Led Driver Hep <i>Led Driver Hep</i> Pilote Led Hep		Agujero de instalación redondo <i>Round installation hole</i> Trou d'installation rond		Plata <i>Silver</i> Argent
	Led Driver Osram <i>Led Driver Osram</i> Pilote Led Osram		Conformidad con los estándares de la UE <i>Compliance with EU standards</i> Conformité aux normes de l'UE		Gris Texturizado <i>Textured Grey</i> Gris texturé
	Led Driver Eaglerise <i>Led Driver Eaglerise</i> Pilote Led Eaglerise		Años de garantía <i>Years warranty</i> ans de garantie		Blanco/Rojo <i>White Red</i> Blanc rouge
	Led Driver Lifud <i>Led Driver Lifud</i> Pilote Led Lifud		Años de garantía <i>Years warranty</i> ans de garantie		Blanco/Oro <i>White/Gold</i> Or blanc
	Led Driver Boke <i>Led Driver Boke</i> Pilote Led Boke		Atmósfera explosiva <i>Explosive atmosphere</i> Atmosphère explosive		Blanco/Negro <i>Black White</i> Noir blanc
	Led Driver Inventronics <i>Led Driver Inventronics</i> Pilote Led Inventronics		Cable de alimentación incluido <i>Power cord included</i> Cordon d'alimentation inclus		Plata Mate <i>Matt silver</i> Argent mat
	Smart Control <i>Smart Control</i> Contrôle intelligent		Sumergible <i>Submersible</i> Submersible		Plata Brillo <i>Shiny Silver</i> Argent brillant
	Voltaje <i>Voltage</i> Tensión		Solar <i>Solar</i> Solaire		Piedra <i>Stone</i> Pierre
	Disponible en versión emergencia <i>Available in emergency version</i> Disponible en version d'urgence		Batería / <i>Battery</i> / Batterie		Blanco/Plata Mate <i>White/Matt Silver</i> Blanc/Argent Mat
	Protector sobretensiones <i>Surge protector</i> Parasurtenseur		Tensión 12V VDC / <i>Voltage 12V VDC</i> / Tension 12V cc		Blanco/Plata Brillo <i>White/Gloss Silver</i> Blanc/Argent Brillant
	Cociente de deslumbramiento <i>Glare quotient</i> Quotient d'éblouissement		Tensión 24V VDC / <i>Voltage 24V VDC</i> / Tension 24V cc		Inoxidable <i>Stainless</i> Inoxydable
			Reproducción cromática <i>Color rendering</i> Rendu des couleurs		Acero cepillado <i>Brushed steel</i> Acier brossé
					Bajo Proyecto <i>Under project</i> En projet

COMO INTERPRETAR NUESTRO CATÁLOGO/HOW TO INTERPRET OUR CATALOG/ COMMENT INTERPRÉTER NOTRE CATALOGUE

- | | | | |
|-----|--|-----|---|
| 0. | Nombre del artículo/ <i>Article name</i> /Nom d'article | 14. | Certificado "CE" / "CE" certificate / Certificat "CE" |
| 1. | Fabricante del Chip/ <i>Chip Manufacturer</i> / Fabricant de puces | 15. | Años de Garantía/ <i>Years warranty</i> / Ans de garantie |
| 2. | Fabricante del Driver/ <i>Driver Manufacturer</i> / Fabricant du pilote | 16. | Medida exterior luminaria/ <i>External measurement of luminaire</i> / Mesure externe du luminaire |
| 3. | Grado de Estanqueidad/ <i>Tightness Degree</i> / Degré d'étanchéité | 17. | Medida de corte luminaria/ <i>Luminaire cutting measure</i> / Mesure de coupe du luminaire |
| 4. | Índice de deslumbramiento/ <i>Glare index</i> / Indice d'éblouissement | 18. | Código/ <i>Code</i> / Code |
| 5. | Protector sobretensiones/ <i>Surge protector</i> / parasurtenseur | 19. | Wattios de luminaria/ <i>Luminaire Watts</i> / Puissance des luminaires |
| 6. | Clase de protección/ <i>Protection class</i> / Classe de protection | 20. | Lumen de luminaria/ <i>Luminaire lumen</i> / Lumière du luminaire |
| 7. | Voltaje/ <i>Voltage</i> / Tension | 21. | Grados Kelvin de luminaria/ <i>Kelvin degrees of luminaire</i> / Degrés Kelvin du luminaire |
| 8. | Material/ <i>Material</i> / Matériel | 22. | Versión de luminaria/ <i>Luminaire version</i> / Version luminaire |
| 9. | Posibilidad de luminaria con kit de emergencia/ <i>Possibility of luminaire with emergency kit</i> / Possibilité de luminaire avec kit d'urgence | 23. | Ángulo de apertura/ <i>Opening angle</i> / Angle d'ouverture |
| 10. | Reproducción cromática/ <i>Color rendering</i> / Rendu des couleurs | 24. | Color luminaria/ <i>Luminaire color</i> / Couleur luminaire |
| 11. | Equipo incluido/ <i>Equipment included</i> / Équipement inclus | 25. | Tipo de regulación/ <i>Regulation type</i> / Type de régulation |
| 12. | Área de aplicación INTERIOR - EXTERIOR/ <i>INDOOR - OUTDOOR application area</i> / Domaine d'application INTÉRIEUR - EXTÉRIEUR | 26. | Smart control/ <i>Smart control</i> / Contrôle intelligent |
| 13. | Tipo de instalación a TECHO/ <i>CEILING installation type</i> / Type d'installation au PLAFOND | | |

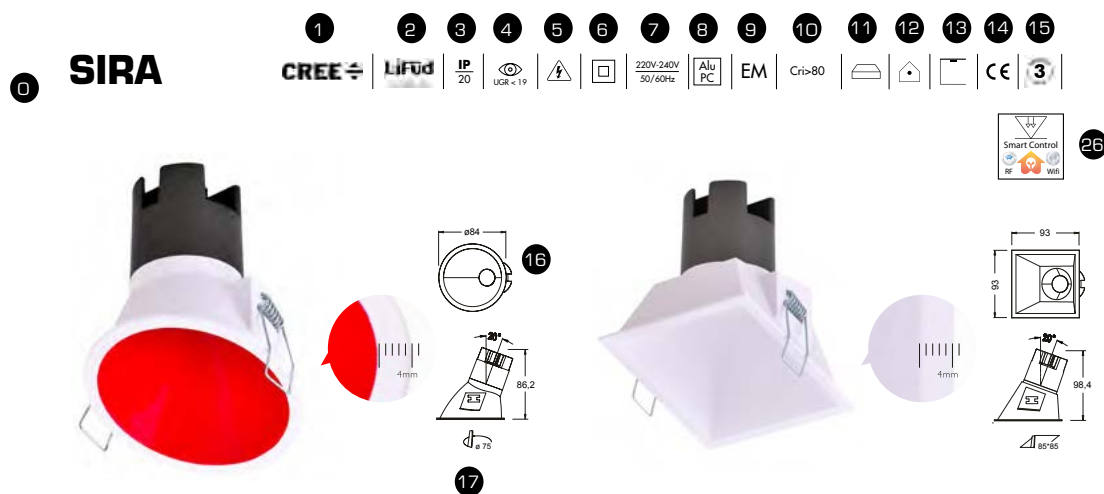

CÓDIGO	W	LM	K	VERSIÓN	ÓPTICA°	ELECTRÓNICA
60300	5w	475Lm	3000K	<u>RA</u> Redondo Asimétrica	<u>15</u>	<u>B</u> <input type="checkbox"/> <u>SR</u> ON/OFF
60301	5w	500Lm	4000K	<u>CA</u> Cuadrado Asimétrica	<u>24</u>	<u>N</u> <input type="checkbox"/> <u>A</u> PUSH
					<u>38</u>	<u>BR</u> <input type="checkbox"/> <u>B</u> 1-10V
						<u>BO</u> <input type="checkbox"/> <u>C</u> DALI
						<u>BPM</u> <input type="checkbox"/> <u>25</u>
						<u>BN</u> <input type="checkbox"/>

COMO COMPLETAR EL CÓDIGO PARA UNA SOLICITUD HOW TO COMPLETE THE CODE FOR AN APPLICATION COMMENT REMPLIR LE CODE POUR UNE DEMANDE

CÓDIGO	W	LM	K	VERSIÓN	ÓPTICA°	ELECTRÓNICA
60300	5w	475Lm	3000K	<u>RA</u> Redondo Asimétrica	<u>15</u>	<u>B</u> <input type="checkbox"/> <u>SR</u> ON/OFF
60301	5w	500Lm	4000K	<u>CA</u> Cuadrado Asimétrica	<u>24</u>	<u>N</u> <input type="checkbox"/> <u>A</u> PUSH
					<u>38</u>	<u>BR</u> <input type="checkbox"/> <u>B</u> 1-10V
						<u>BO</u> <input type="checkbox"/> <u>C</u> DALI
						<u>BPM</u> <input type="checkbox"/> <u>25</u>
						<u>BN</u> <input type="checkbox"/>

CÓDIGO FINAL **60300** **RA** **15** **B** **SR**

Seleccionar todas aquellas posibilidades que están resaltadas en color AZUL en el orden de izquierda a derecha

Select all those possibilities that are highlighted in BLUE color in the order from left to right

Sélectionnez toutes les possibilités qui sont surlignées en BLUE dans l'ordre de gauche à droite

60300RA15BSR Downlight Sira Emp. Red. Asim. 5w 3000K 15 BLANCO SR

CÓDIGO + VERSIÓN + ÓPTICA + COLOR + ELECTRÓNICA

CODE + VERSION + OPTICS + COLOR + ELECTRONICS

CODE + VERSION + OPTIQUE + COULEUR + ÉLECTRONIQUE

ÍNDICE / INDEX / INDICE

MINI DOWNLIGHTS DE EMPOTRAR / RECESSED MINI DOWNLIGHTS / MINI DOWNLIGHTS ENCASTRÉS



AGATE Pag. 11



ELIAN Pag. 11



ARASH Pag. 12



LISA Pag. 13

DOWNLIGHTS DE EMPOTRAR / RECESSED DOWNLIGHTS / DOWNLIGHTS ENCASTRÉS



CORAL AROS GU-10 Pag. 15

New



SIRA Pag. 18-19



New



LUNA Pag. 21



ATLAS Pag. 22

New



AKANE Pag. 23



MOON Pag. 24

New

MINI DOWNLIGHTS DE SUPERFICIE / SURFACE MINI DOWNLIGHTS / MINI-DOWNLIGHTS DE SURFACE



LUA Pag. 26



ELIO Pag. 26



New



MOON Pag. 27

New



DOWNLIGHTS DE SUPERFICIE / SURFACE DOWNLIGHTS / DOWNLIGHTS DE SURFACE



ELSA Pag. 29



ELLEN Pag. 30

DOWNLIGHTS DE SUSPENSIÓN / PENDANT LUMINAIRES / DOWNLIGHTS À SUSPENSION



ELLEN Pag. 32

LINEAR LIGHT



ORNA Pag. 34-36

ÍNDICE / INDEX / INDICE

LUMINARIAS DE ESCAYOLA / PLASTER LUMINAIRES / LUMINAIRES EN PLÂTRE



LEK Pag. 38



KIAT Pag. 38



LITAS Pag. 38



WAT Pag. 39



YUAN Pag. 39



TAKA Pag. 39



DIRHAM Pag. 40



DONG Pag. 40



LILAN Pag. 40



SUM Pag. 41



RAND Pag. 41

LUMINARIAS DE CARRIL / TRACK LUMINAIRES / LUMINAIRES SUR RAIL



MOON Pag. 44



ARIES Pag. 45



ORLI Pag. 46



ELLEN Pag. 47

TRACK SYSTEM



TRIFASICO Pag. 49



ACCESORIOS Pag. 49



TRIFASICO DALI Pag. 50



ACCESORIOS DALI Pag. 50

ILUMINACIÓN DE INTERIOR EMPOTRADA / RECESSED INDOOR LIGHTING / ÉCLAIRAGE INTÉRIEUR ENCASTRÉ

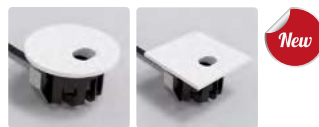

FENIX Pag. 52



ZIRCON Pag. 53

APLIQUES DE INTERIOR / INDOOR APPLIANCES / APPAREILS D'INTÉRIEUR



NELLA Pag. 55



AZAI Pag. 55



KERR Pag. 55



RHODA Pag. 56



ADHAR Pag. 56



NARA Pag. 56

LUMINARIAS LINEAL / LINEAR LUMINAIRES / LUMINAIRES LINÉAIRES



SIMA Empotrar Pag. 58-60



SIMA Superficie Pag. 61-63



ACCESORIOS SIMA Pag. 64

ÍNDICE / INDEX / INDICE

LUMINARIAS DE EMPOTRAR - SUPERFICIE / RECESSED SURFACE - LUMINAIRES / LUMINAIRES ENCASTRÉS - SURFACE



BACKLIT Pag. 66



OMET Pag. 67



GALAXY Pag. 68

MARCOS EMPOTRAR SUPERFICIE / RECESSED SURFACE FRAMES / CADRES ENCASTRÉS SURFACE



SITARA Pag. 69

ILUMINACIÓN INDUSTRIAL / INDUSTRIAL LIGHTING / ÉCLAIRAGE INDUSTRIEL



ANUBIS Pag. 71

LUMINARIAS ESTANCAS / WATERPROOF LUMINAIRES / LUMINAIRES ÉTANCHES



BELA Pag. 73

ILUMINACIÓN DEPORTIVAS Y GRANDES ÁREAS / SPORTS LIGHTING AND LARGE AREAS / ÉCLAIRAGE SPORTIF ET GRANDES SURFACES



APOLO Pag. 75



PEGASO Pag. 76



GOLDEN Pag. 78



STAR Pag. 79



BETTER Pag. 80

ILUMINACIÓN EXTERIOR DE EMPOTRAR / OUTDOOR RECESSED LIGHTING / ÉCLAIRAGE ENCASTRÉ EXTÉRIEUR



PILEA Pag. 82



ANDREA Pag. 82



COOPER Pag. 83



VERA Pag. 83



CIANA Pag. 84



HATRIA Pag. 84



ANAN Pag. 85

ÍNDICE / INDEX / INDICE

ILUMINACIÓN EXTERIOR DE SUPERFICIE / OUTDOOR SURFACE LIGHTING / ÉCLAIRAGE DE SURFACE EXTÉRIEUR



ILUMINACIÓN SUBACUÁTICA/ UNDERWATER LIGHTING/ ÉCLAIRAGE SOUS-MARIN



CAIA Pag. 99



ARALE Pag. 100

ILUMINACIÓN DE BAÑO / BATHROOM LIGHTING / ÉCLAIRAGE SALLE DE BAIN



ALEIX Pag. 102



NORAH Pag. 102

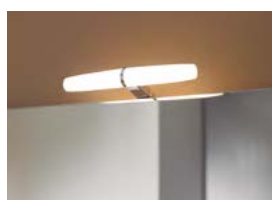

SAHAR Pag. 103



NOA Pag. 103



AFRODITA Pag. 103



VIOLETA Pag. 104



ALTEA Pag. 104

SISTEMAS DE CONTROL/CONTROL SYSTEMS/ SYSTÈMES DE CONTRÔLE



REGULADOR INALAMBRICO AC TRIAC Pag. 106



TUYA INTERRUPTOR ON/OFF Pag. 106



INTERRUPTOR INALAMBRICO ON/OFF Pag. 106



REGULADOR DALI 24V Pag. 107



CONTROLADOR DALI A AC TRIAC Pag. 107



REGULADOR 0/1 - 10V Pag. 108



SMART DRIVER REGULABLE Pag. 109

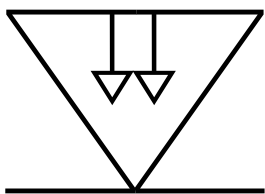

LYOPRO
LEVEL



MINI DOWNLIGHTS DE EMPOTRAR
RECESSED MINI DOWNLIGHTS
MINI DOWNLIGHTS ENCASTRÉS

AGATE

bridgelux
LED CHIP

IP
20

UGR < 19



220-240V
50/60Hz

Alu

Acrylic
Cover



CE

3
Años

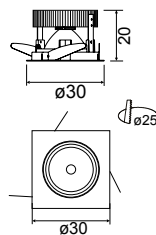
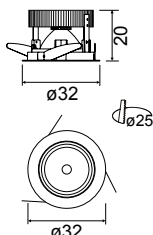
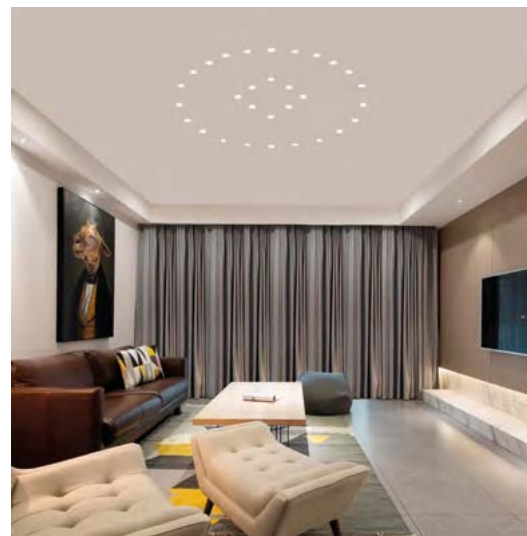

CÓDIGO	W	LM	K	VERSIÓN	ÓPTICA°	Ra/CRI			L	W	H		PVP
60000	1w	95Lm	3000K	Redondo	30	>80	-20+50	<input type="checkbox"/>	32		20	25	11,25€
60001	1w	100Lm	4000K	Redondo	30	>80	-20+50	<input type="checkbox"/>	32		20	25	11,25€
60003	1w	95Lm	3000K	Cuadrado	30	>80	-20+50	<input type="checkbox"/>	30	30	20	25	11,25€
60004	1w	100Lm	4000K	Cuadrado	30	>80	-20+50	<input type="checkbox"/>	30	30	20	25	11,25€

ELIAN

CREE
LED CHIP

LED DRIVER

IP
20

UGR < 19



220-240V
50/60Hz

Alu

Acrylic
Cover



CE

3
Años

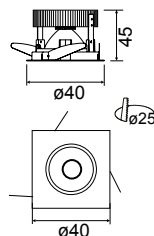
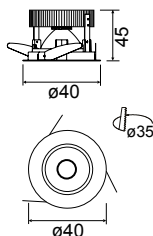
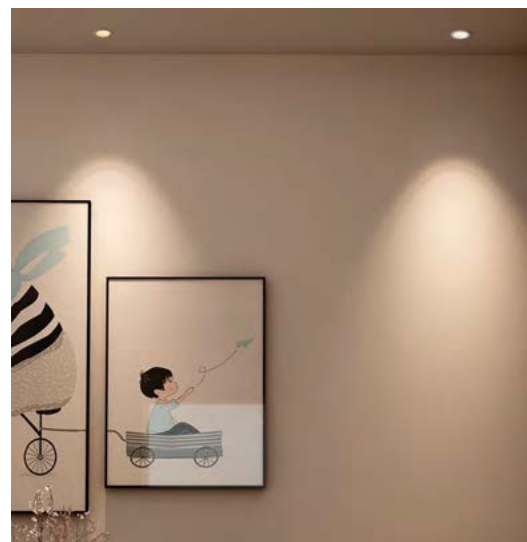

CÓDIGO	W	LM	K	VERSIÓN	ÓPTICA°	Ra/CRI			L	W	H		PVP
60010	3w	285Lm	3000K	Redondo	30	>80	-20+50	<input type="checkbox"/>	40		45	35	22,95€
60011	3w	300Lm	4000K	Redondo	30	>80	-20+50	<input type="checkbox"/>	40		45	35	22,95€
60013	3w	285Lm	3000K	Cuadrado	30	>80	-20+50	<input type="checkbox"/>	40	40	45	35	22,95€
60014	3w	300Lm	4000K	Cuadrado	30	>80	-20+50	<input type="checkbox"/>	40	40	45	35	22,95€

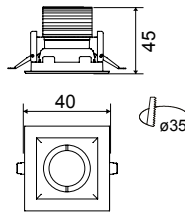
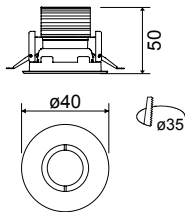

CÓDIGO	W	LM	K	VERSIÓN	ÓPTICA°	Ra/CRI			L	W	H		PVP
60015	3w	270Lm	2700K	Redondo	30	>80	-20+50	B <input type="checkbox"/>	40		50	35	24,95€
60016	3w	285Lm	3000K	Redondo	30	>80	-20+50	B <input type="checkbox"/>	40		50	35	24,95€
60017	3w	300Lm	4000K	Redondo	30	>80	-20+50	B <input type="checkbox"/>	40		50	35	24,95€
60019	3w	285Lm	3000K	Cuadrado	30	>80	-20+50	B <input type="checkbox"/>	40	40	45	35	24,95€
60020	3w	300Lm	4000K	Cuadrado	30	>80	-20+50	B <input type="checkbox"/>	40	40	45	35	24,95€
60021	3w	270Lm	2700K	Redondo	30	>80	-20+50	N <input checked="" type="checkbox"/>	40		50	35	26,95€
60022	3w	285Lm	3000K	Redondo	30	>80	-20+50	N <input checked="" type="checkbox"/>	40		50	35	26,95€
60023	3w	300Lm	4000K	Redondo	30	>80	-20+50	N <input checked="" type="checkbox"/>	40		50	35	26,95€



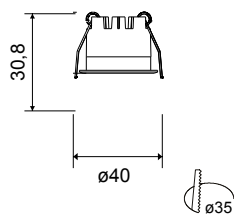

CÓDIGO	W	LM	K	VERSIÓN	ÓPTICA°			L		W	H		PVP
60400	3w	270Lm	2700K	R Redondo	15	B <input type="checkbox"/>	-20+50	40		30,8	35		24,95€
60401	3w	285Lm	3000K		25	N <input checked="" type="checkbox"/>	-20+50	40		30,8	35		24,95€
60402	3w	300Lm	4000K		50	BN <input checked="" type="checkbox"/>	-20+50	40		30,8	35		24,95€
						NB <input checked="" type="checkbox"/>							



LYOPRO
LEVEL



DOWNLIGHTS EMPOTRAR
RECESSED DOWNLIGHTS
DOWNLIGHTS ENCASTRÉS



Available in June

IP
20

PC



CE

3
Años



R
Redondo
Round
Rond



C
Cuadrado
Square
Carrè



RA
Redondo Asimétrico
Asymmetrical Round
Rond Asymetrique



CA
Cuadrado Asimétrico
Asymmetrical Square
Carrè Asymètrique

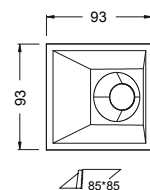
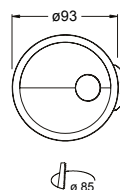
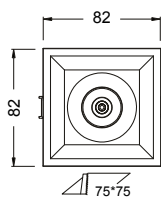
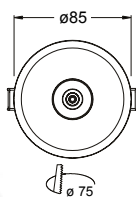

Gu-10 included

CÓDIGO	Ø EXTERIOR	CORTE	ALTURA	VERSIÓN		PVP
12430	85mm	75mm	35mm	Redondo	B <input type="checkbox"/>	6,30€
12431	85mm	75mm	35mm	Redondo	N <input checked="" type="checkbox"/>	6,30€
12436	82x82mm	75mm	35mm	Cuadrado	B <input type="checkbox"/>	6,30€
12437	82x82mm	75mm	35mm	Cuadrado	N <input checked="" type="checkbox"/>	6,30€
12442	93mm	85mm	70mm	Redondo Asimétrico	B <input type="checkbox"/>	6,95€
12443	93mm	85mm	70mm	Redondo Asimétrico	N <input checked="" type="checkbox"/>	6,95€
12448	93x93mm	85mm	70mm	Cuadrado Asimétrico	B <input type="checkbox"/>	6,95€
12449	93x93mm	85mm	70mm	Cuadrado Asimétrico	N <input checked="" type="checkbox"/>	6,95€



recommended lamp
dichroic Smd 7.5w not included

CÓDIGO	W	LM	K	Ø	ÓPTICA°	ELECTRÓNICA	PVP
10220	7,5w	600Lm	2700K	50mm	38	ON/OFF	4,45€
10221	7,5w	620Lm	3000K	50mm	38	ON/OFF	4,45€
10222	7,5w	640Lm	4000K	50mm	38	ON/OFF	4,45€
10224	7,5w	600Lm	2700K	50mm	38	DIMMABLE	8,95€
10225	7,5w	620Lm	3000K	50mm	38	DIMMABLE	8,95€
10226	7,5w	640Lm	4000K	50mm	38	DIMMABLE	8,95€

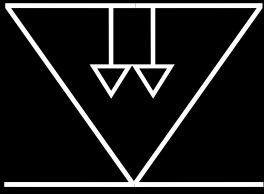

LYOPRO
LEVEL



SIRA



SIRA

CREE LED CHIP

LIFUD LED Driver

UGR < 19



220V-240V
50/60Hz

Alu
PC

EM

Cri>90



CE

3 años

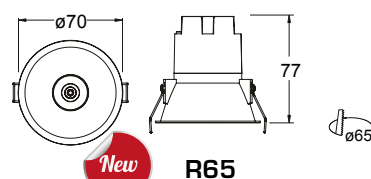
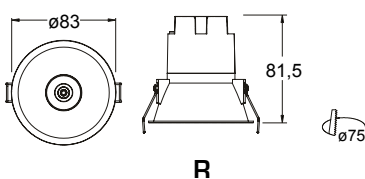

New

Available in April

CÓDIGO	W	LM	K	IP	VERSIÓN	ÓPTICA°		ELECTRÓNICA	PVP (R)	PVP (R65)
60299	5w	450Lm	2700K	IP20	<u>R</u> Redondo	<u>15</u>	<u>B</u>	<u>SR</u> ON/OFF	25,75€	24,95€
60300	5w	475Lm	3000K		<u>R65</u> Redondo	<u>24</u>	<u>N</u>	<u>A</u> TRIAC	41,95€	39,95€
60301	5w	500Lm	4000K			<u>38</u>	<u>BR</u>	<u>B</u> 1-10V	51,95€	49,95€
							<u>BO</u>	<u>C</u> DALI/PUSH	61,95€	59,95€
							<u>BPM</u>			
							<u>BN</u>			

CÓDIGO	W	LM	K	IP	VERSIÓN	ÓPTICA°		ELECTRÓNICA	PVP (R)	PVP (R65)
60299	5w	450Lm	2700K	<u>IP65</u>	<u>R</u> Redondo	<u>15</u>	<u>B</u>	<u>SR</u> ON/OFF	32,75€	31,95€
60300	5w	475Lm	3000K		<u>R65</u> Redondo	<u>24</u>	<u>N</u>	<u>A</u> TRIAC	48,95€	46,95€
60301	5w	500Lm	4000K			<u>38</u>	<u>B</u>	<u>B</u> 1-10V	58,95€	56,95€
							<u>C</u>	<u>C</u> DALI/PUSH	68,95€	66,95€

New

Available in April

SIRA

CREE LED CHIP

LIFUD LED Driver

UGR < 19



220V-240V
50/60Hz

Alu
PC

EM

Cri>90



CE

3 años

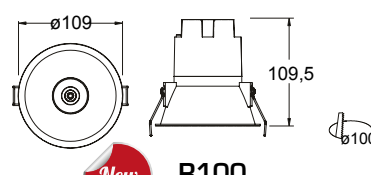
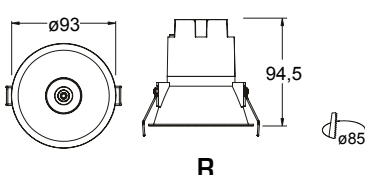

New

Available in April

CÓDIGO	W	LM	K	IP	VERSIÓN	ÓPTICA°		ELECTRÓNICA	PVP (R)	PVP (R100)
60302	10w	900Lm	2700K	IP20	<u>R</u> Redondo	<u>15</u>	<u>B</u>	<u>SR</u> ON/OFF	34,30€	38,95€
60303	10w	950Lm	3000K		<u>R100</u> Redondo	<u>24</u>	<u>N</u>	<u>A</u> TRIAC	49,95€	52,95€
60304	10w	1000Lm	4000K			<u>38</u>	<u>BR</u>	<u>B</u> 1-10V	59,95€	62,95€
							<u>BO</u>	<u>C</u> DALI/PUSH	69,95€	72,95€
							<u>BPM</u>			
							<u>BN</u>			

CÓDIGO	W	LM	K	IP	VERSIÓN	ÓPTICA°		ELECTRÓNICA	PVP (R)	PVP (R100)
60302	10w	900Lm	2700K	<u>IP65</u>	<u>R</u> Redondo	<u>15</u>	<u>B</u>	<u>SR</u> ON/OFF	42,95€	48,95€
60303	10w	950Lm	3000K		<u>R100</u> Redondo	<u>24</u>	<u>N</u>	<u>A</u> TRIAC	58,95€	62,95€
60304	10w	1000Lm	4000K			<u>38</u>	<u>B</u>	<u>B</u> 1-10V	68,95€	72,95€
							<u>C</u>	<u>C</u> DALI/PUSH	78,95€	82,95€

New

Available in April

SIRA

CREE LED CHIP

Lifud LED Driver

UGR < 19



220V-240V
50/60Hz

Alu
PC

EM

Cri>90



CE

3
Años



New

Available in April

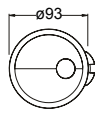

RA

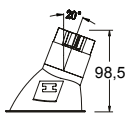

Ø85

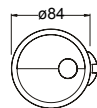

RA75



Ø75

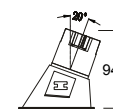
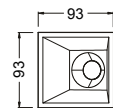

CA

Ø85*85

CÓDIGO	W	LM	K	IP	VERSIÓN	ÓPTICA°		ELECTRÓNICA	PVP (RA-CA)	PVP (RA75)
60299	5w	450Lm	2700K	IP20	RA Redondo Asim.	<u>15</u>	B	SR ON/OFF	26,85€	25,95€
60300	5w	475Lm	3000K		RA75 Redondo Asim.	<u>24</u>	N	A TRIAC	43,95€	42,95€
60301	5w	500Lm	4000K		CA Cuadrado Asim.	<u>38</u>	BR	B 1-10V	53,95€	52,95€
							BO	C DALI/PUSH	63,95€	62,95€
							BPM			
							BN			

SIRA

CREE LED CHIP

Lifud LED Driver

UGR < 19



220V-240V
50/60Hz

Alu
PC

EM

Cri>90



CE

3
Años

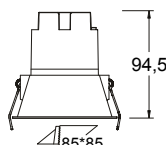
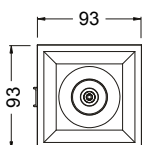

CÓDIGO	W	LM	K	IP	VERSIÓN	ÓPTICA°		ELECTRÓNICA	PVP
60302	10w	900Lm	2700K	IP20	C Cuadrado	<u>15</u>	B	SR ON/OFF	34,30€
60303	10w	950Lm	3000K			<u>24</u>	N	A TRIAC	49,95€
60304	10w	1000Lm	4000K			<u>38</u>	BR	B 1-10V	59,95€
							BO	C DALI/PUSH	69,95€
							BPM		
							BN		

CÓDIGO	W	LM	K	IP	VERSIÓN	ÓPTICA°		ELECTRÓNICA	PVP
60302	10w	900Lm	2700K	I IP65	C Cuadrado	<u>15</u>	B	SR ON/OFF	42,95€
60303	10w	950Lm	3000K			<u>24</u>	N	A TRIAC	58,95€
60304	10w	1000Lm	4000K			<u>38</u>	B	B 1-10V	68,95€
							C	C DALI/PUSH	78,95€

Available in April



LYOPRO
LEVEL



LUNA

IP65
Waterproof grade

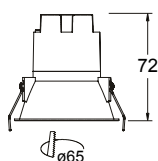
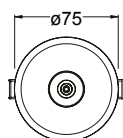

CÓDIGO	W	LM	K	VERSIÓN	ÓPTICA°		ELECTRÓNICA	PVP
60560	8w	720Lm	2700K	Redondo	<u>35</u>	<u>B</u>	<u>SR</u> ON/OFF	69,95€
60561	8w	760Lm	3000K		<u>55</u>	<u>N</u>	<u>A</u> TRIAC	84,95€
60562	8w	800Lm	4000K			<u>B</u>	<u>B</u> 1-10V	89,95€
							<u>C</u> DALI/PUSH	99,95€



Available in June



3000 - 4000 - 6000K

CÓDIGO	W	LM	LM	Ø EXTERIOR		ÓPTICA°		ELECTRÓNICA	PVP
12400	6w	660Lm	3CCT	90mm	75mm	120	B	ON/OFF	9,95€
12400A	6w	660Lm	3CCT	90mm	75mm	120	B	TRIAC	22,95€
12400B	6w	660Lm	3CCT	90mm	75mm	120	B	1-10V	26,95€
12400C	6w	660Lm	3CCT	90mm	75mm	120	B	DALI/PUSH	40,95€
12401	9w	990Lm	3CCT	120mm	105mm	120	B	ON/OFF	10,95€
12401A	9w	990Lm	3CCT	120mm	105mm	120	B	TRIAC	25,95€
12401B	9w	990Lm	3CCT	120mm	105mm	120	B	1-10V	29,95€
12401C	9w	990Lm	3CCT	120mm	105mm	120	B	DALI/PUSH	46,95€
12402	12w	1320Lm	3CCT	140mm	125mm	120	B	ON/OFF	14,95€
12402A	12w	1320Lm	3CCT	140mm	125mm	120	B	TRIAC	29,95€
12402B	12w	1320Lm	3CCT	140mm	125mm	120	B	1-10V	32,95€
12402C	12w	1320Lm	3CCT	140mm	125mm	120	B	DALI/PUSH	49,95€
12403	15w	1650Lm	3CCT	170mm	155mm	120	B	ON/OFF	19,95€
12403A	15w	1650Lm	3CCT	170mm	155mm	120	B	TRIAC	37,95€
12403B	15w	1650Lm	3CCT	170mm	155mm	120	B	1-10V	39,95€
12403C	15w	1650Lm	3CCT	170mm	155mm	120	B	DALI/PUSH	52,95€
12404	20w	2200Lm	3CCT	220mm	200mm	120	B	ON/OFF	23,95€
12404A	20w	2200Lm	3CCT	220mm	200mm	120	B	TRIAC	39,95€
12404B	20w	2200Lm	3CCT	220mm	200mm	120	B	1-10V	41,95€
12404C	20w	2200Lm	3CCT	220mm	200mm	120	B	DALI/PUSH	55,95€

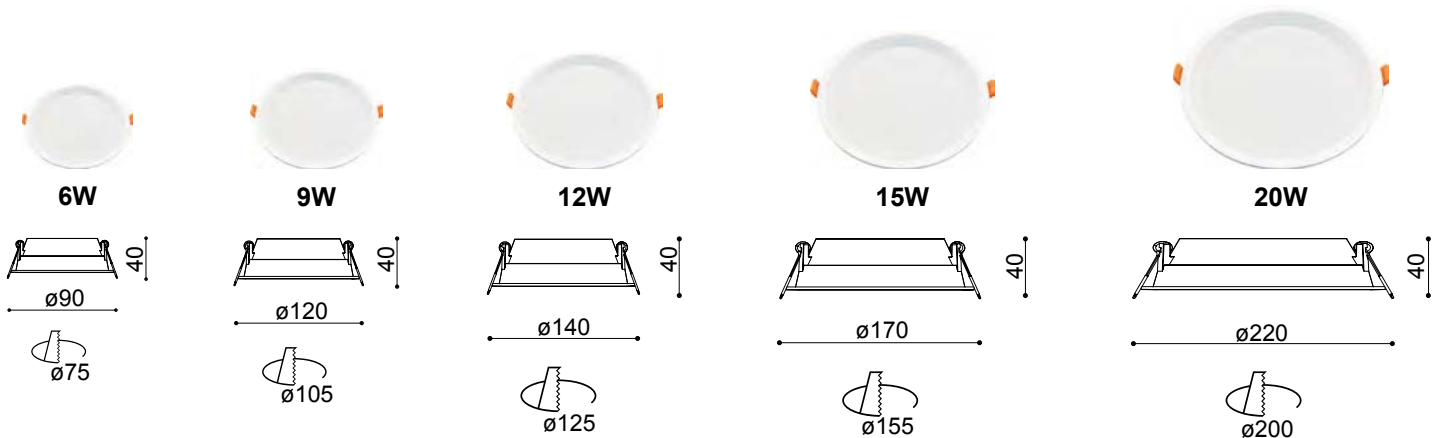



3000 - 4000 - 6000K

CÓDIGO	W	LM	K			ÓPTICA°	ELECTRÓNICA		PVP
60240	7w	770Lm	3 CCT 3000-4000-6000k	70	B <input type="checkbox"/> N <input checked="" type="checkbox"/> P <input type="checkbox"/>	110	SR A B C	ON/OFF TRIAC 1-10V DALI/ PUSH	24,70€ 41,70€ 44,70€ 61,70€

CÓDIGO	W	LM	K			ÓPTICA°	ELECTRÓNICA		PVP
60244	13w	1430Lm	3 CCT 3000-4000-6000k	115	B <input type="checkbox"/> N <input checked="" type="checkbox"/> P <input type="checkbox"/>	110	SR A B C	ON/OFF TRIAC 1-10V DALI/ PUSH	35,35€ 52,35€ 55,35€ 72,35€

CÓDIGO	W	LM	K			ÓPTICA°	ELECTRÓNICA		PVP
60248	15w	1650Lm	3 CCT 3000-4000-6000k	145	B <input type="checkbox"/> N <input checked="" type="checkbox"/> P <input type="checkbox"/>	110	SR A B C	ON/OFF TRIAC 1-10V DALI/ PUSH	42,95€ 59,95€ 62,95€ 79,95€

CÓDIGO	W	LM	K			ÓPTICA°	ELECTRÓNICA		PVP
60252	20w	2200Lm	3 CCT 3000-4000-6000k	165	B <input type="checkbox"/> N <input checked="" type="checkbox"/> P <input type="checkbox"/>	110	SR A B C	ON/OFF TRIAC 1-10V DALI/ PUSH	48,35€ 65,35€ 68,35€ 85,35€

CÓDIGO	W	LM	K			ÓPTICA°	ELECTRÓNICA		PVP
60260	20w	2200Lm	3 CCT 3000-4000-6000k	210	B <input type="checkbox"/> N <input checked="" type="checkbox"/> P <input type="checkbox"/>	110	SR A B C	ON/OFF TRIAC 1-10V DALI/ PUSH	53,70€ 70,70€ 73,70€ 90,70€

CÓDIGO	W	LM	K			ÓPTICA°	ELECTRÓNICA		PVP
60256	30w	3300Lm	3 CCT 3000-4000-6000k	210	B <input type="checkbox"/> N <input checked="" type="checkbox"/> P <input type="checkbox"/>	110	SR A B C	ON/OFF TRIAC 1-10V DALI/ PUSH	61,25€ 78,25€ 81,25€ 98,25€

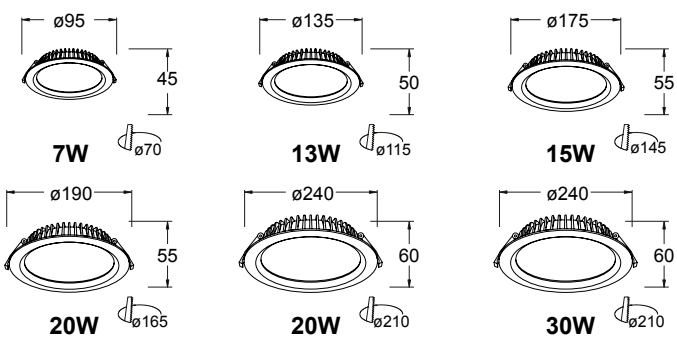



Available in June

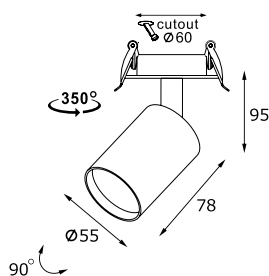

CÓDIGO	MATERIAL		PVP
12320	Aluminio	B	22,95€
12321	Aluminio	N	22,95€



recommended lamp
dichroic Smd 7.5w not included

CÓDIGO	W	LM	K	Ø	ÓPTICA°	ELECTRÓNICA	PVP
10220	7,5w	600Lm	2700K	50mm	38	ON/OFF	4,45€
10221	7,5w	620Lm	3000K	50mm	38	ON/OFF	4,45€
10222	7,5w	640Lm	4000K	50mm	38	ON/OFF	4,45€
10224	7,5w	600Lm	2700K	50mm	38	DIMMABLE	8,95€
10225	7,5w	620Lm	3000K	50mm	38	DIMMABLE	8,95€
10226	7,5w	640Lm	4000K	50mm	38	DIMMABLE	8,95€

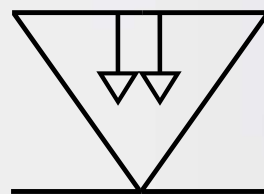

LYOPRO

LEVEL



MINI DOWNLIGHTS DE SUPERFICIE
SURFACE MINI DOWNLIGHTS
MINI DOWNLIGHTS DE SURFACE

LUA

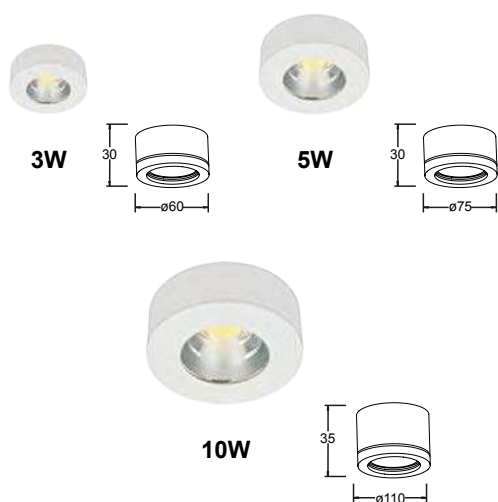
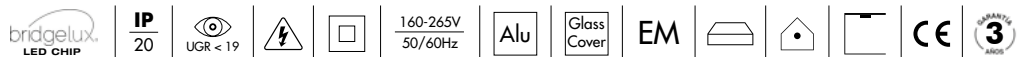

CÓDIGO	W	LM	K	ÓPTICA°	Ra/CRI			L	H	PVP
60050	3w	285Lm	3000K	60	>80	-20+50	B <input type="checkbox"/>	60	30	16,95€
60051	3w	300Lm	4000K	60	>80	-20+50	B <input type="checkbox"/>	60	30	16,95€
60053	5w	475Lm	3000K	60	>80	-20+50	B <input type="checkbox"/>	75	30	22,95€
60054	5w	500Lm	4000K	60	>80	-20+50	B <input type="checkbox"/>	75	30	22,95€
60056	10w	950Lm	3000K	60	>80	-20+50	B <input type="checkbox"/>	110	35	39,95€
60057	10w	1000Lm	4000K	60	>80	-20+50	B <input type="checkbox"/>	110	35	39,95€

ELIO

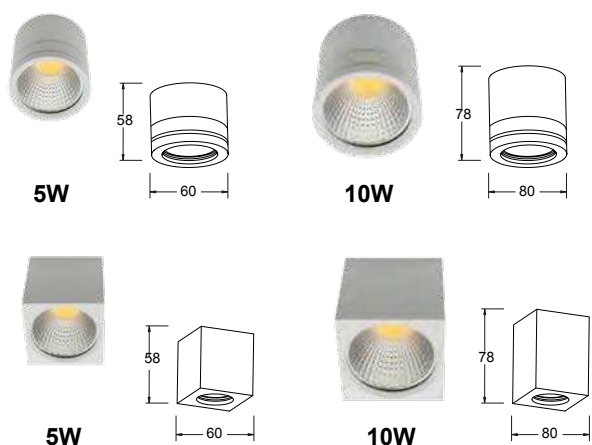
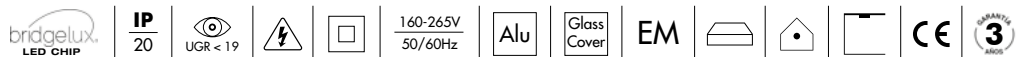

CÓDIGO	W	LM	K	ÓPTICA°	Ra/CRI		VERSIÓN		L	W	H	PVP
60071	5w	475Lm	3000K	60	>80	-20+50	Redondo	B <input type="checkbox"/>	60		58	22,95€
60072	5w	500Lm	4000K	60	>80	-20+50	Redondo	B <input type="checkbox"/>	60		58	22,95€
60080	5w	475Lm	3000K	60	>80	-20+50	Cuadrado	B <input type="checkbox"/>	60	60	58	25,95€
60081	5w	500Lm	4000K	60	>80	-20+50	Cuadrado	B <input type="checkbox"/>	60	60	58	25,95€
60074	10w	950Lm	3000K	60	>80	-20+50	Redondo	B <input type="checkbox"/>	80		78	37,95€
60075	10w	1000Lm	4000K	60	>80	-20+50	Redondo	B <input type="checkbox"/>	80		78	37,95€
60083	10w	950Lm	3000K	60	>80	-20+50	Cuadrado	B <input type="checkbox"/>	80	80	78	42,95€
60084	10w	1000Lm	4000K	60	>80	-20+50	Cuadrado	B <input type="checkbox"/>	80	80	78	42,95€

MOON

GU-10

IP
20

220-245V
50/60Hz

Alu

EM



CE

3

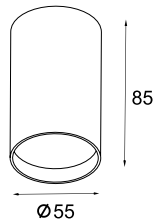

Available in June



CÓDIGO	MATERIAL		PVP
12300	Aluminio	B <input type="checkbox"/>	17,95€
12301	Aluminio	N <input type="checkbox"/>	17,95€

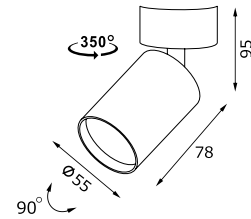

Available in June

CÓDIGO	MATERIAL		PVP
12310	Aluminio	B <input type="checkbox"/>	24,95€
12311	Aluminio	N <input type="checkbox"/>	24,95€



recommended lamp
dichroic Smd 7.5w not included

CÓDIGO	W	LM	K	Ø	ÓPTICA°	ELECTRÓNICA	PVP
10220	7,5w	600Lm	2700K	50mm	38	ON/OFF	4,45€
10221	7,5w	620Lm	3000K	50mm	38	ON/OFF	4,45€
10222	7,5w	640Lm	4000K	50mm	38	ON/OFF	4,45€
10224	7,5w	600Lm	2700K	50mm	38	DIMMABLE	8,95€
10225	7,5w	620Lm	3000K	50mm	38	DIMMABLE	8,95€
10226	7,5w	640Lm	4000K	50mm	38	DIMMABLE	8,95€

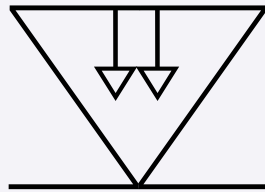

LYOPRO
LEVEL

DOWNLIGHTS DE SUPERFICIE
SURFACE DOWNLIGHTS
DOWNLIGHTS DE SURFACE

10W

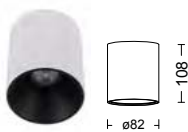

20W

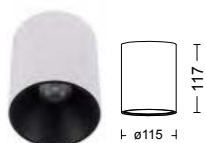

30W

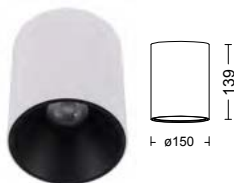

40W

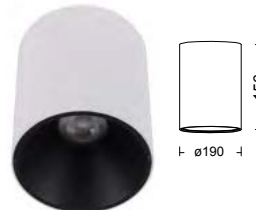

CÓDIGO	W	LM	K	EXTERIOR	ÓPTICA°	Ra/CRI	INTERIOR	ELECTRÓNICA	PVP
60500	10w	970Lm	3000K	B <input type="checkbox"/>	45	>90	B <input type="checkbox"/>	SR ON/OFF	76,95€
60501	10w	1000Lm	4000K	B <input type="checkbox"/>	45	>90	N <input checked="" type="checkbox"/>	A TRIAC	156,90€
60503	10w	970Lm	3000K	N <input checked="" type="checkbox"/>	45	>90	PB <input type="checkbox"/>	B 1-10V	199,95€
60504	10w	1000Lm	4000K	N <input checked="" type="checkbox"/>	45	>90	PM <input type="checkbox"/>	C DALI/PUSH	199,95€
							O <input type="checkbox"/>		

CÓDIGO	W	LM	K	EXTERIOR	ÓPTICA°	Ra/CRI	INTERIOR	ELECTRÓNICA	PVP
60506	20w	1960Lm	3000K	B <input type="checkbox"/>	45	>90	B <input type="checkbox"/>	SR ON/OFF	119,95€
60507	20w	2000Lm	4000K	B <input type="checkbox"/>	45	>90	N <input checked="" type="checkbox"/>	A TRIAC	156,90€
60509	20w	1960Lm	3000K	N <input checked="" type="checkbox"/>	45	>90	PB <input type="checkbox"/>	B 1-10V	166,60€
60510	20w	2000Lm	4000K	N <input checked="" type="checkbox"/>	45	>90	PM <input type="checkbox"/>	C DALI/PUSH	166,60€
							O <input type="checkbox"/>		

CÓDIGO	W	LM	K	EXTERIOR	ÓPTICA°	Ra/CRI	INTERIOR	ELECTRÓNICA	PVP
60512	30w	2920Lm	3000K	B <input type="checkbox"/>	45	>90	B <input type="checkbox"/>	SR ON/OFF	169,95€
60513	30w	3000Lm	4000K	B <input type="checkbox"/>	45	>90	N <input checked="" type="checkbox"/>	A TRIAC	193,50€
60515	30w	2920Lm	3000K	N <input checked="" type="checkbox"/>	45	>90	PB <input type="checkbox"/>	B 1-10V	199,95€
60516	30w	3000Lm	4000K	N <input checked="" type="checkbox"/>	45	>90	PM <input type="checkbox"/>	C DALI/PUSH	199,95€
							O <input type="checkbox"/>		

CÓDIGO	W	LM	K	EXTERIOR	ÓPTICA°	Ra/CRI	INTERIOR	ELECTRÓNICA	PVP
60518	40w	3900Lm	3000K	B <input type="checkbox"/>	45	>90	B <input type="checkbox"/>	SR ON/OFF	229,95€
60519	40w	4000Lm	4000K	B <input type="checkbox"/>	45	>90	N <input checked="" type="checkbox"/>	A TRIAC	242,95€
60521	40w	3900Lm	3000K	N <input checked="" type="checkbox"/>	45	>90	PB <input type="checkbox"/>	B 1-10V	247,25€
60522	40w	4000Lm	4000K	N <input checked="" type="checkbox"/>	45	>90	PM <input type="checkbox"/>	C DALI/PUSH	247,25€
							O <input type="checkbox"/>		

KIT SUSPENSIÓN ELSA

CÓDIGO	METROS	PVP
60546	1,5	21,45€
60547	3	23,60€
60548	5	25,75€

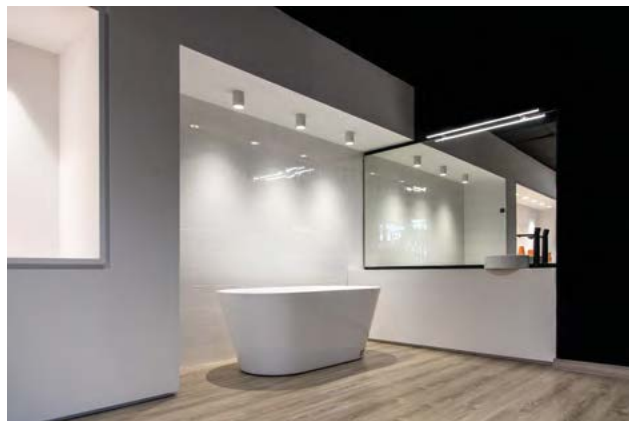



CÓDIGO	W	LM	K	Ra/CRI	INSTALACIÓN	EXTERIOR		INTERIOR		ELECTRÓNICA	PVP
						ÓPTICA°	ÓPTICA°				
61400	7w	610Lm	3000K	>90	<u>S</u> Superficie	N <input checked="" type="checkbox"/>	18	B <input type="checkbox"/>	SR	ON/OFF	78,95€
61401	7w	630Lm	4000K	>90		N <input checked="" type="checkbox"/>	30	N <input checked="" type="checkbox"/>	A	TRIAC	98,95€
61403	7w	610Lm	3000K	>90		B <input type="checkbox"/>	40	PB <input type="checkbox"/>	B	1-10V	108,95€
61404	7w	630Lm	4000K	>90		B <input type="checkbox"/>		PM <input type="checkbox"/>	C	DALI/PUSH	118,95€
								O <input type="checkbox"/>			

CÓDIGO	W	LM	K	Ra/CRI	INSTALACIÓN	EXTERIOR		INTERIOR		ELECTRÓNICA	PVP
						ÓPTICA°	ÓPTICA°				
61406	12w	1060Lm	3000K	>90	<u>S</u> Superficie	N <input checked="" type="checkbox"/>	15	B <input type="checkbox"/>	SR	ON/OFF	99,95€
61407	12w	1080Lm	4000K	>90		N <input checked="" type="checkbox"/>	20	N <input checked="" type="checkbox"/>	A	TRIAC	119,95€
61409	12w	1060Lm	3000K	>90		B <input type="checkbox"/>	30	PB <input type="checkbox"/>	B	1-10V	129,95€
61410	12w	1080Lm	4000K	>90		B <input type="checkbox"/>	40	PM <input type="checkbox"/>	C	DALI/PUSH	139,95€
							50	O <input type="checkbox"/>			

CÓDIGO	W	LM	K	Ra/CRI	INSTALACIÓN	EXTERIOR		INTERIOR		ELECTRÓNICA	PVP
						ÓPTICA°	ÓPTICA°				
61412	20w	1780Lm	3000K	>90	<u>S</u> Superficie	N <input checked="" type="checkbox"/>	15	B <input type="checkbox"/>	SR	ON/OFF	119,95€
61413	20w	1800Lm	4000K	>90		N <input checked="" type="checkbox"/>	20	N <input checked="" type="checkbox"/>	A	TRIAC	139,95€
61415	20w	1780Lm	3000K	>90		B <input type="checkbox"/>	45	PB <input type="checkbox"/>	B	1-10V	149,95€
61416	20w	1800Lm	4000K	>90		B <input type="checkbox"/>	55	PM <input type="checkbox"/>	C	DALI/PUSH	159,95€
								O <input type="checkbox"/>			

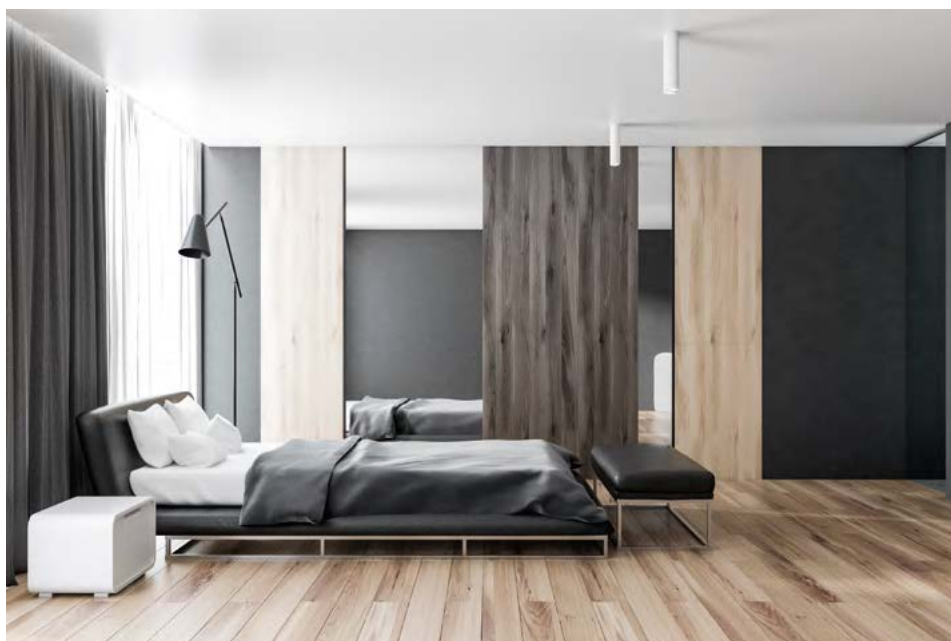



LYOPRO

LEVEL



LUMINARIAS DE SUSPENSIÓN
PENDANT LUMINAIRES
LUMINAIRES À SUSPENSION

7W

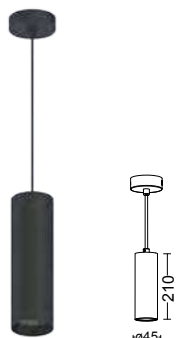

12W



20W

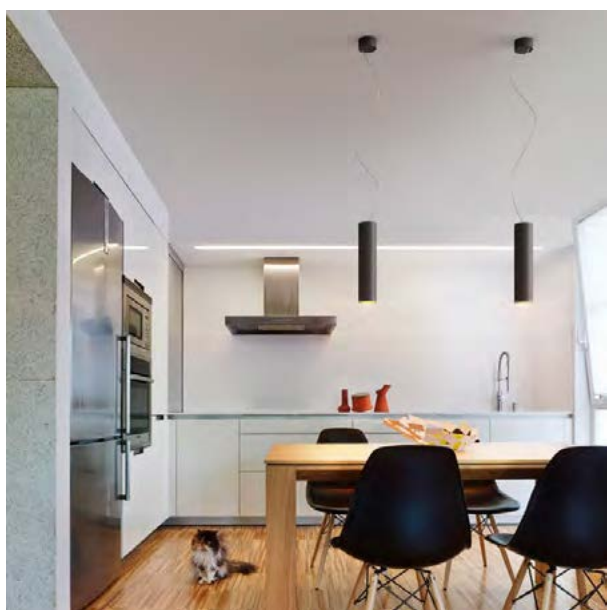
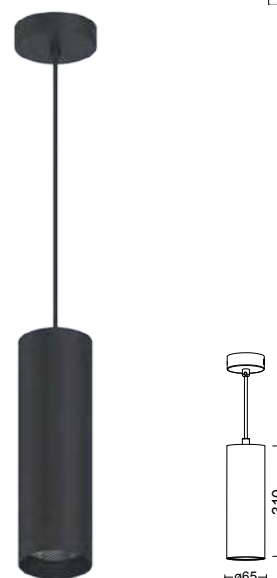

CÓDIGO	W	LM	K	Ra/CRI	INSTALACIÓN	ÓPTICA°		ELECTRÓNICA	PVP
						EXTERIOR	INTERIOR		
61400	7w	610Lm	3000K	>90	C Colgante	N <input checked="" type="checkbox"/>	18	SR ON/OFF	78,95€
61401	7w	630Lm	4000K	>90		N <input checked="" type="checkbox"/>	30	A TRIAC	98,95€
61403	7w	610Lm	3000K	>90		B <input type="checkbox"/>	40	B 1-10V	108,95€
61404	7w	630Lm	4000K	>90		B <input type="checkbox"/>		C DALI/PUSH	118,95€

CÓDIGO	W	LM	K	Ra/CRI	INSTALACIÓN	ÓPTICA°		ELECTRÓNICA	PVP
						EXTERIOR	INTERIOR		
61406	12w	1060Lm	3000K	>90	C Colgante	N <input checked="" type="checkbox"/>	15	SR ON/OFF	99,95€
61407	12w	1080Lm	4000K	>90		N <input checked="" type="checkbox"/>	20	A TRIAC	119,95€
61409	12w	1060Lm	3000K	>90		B <input type="checkbox"/>	30	B 1-10V	129,95€
61410	12w	1080Lm	4000K	>90		B <input type="checkbox"/>	40 50	C DALI/PUSH	139,95€

CÓDIGO	W	LM	K	Ra/CRI	INSTALACIÓN	ÓPTICA°		ELECTRÓNICA	PVP
						EXTERIOR	INTERIOR		
61412	20w	1780Lm	3000K	>90	C Colgante	N <input checked="" type="checkbox"/>	15	SR ON/OFF	119,95€
61413	20w	1800Lm	4000K	>90		N <input checked="" type="checkbox"/>	20	A TRIAC	139,95€
61415	20w	1780Lm	3000K	>90		B <input type="checkbox"/>	45	B 1-10V	149,95€
61416	20w	1800Lm	4000K	>90		B <input type="checkbox"/>	55	C DALI/PUSH	159,95€



LINEAR LIGHT

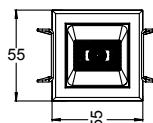
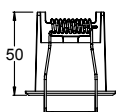

CÓDIGO	W	LM	K	Ra/CRI			ÓPTICA°	ELECTRÓNICA	PVP
60600	5w	475Lm	3000K	>90	-10+45	BN	12	SR ON/OFF	32,15€
60601	5w	500Lm	4000K	>90	-10+45	BN	23	A TRIAC	69,85€
60650	5w	475Lm	3000K	>90	-10+45	N	38	B 1-10V	75,25€
60651	5w	500Lm	4000K	>90	-10+45	N	50	C DALI/PUSH	75,25€
							3570 (35+70)		
							5050 (50+50)		

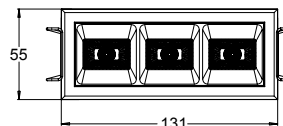
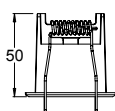
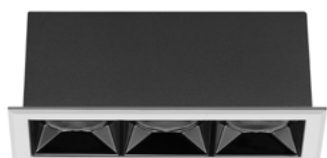

CÓDIGO	W	LM	K	Ra/CRI			ÓPTICA°	ELECTRÓNICA	PVP
60603	12w	1140Lm	3000K	>90	-10+45	BN	12	SR ON/OFF	64,40€
60604	12w	1200Lm	4000K	>90	-10+45	BN	23	A TRIAC	96,70€
60653	12w	1140Lm	3000K	>90	10+45	N	38	B 1-10V	102,10€
60654	12w	1200Lm	4000K	>90	-10+45	N	50	C DALI/PUSH	102,10€
							3570 (35+70)		
							5050 (50+50)		
							W (Wallwasher)		

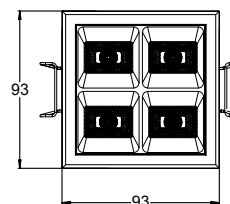
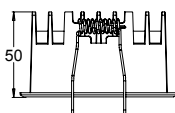

CÓDIGO	W	LM	K	Ra/CRI			ÓPTICA°	ELECTRÓNICA	PVP
60606	15w	1425Lm	3000K	>90	-10+45	BN	12	SR ON/OFF	96,65€
60607	15w	1500Lm	4000K	>90	-10+45	BN	23	A TRIAC	113,95€
60656	15w	1425Lm	3000K	>90	-10+45	N	38	B 1-10V	124,70€
60657	15w	1500Lm	4000K	>90	-10+45	N	50	C DALI/PUSH	124,70€
							3570 (35+70)		
							5050 (50+50)		

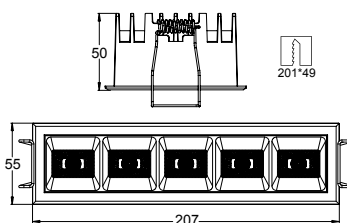
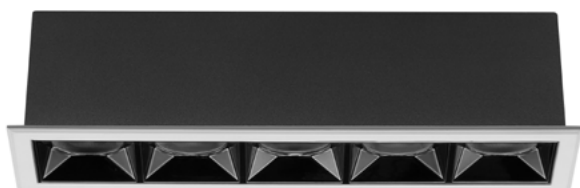

CÓDIGO	W	LM	K	Ra/CRI			ÓPTICA°	ELECTRÓNICA	PVP
60609	20w	1900Lm	3000K	>90	-10+45	BN	<u>12</u>	<u>SR</u> ON/OFF	107,40€
60610	20w	2000Lm	4000K	>90	-10+45	BN	<u>23</u>	<u>A</u> TRIAC	128,95€
60659	20w	1900Lm	3000K	>90	-10+45	N	<u>38</u>	<u>B</u> 1-10V	139,75€
60660	20w	2000Lm	4000K	>90	-10+45	N	<u>50</u>	<u>C</u> DALI/PUSH	139,75€
							<u>3570</u> (35+70)		
							<u>5050</u> (50+50)		
							<u>W</u> (Wallwasher)		

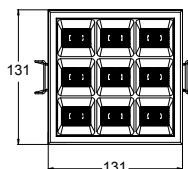
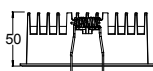

CÓDIGO	W	LM	K	Ra/CRI			ÓPTICA°	ELECTRÓNICA	PVP
60640	36w	3420Lm	3000K	>90	-10+45	BN	<u>12</u>	<u>SR</u> ON/OFF	150,45€
60641	36w	3600Lm	4000K	>90	-10+45	BN	<u>23</u>	<u>A</u> TRIAC	171,95€
60670	36w	3420Lm	3000K	>90	-10+45	N	<u>38</u>	<u>B</u> 1-10V	182,70€
60671	36w	3600Lm	4000K	>90	-10+45	N	<u>50</u>	<u>C</u> DALI/PUSH	182,70€
							<u>3570</u> (35+70)		
							<u>5050</u> (50+50)		

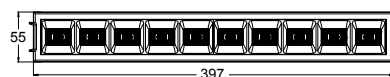
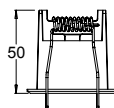

CÓDIGO	W	LM	K	Ra/CRI			ÓPTICA°	ELECTRÓNICA	PVP
60643	40w	3800Lm	3000K	>90	-10+45	BN	<u>12</u>	<u>SR</u> ON/OFF	166,60€
60644	40w	4000Lm	4000K	>90	-10+45	BN	<u>23</u>	<u>A</u> TRIAC	188,10€
60673	40w	3800Lm	3000K	>90	-10+45	N	<u>38</u>	<u>B</u> 1-10V	209,60€
60674	40w	4000Lm	4000K	>90	-10+45	N	<u>50</u>	<u>C</u> DALI/PUSH	209,60€
							<u>3570</u> (35+70)		
							<u>5050</u> (50+50)		
							<u>W</u> (Wallwasher)		

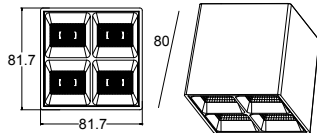

CÓDIGO	W	LM	K	Ra/CRI			ÓPTICA°	ELECTRÓNICA	PVP
60680	15w	1425Lm	3000K	>90	-10+45	BN	12	SR ON/OFF	96,65€
60681	15w	1500Lm	4000K	>90	-10+45	BN	23	A TRIAC	113,95€
60686	15w	1425Lm	3000K	>90	-10+45	N	38	B 1-10V	124,70€
60687	15w	1500Lm	4000K	>90	-10+45	N	50	C DALI/PUSH	124,70€
							3570 (35+70)		
							5050 (50+50)		

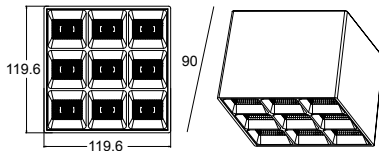

CÓDIGO	W	LM	K	Ra/CRI			ÓPTICA°	ELECTRÓNICA	PVP
60683	36w	3420Lm	3000K	>90	-10+45	BN	12	SR ON/OFF	150,45€
60684	36w	3600Lm	4000K	>90	-10+45	BN	23	A TRIAC	171,95€
60689	36w	3420Lm	3000K	>90	-10+45	N	38	B 1-10V	182,70€
60690	36w	3600Lm	4000K	>90	-10+45	N	50	C DALI/PUSH	182,70€
							3570 (35+70)		
							5050 (50+50)		

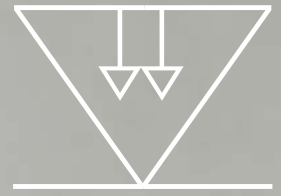

LYOPRO
LEVEL

LUMINARIAS DE ESCAYOLA
PLASTER LUMINAIRES
LUMINAIRES EN PLÂTRE

LEK

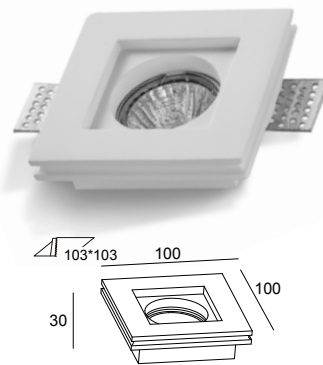
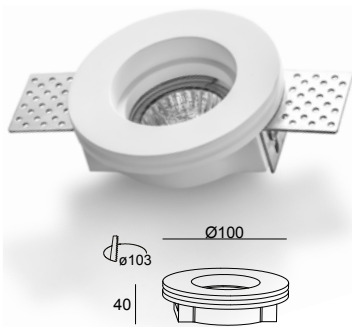

* Lamp not included

CÓDIGO	TIPO LÁMPARA	MATERIAL	VERSIÓN	Color	Dimensions			Mounting	PVP
					L	W	H		
60135	GU-10	Yeso	Redondo	B <input type="checkbox"/>	100	40	103	12,95€	
60136	GU-10	Yeso	Cuadrado	B <input type="checkbox"/>	100	100	30	12,95€	

KIAT

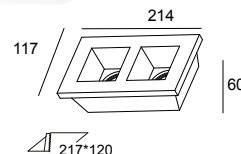
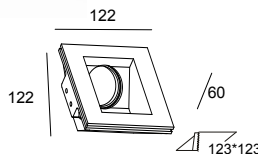
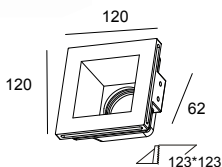

* Lamp not included

CÓDIGO	TIPO LÁMPARA	MATERIAL	VERSIÓN	Color	Dimensions			Mounting	PVP
					L	W	H		
60137	GU-10	Yeso	Cuadrado	B <input type="checkbox"/>	120	120	62	123*123	13,45€
60138	GU-10	Yeso	Cuadrado Asimétrico	B <input type="checkbox"/>	122	122	60	123*123	13,45€
60139	GU-10	Yeso	Rectangular	B <input type="checkbox"/>	214	117	60	217*120	25,25€

LITAS

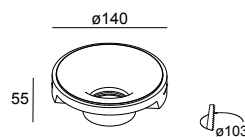

* Lamp not included

CÓDIGO	TIPO LÁMPARA	MATERIAL	VERSIÓN	Color	Dimensions		Mounting	PVP
					L	H		
60143	GU-10	Yeso	Redondo	B <input type="checkbox"/>	140	55	143	15,00€

WAT



IP
20



220-240V
50/60Hz



TRIMLESS

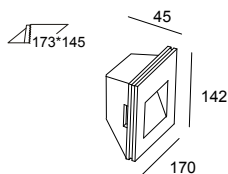

CÓDIGO	W	LM	K	ÓPTICA°	Ra/CRI			L	W	H		PVP
60149	1w	90Lm	2700K	100	>80	-20+45	B <input type="checkbox"/>	170	142	45	173*145	50,50€
60150	1w	95Lm	3000K	100	>80	-20+45	B <input type="checkbox"/>	170	142	45	173*145	50,50€
60151	1w	100Lm	4000K	100	>80	-20+45	B <input type="checkbox"/>	170	142	45	173*145	50,50€

YUAN



IP
20



220-240V
50/60Hz



TRIMLESS

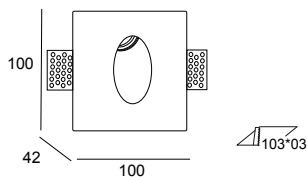

CÓDIGO	W	LM	K	ÓPTICA°	Ra/CRI			L	W	H		PVP
60152	1w	90Lm	2700K	100	>80	-20+45	B <input type="checkbox"/>	100	100	42	103*103	45,70€
60153	1w	95Lm	3000K	100	>80	-20+45	B <input type="checkbox"/>	100	100	42	103*103	45,70€
60154	1w	100Lm	4000K	100	>80	-20+45	B <input type="checkbox"/>	100	100	42	103*103	45,70€

TAKA



IP
20



220-240V
50/60Hz



TRIMLESS

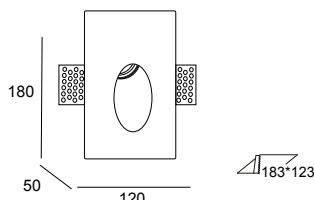

CÓDIGO	W	LM	K	ÓPTICA	Ra/CRI			L	W	H		PVP
60155	1w	90Lm	2700K	100	>80	-20+45	B <input type="checkbox"/>	180	120	50	183*123	49,95€
60156	1w	95Lm	3000K	100	>80	-20+45	B <input type="checkbox"/>	180	120	50	183*123	49,95€
60157	1w	100Lm	4000K	100	>80	-20+45	B <input type="checkbox"/>	180	120	50	183*123	49,95€

DIRHAM

IP 20 | 220-240V 50/60Hz | | | | TRIMLESS | | | CE |

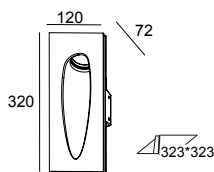

* Lamp not included

CÓDIGO	TIPO LÁMPARA	MATERIAL	VERSIÓN		L	W	H		PVP
60159	GU-10	Yeso	Rectangular	B	320	120	72	323*323	68,55€

DONG

IP 20 | 220-240V 50/60Hz | | | | TRIMLESS | | | CE |

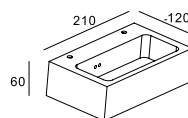

* Lamp not included

CÓDIGO	TIPO LÁMPARA	MATERIAL	VERSIÓN		L	W	H	PVP
60181	E-14	Yeso	Rectangular	B	210	60	120	53,45€

LILAN

IP 20 | 220-240V 50/60Hz | | | | TRIMLESS | | | CE |

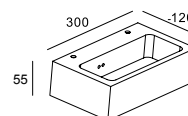

* Lamp not included

CÓDIGO	TIPO LÁMPARA	MATERIAL	VERSIÓN		L	W	H	PVP
60182	R7S	Yeso	Rectangular	B	300	55	120	79,95€

SUM

IP 20 | 220-240V 50/60Hz | | | | TRIMLESS | | | CE |

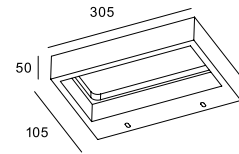

* Lamp not included

CÓDIGO	TIPO LÁMPARA	MATERIAL	VERSIÓN			L	W	H	PVP
60180	R7S	Yeso	Rectangular			305	50	105	68,55€

RAND

IP 20 | 220-240V 50/60Hz | | | | TRIMLESS | | | CE |

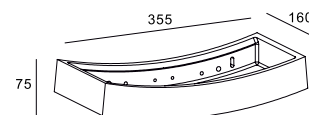

* Lamp not included

CÓDIGO	TIPO LÁMPARA	MATERIAL	VERSIÓN			L	W	H	PVP
60183	R7S	Yeso	Curvo			355	75	160	57,15€

RECOMENDACIONES DE INSTALACIÓN
INSTALLATION RECOMMENDATIONS
RECOMMANDATIONS D'INSTALLATION



IMAGEN 1



IMAGEN 2



IMAGEN 3



IMAGEN 4



IMAGEN 5



IMAGEN 6



IMAGEN 7



IMAGEN 8



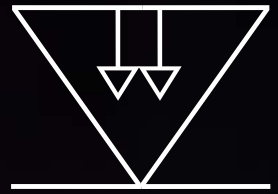

LYOPRO
LEVEL



LUMINARIAS DE CARRIL
TRACK LUMINAIRES
LUMINAIRES SUR RAIL

MOON

GU-10 | TRIFÁSICO | IP 20 | 220-245V 50/60Hz | Alu | EM |    | CE |  | 



Available in June

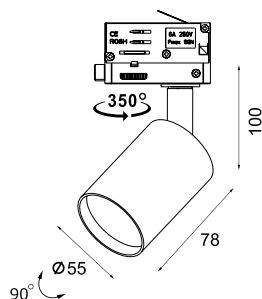

CÓDIGO	MATERIAL		PVP
12330	Aluminio	B <input type="checkbox"/>	29,95€
12331	Aluminio	N <input type="checkbox"/>	29,95€



recommended lamp
dichroic Smd 7.5w not included

CÓDIGO	W	LM	K	Ø	ÓPTICA°	ELECTRÓNICA	PVP
10220	7,5w	600Lm	2700K	50mm	38	ON/OFF	4,45€
10221	7,5w	620Lm	3000K	50mm	38	ON/OFF	4,45€
10222	7,5w	640Lm	4000K	50mm	38	ON/OFF	4,45€
10224	7,5w	600Lm	2700K	50mm	38	DIMMABLE	8,95€
10225	7,5w	620Lm	3000K	50mm	38	DIMMABLE	8,95€
10226	7,5w	640Lm	4000K	50mm	38	DIMMABLE	8,95€



2700 - 3000 - 4000K



Available in June

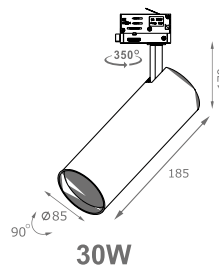
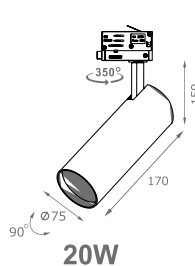
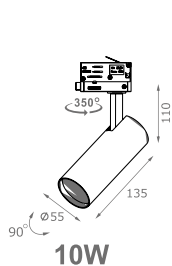

CÓDIGO	W	LM	K	ÓPTICA°		CRI		L	H	ELECTRÓNICA	PVP
61550	10w	1200Lm	3 CCT	15	B <input type="checkbox"/>	<90	-30+50	55	135	ON/OFF	69,95€
61551	10w	1200Lm	3 CCT	24	N <input checked="" type="checkbox"/>	<90	-30+50	55	135	ON/OFF	69,95€
61552	20w	2400Lm	3 CCT	38	B <input type="checkbox"/>	<90	-30+50	75	170	ON/OFF	99,95€
61553	20w	2400Lm	3 CCT	45	N <input checked="" type="checkbox"/>	<90	-30+50	75	170	ON/OFF	99,95€
61554	30w	3600Lm	3 CCT	60	B <input type="checkbox"/>	<90	-30+50	85	185	ON/OFF	119,95€
61555	30w	3600Lm	3 CCT		N <input checked="" type="checkbox"/>	<90	-30+50	85	185	ON/OFF	119,95€





3000 - 4000 - 6000K

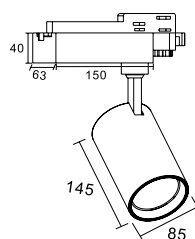

CÓDIGO	W	LM	K	ÓPTICA°		UGR		L	H	ELECTRÓNICA	PVP
61500	34w	3400Lm	3 CCT	30	B	<19	-30+50	85	145	SR ON/OFF	195,95€
61507	34w	3400Lm	3 CCT	38 60	N	<19	-30+50	85	145	A TRIAC	219,95€

ACCESORIOS ORLI

MODULO CONFORT VISUAL
UGR13 NEGRO
CÓDIGO: 61526
PVP: 21,40€



PANEL DE ABEJA
UGR9 NEGRO
CÓDIGO: 61527
PVP: 26,75€



REFLECTOR ALU CON ARO 60°
CÓDIGO: 61528 NEGRO
PVP: 21,40€



ALETAS
ANTIDESLUMBRAMIENTO
CÓDIGO: 61530 NEGRA
PVP: 26,75€



CÓDIGO: 61529 BLANCA
PVP: 21,40€

CÓDIGO: 61531 BLANCA
PVP: 26,75€





7W

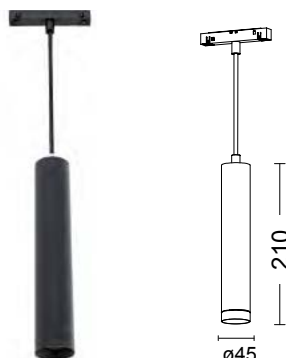

12W

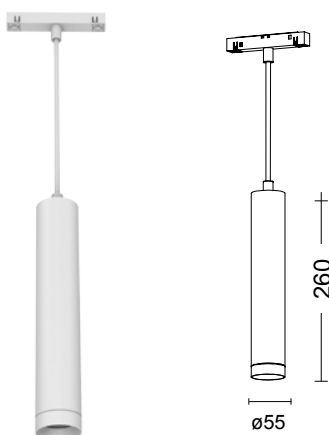

20W

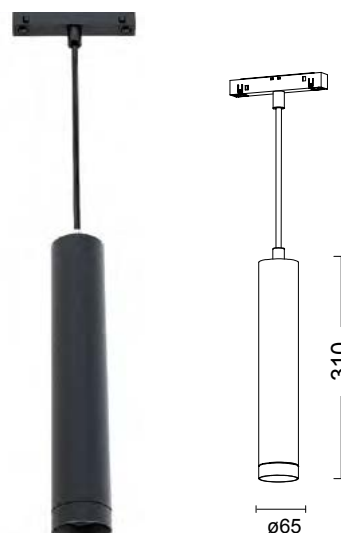

CÓDIGO	W	LM	K	INSTALACIÓN	EXTERIOR	ÓPTICA°	INTERIOR	ELECTRÓNICA	PVP
61400	7w	610Lm	3000K	CC Colgante Carril	N <input checked="" type="checkbox"/>	18	B <input type="checkbox"/>	SR ON/OFF	89,95€
61401	7w	630Lm	4000K		N <input checked="" type="checkbox"/>	30	N <input checked="" type="checkbox"/>	A TRIAC	119,95€
61403	7w	610Lm	3000K		B <input type="checkbox"/>	40	PB <input type="checkbox"/>	B 1-10V	129,95€
61404	7w	630Lm	4000K		B <input type="checkbox"/>		PM <input type="checkbox"/>	C PUSH/DALI	139,95€

CÓDIGO	W	LM	K	INSTALACIÓN	EXTERIOR	ÓPTICA°	INTERIOR	ELECTRÓNICA	PVP
61406	12w	1060Lm	3000K	CC Colgante Carril	N <input checked="" type="checkbox"/>	15	B <input type="checkbox"/>	SR ON/OFF	109,95€
61407	12w	1080Lm	4000K		N <input checked="" type="checkbox"/>	20	N <input checked="" type="checkbox"/>	A TRIAC	129,95€
61409	12w	1060Lm	3000K		B <input type="checkbox"/>	30	PB <input type="checkbox"/>	B 1-10V	139,95€
61410	12w	1080Lm	4000K		B <input type="checkbox"/>	40	PM <input type="checkbox"/>	C PUSH/DALI	149,95€

CÓDIGO	W	LM	K	INSTALACIÓN	EXTERIOR	ÓPTICA°	INTERIOR	ELECTRÓNICA	PVP
61412	20w	1780Lm	3000K	CC Colgante Carril	N <input checked="" type="checkbox"/>	15	B <input type="checkbox"/>	SR ON/OFF	129,95€
61413	20w	1800Lm	4000K		N <input checked="" type="checkbox"/>	20	N <input checked="" type="checkbox"/>	A TRIAC	149,95€
61415	20w	1780Lm	3000K		B <input type="checkbox"/>	45	PB <input type="checkbox"/>	B 1-10V	159,95€
61416	20w	1800Lm	4000K		B <input type="checkbox"/>	55	PM <input type="checkbox"/>	C PUSH/DALI	169,95€

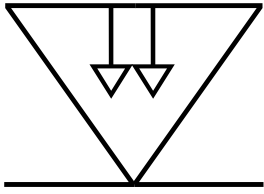

LYOPRO
LEVEL



TRACK SYSTEM

TRACK SYSTEM TRIFÁSICO

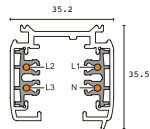

CARRIL TRIFÁSICO SUPERFICIE DE 1 METRO
NEGRO **CÓDIGO:** 62496
BLANCO **CÓDIGO:** 62497
PVP: 39,75€

CARRIL TRIFÁSICO SUPERFICIE DE 2 METROS
NEGRO **CÓDIGO:** 62504
BLANCO **CÓDIGO:** 62506
PVP: 76,50€

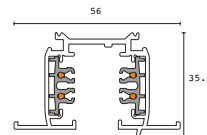

CARRIL TRIFÁSICO EMPOTRAR DE 1 METRO
NEGRO **CÓDIGO:** 62494
BLANCO **CÓDIGO:** 62495
PVP: 50,95€

CARRIL TRIFÁSICO EMPOTRAR DE 2 METROS
NEGRO **CÓDIGO:** 62500
BLANCO **CÓDIGO:** 62502
PVP: 101,50€

ACCESORIOS



ALIMENTADOR TIERRA A IZQUIERDA
NEGRO **CÓDIGO:** 62510
BLANCO **CÓDIGO:** 62511
PVP: 17,50€



ALIMENTADOR TIERRA A DERECHA
NEGRO **CÓDIGO:** 62512
BLANCO **CÓDIGO:** 62513
PVP: 17,50€



UNIÓN ELECTRICA
NEGRO **CÓDIGO:** 62514
BLANCO **CÓDIGO:** 62515
PVP: 9,95€



UNIÓN MECÁNICA
NEGRO **CÓDIGO:** 62516
BLANCO **CÓDIGO:** 62517
PVP: 6,50€



UNIÓN ELECTRICA CENTRAL
NEGRO **CÓDIGO:** 62518
BLANCO **CÓDIGO:** 62519
PVP: 33,35€



TAPA FINAL
NEGRO **CÓDIGO:** 62526
BLANCO **CÓDIGO:** 62527
PVP: 2,25€



UNIÓN FLEXIBLE
NEGRO **CÓDIGO:** 62520
BLANCO **CÓDIGO:** 62521
PVP: 42,75€



CONECTOR AJUSTABLE
NEGRO **CÓDIGO:** 62522
BLANCO **CÓDIGO:** 62523
PVP: 34,95€



CONECTOR EN "X"
NEGRO **CÓDIGO:** 62524
BLANCO **CÓDIGO:** 62525
PVP: 57,25€



CONECTOR EN "L" REVERSIBLE (IZQ.-DER.)
NEGRO **CÓDIGO:** 62528
BLANCO **CÓDIGO:** 62529
PVP: 36,50€



CONECTOR EN "T" REVERSIBLE (IZQ. 1-IZQ. 2)
NEGRO **CÓDIGO:** 62530
BLANCO **CÓDIGO:** 62531
PVP: 47,35€

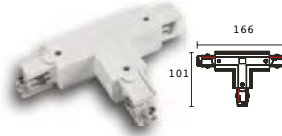

CONECTOR EN "T" REVERSIBLE (DER. 1-DER. 2)
NEGRO **CÓDIGO:** 62532
BLANCO **CÓDIGO:** 62533
PVP: 47,35€



CONECTOR EN "L" IZQUIERDA
NEGRO **CÓDIGO:** 62534
BLANCO **CÓDIGO:** 62535
PVP: 32,95€



CONECTOR EN "L" DERECHA
NEGRO **CÓDIGO:** 62536
BLANCO **CÓDIGO:** 62537
PVP: 32,95€



CONECTOR EN "T" IZQUIERDA
NEGRO **CÓDIGO:** 62538
BLANCO **CÓDIGO:** 62539
PVP: 49,50€



CONECTOR EN "T" IZQUIERDA 2
NEGRO **CÓDIGO:** 62540
BLANCO **CÓDIGO:** 62541
PVP: 49,50€



CONECTOR EN "T" DERECHA
NEGRO **CÓDIGO:** 62542
BLANCO **CÓDIGO:** 62543
PVP: 49,50€



CONECTOR EN "T" DERECHA 2
NEGRO **CÓDIGO:** 62544
BLANCO **CÓDIGO:** 62545
PVP: 49,50€



ENVELECEDOR CONECTOR "X"
NEGRO **CÓDIGO:** 62668
BLANCO **CÓDIGO:** 62669
PVP: 5,15€



TAPA UNIÓN INTERMEDIA
NEGRO **CÓDIGO:** 62670
BLANCO **CÓDIGO:** 62671
PVP: 4,50€



TAPA UNIÓN EN "L"
NEGRO **CÓDIGO:** 62672
BLANCO **CÓDIGO:** 62673
PVP: 4,30€



TAPA UNIÓN
NEGRO **CÓDIGO:** 62674
BLANCO **CÓDIGO:** 62675
PVP: 3,35€



TAPA UNIÓN EN "T"
NEGRO **CÓDIGO:** 62676
BLANCO **CÓDIGO:** 62677
PVP: 4,50€

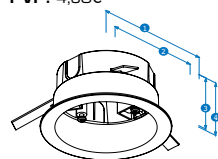

1. 130mm 2. 105mm 3. 58mm 4. 60mm
ADAPTADOR EMPOTRAR UNITARIO
NEGRO **CÓDIGO:** 62440
BLANCO **CÓDIGO:** 62441
PVP: 40,90€

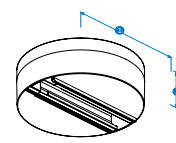

1. 100mm 2. 32mm
ADAPTADOR SUPERFICIE UNITARIO
NEGRO **CÓDIGO:** 62442
BLANCO **CÓDIGO:** 62443
PVP: 46,70€

TRACK SYSTEM TRIFÁSICO DALI

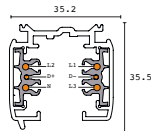

CARRIL TRIFÁSICO SUPERFICIE DE 1 METRO
NEGRO **CÓDIGO:** 62396
BLANCO **CÓDIGO:** 62397
PVP: 46,70€

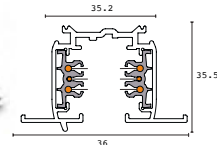

CARRIL TRIFÁSICO EMPOTRAR DE 1 METRO
NEGRO **CÓDIGO:** 62394
BLANCO **CÓDIGO:** 62395
PVP: 55,95€

CARRIL TRIFÁSICO SUPERFICIE DE 2 METROS
NEGRO **CÓDIGO:** 62404
BLANCO **CÓDIGO:** 62406
PVP: 93,15€

CARRIL TRIFÁSICO EMPOTRAR DE 2 METROS
NEGRO **CÓDIGO:** 62400
BLANCO **CÓDIGO:** 62402
PVP: 110,95€

ACCESORIOS

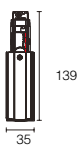

ALIMENTADOR TIERRA A IZQUIERDA
NEGRO **CÓDIGO:** 62410
BLANCO **CÓDIGO:** 62411
PVP: 18,95€

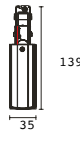

ALIMENTADOR TIERRA A DERECHA
NEGRO **CÓDIGO:** 62412
BLANCO **CÓDIGO:** 62413
PVP: 19,10€

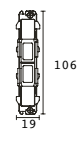

UNIÓN ELECTRICA
NEGRO **CÓDIGO:** 62414
BLANCO **CÓDIGO:** 62415
PVP: 13,50€

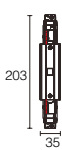

UNIÓN ELECTRICA CENTRAL
NEGRO **CÓDIGO:** 62418
BLANCO **CÓDIGO:** 62419
PVP: 38,95€



TAPA FINAL
NEGRO **CÓDIGO:** 62526
BLANCO **CÓDIGO:** 62527
PVP: 2,25€

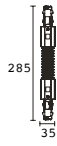

UNIÓN FLEXIBLE
NEGRO **CÓDIGO:** 62420
BLANCO **CÓDIGO:** 62421
PVP: 55,95€

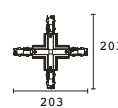

CONECTOR EN "X"
NEGRO **CÓDIGO:** 62530
BLANCO **CÓDIGO:** 62531
PVP: 86,85€

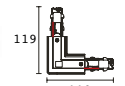

CONECTOR EN "L" TIERRA EXTERIOR
NEGRO **CÓDIGO:** 62424
BLANCO **CÓDIGO:** 62425
PVP: 47,75€



CONECTOR EN "L" TIERRA INTERIOR
NEGRO **CÓDIGO:** 62422
BLANCO **CÓDIGO:** 62423
PVP: 47,75€



CONECTOR EN "T" IZQUIERDA 1
NEGRO **CÓDIGO:** 62428
BLANCO **CÓDIGO:** 62429
PVP: 73,75€

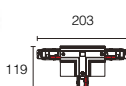

CONECTOR EN "T" IZQUIERDA 2
NEGRO **CÓDIGO:** 62478
BLANCO **CÓDIGO:** 62479
PVP: 73,75€

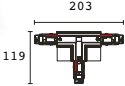

CONECTOR EN "T" DERECHA 1
NEGRO **CÓDIGO:** 62426
BLANCO **CÓDIGO:** 62427
PVP: 73,75€

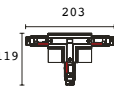

CONECTOR EN "T" DERECHA 2
NEGRO **CÓDIGO:** 62476
BLANCO **CÓDIGO:** 62477
PVP: 73,75€

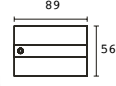

TAPA UNIÓN
NEGRO **CÓDIGO:** 62680
BLANCO **CÓDIGO:** 62681
PVP: 5,25€



TAPA UNIÓN EN "T"
NEGRO **CÓDIGO:** 62674
BLANCO **CÓDIGO:** 62675
PVP: 3,35€



TAPA UNIÓN EN "L"
NEGRO **CÓDIGO:** 62672
BLANCO **CÓDIGO:** 62673
PVP: 4,30€



TAPA UNIÓN EN "X"
NEGRO **CÓDIGO:** 62668
BLANCO **CÓDIGO:** 62669
PVP: 5,15€

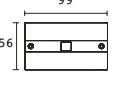

TAPA UNIÓN INTERMEDIA
NEGRO **CÓDIGO:** 62670
BLANCO **CÓDIGO:** 62671
PVP: 4,50€

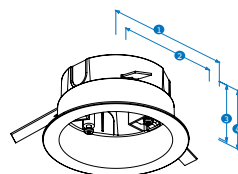

1. 130mm 2. 105mm 3. 58mm 4. 60mm

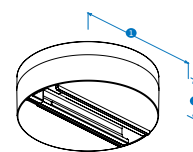

1. 100mm 2. 32mm

ADAPTADOR EMPOTRAR UNITARIO
NEGRO **CÓDIGO:** 62440
BLANCO **CÓDIGO:** 62441
PVP: 40,90€

ADAPTADOR SUPERFICIE UNITARIO
NEGRO **CÓDIGO:** 62442
BLANCO **CÓDIGO:** 62443
PVP: 46,70€

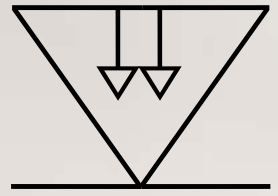

LYOPRO

LEVEL

ILUMINACIÓN DE INTERIOR EMPOTRADA
RECESSED INDOOR LIGHTING
ÉCLAIRAGE INTÉRIEUR ENCASTRÉ



Available in June

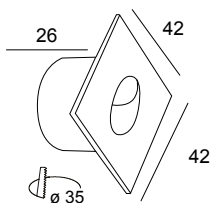
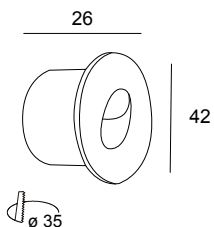
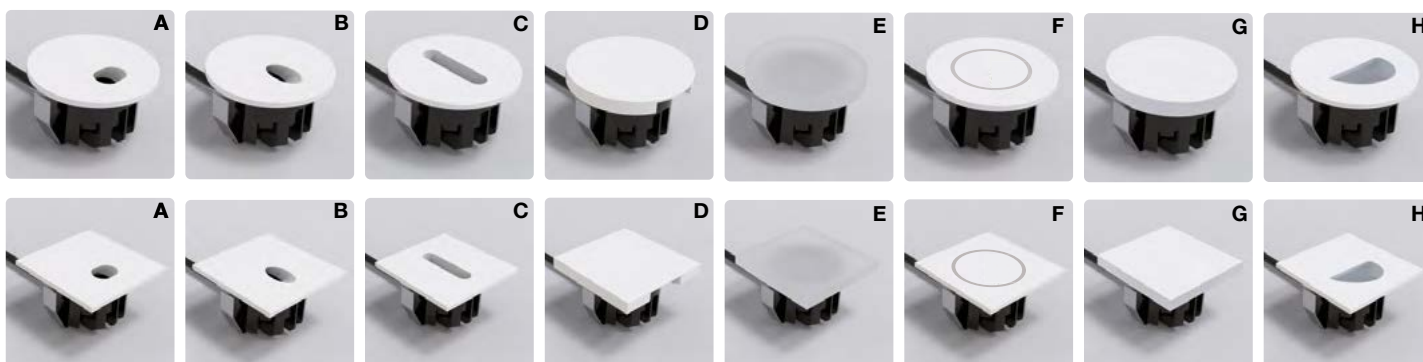

CÓDIGO	W	LM	K	TIPO	VERSIÓN		ELECTRÓNICA	PVP
62900	3w	240Lm	2700K	<u>A</u>	<u>R</u> Redondo	<u>B</u>	ON/OFF	19,95€
62901	3w	250Lm	3000K	<u>B</u>	<u>C</u> Cuadrado	<u>N</u>	ON/OFF	19,95€
62902	3w	260Lm	4000K	<u>C</u> <u>D</u> <u>F</u> <u>G</u> <u>H</u>				

CÓDIGO	W	LM	K	TIPO	VERSIÓN		ELECTRÓNICA	PVP
62900	3w	240Lm	2700K	<u>E</u>	<u>R</u> Redondo	<u>O</u> Opal	ON/OFF	19,95€
62901	3w	250Lm	3000K		<u>C</u> Cuadrado			
62902	3w	260Lm	4000K					

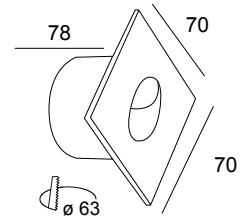
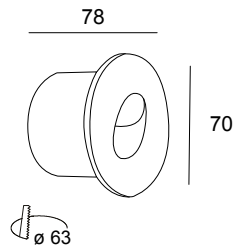

CÓDIGO	W	LM	K	VERSIÓN	ÓPTICA°	Ra/CRI			L	W	H		PVP
60200	3w	285Lm	3000K	Redondo	60	>80	-20+60	B <input type="checkbox"/>	70	78	63		42,90€
60201	3w	300Lm	4000K	Redondo	60	>80	-20+60	B <input type="checkbox"/>	70	78	63		42,90€
60203	3w	285Lm	3000K	Cuadrado	60	>80	-20+60	B <input type="checkbox"/>	70	70	78		42,90€
60204	3w	300Lm	4000K	Cuadrado	60	>80	-20+60	B <input type="checkbox"/>	70	70	78		42,90€





LYOPRO
LEVEL



**APLIQUES DE INTERIOR
INDOOR APPLIANCES
APPAREILS D'INTÉRIEUR**

NELLA

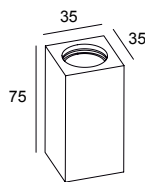

CÓDIGO	W	LM	K	ÓPTICA°	Ra/CRI			L	W	H	PVP
60800	2w	190Lm	3000K	60	>80	-20+50	B <input type="checkbox"/>	35	35	75	27,85€
60801	2w	200Lm	4000K	60	>80	-20+50	B <input type="checkbox"/>	35	35	75	27,85€

AZAI



1W



2x1W

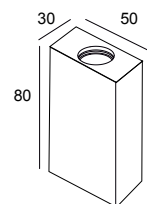
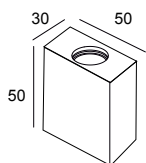

CÓDIGO	W	LM	K	ÓPTICA°	Ra/CRI			L	W	H	PVP
60803	1w	95Lm	3000K	60	>80	-20+50	B <input type="checkbox"/>	50	30	50	21,40€
60804	1w	100Lm	4000K	60	>80	-20+50	B <input type="checkbox"/>	50	30	50	21,40€
60806	2x1w	190Lm	3000K	60	>80	-20+50	B <input type="checkbox"/>	50	30	80	30,00€
60807	2x1w	200Lm	4000K	60	>80	-20+50	B <input type="checkbox"/>	50	30	80	30,00€

KERR

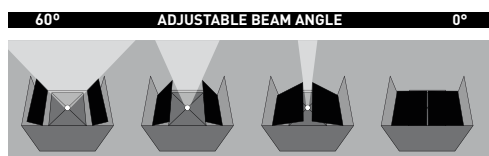
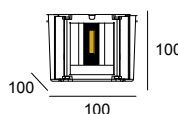

CÓDIGO	W	LM	K	ÓPTICA°	Ra/CRI			L	W	H	PVP
60848	6w	570Lm	3000K	0-60	>80	-20+60	B <input type="checkbox"/>	100	100	100	64,95€
60849	6w	600Lm	4000K	0-60	>80	-20+60	B <input type="checkbox"/>	100	100	100	64,95€

RHODA

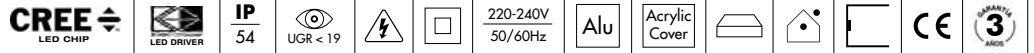

3W



2x3W

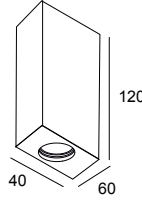
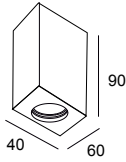

CÓDIGO	W	LM	K	ÓPTICA°	Ra/CRI	°C	Color	L	W	H	PVP
60833	3w	285Lm	3000K	60	>80	-20+60	A	40	60	90	53,65€
60834	3w	300Lm	4000K	60	>80	-20+60	A	40	60	90	53,65€
60839	2x3w	570Lm	3000K	60-60	>80	-20+60	A	40	60	120	64,40€
60840	2x3w	600Lm	4000K	60-60	>80	-20+60	A	40	60	120	64,40€

ADHAR

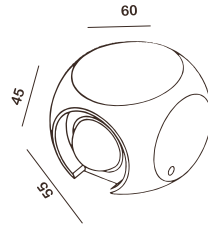

CÓDIGO	W	LM	K	ÓPTICA°	Ra/CRI	°C	Color	L	W	H	PVP
60869	2x1w	190Lm	3000K	60	>80	-20+60	B	55	45	60	36,95€
60870	2x1w	200Lm	4000K	60	>80	-20+60	B	55	45	60	36,95€

NARA

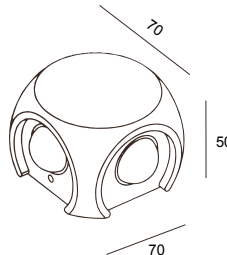

CÓDIGO	W	LM	K	ÓPTICA°	Ra/CRI	°C	Color	L	W	H	PVP
60872	4x1w	380Lm	3000K	60	>80	-20+60	B	70	50	70	39,95€
60873	4x1w	400Lm	4000K	60	>80	-20+60	B	70	50	70	39,95€

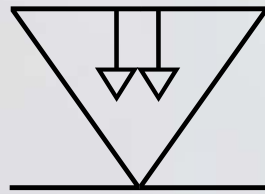
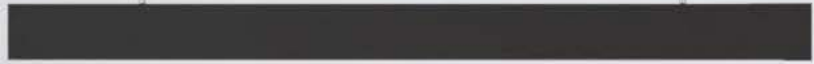
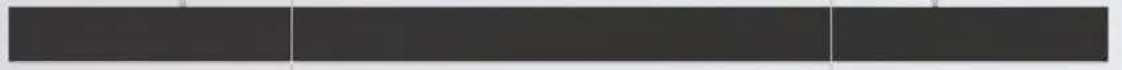

LYOPRO
LEVEL



LUMINARIA LINEAL
LINEAR LUMINAIRE
LUMINAIRE LINÉAIRE

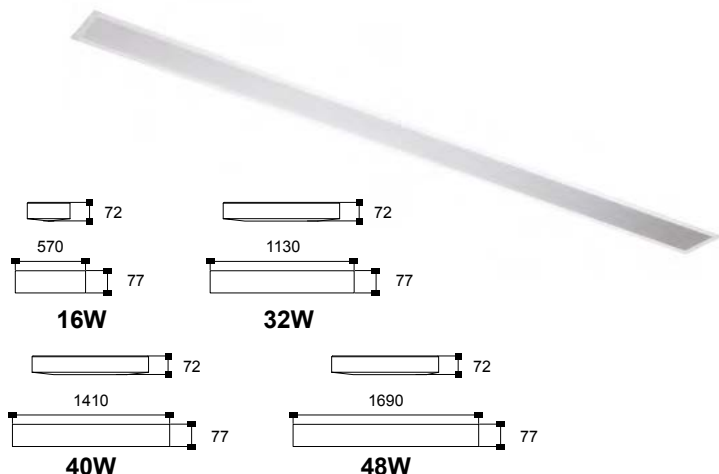

CÓDIGO	W	LM	K	ÓPTICA°	TEMP	VERSIÓN	MONTAJE	ELECTRÓNICA	DIMENSIONES			PVP
									L	W	H	
10383101077DD	16w	1520Lm	3000K	120	0+35	Empotrar	B	ON/OFF	570	77	72	183,48€
10383201077DD	16w	1520Lm	3000K	120	0+35	Empotrar	G	ON/OFF	570	77	72	187,59€
10383301077DD	16w	1520Lm	3000K	120	0+35	Empotrar	N	ON/OFF	570	77	72	203,30€
10383181077DD	16w	1520Lm	3000K	120	0+35	Empotrar	B	DALI	570	77	72	218,48€
10383281077DD	16w	3040Lm	3000K	120	0+35	Empotrar	G	DALI	570	77	72	222,74€
10383381077DD	16w	3040Lm	3000K	120	0+35	Empotrar	N	DALI	570	77	72	238,30€
10383102077DD	32w	3040Lm	3000K	120	0+35	Empotrar	B	ON/OFF	1130	77	72	222,78€
10383202077DD	32w	3040Lm	3000K	120	0+35	Empotrar	G	ON/OFF	1130	77	72	228,93€
10383302077DD	32w	3040Lm	3000K	120	0+35	Empotrar	N	ON/OFF	1130	77	72	242,59€
10383182077DD	32w	3040Lm	3000K	120	0+35	Empotrar	B	DALI	1130	77	72	282,44€
10383282077DD	32w	3800Lm	3000K	120	0+35	Empotrar	G	DALI	1130	77	72	288,89€
10383382077DD	32w	3800Lm	3000K	120	0+35	Empotrar	N	DALI	1130	77	72	302,26€
10383104177DD	40w	3800Lm	3000K	120	0+35	Empotrar	B	ON/OFF	1410	77	72	269,41€
10383204177DD	40w	3800Lm	3000K	120	0+35	Empotrar	G	ON/OFF	1410	77	72	277,63€
10383304177DD	40w	3800Lm	3000K	120	0+35	Empotrar	N	ON/OFF	1410	77	72	289,22€
10383184177DD	40w	3800Lm	3000K	120	0+35	Empotrar	B	DALI	1410	77	72	331,11€
10383284177DD	40w	4560Lm	3000K	120	0+35	Empotrar	G	DALI	1410	77	72	339,67€
10383384177DD	40w	4560Lm	3000K	120	0+35	Empotrar	N	DALI	1410	77	72	350,93€
10383103077DD	48w	4560Lm	3000K	120	0+35	Empotrar	B	ON/OFF	1690	77	72	277,96€
10383203077DD	48w	4560Lm	3000K	120	0+35	Empotrar	G	ON/OFF	1690	77	72	286,15€
10383303077DD	48w	4560Lm	3000K	120	0+35	Empotrar	N	ON/OFF	1690	77	72	297,78€
10383183077DD	48w	4560Lm	3000K	120	0+35	Empotrar	B	DALI	1690	77	72	340,04€
10383283077DD	48w	4560Lm	3000K	120	0+35	Empotrar	G	DALI	1690	77	72	348,59€
10383383077DD	48w	4560Lm	3000K	120	0+35	Empotrar	N	DALI	1690	77	72	359,85€
10384101077DD	16w	1520Lm	4000K	120	0+35	Empotrar	B	ON/OFF	570	77	72	183,48€
10384201077DD	16w	1520Lm	4000K	120	0+35	Empotrar	G	ON/OFF	570	77	72	187,59€
10384301077DD	16w	1520Lm	4000K	120	0+35	Empotrar	N	ON/OFF	570	77	72	203,30€
10384181077DD	16w	1520Lm	4000K	120	0+35	Empotrar	B	DALI	570	77	72	218,48€
10384281077DD	16w	3040Lm	4000K	120	0+35	Empotrar	G	DALI	570	77	72	222,74€
10384381077DD	16w	3040Lm	4000K	120	0+35	Empotrar	N	DALI	570	77	72	238,30€
10384102077DD	32w	3040Lm	4000K	120	0+35	Empotrar	B	ON/OFF	1130	77	72	222,78€
10384202077DD	32w	3040Lm	4000K	120	0+35	Empotrar	G	ON/OFF	1130	77	72	228,93€
10384302077DD	32w	3040Lm	4000K	120	0+35	Empotrar	N	ON/OFF	1130	77	72	242,59€
10384182077DD	32w	3040Lm	4000K	120	0+35	Empotrar	B	DALI	1130	77	72	282,44€
10384282077DD	32w	3800Lm	4000K	120	0+35	Empotrar	G	DALI	1130	77	72	288,89€
10384382077DD	32w	3800Lm	4000K	120	0+35	Empotrar	N	DALI	1130	77	72	302,26€
10384104177DD	40w	3800Lm	4000K	120	0+35	Empotrar	B	ON/OFF	1410	77	72	269,41€
10384204177DD	40w	3800Lm	4000K	120	0+35	Empotrar	G	ON/OFF	1410	77	72	277,63€
10384304177DD	40w	3800Lm	4000K	120	0+35	Empotrar	N	ON/OFF	1410	77	72	289,22€
10384184177DD	40w	3800Lm	4000K	120	0+35	Empotrar	B	DALI	1410	77	72	331,11€
10384284177DD	40w	4560Lm	4000K	120	0+35	Empotrar	G	DALI	1410	77	72	339,67€
10384384177DD	40w	4560Lm	4000K	120	0+35	Empotrar	N	DALI	1410	77	72	350,93€
10384103077DD	48w	4560Lm	4000K	120	0+35	Empotrar	B	ON/OFF	1690	77	72	277,96€
10384203077DD	48w	4560Lm	4000K	120	0+35	Empotrar	G	ON/OFF	1690	77	72	286,15€
10384303077DD	48w	4560Lm	4000K	120	0+35	Empotrar	N	ON/OFF	1690	77	72	297,78€
10384183077DD	48w	4560Lm	4000K	120	0+35	Empotrar	B	DALI	1690	77	72	340,04€
10384283077DD	48w	4560Lm	4000K	120	0+35	Empotrar	G	DALI	1690	77	72	348,59€
10384383077DD	48w	4560Lm	4000K	120	0+35	Empotrar	N	DALI	1690	77	72	359,85€

* Accesorios SIMA pag. 107

* Otras temperaturas de color a consultar.

* Otros acabados a consultar.

* Tapas y uniones sin cargo (para formar líneas continuas, indicar en el pedido: PRINCIPIO, INTERMEDIO, FINAL).

* Por defecto se suministrara en formato individual.

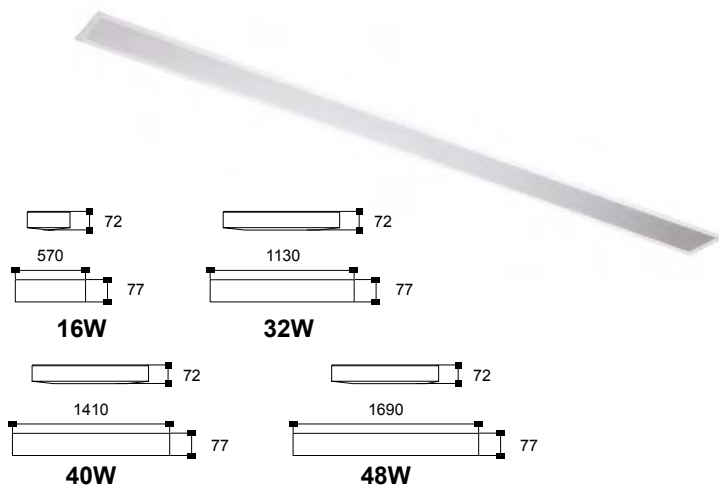

CÓDIGO	W	LM	K	ÓPTICA°		VERSIÓN		ELECTRÓNICA				PVP
									L	W	H	
10383101077DMP	16w	1680Lm	3000K	100	0+35	Empotrar	B	ON/OFF	570	77	72	191,67€
10383201077DMP	16w	1680Lm	3000K	100	0+35	Empotrar	G	ON/OFF	570	77	72	195,78€
10383301077DMP	16w	1680Lm	3000K	100	0+35	Empotrar	N	ON/OFF	570	77	72	211,48€
10383181077DMP	16w	1680Lm	3000K	100	0+35	Empotrar	B	DALI	570	77	72	227,04€
10383281077DMP	16w	1680Lm	3000K	100	0+35	Empotrar	G	DALI	570	77	72	231,30€
10383381077DMP	16w	1680Lm	3000K	100	0+35	Empotrar	N	DALI	570	77	72	246,85€
10383102077DMP	32w	3360Lm	3000K	100	0+35	Empotrar	B	ON/OFF	1130	77	72	239,19€
10383202077DMP	32w	3360Lm	3000K	100	0+35	Empotrar	G	ON/OFF	1130	77	72	245,33€
10383302077DMP	32w	3360Lm	3000K	100	0+35	Empotrar	N	ON/OFF	1130	77	72	259,00€
10383182077DMP	32w	3360Lm	3000K	100	0+35	Empotrar	B	DALI	1130	77	72	299,59€
10383282077DMP	32w	3360Lm	3000K	100	0+35	Empotrar	G	DALI	1130	77	72	306,00€
10383382077DMP	32w	3360Lm	3000K	100	0+35	Empotrar	N	DALI	1130	77	72	319,41€
10383104177DMP	40w	4200Lm	3000K	100	0+35	Empotrar	B	ON/OFF	1410	77	72	289,93€
10383204177DMP	40w	4200Lm	3000K	100	0+35	Empotrar	G	ON/OFF	1410	77	72	298,11€
10383304177DMP	40w	4200Lm	3000K	100	0+35	Empotrar	N	ON/OFF	1410	77	72	309,74€
10383184177DMP	40w	4200Lm	3000K	100	0+35	Empotrar	B	DALI	1410	77	72	352,52€
10383284177DMP	40w	4200Lm	3000K	100	0+35	Empotrar	G	DALI	1410	77	72	361,07€
10383384177DMP	40w	4200Lm	3000K	100	0+35	Empotrar	N	DALI	1410	77	72	372,33€
10383103077DMP	48w	5400Lm	3000K	100	0+35	Empotrar	B	ON/OFF	1690	77	72	302,56€
10383203077DMP	48w	5400Lm	3000K	100	0+35	Empotrar	G	ON/OFF	1690	77	72	310,78€
10383303077DMP	48w	5400Lm	3000K	100	0+35	Empotrar	N	ON/OFF	1690	77	72	322,37€
10383183077DMP	48w	5400Lm	3000K	100	0+35	Empotrar	B	DALI	1690	77	72	365,70€
10383283077DMP	48w	5400Lm	3000K	100	0+35	Empotrar	G	DALI	1690	77	72	375,67€
10383383077DMP	48w	5400Lm	3000K	100	0+35	Empotrar	N	DALI	1690	77	72	385,52€
10384101077DMP	16w	1680Lm	4000K	100	0+35	Empotrar	B	ON/OFF	570	77	72	191,67€
10384201077DMP	16w	1680Lm	4000K	100	0+35	Empotrar	G	ON/OFF	570	77	72	195,78€
10384301077DMP	16w	1680Lm	4000K	100	0+35	Empotrar	N	ON/OFF	570	77	72	211,48€
10384181077DMP	16w	1680Lm	4000K	100	0+35	Empotrar	B	DALI	570	77	72	227,04€
10384281077DMP	16w	1680Lm	4000K	100	0+35	Empotrar	G	DALI	570	77	72	231,30€
10384381077DMP	16w	1680Lm	4000K	100	0+35	Empotrar	N	DALI	570	77	72	246,85€
10384102077DMP	32w	3360Lm	4000K	100	0+35	Empotrar	B	ON/OFF	1130	77	72	239,19€
10384202077DMP	32w	3360Lm	4000K	100	0+35	Empotrar	G	ON/OFF	1130	77	72	245,33€
10384302077DMP	32w	3360Lm	4000K	100	0+35	Empotrar	N	ON/OFF	1130	77	72	259,00€
10384182077DMP	32w	3360Lm	4000K	100	0+35	Empotrar	B	DALI	1130	77	72	299,59€
10384282077DMP	32w	3360Lm	4000K	100	0+35	Empotrar	G	DALI	1130	77	72	306,00€
10384382077DMP	32w	3360Lm	4000K	100	0+35	Empotrar	N	DALI	1130	77	72	319,41€
10384104177DMP	40w	4200Lm	4000K	100	0+35	Empotrar	B	ON/OFF	1410	77	72	289,93€
10384204177DMP	40w	4200Lm	4000K	100	0+35	Empotrar	G	ON/OFF	1410	77	72	298,11€
10384304177DMP	40w	4200Lm	4000K	100	0+35	Empotrar	N	ON/OFF	1410	77	72	309,74€
10384184177DMP	40w	4200Lm	4000K	100	0+35	Empotrar	B	DALI	1410	77	72	352,52€
10384284177DMP	40w	4200Lm	4000K	100	0+35	Empotrar	G	DALI	1410	77	72	361,07€
10384384177DMP	40w	4200Lm	4000K	100	0+35	Empotrar	N	DALI	1410	77	72	372,33€
10384103077DMP	48w	5400Lm	4000K	100	0+35	Empotrar	B	ON/OFF	1690	77	72	302,56€
10384203077DMP	48w	5400Lm	4000K	100	0+35	Empotrar	G	ON/OFF	1690	77	72	310,78€
10384303077DMP	48w	5400Lm	4000K	100	0+35	Empotrar	N	ON/OFF	1690	77	72	322,37€
10384183077DMP	48w	5400Lm	4000K	100	0+35	Empotrar	B	DALI	1690	77	72	365,70€
10384283077DMP	48w	5400Lm	4000K	100	0+35	Empotrar	G	DALI	1690	77	72	375,67€
10384383077DMP	48w	5400Lm	4000K	100	0+35	Empotrar	N	DALI	1690	77	72	385,52€

* Accesorios SIMA pag. 107

* Otras temperaturas de color a consultar.

* Otros acabados a consultar.

* Tapas y uniones sin cargo (para formar líneas continuas, indicar en el pedido: PRINCIPIO, INTERMEDIO, FINAL).

* Por defecto se suministrará en formato individual.

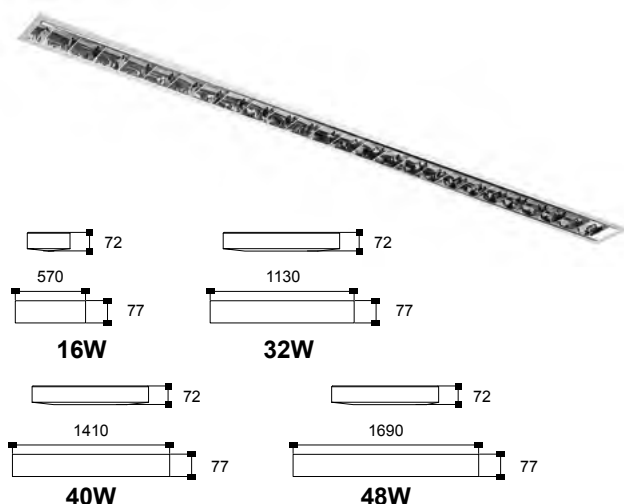

CÓDIGO	W	LM	K	ÓPTICA°		VERSIÓN		ELECTRÓNICA				PVP
									L	W	H	
10383101077COV	16w	1568Lm	3000K	90	0+35	Empotrar	B <input type="checkbox"/>	ON/OFF	570	77	72	228,59€
10383201077COV	16w	1568Lm	3000K	90	0+35	Empotrar	G <input checked="" type="checkbox"/>	ON/OFF	570	77	72	232,70€
10383301077COV	16w	1568Lm	3000K	90	0+35	Empotrar	N <input checked="" type="checkbox"/>	ON/OFF	570	77	72	248,41€
10383181077COV	16w	1568Lm	3000K	90	0+35	Empotrar	B <input type="checkbox"/>	DALI	570	77	72	265,56€
10383281077COV	16w	1568Lm	3000K	90	0+35	Empotrar	G <input checked="" type="checkbox"/>	DALI	570	77	72	269,81€
10383381077COV	16w	1568Lm	3000K	90	0+35	Empotrar	N <input checked="" type="checkbox"/>	DALI	570	77	72	285,37€
10383102077COV	32w	3136Lm	3000K	90	0+35	Empotrar	B <input type="checkbox"/>	ON/OFF	1130	77	72	267,89€
10383202077COV	32w	3136Lm	3000K	90	0+35	Empotrar	G <input checked="" type="checkbox"/>	ON/OFF	1130	77	72	274,04€
10383302077COV	32w	3136Lm	3000K	90	0+35	Empotrar	N <input checked="" type="checkbox"/>	ON/OFF	1130	77	72	287,70€
10383182077COV	32w	3136Lm	3000K	90	0+35	Empotrar	B <input type="checkbox"/>	DALI	1130	77	72	329,56€
10383282077COV	32w	3136Lm	3000K	90	0+35	Empotrar	G <input checked="" type="checkbox"/>	DALI	1130	77	72	335,96€
10383382077COV	32w	3136Lm	3000K	90	0+35	Empotrar	N <input checked="" type="checkbox"/>	DALI	1130	77	72	349,37€
10383104177COV	40w	3920Lm	3000K	90	0+35	Empotrar	B <input type="checkbox"/>	ON/OFF	1410	77	72	316,59€
10383204177COV	40w	3920Lm	3000K	90	0+35	Empotrar	G <input checked="" type="checkbox"/>	ON/OFF	1410	77	72	324,78€
10383304177COV	40w	3920Lm	3000K	90	0+35	Empotrar	N <input checked="" type="checkbox"/>	ON/OFF	1410	77	72	336,41€
10383184177COV	40w	3920Lm	3000K	90	0+35	Empotrar	B <input type="checkbox"/>	DALI	1410	77	72	380,33€
10383284177COV	40w	3920Lm	3000K	90	0+35	Empotrar	G <input checked="" type="checkbox"/>	DALI	1410	77	72	388,89€
10383384177COV	40w	3920Lm	3000K	90	0+35	Empotrar	N <input checked="" type="checkbox"/>	DALI	1410	77	72	400,15€
10383103077COV	48w	4704Lm	3000K	90	0+35	Empotrar	B <input type="checkbox"/>	ON/OFF	1690	77	72	341,52€
10383203077COV	48w	4704Lm	3000K	90	0+35	Empotrar	G <input checked="" type="checkbox"/>	ON/OFF	1690	77	72	349,74€
10383303077COV	48w	4704Lm	3000K	90	0+35	Empotrar	N <input checked="" type="checkbox"/>	ON/OFF	1690	77	72	361,33€
10383183077COV	48w	4704Lm	3000K	90	0+35	Empotrar	B <input type="checkbox"/>	DALI	1690	77	72	406,37€
10383283077COV	48w	4704Lm	3000K	90	0+35	Empotrar	G <input checked="" type="checkbox"/>	DALI	1690	77	72	414,93€
10383383077COV	48w	4704Lm	3000K	90	0+35	Empotrar	N <input checked="" type="checkbox"/>	DALI	1690	77	72	426,19€
10384101077COV	16w	1568Lm	4000K	90	0+35	Empotrar	B <input type="checkbox"/>	ON/OFF	570	77	72	228,59€
10384201077COV	16w	1568Lm	4000K	90	0+35	Empotrar	G <input checked="" type="checkbox"/>	ON/OFF	570	77	72	232,70€
10384301077COV	16w	1568Lm	4000K	90	0+35	Empotrar	N <input checked="" type="checkbox"/>	ON/OFF	570	77	72	248,41€
10384181077COV	16w	1568Lm	4000K	90	0+35	Empotrar	B <input type="checkbox"/>	DALI	570	77	72	265,56€
10384281077COV	16w	1568Lm	4000K	90	0+35	Empotrar	G <input checked="" type="checkbox"/>	DALI	570	77	72	269,81€
10384381077COV	16w	1568Lm	4000K	90	0+35	Empotrar	N <input checked="" type="checkbox"/>	DALI	570	77	72	285,37€
10384102077COV	32w	3136Lm	4000K	90	0+35	Empotrar	B <input type="checkbox"/>	ON/OFF	1130	77	72	267,89€
10384202077COV	32w	3136Lm	4000K	90	0+35	Empotrar	G <input checked="" type="checkbox"/>	ON/OFF	1130	77	72	274,04€
10384302077COV	32w	3136Lm	4000K	90	0+35	Empotrar	N <input checked="" type="checkbox"/>	ON/OFF	1130	77	72	287,70€
10384182077COV	32w	3136Lm	4000K	90	0+35	Empotrar	B <input type="checkbox"/>	DALI	1130	77	72	329,56€
10384282077COV	32w	3136Lm	4000K	90	0+35	Empotrar	G <input checked="" type="checkbox"/>	DALI	1130	77	72	335,96€
10384382077COV	32w	3136Lm	4000K	90	0+35	Empotrar	N <input checked="" type="checkbox"/>	DALI	1130	77	72	349,37€
10384104177COV	40w	3920Lm	4000K	90	0+35	Empotrar	B <input type="checkbox"/>	ON/OFF	1410	77	72	316,59€
10384204177COV	40w	3920Lm	4000K	90	0+35	Empotrar	G <input checked="" type="checkbox"/>	ON/OFF	1410	77	72	324,78€
10384304177COV	40w	3920Lm	4000K	90	0+35	Empotrar	N <input checked="" type="checkbox"/>	ON/OFF	1410	77	72	336,41€
10384184177COV	40w	3920Lm	4000K	90	0+35	Empotrar	B <input type="checkbox"/>	DALI	1410	77	72	380,33€
10384284177COV	40w	3920Lm	4000K	90	0+35	Empotrar	G <input checked="" type="checkbox"/>	DALI	1410	77	72	388,89€
10384384177COV	40w	3920Lm	4000K	90	0+35	Empotrar	N <input checked="" type="checkbox"/>	DALI	1410	77	72	400,15€
10384103077COV	48w	4704Lm	4000K	90	0+35	Empotrar	B <input type="checkbox"/>	ON/OFF	1690	77	72	341,52€
10384203077COV	48w	4704Lm	4000K	90	0+35	Empotrar	G <input checked="" type="checkbox"/>	ON/OFF	1690	77	72	349,74€
10384303077COV	48w	4704Lm	4000K	90	0+35	Empotrar	N <input checked="" type="checkbox"/>	ON/OFF	1690	77	72	361,33€
10384183077COV	48w	4704Lm	4000K	90	0+35	Empotrar	B <input type="checkbox"/>	DALI	1690	77	72	406,37€
10384283077COV	48w	4704Lm	4000K	90	0+35	Empotrar	G <input checked="" type="checkbox"/>	DALI	1690	77	72	414,93€
10384383077COV	48w	4704Lm	4000K	90	0+35	Empotrar	N <input checked="" type="checkbox"/>	DALI	1690	77	72	426,19€

* Accesorios SIMA pag. 107

* Otras temperaturas de color a consultar.

* Otros acabados a consultar.

* Tapas y uniones sin cargo (para formar líneas continuas, indicar en el pedido: PRINCIPIO, INTERMEDIO, FINAL).

* Por defecto se suministrara en formato individual.

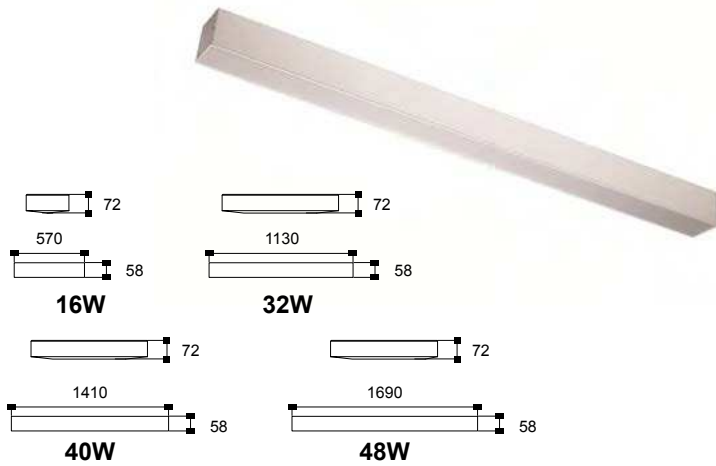

CÓDIGO	W	LM	K	ÓPTICA°		VERSIÓN		ELECTRÓNICA				PVP
									L	W	H	
10383101085D0	16w	1520Lm	3000K	120	0+35	Superficie	B <input type="checkbox"/>	ON/OFF	570	58	72	162,96€
10383201085D0	16w	1520Lm	3000K	120	0+35	Superficie	G <input type="checkbox"/>	ON/OFF	570	58	72	167,07€
10383301085D0	16w	1520Lm	3000K	120	0+35	Superficie	N <input type="checkbox"/>	ON/OFF	570	58	72	182,78€
10383181085D0	16w	1520Lm	3000K	120	0+35	Superficie	B <input type="checkbox"/>	DALI	570	58	72	197,07€
10383281085D0	16w	3040Lm	3000K	120	0+35	Superficie	G <input type="checkbox"/>	DALI	570	58	72	201,33€
10383381085D0	16w	3040Lm	3000K	120	0+35	Superficie	N <input type="checkbox"/>	DALI	570	58	72	216,89€
10383102085D0	32w	3040Lm	3000K	120	0+35	Superficie	B <input type="checkbox"/>	ON/OFF	1130	58	72	202,26€
10383202085D0	32w	3040Lm	3000K	120	0+35	Superficie	G <input type="checkbox"/>	ON/OFF	1130	58	72	208,41€
10383302085D0	32w	3040Lm	3000K	120	0+35	Superficie	N <input type="checkbox"/>	ON/OFF	1130	58	72	222,07€
10383182085D0	32w	3040Lm	3000K	120	0+35	Superficie	B <input type="checkbox"/>	DALI	1130	58	72	261,04€
10383282085D0	32w	3800Lm	3000K	120	0+35	Superficie	G <input type="checkbox"/>	DALI	1130	58	72	267,48€
10383382085D0	32w	3800Lm	3000K	120	0+35	Superficie	N <input type="checkbox"/>	DALI	1130	58	72	280,89€
10383104185D0	40w	3800Lm	3000K	120	0+35	Superficie	B <input type="checkbox"/>	ON/OFF	1410	58	72	248,89€
10383204185D0	40w	3800Lm	3000K	120	0+35	Superficie	G <input type="checkbox"/>	ON/OFF	1410	58	72	257,11€
10383304185D0	40w	3800Lm	3000K	120	0+35	Superficie	N <input type="checkbox"/>	ON/OFF	1410	58	72	268,70€
10383184185D0	40w	3800Lm	3000K	120	0+35	Superficie	B <input type="checkbox"/>	DALI	1410	58	72	309,70€
10383284185D0	40w	4560Lm	3000K	120	0+35	Superficie	G <input type="checkbox"/>	DALI	1410	58	72	318,30€
10383384185D0	40w	4560Lm	3000K	120	0+35	Superficie	N <input type="checkbox"/>	DALI	1410	58	72	329,56€
10383103085D0	48w	4560Lm	3000K	120	0+35	Superficie	B <input type="checkbox"/>	ON/OFF	1690	58	72	257,44€
10383203085D0	48w	4560Lm	3000K	120	0+35	Superficie	G <input type="checkbox"/>	ON/OFF	1690	58	72	265,63€
10383303085D0	48w	4560Lm	3000K	120	0+35	Superficie	N <input type="checkbox"/>	ON/OFF	1690	58	72	277,26€
10383183085D0	48w	4560Lm	3000K	120	0+35	Superficie	B <input type="checkbox"/>	DALI	1690	58	72	318,63€
10383283085D0	48w	4560Lm	3000K	120	0+35	Superficie	G <input type="checkbox"/>	DALI	1690	58	72	327,19€
10383383085D0	48w	4560Lm	3000K	120	0+35	Superficie	N <input type="checkbox"/>	DALI	1690	58	72	338,44€
10384101085D0	16w	1520Lm	4000K	120	0+35	Superficie	B <input type="checkbox"/>	ON/OFF	570	58	72	162,96€
10384201085D0	16w	1520Lm	4000K	120	0+35	Superficie	G <input type="checkbox"/>	ON/OFF	570	58	72	167,07€
10384301085D0	16w	1520Lm	4000K	120	0+35	Superficie	N <input type="checkbox"/>	ON/OFF	570	58	72	182,78€
10384181085D0	16w	1520Lm	4000K	120	0+35	Superficie	B <input type="checkbox"/>	DALI	570	58	72	197,07€
10384281085D0	16w	3040Lm	4000K	120	0+35	Superficie	G <input type="checkbox"/>	DALI	570	58	72	201,33€
10384381085D0	16w	3040Lm	4000K	120	0+35	Superficie	N <input type="checkbox"/>	DALI	570	58	72	216,89€
10384102085D0	32w	3040Lm	4000K	120	0+35	Superficie	B <input type="checkbox"/>	ON/OFF	1130	58	72	202,26€
10384202085D0	32w	3040Lm	4000K	120	0+35	Superficie	G <input type="checkbox"/>	ON/OFF	1130	58	72	208,41€
10384302085D0	32w	3040Lm	4000K	120	0+35	Superficie	N <input type="checkbox"/>	ON/OFF	1130	58	72	222,07€
10384182085D0	32w	3040Lm	4000K	120	0+35	Superficie	B <input type="checkbox"/>	DALI	1130	58	72	261,04€
10384282085D0	32w	3800Lm	4000K	120	0+35	Superficie	G <input type="checkbox"/>	DALI	1130	58	72	267,48€
10384382085D0	32w	3800Lm	4000K	120	0+35	Superficie	N <input type="checkbox"/>	DALI	1130	58	72	280,89€
10384104185D0	40w	3800Lm	4000K	120	0+35	Superficie	B <input type="checkbox"/>	ON/OFF	1410	58	72	248,89€
10384204185D0	40w	3800Lm	4000K	120	0+35	Superficie	G <input type="checkbox"/>	ON/OFF	1410	58	72	257,11€
10384304185D0	40w	3800Lm	4000K	120	0+35	Superficie	N <input type="checkbox"/>	ON/OFF	1410	58	72	268,70€
10384184185D0	40w	3800Lm	4000K	120	0+35	Superficie	B <input type="checkbox"/>	DALI	1410	58	72	309,70€
10384284185D0	40w	4560Lm	4000K	120	0+35	Superficie	G <input type="checkbox"/>	DALI	1410	58	72	318,30€
10384384185D0	40w	4560Lm	4000K	120	0+35	Superficie	N <input type="checkbox"/>	DALI	1410	58	72	329,56€
10384103085D0	48w	4560Lm	4000K	120	0+35	Superficie	B <input type="checkbox"/>	ON/OFF	1690	58	72	257,44€
10384203085D0	48w	4560Lm	4000K	120	0+35	Superficie	G <input type="checkbox"/>	ON/OFF	1690	58	72	265,63€
10384303085D0	48w	4560Lm	4000K	120	0+35	Superficie	N <input type="checkbox"/>	ON/OFF	1690	58	72	277,26€
10384183085D0	48w	4560Lm	4000K	120	0+35	Superficie	B <input type="checkbox"/>	DALI	1690	58	72	318,63€
10384283085D0	48w	4560Lm	4000K	120	0+35	Superficie	G <input type="checkbox"/>	DALI	1690	58	72	327,19€
10384383085D0	48w	4560Lm	4000K	120	0+35	Superficie	N <input type="checkbox"/>	DALI	1690	58	72	338,44€

*Accesorios SIMA pag. 107

*Otras temperaturas de color a consultar.

*Otros acabados a consultar.

*Tapas y uniones sin cargo (para formar líneas continuas, indicar en el pedido: PRINCIPIO, INTERMEDIO, FINAL).

*Por defecto se suministrara en formato individual.

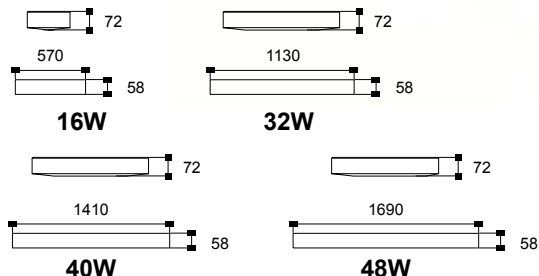

CÓDIGO	W	LM	K	ÓPTICA°		VERSIÓN		ELECTRÓNICA				PVP
									L	W	H	
10383101085DMP	16w	1680Lm	3000K	100	0+35	Superficie	B	ON/OFF	570	58	72	171,19€
10383201085DMP	16w	1680Lm	3000K	100	0+35	Superficie	G	ON/OFF	570	58	72	175,26€
10383301085DMP	16w	1680Lm	3000K	100	0+35	Superficie	N	ON/OFF	570	58	72	191,00€
10383181085DMP	16w	1680Lm	3000K	100	0+35	Superficie	B	DALI	570	58	72	205,63€
10383281085DMP	16w	1680Lm	3000K	100	0+35	Superficie	G	DALI	570	58	72	209,89€
10383381085DMP	16w	1680Lm	3000K	100	0+35	Superficie	N	DALI	570	58	72	225,44€
10383102085DMP	32w	3360Lm	3000K	100	0+35	Superficie	B	ON/OFF	1130	58	72	218,67€
10383202085DMP	32w	3360Lm	3000K	100	0+35	Superficie	G	ON/OFF	1130	58	72	224,81€
10383302085DMP	32w	3360Lm	3000K	100	0+35	Superficie	N	ON/OFF	1130	58	72	238,48€
10383182085DMP	32w	3360Lm	3000K	100	0+35	Superficie	B	DALI	1130	58	72	278,19€
10383282085DMP	32w	3360Lm	3000K	100	0+35	Superficie	G	DALI	1130	58	72	284,59€
10383382085DMP	32w	3360Lm	3000K	100	0+35	Superficie	N	DALI	1130	58	72	298,00€
10383104185DMP	40w	4200Lm	3000K	100	0+35	Superficie	B	ON/OFF	1410	58	72	269,41€
10383204185DMP	40w	4200Lm	3000K	100	0+35	Superficie	G	ON/OFF	1410	58	72	277,63€
10383304185DMP	40w	4200Lm	3000K	100	0+35	Superficie	N	ON/OFF	1410	58	72	289,22€
10383184185DMP	40w	4200Lm	3000K	100	0+35	Superficie	B	DALI	1410	58	72	331,11€
10383284185DMP	40w	4200Lm	3000K	100	0+35	Superficie	G	DALI	1410	58	72	339,67€
10383384185DMP	40w	4200Lm	3000K	100	0+35	Superficie	N	DALI	1410	58	72	350,93€
10383103085DMP	48w	5400Lm	3000K	100	0+35	Superficie	B	ON/OFF	1690	58	72	282,04€
10383203085DMP	48w	5400Lm	3000K	100	0+35	Superficie	G	ON/OFF	1690	58	72	290,26€
10383303085DMP	48w	5400Lm	3000K	100	0+35	Superficie	N	ON/OFF	1690	58	72	301,85€
10383183085DMP	48w	5400Lm	3000K	100	0+35	Superficie	B	DALI	1690	58	72	344,30€
10383283085DMP	48w	5400Lm	3000K	100	0+35	Superficie	G	DALI	1690	58	72	352,85€
10383383085DMP	48w	5400Lm	3000K	100	0+35	Superficie	N	DALI	1690	58	72	364,11€
10384101085DMP	16w	1680Lm	4000K	100	0+35	Superficie	B	ON/OFF	570	58	72	171,19€
10384201085DMP	16w	1680Lm	4000K	100	0+35	Superficie	G	ON/OFF	570	58	72	175,26€
10384301085DMP	16w	1680Lm	4000K	100	0+35	Superficie	N	ON/OFF	570	58	72	191,00€
10384181085DMP	16w	1680Lm	4000K	100	0+35	Superficie	B	DALI	570	58	72	205,63€
10384281085DMP	16w	1680Lm	4000K	100	0+35	Superficie	G	DALI	570	58	72	209,89€
10384381085DMP	16w	1680Lm	4000K	100	0+35	Superficie	N	DALI	570	58	72	225,44€
10384102085DMP	32w	3360Lm	4000K	100	0+35	Superficie	B	ON/OFF	1130	58	72	218,67€
10384202085DMP	32w	3360Lm	4000K	100	0+35	Superficie	G	ON/OFF	1130	58	72	224,81€
10384302085DMP	32w	3360Lm	4000K	100	0+35	Superficie	N	ON/OFF	1130	58	72	238,48€
10384182085DMP	32w	3360Lm	4000K	100	0+35	Superficie	B	DALI	1130	58	72	278,19€
10384282085DMP	32w	3360Lm	4000K	100	0+35	Superficie	G	DALI	1130	58	72	284,59€
10384382085DMP	32w	3360Lm	4000K	100	0+35	Superficie	N	DALI	1130	58	72	298,00€
10384104185DMP	40w	4200Lm	4000K	100	0+35	Superficie	B	ON/OFF	1410	58	72	269,41€
10384204185DMP	40w	4200Lm	4000K	100	0+35	Superficie	G	ON/OFF	1410	58	72	277,63€
10384304185DMP	40w	4200Lm	4000K	100	0+35	Superficie	N	ON/OFF	1410	58	72	289,22€
10384184185DMP	40w	4200Lm	4000K	100	0+35	Superficie	B	DALI	1410	58	72	331,11€
10384284185DMP	40w	4200Lm	4000K	100	0+35	Superficie	G	DALI	1410	58	72	339,67€
10384384185DMP	40w	4200Lm	4000K	100	0+35	Superficie	N	DALI	1410	58	72	350,93€
10384103085DMP	48w	5400Lm	4000K	100	0+35	Superficie	B	ON/OFF	1690	58	72	282,04€
10384203085DMP	48w	5400Lm	4000K	100	0+35	Superficie	G	ON/OFF	1690	58	72	290,26€
10384303085DMP	48w	5400Lm	4000K	100	0+35	Superficie	N	ON/OFF	1690	58	72	301,85€
10384183085DMP	48w	5400Lm	4000K	100	0+35	Superficie	B	DALI	1690	58	72	344,30€
10384283085DMP	48w	5400Lm	4000K	100	0+35	Superficie	G	DALI	1690	58	72	352,85€
10384383085DMP	48w	5400Lm	4000K	100	0+35	Superficie	N	DALI	1690	58	72	364,11€

* Accesorios SIMA pag. 107

* Otras temperaturas de color a consultar.

* Otros acabados a consultar.

* Tapas y uniones sin cargo (para formar líneas continuas, indicar en el pedido: PRINCIPIO, INTERMEDIO, FINAL).

* Por defecto se suministrara en formato individual.

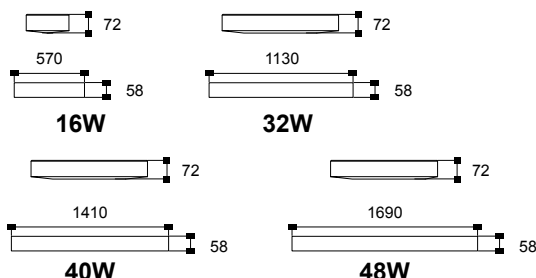

CÓDIGO	W	LM	K	ÓPTICA°		VERSIÓN		ELECTRÓNICA				PVP
									L	W	H	
10383101085COV	16w	1568Lm	3000K	90	0+35	Superficie	B	ON/OFF	570	58	72	208,07€
10383201085COV	16w	1568Lm	3000K	90	0+35	Superficie	G	ON/OFF	570	58	72	212,19€
10383301085COV	16w	1568Lm	3000K	90	0+35	Superficie	N	ON/OFF	570	58	72	227,93€
10383181085COV	16w	1568Lm	3000K	90	0+35	Superficie	B	DALI	570	58	72	244,15€
10383281085COV	16w	1568Lm	3000K	90	0+35	Superficie	G	DALI	570	58	72	248,44€
10383381085COV	16w	1568Lm	3000K	90	0+35	Superficie	N	DALI	570	58	72	263,96€
10383102085COV	32w	3136Lm	3000K	90	0+35	Superficie	B	ON/OFF	1130	58	72	247,37€
10383202085COV	32w	3136Lm	3000K	90	0+35	Superficie	G	ON/OFF	1130	58	72	253,56€
10383302085COV	32w	3136Lm	3000K	90	0+35	Superficie	N	ON/OFF	1130	58	72	267,22€
10383182085COV	32w	3136Lm	3000K	90	0+35	Superficie	B	DALI	1130	58	72	306,63€
10383282085COV	32w	3136Lm	3000K	90	0+35	Superficie	G	DALI	1130	58	72	314,56€
10383382085COV	32w	3136Lm	3000K	90	0+35	Superficie	N	DALI	1130	58	72	319,04€
10383104185COV	40w	3920Lm	3000K	90	0+35	Superficie	B	ON/OFF	1410	58	72	296,07€
10383204185COV	40w	3920Lm	3000K	90	0+35	Superficie	G	ON/OFF	1410	58	72	304,30€
10383304185COV	40w	3920Lm	3000K	90	0+35	Superficie	N	ON/OFF	1410	58	72	315,89€
10383184185COV	40w	3920Lm	3000K	90	0+35	Superficie	B	DALI	1410	58	72	358,96€
10383284185COV	40w	3920Lm	3000K	90	0+35	Superficie	G	DALI	1410	58	72	367,52€
10383384185COV	40w	3920Lm	3000K	90	0+35	Superficie	N	DALI	1410	58	72	378,78€
10383103085COV	48w	4704Lm	3000K	90	0+35	Superficie	B	ON/OFF	1690	58	72	321,00€
10383203085COV	48w	4704Lm	3000K	90	0+35	Superficie	G	ON/OFF	1690	58	72	329,22€
10383303085COV	48w	4704Lm	3000K	90	0+35	Superficie	N	ON/OFF	1690	58	72	340,85€
10383183085COV	48w	4704Lm	3000K	90	0+35	Superficie	B	DALI	1690	58	72	384,96€
10383283085COV	48w	4704Lm	3000K	90	0+35	Superficie	G	DALI	1690	58	72	393,52€
10383383085COV	48w	4704Lm	3000K	90	0+35	Superficie	N	DALI	1690	58	72	404,78€
10384101085COV	16w	1568Lm	4000K	90	0+35	Superficie	B	ON/OFF	570	58	72	208,07€
10384201085COV	16w	1568Lm	4000K	90	0+35	Superficie	G	ON/OFF	570	58	72	212,19€
10384301085COV	16w	1568Lm	4000K	90	0+35	Superficie	N	ON/OFF	570	58	72	227,93€
10384181085COV	16w	1568Lm	4000K	90	0+35	Superficie	B	DALI	570	58	72	244,15€
10384281085COV	16w	1568Lm	4000K	90	0+35	Superficie	G	DALI	570	58	72	248,44€
10384381085COV	16w	1568Lm	4000K	90	0+35	Superficie	N	DALI	570	58	72	263,96€
10384102085COV	32w	3136Lm	4000K	90	0+35	Superficie	B	ON/OFF	1130	58	72	247,37€
10384202085COV	32w	3136Lm	4000K	90	0+35	Superficie	G	ON/OFF	1130	58	72	253,56€
10384302085COV	32w	3136Lm	4000K	90	0+35	Superficie	N	ON/OFF	1130	58	72	267,22€
10384182085COV	32w	3136Lm	4000K	90	0+35	Superficie	B	DALI	1130	58	72	306,63€
10384282085COV	32w	3136Lm	4000K	90	0+35	Superficie	G	DALI	1130	58	72	314,56€
10384382085COV	32w	3136Lm	4000K	90	0+35	Superficie	N	DALI	1130	58	72	319,04€
10384104185COV	40w	3920Lm	4000K	90	0+35	Superficie	B	ON/OFF	1410	58	72	296,07€
10384204185COV	40w	3920Lm	4000K	90	0+35	Superficie	G	ON/OFF	1410	58	72	304,30€
10384304185COV	40w	3920Lm	4000K	90	0+35	Superficie	N	ON/OFF	1410	58	72	315,89€
10384184185COV	40w	3920Lm	4000K	90	0+35	Superficie	B	DALI	1410	58	72	358,96€
10384284185COV	40w	3920Lm	4000K	90	0+35	Superficie	G	DALI	1410	58	72	367,52€
10384384185COV	40w	3920Lm	4000K	90	0+35	Superficie	N	DALI	1410	58	72	378,78€
10384103085COV	48w	4704Lm	4000K	90	0+35	Superficie	B	ON/OFF	1690	58	72	321,00€
10384203085COV	48w	4704Lm	4000K	90	0+35	Superficie	G	ON/OFF	1690	58	72	329,22€
10384303085COV	48w	4704Lm	4000K	90	0+35	Superficie	N	ON/OFF	1690	58	72	340,85€
10384183085COV	48w	4704Lm	4000K	90	0+35	Superficie	B	DALI	1690	58	72	384,96€
10384283085COV	48w	4704Lm	4000K	90	0+35	Superficie	G	DALI	1690	58	72	393,52€
10384383085COV	48w	4704Lm	4000K	90	0+35	Superficie	N	DALI	1690	58	72	404,78€

* Accesorios SIMA pag. 107

* Otras temperaturas de color a consultar.

* Otros acabados a consultar.

* Tapas y uniones sin cargo (para formar líneas continuas, indicar en el pedido: PRINCIPIO, INTERMEDIO, FINAL).

* Por defecto se suministrara en formato individual.

ACCESORIOS **SIMA** EMPOTRAR

CÓDIGO	DESCRIPCIÓN	PVP
1038COD09058	ÁNGULO 90° SIMA EMPOTRAR	82,22€
1038315MM58	PRECABLEADO 3X1,5MM2 SIMA EMPOTRAR	39,63€
1038515MM58	PRECABLEADO 5X1,5MM2 SIMA EMPOTRAR	74,30€
1038KE1H	KIT EMERGENCIA 1HORA	222,93€

ACCESORIOS **SIMA** SUPERFICIE

CÓDIGO	DESCRIPCIÓN	PVP
1038KS1M58	KIT SUSPENSIÓN SIMA 1M	44,59€
1038COD09077	ÁNGULO 90° SIMA SUP	82,22€
1038315MM77	PRECABLEADO 3X1,5MM2 SIMA SUP	39,63€
1038515MM77	PRECABLEADO 5X1,5MM2 SIMA SUP	74,30€
1038KE1H	KIT EMERGENCIA 1HORA	222,93€
1038KBM	KIT BRAZO MURAL	59,44€
1038TRIM	SISTEMA TRIMLESS SIMA	49,56€

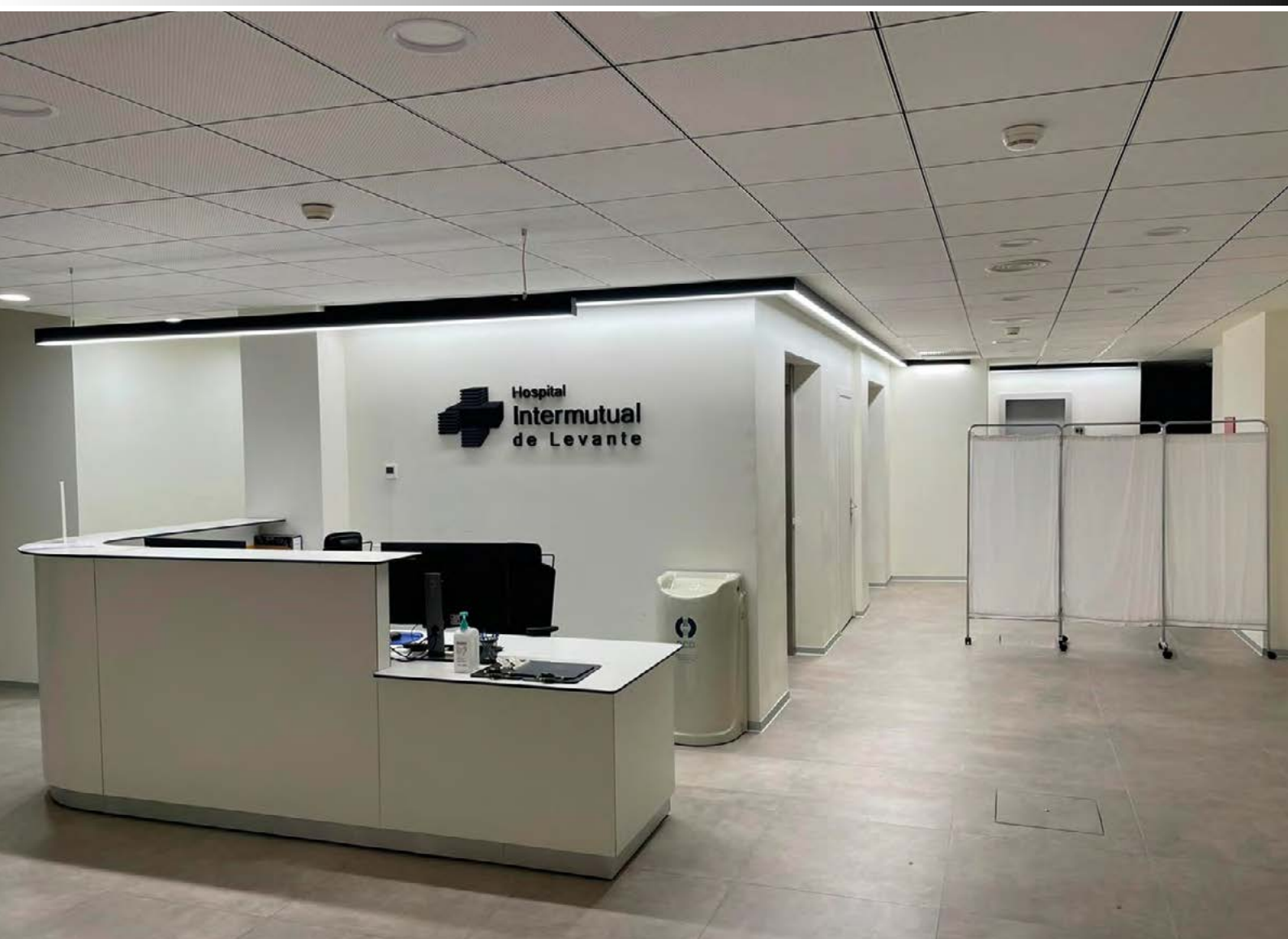

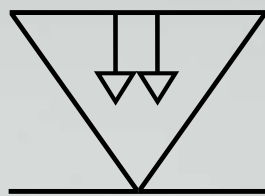

LYOPRO
LEVEL

LUMINARIAS DE EMPOTRAR-SUPERFICIE
RECESSED-SURFACE LUMINAIRES
LUMINAIRES DE ENCASTRÉ-SURFACE

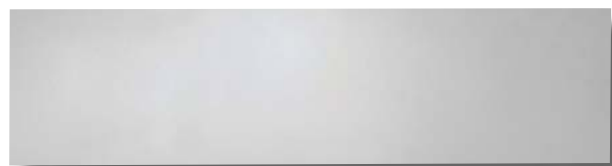

CÓDIGO	W	LM	K	ÓPTICA°	Ra/CRI			L	W	ELECTRÓNICA	PVP
20340	36w	3600Lm	4000K	120	>80	-20+40	B <input type="checkbox"/>	600	600	On/Off	49,95€
20342	36w	3600Lm	4000K	120	>80	-20+40	B <input type="checkbox"/>	1200	300	On/Off	59,95€
20344	72w	7200Lm	4000K	120	>80	-20+40	B <input type="checkbox"/>	1200	600	On/Off	129,95€
20340A	36w	3600Lm	4000K	120	>80	-20+40	B <input type="checkbox"/>	600	600	Triac	69,95€
20342A	36w	3600Lm	4000K	120	>80	-20+40	B <input type="checkbox"/>	1200	300	Triac	79,95€
20344A	72w	7200Lm	4000K	120	>80	-20+40	B <input type="checkbox"/>	1200	600	Triac	149,95€
20340B	36w	3600Lm	4000K	120	>80	-20+40	B <input type="checkbox"/>	600	600	1-10v	72,95€
20342B	36w	3600Lm	4000K	120	>80	-20+40	B <input type="checkbox"/>	1200	300	1-10v	82,95€
20344B	72w	7200Lm	4000K	120	>80	-20+40	B <input type="checkbox"/>	1200	600	1-10v	152,95€
20340C	36w	3600Lm	4000K	120	>80	-20+40	B <input type="checkbox"/>	600	600	Dali/Push	92,95€
20342C	36w	3600Lm	4000K	120	>80	-20+40	B <input type="checkbox"/>	1200	300	Dali/Push	102,95€
20344C	72w	7200Lm	4000K	120	>80	-20+40	B <input type="checkbox"/>	1200	600	Dali/Push	182,95€

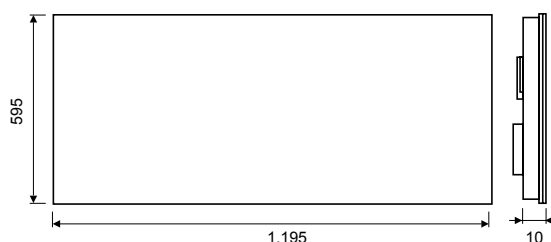
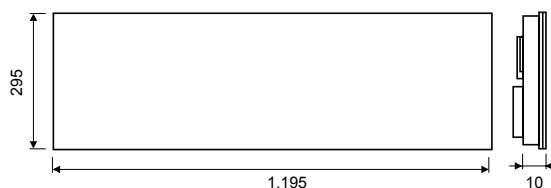
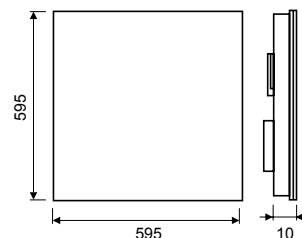
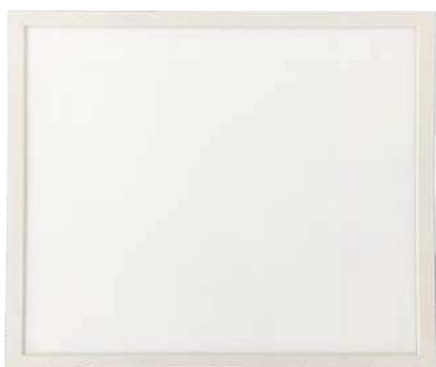

CÓDIGO	W	LM	K	ÓPTICA°	Ra/CRI			L W H			ELECTRÓNICA	PVP
								L	W	H		
60703	40w	4800Lm	4000K	90	>80	-20+40		595	595	10	1-10V	114,95€
60721	40w	4800Lm	4000K	90	>80	-20+40		595	595	10	DALI	171,90€
60704	40w	4800Lm	4000K	90	>80	-20+40		1.195	295	10	1-10V	129,95€
60722	40w	4800Lm	4000K	90	>80	-20+40		1.195	295	10	DALI	182,90€
60705	50w	6000Lm	4000K	90	>80	-20+40		1.195	595	10	1-10V	214,95€
60723	50w	6000Lm	4000K	90	>80	-20+40		1.195	595	10	DALI	300,95€

KIT SUSPENSIÓN

CÓDIGO	METROS	PVP
83128	1	10,95€
88022	1,25	14,95€
88023	1,5	15,45€
88024	2	15,95€
88025	3	16,45€
88026	5	16,95€

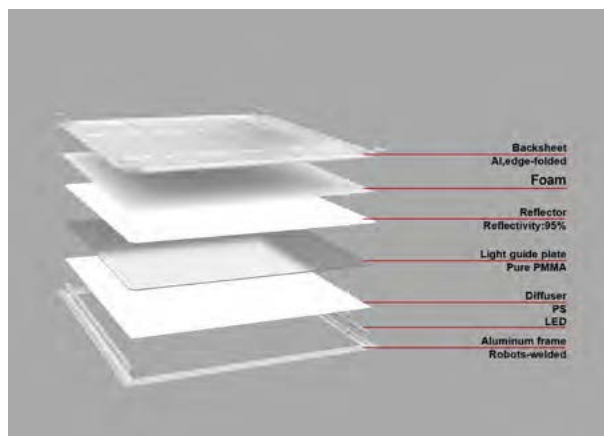

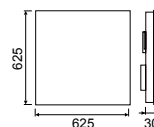

CÓDIGO	W	LM	K	ÓPTICA°		VERSIÓN		ELECTRÓNICA				PVP
									L	W	H	
60710	40w	4000Lm	4000K	90	-20+50	Superficie	B <input type="checkbox"/>	ON/OFF	625	625	30	119,95€
60710A	40w	4000Lm	4000K	90	-20+50	Superficie	B <input type="checkbox"/>	PUSH	625	625	30	139,95€
60710B	40w	4000Lm	4000K	90	-20+50	Superficie	B <input type="checkbox"/>	1-10V	625	625	30	150,50€
60710C	40w	4000Lm	4000K	90	-20+50	Superficie	B <input type="checkbox"/>	DALI	625	625	30	150,50€

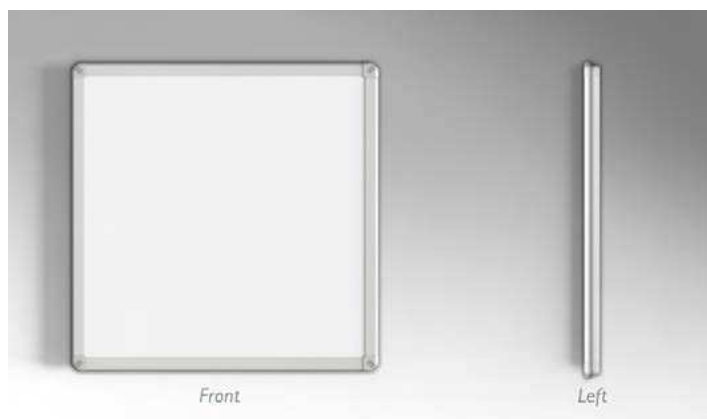

KIT SUSPENSIÓN

CÓDIGO	METROS	PVP
83128	1	10,95€
88022	1,25	14,95€
88023	1,5	15,45€
88024	2	15,95€
88025	3	16,45€
88026	5	16,95€

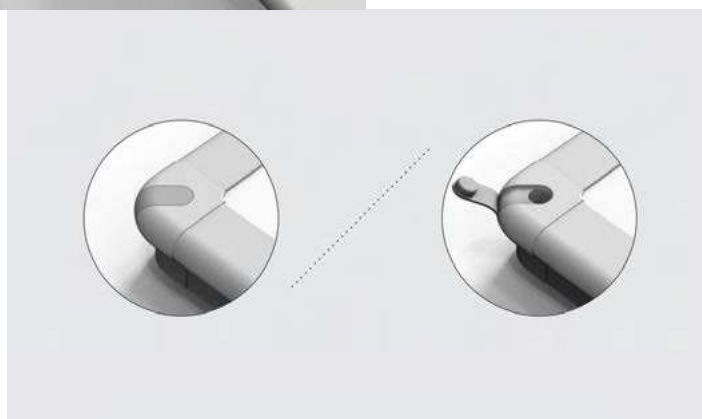

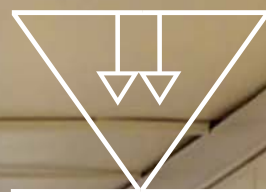

LYOPRO
LEVEL

MARCOS EMPOTRAR/SUPERFICIE
RECESSED/SURFACE FRAMES
CADRES ENCASTRÉS/SURFACE

SITARA



CÓDIGO	DESCRIPCIÓN	VERSIÓN		L	W	H		PVP
20146	Marco Empotrar Panel Led 60x60	Empotrar	B <input type="checkbox"/>	630	630	25	610*610	19,95€
20147	Marco Empotrar Panel Led 120x30	Empotrar	B <input type="checkbox"/>	1230	230	25	1210*310	24,95€
20148	Marco Empotrar Panel Led 120x60	Empotrar	B <input type="checkbox"/>	1230	630	25	1210*610	32,95€
10146	Marco Superficie Panel Led 60x60	Superficie	B <input type="checkbox"/>	605	605	48		26,95€
10147	Marco Superficie Panel Led 120x30	Superficie	B <input type="checkbox"/>	1205	305	48		27,95€
10148	Marco Superficie Panel Led 120x60	Superficie	B <input type="checkbox"/>	1205	605	48		41,95€

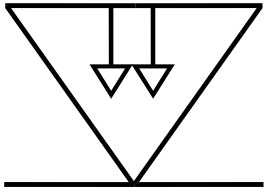

LYOPRO
LEVEL



ILUMINACIÓN INDUSTRIAL
INDUSTRIAL LIGHTING
ÉCLAIRAGE INDUSTRIEL

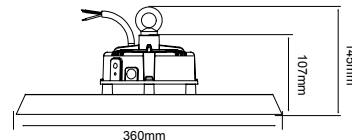
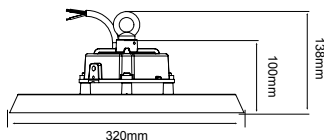
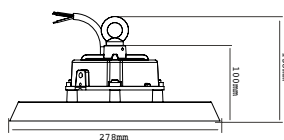
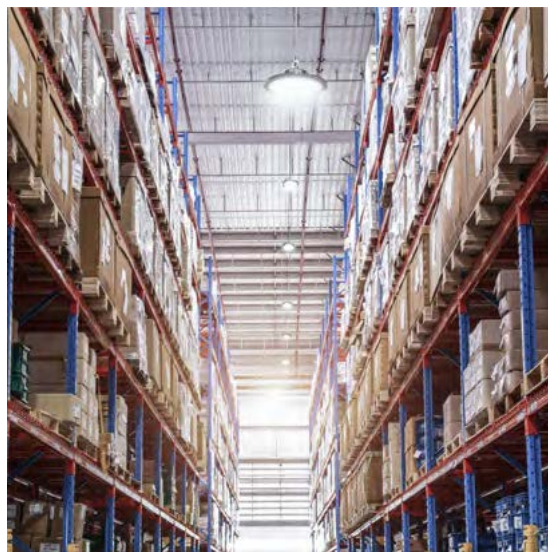

CÓDIGO	W	LM	K	ÓPTICA°		Ra/CRI		L	H	ELECTRÓNICA	PVP
64000	100w	16000Lm	4000K	60	N	>80	-30+45	278	100	1-10V	138,95€
64003	100w	16000Lm	4000K	90	N	>80	-30+45	278	100	1-10V	138,95€
64006	100w	16000Lm	4000K	120	N	>80	-30+45	278	100	1-10V	138,95€
64001	150w	24000Lm	4000K	60	N	>80	-30+45	320	100	1-10V	159,95€
64004	150w	24000Lm	4000K	90	N	>80	-30+45	320	100	1-10V	159,95€
64007	150w	24000Lm	4000K	120	N	>80	-30+45	320	100	1-10V	159,95€
64002	200w	32000Lm	4000K	60	N	>80	-30+45	360	107	1-10V	184,96€
64005	200w	32000Lm	4000K	90	N	>80	-30+45	360	107	1-10V	184,96€
64008	200w	32000Lm	4000K	120	N	>80	-30+45	360	107	1-10V	184,96€

ACCESORIOS ANUBIS

REFLECTOR ANUBIS 100W
CÓDIGO: 64020
PVP: 36,95€



REFLECTOR ANUBIS 150W
CÓDIGO: 64021
PVP: 37,95€



REFLECTOR ANUBIS 200W
CÓDIGO: 64022
PVP: 49,95€

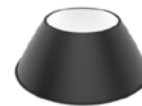

LIRA ANUBIS 100W
CÓDIGO: 64023
PVP: 17,95€



LIRA ANUBIS 150W
CÓDIGO: 64024
PVP: 21,95€



LIRA ANUBIS 200W
CÓDIGO: 64025
PVP: 24,95€





LYOPRO
LEVEL

LUMINARIAS ESTANCAS
WATERPROOF LUMINAIRES
LUMINAIRES ÉTANCHES

BELA

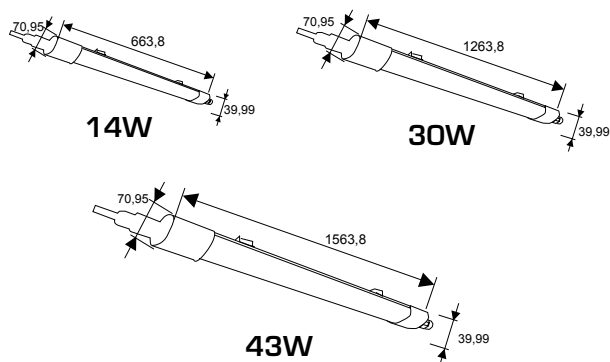

CÓDIGO	W	LM	K	ÓPTICA°	Ra/CRI	Temp. (°C)	Color	L	W	H	ELECTRÓNICA	PVP
60981	14w	1820Lm	4000K	120	>90	-20+40	B <input type="checkbox"/>	663,8	70,95	39,99	ON/OFF	59,95€
60984	30w	3900Lm	4000K	120	>90	-20+40	B <input type="checkbox"/>	1263,8	70,95	39,99	ON/OFF	79,95€
60987	43w	5590Lm	4000K	120	>90	-20+40	B <input type="checkbox"/>	1563,8	70,95	39,99	ON/OFF	99,95€

ACCESORIOS BELA

KIT SUSPENSIÓN 1,5MX2

CÓDIGO: 60989

PVP: 11,75€



CABLE CONEXIÓN 0,5M MACHO/HEMBRA

CÓDIGO: 60990

PVP: 8,90€



CABLE CONEXIÓN 1M MACHO/HEMBRA

CÓDIGO: 60991

PVP: 11,75€



CABLE CONEXIÓN 2M MACHO/HEMBRA

CÓDIGO: 60992

PVP: 15,40€





LYOPRO

LEVEL



ILUMINACIÓN DEPORTIVA Y GRANDES ÁREAS
SPORTS LIGHTING AND LARGE AREAS
ÉCLAIRAGE SPORTIF ET GRANDES SURFACES



400W - 500 - 600W

800W - 1.000 - 1.200W

1.600W - 2.000 - 2.400W

CÓDIGO	W	LM	K		Ra/CRI		ÓPTICA°				ELECTRÓNICA	PVP
								L	W	H		
61840	400w	56000Lm	4000K	P	>80	-30+50	<u>15</u>	480,6	545,66	338,63	1-10V	
61841	500w	70000Lm	4000K	P	>80	-30+50	<u>30</u>	480,6	545,66	338,63	1-10V	
61842	600w	84000Lm	4000K	P	>80	-30+50	<u>60</u>	480,6	545,66	338,63	1-10V	
61843	800w	112000Lm	4000K	P	>80	-30+50	<u>90</u>	891,1	549,01	338,63	1-10V	
61844	1000w	140000Lm	4000K	P	>80	-30+50	<u>120</u>	891,1	549,01	338,63	1-10V	
61845	1200w	168000Lm	4000K	P	>80	-30+50		891,1	549,01	338,63	1-10V	
61846	1600w	224000Lm	4000K	P	>80	-30+50		977	522,5	600	1-10V	
61847	2000w	280000Lm	4000K	P	>80	-30+50		977	522,5	600	1-10V	
61848	2400w	336000Lm	4000K	P	>80	-30+50		977	522,5	600	1-10V	

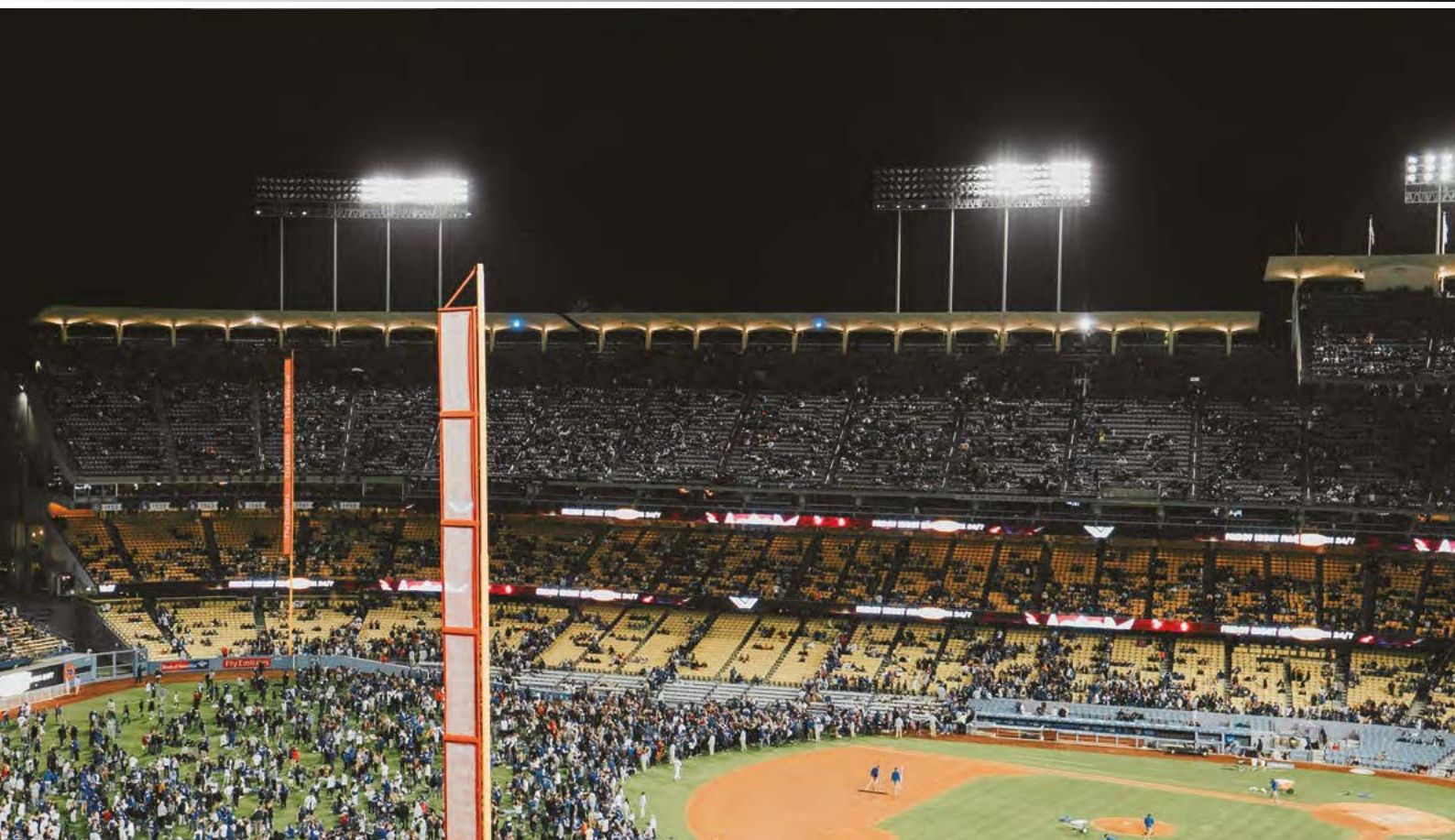



Bajo Proyecto

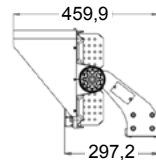
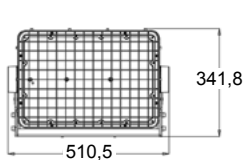
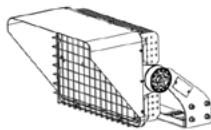
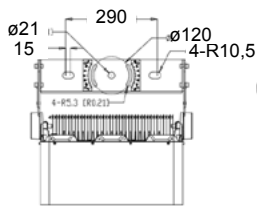
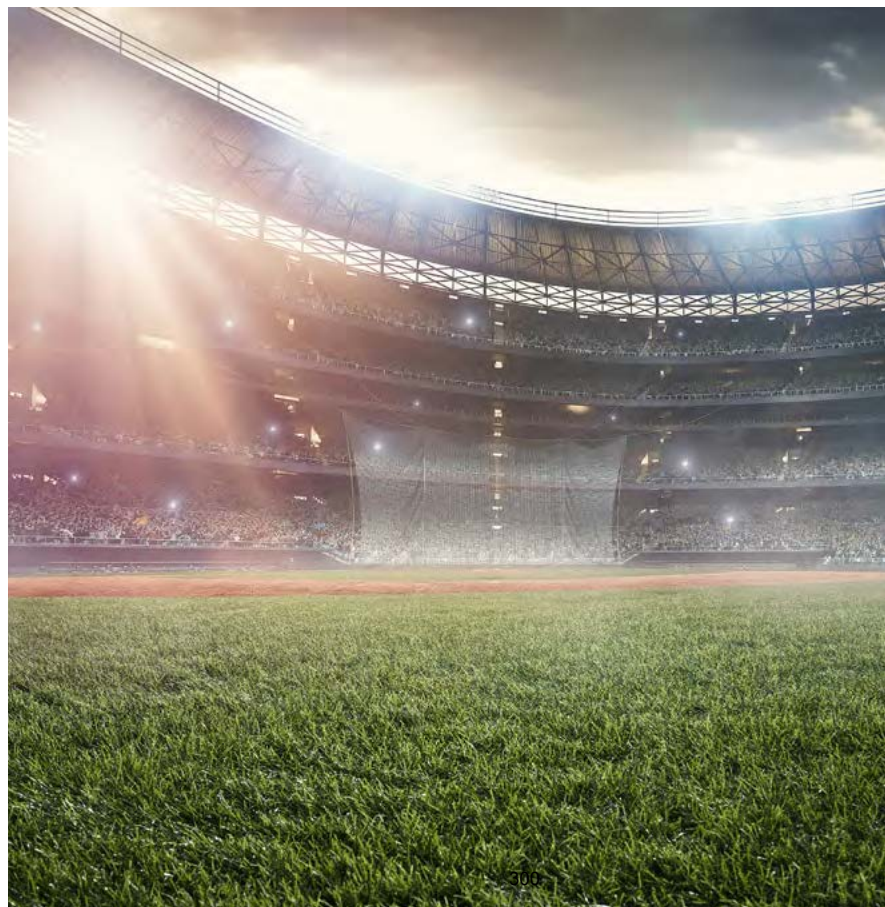

400W - 500W - 600W

H

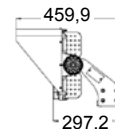
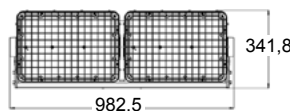
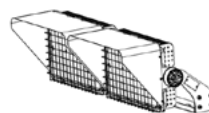
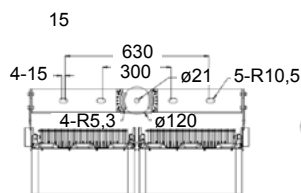

800W - 1.000W - 1.200W

H

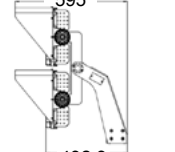
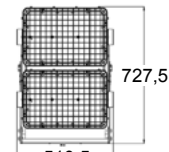
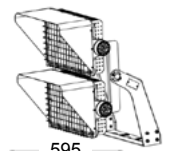
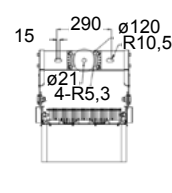

800W - 1.000W - 1.200W

V

CÓDIGO	W	LM	K		Ra/CRI	VERSIÓN	ÓPTICA°	L	W	H	ELECTRÓNICA	PVP
64200	400w	60000Lm	4000K	N	>80	H	<u>25</u>	510,5	459,9	341,8	<u>SR</u>	ON/OFF
64201	500w	75000Lm	4000K	N	>80	H	<u>40</u>	510,5	459,9	341,8	<u>A</u>	TRIAC
64202	600w	90000Lm	4000K	N	>80	H		510,5	459,9	341,8	<u>B</u>	1-10V
64203	800w	120000Lm	4000K	N	>80	H		982,5	459,9	341,8	<u>C</u>	PUSH/DALI
64204	1000w	120000Lm	4000K	N	>80	H		982,5	459,9	341,8		
64205	1200w	150000Lm	4000K	N	>80	H		982,5	459,9	341,8		
64206	800w	150000Lm	4000K	N	>80	V		510,5	595	727,5		
64207	1000w	180000Lm	4000K	N	>80	V		510,5	595	727,5		
64208	1200w	180000Lm	4000K	N	>80	V		510,5	595	727,5		



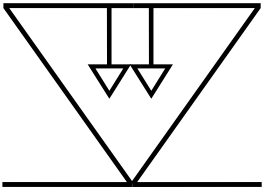

LYOPRO
LEVEL



IP66

GOLDEN

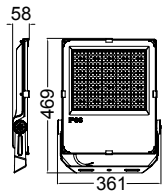

200W

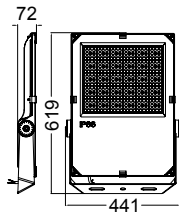

300-400W

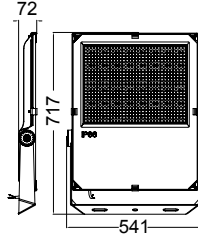

500W



Bracket Design

Bending brackets can be quickly installed using tools, saving installation time and cost.



Eye-bolt



Adjustable bracke

CÓDIGO	W	LM	K	ÓPTICA°	Ra/CRI	🌡️	🎨	🔧			ELECTRÓNICA	PVP
								L	W	H		
64049	200w	30000Lm	4000K	120	>80	-30+45	N	361	58	469	1-10V	284,95€
64070	200w	30000Lm	4000K	135x60	>80	-30+45	N	361	58	469	1-10V	284,95€
64052	300w	45000Lm	4000K	120	>80	-30+45	N	441	72	619	1-10V	455,95€
64073	300w	45000Lm	4000K	135x60	>80	-30+45	N	441	72	619	1-10V	455,95€
64055	400w	56000Lm	4000K	120	>80	-30+45	N	441	72	619	1-10V	599,95€
64076	400w	56000Lm	4000K	135x60	>80	-30+45	N	441	72	619	1-10V	599,95€
64058	500w	75000Lm	4000K	120	>80	-30+45	N	541	72	717	1-10V	789,95€
64079	500w	75000Lm	4000K	135x60	>80	-30+45	N	541	72	717	1-10V	789,95€

STAR

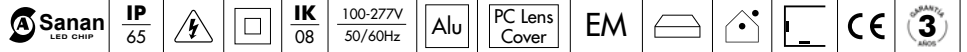

10W 20W 30W 50W 70W 100W 150W 200W

CÓDIGO	W	LM	K	Ra/CRI			ÓPTICA°				ELECTRÓNICA	PVP
								L	W	H		
15401	10w	880Lm	4000K	>80	-30+45	N	120	104	125	27	ON/OFF	13,45€
15402	10w	900Lm	6000K	>80	-30+45	N	120	104	125	27	ON/OFF	13,45€
15403	20w	1760Lm	3000K	>80	-30+45	N	120	125	152	27	ON/OFF	21,95€
15404	20w	1780Lm	4000K	>80	-30+45	N	120	125	152	27	ON/OFF	21,95€
15405	20w	1800Lm	6000K	>80	-30+45	N	120	125	152	27	ON/OFF	21,95€
15406	30w	2660Lm	3000K	>80	-30+45	N	120	168	209	27	ON/OFF	32,95€
15407	30w	2680Lm	4000K	>80	-30+45	N	120	168	209	27	ON/OFF	32,95€
15408	30w	2700Lm	6000K	>80	-30+45	N	120	168	209	27	ON/OFF	32,95€
15409	50w	4460Lm	3000K	>80	-30+45	N	120	200	237	36	ON/OFF	44,95€
15410	50w	4480Lm	4000K	>80	-30+45	N	120	200	237	36	ON/OFF	44,95€
15411	50w	4500Lm	6000K	>80	-30+45	N	120	200	237	36	ON/OFF	44,95€
15412	70w	6260Lm	3000K	>80	-30+45	N	120	282	321	38	ON/OFF	85,90€
15413	70w	6280Lm	4000K	>80	-30+45	N	120	282	321	38	ON/OFF	85,90€
15414	70w	6300Lm	6000K	>80	-30+45	N	120	282	321	38	ON/OFF	85,90€
15415	100w	8960Lm	3000K	>80	-30+45	N	120	282	321	38	ON/OFF	92,95€
15416	100w	8980Lm	4000K	>80	-30+45	N	120	282	321	38	ON/OFF	92,95€
15417	100w	9000Lm	6000K	>80	-30+45	N	120	282	321	38	ON/OFF	92,95€
15419	150w	13480Lm	4000K	>80	-30+45	N	120	333	420	51	ON/OFF	159,95€
15420	150w	13500Lm	6000K	>80	-30+45	N	120	333	420	51	ON/OFF	159,95€
15422	200w	17980Lm	4000K	>80	-30+45	N	120	385	470	51	ON/OFF	225,75€
15423	200w	18000Lm	6000K	>80	-30+45	N	120	385	470	51	ON/OFF	225,75€

STAR

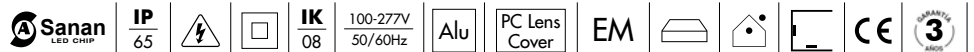

Especificaciones sensor / Sensor specifications / Spécifications du capteur

Angulo detección 120° / *Detection angle 120°* / Angle de détection 120°
 Distancia de detección 8-10 metros / *Detection distance 8-10 meters* / Distance de détection 8-10 mètres
 Tiempo de encendido 10 segundos a 5 minutos ajustable / *On time 10 seconds to 5 minutes adjustable* /
 A l'heure 10 secondes à 5 minutes réglable

CÓDIGO	W	LM	K	Ra/CRI			ÓPTICA°				ELECTRÓNICA	PVP
								L	W	H		
15429	30w	2460Lm	3000K	>80	-30+45	N	120	168	252	54	ON/OFF	64,95€
15430	30w	2480Lm	4000K	>80	-30+45	N	120	168	252	54	ON/OFF	64,95€
10079	30w	2500Lm	6000K	>80	-30+45	N	120	168	252	54	ON/OFF	64,95€
15432	50w	4460Lm	3000K	>80	-30+45	N	120	200	287	57	ON/OFF	69,95€
15433	50w	4480Lm	4000K	>80	-30+45	N	120	200	287	57	ON/OFF	69,95€
15434	50w	4500Lm	6000K	>80	-30+45	N	120	200	287	57	ON/OFF	69,95€

BETTER

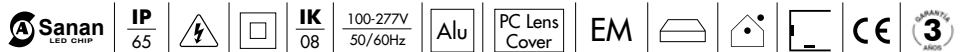

10W



20W



30W



50W

CÓDIGO	W	LM	K	Ra/CRI			ÓPTICA°				ELECTRÓNICA	PVP
								L	W	H		
15200	10w	860Lm	3000K	>80	-30+45	B <input type="checkbox"/>	120	101	125	28,5	ON/OFF	16,90€
15210	10w	880Lm	4000K	>80	-30+45	B <input type="checkbox"/>	120	101	125	28,5	ON/OFF	16,90€
15201	10w	900Lm	6000K	>80	-30+45	B <input type="checkbox"/>	120	101	125	28,5	ON/OFF	16,90€
15202	20w	1760Lm	3000K	>80	-30+45	B <input type="checkbox"/>	120	129	151	29,5	ON/OFF	28,20€
15211	20w	1780Lm	4000K	>80	-30+45	B <input type="checkbox"/>	120	129	151	29,5	ON/OFF	28,20€
15203	20w	1800Lm	6000K	>80	-30+45	B <input type="checkbox"/>	120	129	151	29,5	ON/OFF	28,20€
15204	30w	2660Lm	3000K	>80	-30+45	B <input type="checkbox"/>	120	163	186	34	ON/OFF	41,75€
15212	30w	2680Lm	4000K	>80	-30+45	B <input type="checkbox"/>	120	163	186	34	ON/OFF	41,75€
15205	30w	2700Lm	6000K	>80	-30+45	B <input type="checkbox"/>	120	163	186	34	ON/OFF	41,75€
15206	50w	4460Lm	3000K	>80	-30+45	B <input type="checkbox"/>	120	193	227	37	ON/OFF	56,45€
15213	50w	4480Lm	4000K	>80	-30+45	B <input type="checkbox"/>	120	193	227	37	ON/OFF	56,45€
15207	50w	4500Lm	6000K	>80	-30+45	B <input type="checkbox"/>	120	193	227	37	ON/OFF	56,45€

BETTER

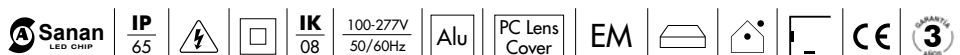

Twilight Sensor

Especificaciones sensor / Sensor specifications / Spécifications du capteur

Angulo detección 120° / *Detection angle 120°* / Angle de détection 120°
 Distancia de detección 8-10 metros / *Detection distance 8-10 meters* / Distance de détection 8-10 mètres
 Tiempo de encendido 10 segundos a 5 minutos ajustable / *On time 10 seconds to 5 minutes adjustable* /
 A l'heure 10 secondes à 5 minutes réglable

CÓDIGO	W	LM	K	Ra/CRI			ÓPTICA°				ELECTRÓNICA	PVP
								L	W	H		
15219	20w	1760Lm	3000K	>80	-30+45	B <input type="checkbox"/>	120	129	183	57	ON/OFF	51,95€
15220	20w	1780Lm	4000K	>80	-30+45	B <input type="checkbox"/>	120	129	183	57	ON/OFF	51,95€



LYOPRO
LEVEL

ILUMINACIÓN DE EXTERIOR EMPOTRAR
OUTDOOR RECESSED LIGHTING
ÉCLAIRAGE ENCASTRÉ EXTÉRIEUR

PILEA

EPISTAR
LED CHIP

IP
67



IK
10

Alu

Inox
316

Glass
Frosted

50 CM



3
AÑOS

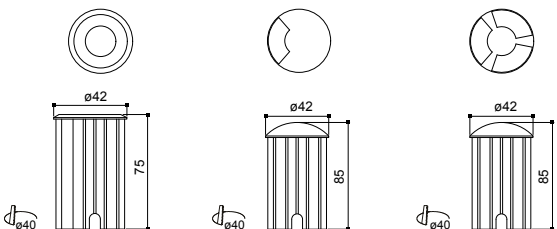

Realizar drenaje correcta (mín. 300 mm.)



CÓDIGO	W	LM	K	VERSIÓN	ÓPTICA°	VOLTAJE			L	H		PVP	
61053	1w	85Lm	3000K	Redondo	30	220V	-20+50	INOX	42	75	40	68,55€	
61054	1w	90Lm	4000K	Redondo		30	220V	-20+50	INOX	42	75	40	68,55€
61048	1w	85Lm	3000K	Redondo		30	24V	-20+50	INOX	42	75	40	59,55€
61049	1w	90Lm	4000K	Redondo		30	24V	-20+50	INOX	42	75	40	59,55€
61056	1w	85Lm	3000K	Redondo 1 salida	70	220V	-20+50	INOX	42	85	40	91,35€	
61057	1w	90Lm	4000K	Redondo 1 salida	70	220V	-20+50	INOX	42	85	40	91,35€	
61059	1w	85Lm	3000K	Redondo 2 salidas	70	220V	-20+50	INOX	42	85	40	98,35€	
61060	1w	90Lm	4000K	Redondo 2 salidas	70	220V	-20+50	INOX	42	85	40	98,35€	

ANDREA

OSRAM
LED CHIP

IP
65



UGR < 19

IK
07

220-240V
50/60Hz

Alu

Glass
Tempered



3
AÑOS

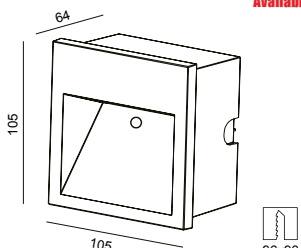

96x96

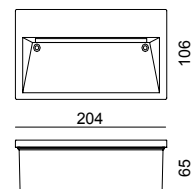

196x96

CÓDIGO	W	LM	K	ÓPTICA°	Ra/CRI			L	W	H		PVP
61480	3w	150Lm	3000K	120	>80	-20+50	A	105	105	64	96x96	44,95€
61481	3w	180Lm	4000K	120	>80	-20+50	A	105	105	64	96x96	44,95€
61483	9w	450Lm	3000K	120	>80	-20+50	A	106	204	65	196x96	74,95€
61484	9w	520Lm	4000K	120	>80	-20+50	A	106	204	65	196x96	74,95€

COOPER

OSRAM
LED CHIP

IP
65



UGR < 19

IK
07

220-240V
50/60Hz

Alu

Glass
Tempered

50 CM



CE

3

3

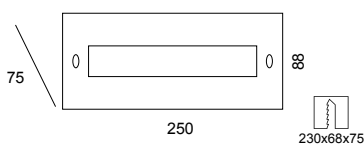

CÓDIGO	W	LM	K	ÓPTICA°	Ra/CRI	Adjustable	Color	L	W	H	Mounting	PVP
61071	8w	220Lm	3000K	42	>80	-20+50	A	250	88	75	230*68*75	146,20€
61072	8w	220Lm	4000K	42	>80	-20+50	A	250	88	75	230*68*75	146,20€

VERA

bridgelux
LED CHIP

IP
67



IK
08

100-240V
50/60Hz

Alu

Inox
316

Glass
Frosted

3 METROS



CE

3

3

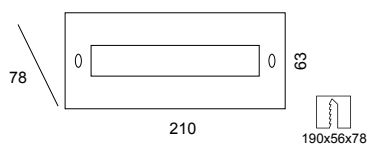

CÓDIGO	W	LM	K	ÓPTICA°	Ra/CRI	Adjustable	Color	L	W	H	Mounting	PVP
61045	6w	570Lm	3000K	120	>80	-30+60	INOX	210	63	78	190*56*78	249,95€
61046	6w	600Lm	4000K	120	>80	-30+60	INOX	210	63	78	190*56*78	249,95€

CIANA

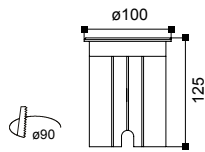
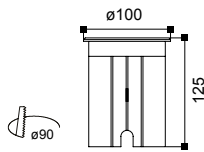
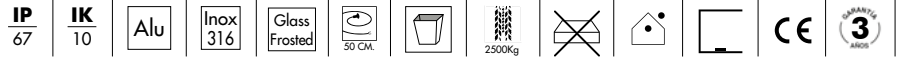

Realizar drenaje correcto (mín. 300 mm.)



CÓDIGO	TIPO LÁMPARA	VERSIÓN			L	H		PVP
61051	GU-10	Redondo	-20+50	INOX	100	125	90	54,80€
61052	GU-10	Cuadrado	-20+50	INOX	100	125	90	58,00€

HATRIA

EPISTAR
LED CHIP

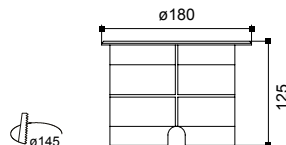
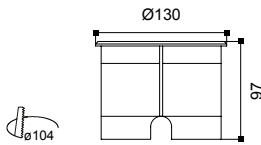

Realizar drenaje correcto (mín. 300 mm.)



CÓDIGO	W	LM	K	ÓPTICA°	Ra/CRI			L	H		PVP
61062	6w	510Lm	3000K	30	>80	-20+50	INOX	130	97	104	113,95€
61063	6w	550Lm	4000K	30	>80	-20+50	INOX	130	97	104	113,95€
61065	12w	900Lm	3000K	30	>80	-20+50	INOX	180	125	145	182,75€
61066	12w	960Lm	4000K	30	>80	-20+50	INOX	180	125	145	182,75€

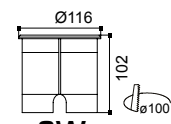

6W

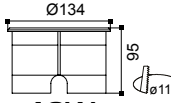

12W

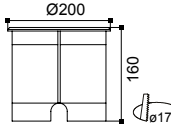

18W



CÓDIGO	W	LM	K	ÓPTICA°	Ra/CRI			L	H		PVP
62011	6w	570Lm	3000K	15	>80	-30+60	INOX	116	102	100	299,95€
62012	6w	570Lm	3000K	25	>80	-30+60	INOX	116	102	100	
62013	6w	570Lm	3000K	30	>80	-30+60	INOX	116	102	100	
62014	6w	570Lm	3000K	45	>80	-30+60	INOX	116	102	100	
62015	6w	570Lm	3000K	60	>80	-30+60	INOX	116	102	100	
62016	6w	600Lm	4000K	15	>80	-30+60	INOX	116	102	100	
62017	6w	600Lm	4000K	25	>80	-30+60	INOX	116	102	100	
62018	6w	600Lm	4000K	30	>80	-30+60	INOX	116	102	100	
62019	6w	600Lm	4000K	45	>80	-30+60	INOX	116	102	100	
62020	6w	600Lm	4000K	60	>80	-30+60	INOX	116	102	100	
62026	12w	1140Lm	3000K	15	>80	-30+60	INOX	134	95	119	494,95€
62027	12w	1140Lm	3000K	25	>80	-30+60	INOX	134	95	119	
62028	12w	1140Lm	3000K	30	>80	-30+60	INOX	134	95	119	
62029	12w	1140Lm	3000K	45	>80	-30+60	INOX	134	95	119	
62030	12w	1140Lm	3000K	60	>80	-30+60	INOX	134	95	119	
62031	12w	1200Lm	4000K	15	>80	-30+60	INOX	134	95	119	
62032	12w	1200Lm	4000K	25	>80	-30+60	INOX	134	95	119	
62033	12w	1200Lm	4000K	30	>80	-30+60	INOX	134	95	119	
62034	12w	1200Lm	4000K	45	>80	-30+60	INOX	134	95	119	
62035	12w	1200Lm	4000K	60	>80	-30+60	INOX	134	95	119	
62071	18w	1710Lm	3000K	8	>80	-30+60	INOX	200	160	178	749,95€
62072	18w	1710Lm	3000K	10	>80	-30+60	INOX	200	160	178	
62073	18w	1710Lm	3000K	17	>80	-30+60	INOX	200	160	178	
62074	18w	1710Lm	3000K	23	>80	-30+60	INOX	200	160	178	
62075	18w	1710Lm	3000K	28	>80	-30+60	INOX	200	160	178	
62076	18w	1710Lm	3000K	43	>80	-30+60	INOX	200	160	178	
62077	18w	1710Lm	3000K	58	>80	-30+60	INOX	200	160	178	
62078	18w	1710Lm	3000K	95	>80	-30+60	INOX	200	160	178	
62079	18w	1800Lm	4000K	8	>80	-30+60	INOX	200	160	178	
62080	18w	1800Lm	4000K	10	>80	-30+60	INOX	200	160	178	
62081	18w	1800Lm	4000K	17	>80	-30+60	INOX	200	160	178	
62082	18w	1800Lm	4000K	23	>80	-30+60	INOX	200	160	178	
62083	18w	1800Lm	4000K	28	>80	-30+60	INOX	200	160	178	
62084	18w	1800Lm	4000K	43	>80	-30+60	INOX	200	160	178	
62085	18w	1800Lm	4000K	58	>80	-30+60	INOX	200	160	178	
62086	18w	1800Lm	4000K	95	>80	-30+60	INOX	200	160	178	

ILUMINACIÓN EXTERIOR SUPERFICIE
OUTDOOR SURFACE LIGHTING
ÉCLAIRAGE DE SURFACE EXTÉRIEUR



LYOPRO
LEVEL



CÓDIGO	W	LM	K	VERSIÓN	ÓPTICA°	Ra/CRI			L	H	PVP
61080	3w	255Lm	3000K	Superficie	36	>80	-20+40	A	66	45	43,55€
61081	3w	270Lm	4000K	Superficie	36	>80	-20+40	A	66	45	43,55€
61083	7w	595Lm	3000K	Superficie	36	>80	-20+40	A	100	66	54,80€
61084	7w	630Lm	4000K	Superficie	36	>80	-20+40	A	100	66	54,80€
61086	12w	1020Lm	3000K	Superficie	36	>80	-20+40	A	100	66	73,05€
61087	12w	1080Lm	4000K	Superficie	36	>80	-20+40	A	100	66	73,05€
61089	3w	255Lm	3000K	Pincho	36	>80	-20+40	A	66	45	45,70€
61090	3w	270Lm	4000K	Pincho	36	>80	-20+40	A	66	45	45,70€
61092	7w	595Lm	3000K	Pincho	36	>80	-20+40	A	100	66	56,95€
61093	7w	630Lm	4000K	Pincho	36	>80	-20+40	A	100	66	56,95€
61095	12w	1020Lm	3000K	Pincho	36	>80	-20+40	A	100	66	75,25€
61096	12w	1080Lm	4000K	Pincho	36	>80	-20+40	A	100	66	75,25€



MIGUEL

CREE
LED CHIP

IP 66



IK 08

220-240V
50/60Hz

Inox 316

Alu



CE

3
Años

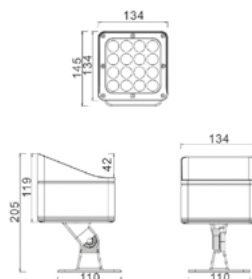

CÓDIGO	W	LM	K	Ra/CRI	°C	Color	ÓPTICA°	L W H			PVP
								L	W	H	
61210	9w	990Lm	4000K	>80	-25+45	GT	05	96	96	152	159,05€
61211	18w	2160Lm	4000K	>80	-25+45	GT	10	96	96	172	214,95€
61212	32w	3840Lm	4000K	>80	-25+45	GT	15 25 30 40 60	134	134	205	376,25€

ROY

CREE
LED CHIP

IP 66



IK 08

220-240V
50/60Hz

Inox 316

Alu



CE

3
Años

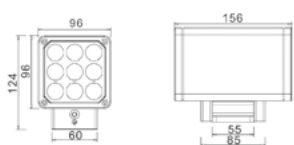

CÓDIGO	W	LM	K	Ra/CRI	°C	Color	ÓPTICA°	L W H			PVP
								L	W	H	
61213	18w	2160Lm	4000K	>80	-25+45	GT	05	96	156	124	376,25€
61214	36w	4320Lm	4000K	>80	-25+45	GT	10 15 25 30 40 60	96	156	164	430,00€

HANA

OSRAM
LED DRIVER

IP 66



IK 08

220-240V
50/60Hz

Inox 316

Alu



CE

3
Años

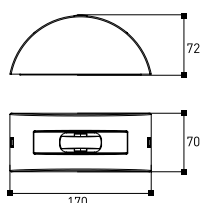

New

Available in May







CÓDIGO	W	LM	K	Ra/CRI	°C	Color	ÓPTICA°	L W H			PVP
								L	W	H	
61098	3w	240Lm	3000K	>80	-25+45	GT	10-180	170	72	70	89,95€
61099	3w	240Lm	4000K	>80	-25+45	GT	10-180	170	72	70	89,95€

COSMOS



IP 54 |  |  | 220-240V 50/60Hz |  |  |  |  |  |  | 



CÓDIGO	W	LM	K	Ra/CRI			ÓPTICA°				PVP
								L	W	H	
11277	14w	1000Lm	4000K	>80	-20+40	A 	110	212	119	60,5	19,95€
11292	14w	1000Lm	4000K	>80	-20+40	B 	110	212	119	60,5	19,95€





IP 54 |  |  | 220-240V 50/60Hz |  |  |  |  |  |  | 

CÓDIGO	W	LM	K	Ra/CRI			ÓPTICA°	Ø	ALTURA	PVP
11298	14w	1000Lm	4000K	>80	-20+40	B 	110	215mm	80mm	24,95€

IP 54 |  |  | 220-240V 50/60Hz |  |  |  |  |  |  | 







CÓDIGO	W	LM	K	Ra/CRI			ÓPTICA°	Ø	ALTURA	PVP
11304	14w	1000Lm	4000K	>80	-20+40	B 	110	215mm	80mm	26,95€



Especificaciones sensor / Sensor specifications / Spécifications du capteur





Angulo detección 120° / *Detection angle 120°* / Angle de détection 120°
 Distancia de detección 8-10 metros / *Detection distance 8-10 meters* / Distance de détection 8-10 mètres
 Tiempo de encendido 10 segundos a 5 minutos ajustable / *On time 10 seconds to 5 minutes adjustable* /
 A l'heure 10 secondes à 5 minutes réglable

CÓDIGO	W	LM	K	Ra/CRI			ÓPTICA°	L	W	H	PVP
11280	14w	1000Lm	4000K	>80	-20+40	A 	110	212	119	60,5	39,95€
11295	14w	1000Lm	4000K	>80	-20+40	B 	110	212	119	60,5	39,95€

Especificaciones sensor / Sensor specifications / Spécifications du capteur

Angulo detección 120° / *Detection angle 120°* / Angle de détection 120°
 Distancia de detección 8-10 metros / *Detection distance 8-10 meters* / Distance de détection 8-10 mètres
 Tiempo de encendido 10 segundos a 5 minutos ajustable / *On time 10 seconds to 5 minutes adjustable* /
 A l'heure 10 secondes à 5 minutes réglable



CÓDIGO	W	LM	K	Ra/CRI			ÓPTICA°	Ø	ALTURA	PVP
11286	14w	1000Lm	4000K	>80	-20+40	A 	110	215mm	80mm	44,95€
11301	14w	1000Lm	4000K	>80	-20+40	B 	110	215mm	80mm	44,95€

MAYA

EVER LIGHT
Led Chip

EAGLERISE
LED DRIVER

IP
54



IK
04

220-240V
50/60Hz

Alu

PMMA Difusser
Cover

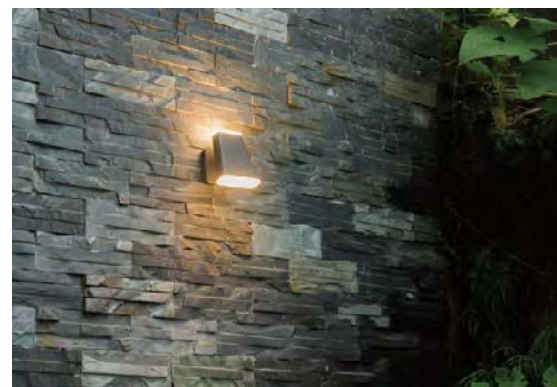
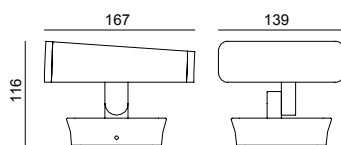

CÓDIGO	W	LM	K	Ra/CRI	Light beam icon	Color palette icon	ÓPTICA°	L			PVP
								L	W	H	
61120	12w	850lm	3000K	>80	-20+40	A	110	167	139	116	150,45€
61121	12w	850lm	4000K	>80	-20+40	A	110	167	139	116	150,45€

VISIA

IP
54

IK
06

220-240V
50/60Hz

Alu

GLASS
Difusser

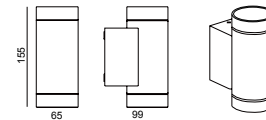
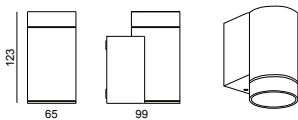

* Lamp not included

CÓDIGO	TIPO LÁMPARA	VERSIÓN	Color palette icon	L			PVP
				L	W	H	
61124	1xGU-10	1 salida	A	99	65	123	45,70€
61127	2xGU-10	2 salidas	A	99	65	155	59,95€

DIANA

New
Available in June

IP
54

IK
06

220-240V
50/60Hz

Alu

GLASS
Difusser

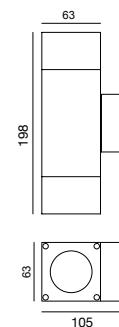
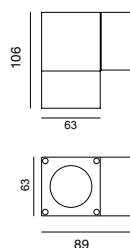

* Lamp not included

CÓDIGO	TIPO LÁMPARA	VERSIÓN	Color palette icon	L			PVP
				L	W	H	
61460	1xGU-10	1 salida	A	89	63	106	45,70€
61461	2xGU-10	2 salidas	A	105	63	198	59,95€

VEGA

EVER LIGHT
Led Chip



IP
54



IK
06

220-240V
50/60Hz

Alu

PMMA Difusser
Cover



CE

3
AÑOS

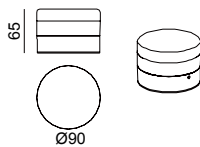

CÓDIGO	W	LM	K	Ra/CRI			ÓPTICA°	L	H	PVP
61141	12w	600Lm	3000K	>80	-20+40	A	110	90	65	80,60€
61142	12w	600Lm	4000K	>80	-20+40	A	110	90	65	80,60€

LINUS

CREE
LED CHIP



IP
54



220-240V
50/60Hz

Alu

Glass
Tempered



CE

3
AÑOS

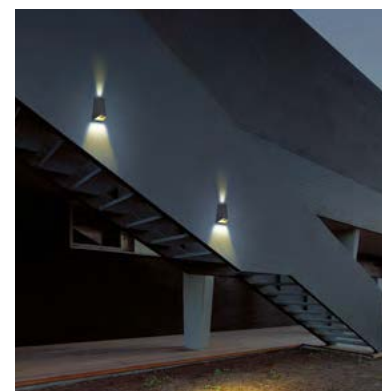
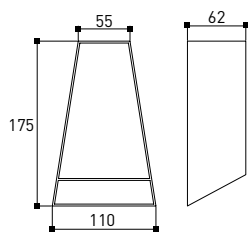

CÓDIGO	W	LM	K	Ra/CRI			ÓPTICA°	L	W	H	PVP
61180	2X4,5w	280Lm	3000K	>80	-20+50	A	15-80	175	110	62	91,35€
61181	2X4,5w	280Lm	4000K	>80	-20+50	A	15-80	175	110	62	91,35€

SYLAR

OSRAM
LED CHIP

IP
65



IK
07

220-240V
50/60Hz

Alu

PC
Difusser



CE

3
AÑOS

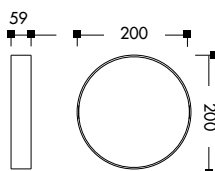

CÓDIGO	W	LM	K	Ra/CRI			ÓPTICA°	L	H	PVP
61074	18w	900Lm	3000K	>80	-20+50	A	105	200	59	118,25€
61075	18w	900Lm	4000K	>80	-20+50	A	105	200	59	118,25€

RAUL

IP 54 | IK 06 | 220-240V 50/60Hz | Alu | Glass Difusser Cover | | | | CE |

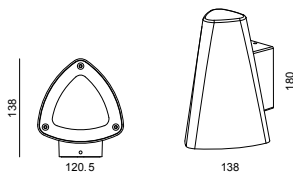

* Lámpara no incluida

CÓDIGO	TIPO LÁMPARA	VERSIÓN			L	W	H	PVP
61145	1xGU-10	1 Salida	A		120,5	138	180	51,55€

NILS

EVER LIGHT Led Chip | | IP 54 | | | IK 04 | 220-240V 50/60Hz | Alu | PMMA Difusser | | | | | CE |

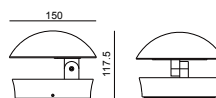

CÓDIGO	W	LM	K	Ra/CRI			ÓPTICA°		L	W	H	PVP
61159	13w	480Lm	3000K	>80	-20+40	A	100		150	150	117,5	106,40€
61160	13w	480Lm	4000K	>80	-20+40	A	100		150	150	117,5	106,40€

NEO

EVER LIGHT Led Chip | | IP 54 | | | IK 06 | 220-240V 50/60Hz | Alu | PMMA Difusser | | | | | CE |

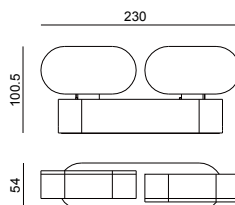

CÓDIGO	W	LM	K	Ra/CRI			ÓPTICA°		L	W	H	PVP
61162	2x6,5w	630Lm	3000K	>80	-20+50	A	100		230	54	100,5	106,40€
61163	2x6,5w	630Lm	4000K	>80	-20+50	A	100		230	54	100,5	106,40€

OTTO

CREE
LED CHIP

LED DRIVER

IP
54



220-240V
50/60Hz

Alu

Opal
PC



CE

5
ANOS

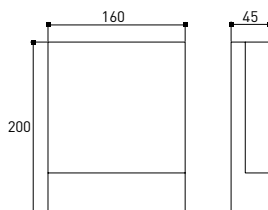

CÓDIGO	W	LM	K	Ra/CRI			ÓPTICA°	L	W	H	PVP
61184	8w	500Lm	4000K	>80	-20+50	A	116	160	45	200	91,35€

KARINA

CREE
LED CHIP

IP
65



220-240V
50/60Hz

Alu

GLASS
Difusser



CE

3
ANOS

New

Available in April

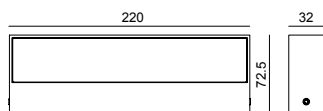

12W

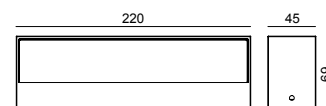
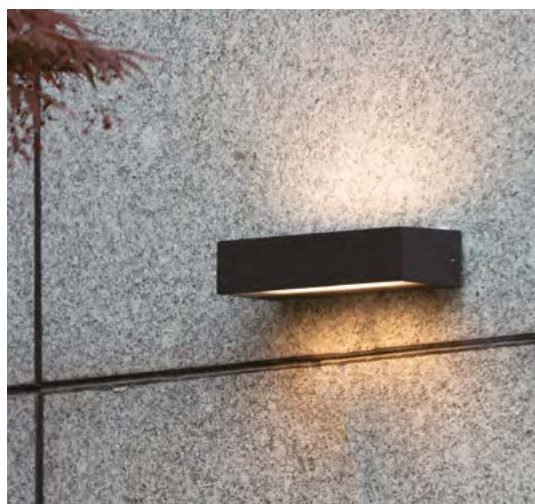

2x8W



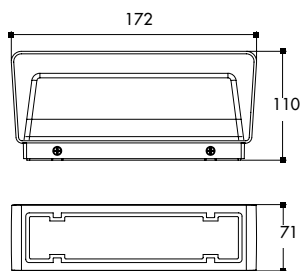

CÓDIGO	W	LM	K	Ra/CRI			ÓPTICA°	L	W	H	PVP
61470	12w	780Lm	3000K	>80	-20+50	A	120	220	72,5	32	59,95€
61471	12w	840Lm	4000K	>80	-20+50	A	120	220	72,5	32	59,95€
61474	2x8w	2x520Lm	3000K	>80	-20+50	A	120	220	69	45	69,95€
61475	2x8w	2x560Lm	4000K	>80	-20+50	A	120	220	69	45	69,95€

ILAN









IP 54 |  | Alu | GLASS Difusser |  |  |  |  | CE | 











* Lamp not included

CÓDIGO	TIPO LÁMPARA	MATERIAL	 A 	VERSIÓN				PVP
					L	W	H	
61175	1xR7S	Aluminio	A 	2 Salidas	172	110	71	39,95€

ALBA

EVER LIGHT Led Chip |  | IP 54 |  |  | IK 07 | 220-240V 50/60Hz | Alu | GLASS Difusser |  |  |  |  |  | CE | 



CÓDIGO	W	LM	K	Ra/CRI		 A 	ÓPTICA°			PVP
								L	H	
61147	12w	600Lm	3000K	>80	-20+40	A 	110	108	173	139,95€
61148	12w	600Lm	4000K	>80	-20+40	A 	110	108	173	139,95€
61150	12w	600Lm	3000K	>80	-20+40	A 	110	108	800	199,95€
61151	12w	600Lm	4000K	>80	-20+40	A 	110	108	800	199,95€

LEXIE

CREE
LED CHIP

EAGLE RISE
LED DRIVER

IP
54



IK
08

220-240V
50/60Hz

Alu

GLASS
Difusser



CE

5
AÑO GARANTÍA

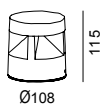

CÓDIGO	W	LM	K	Ra/CRI	-20+40	A	ÓPTICA°	Óptica			PVP
								L	H	H	
61153	8w	150Lm	3000K	>80	-20+40	A	90	108	115	94,95€	
61154	8w	150Lm	4000K	>80	-20+40	A	90	108	115	94,95€	

ARIA

CREE
LED CHIP

EAGLE RISE
LED DRIVER

IP
54



IK
08

220-240V
50/60Hz

Alu

GLASS
Difusser



CE

5
AÑO GARANTÍA

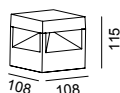

CÓDIGO	W	LM	K	Ra/CRI	-20+60	A	ÓPTICA°	Óptica			PVP
								L	W	H	
61156	8w	130Lm	3000K	>80	-20+60	A	90	108	108	115	99,95€
61157	8w	130Lm	4000K	>80	-20+60	A	90	108	108	115	99,95€

CARLOTA

OSRAM
LED CHIP

LED DRIVER

IP
65



IK
07

220-240V
50/60Hz

Alu

PC
Opal



CE

3
AÑO GARANTÍA

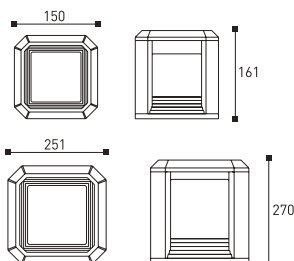

CÓDIGO	W	LM	K	Ra/CRI	-20+50	A	ÓPTICA°	Óptica			PVP
								L	W	H	
61186	12w	700Lm	3000K	>80	-20+50	A	270	150	150	161	113,90€
61187	12w	700Lm	4000K	>80	-20+50	A	270	150	150	161	113,90€
61189	20w	1000Lm	3000K	>80	-20+50	A	270	251	251	270	215,00€
61190	20w	1000Lm	4000K	>80	-20+50	A	270	251	251	270	215,00€

LEIA

OSRAM
LED CHIP



IP
54



IK
08

220-240V
50/60Hz

Alu

PC
Opal



CE

3
Años

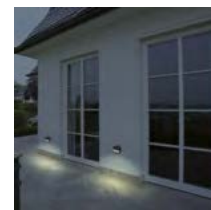
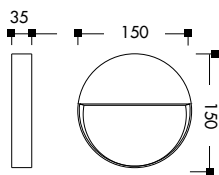

CÓDIGO	W	LM	K	Ra/CRI			ÓPTICA°	L		H	PVP
61192	5w	230Lm	3000K	>80	-20+50	A	80	150		35	67,70€
61193	5w	230Lm	4000K	>80	-20+50	A	80	150		35	67,70€

AGNES

OSRAM
LED CHIP



IP
54



IK
07

220-240V
50/60Hz

Alu

Glass
Tempered



CE

3
Años

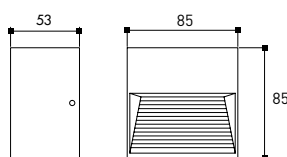

CÓDIGO	W	LM	K	Ra/CRI			ÓPTICA°	L		W	H	PVP
61201	3w	180Lm	3000K	>80	-20+50	A	65	85		85	53	56,95€
61202	3w	180Lm	4000K	>80	-20+50	A	65	85		85	53	56,95€

SIGAL

OSRAM
LED CHIP



IP
54



IK
07

220-240V
50/60Hz

Alu

PC
Opal



CE

3
Años

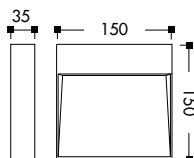

CÓDIGO	W	LM	K	Ra/CRI			ÓPTICA°	L		W	H	PVP
61195	5w	300Lm	3000K	>80	-20+50	A	270	150		150	35	67,70€
61196	5w	300Lm	4000K	>80	-20+50	A	270	150		150	35	67,70€

VIGGO

OSRAM
LED CHIP



IP
54



IK
07

220-240V
50/60Hz

Alu

PC
Opal



CE

3
Años

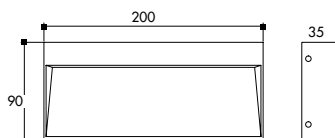

CÓDIGO	W	LM	K	Ra/CRI			ÓPTICA°	L		W	H	PVP
61198	7w	480Lm	3000K	>80	-20+50	A	80	200		90	35	79,85€
61199	7w	480Lm	4000K	>80	-20+50	A	80	200		90	35	79,85€

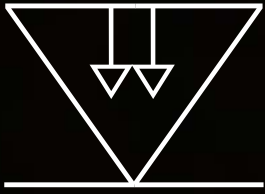

LYOPRO
LEVEL

ILUMINACIÓN SUBACUÁTICA
UNDERWATER LIGHTING
ÉCLAIRAGE SOUS-MARIN

CAIA

CREE
LED CHIP

IP
68

DC 12V

Alu

Inox
316

3 METROS

3 METROS

3 METROS

3 METROS

CE

3

3

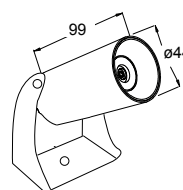

8W

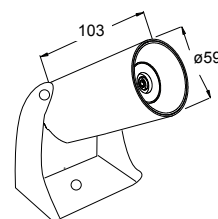

15W

* Power supply 12V not included

CÓDIGO	W	LM	K		Ra/CRI	ÓPTICA°				PVP
								L	H	
61349	8w	640Lm	4000K	INOX	>80	15	-30+60	44	90	215,00€
61350	8w	640Lm	4000K	INOX	>80	24	-30+60	44	90	215,00€
61351	8w	640Lm	4000K	INOX	>80	36	-30+60	44	90	215,00€
61352	8w	640Lm	4000K	INOX	>80	60	-30+60	44	90	215,00€
61364	15w	1200Lm	4000K	INOX	>80	10	-30+60	59	103	376,30€
61365	15w	1200Lm	4000K	INOX	>80	23	-30+60	59	103	376,30€
61366	15w	1200Lm	4000K	INOX	>80	36	-30+60	59	103	376,30€
61370	15w	900Lm	RGB	INOX	>80	10	-30+60	59	103	430,05€
61371	15w	900Lm	RGB	INOX	>80	23	-30+60	59	103	430,05€
61372	15w	900Lm	RGB	INOX	>80	36	-30+60	59	103	430,05€

CONTROLADOR RGB



CÓDIGO: 61312

PVP: 118,20€

CARACTERÍSTICAS

1. Controlador

temperatura de trabajo: -20-60°C
voltaje de suministro: DC5V-24V
salida: 3 canales
modo de conexión: ánodo común
dimensión externa: L 120 X W62 X H24mm
tamaño del embalaje: L 185 X W145 X H52mm
peso neto: 226g
peso bruto: 320g
consumo de energía estática: <1W
corriente de salida: <8A (cada canal)
potencia de salida: 12V: <288W, 24V: <576W

2. Mando

temperatura de trabajo: -20-60°C
modo de fuente de alimentación: AAA * 3
Voltaje de suministro: 1,5 V * 3
frecuencia de transmisión: 2.4Ghz
consumo de energía en espera: 0.015mW
corriente de espera: 60uA
corriente de trabajo: 200uA
corriente de emisión: 1 0mA
distancia de remate: unos 30 m
tiempo en espera: 6 meses
peso control remate: 94g

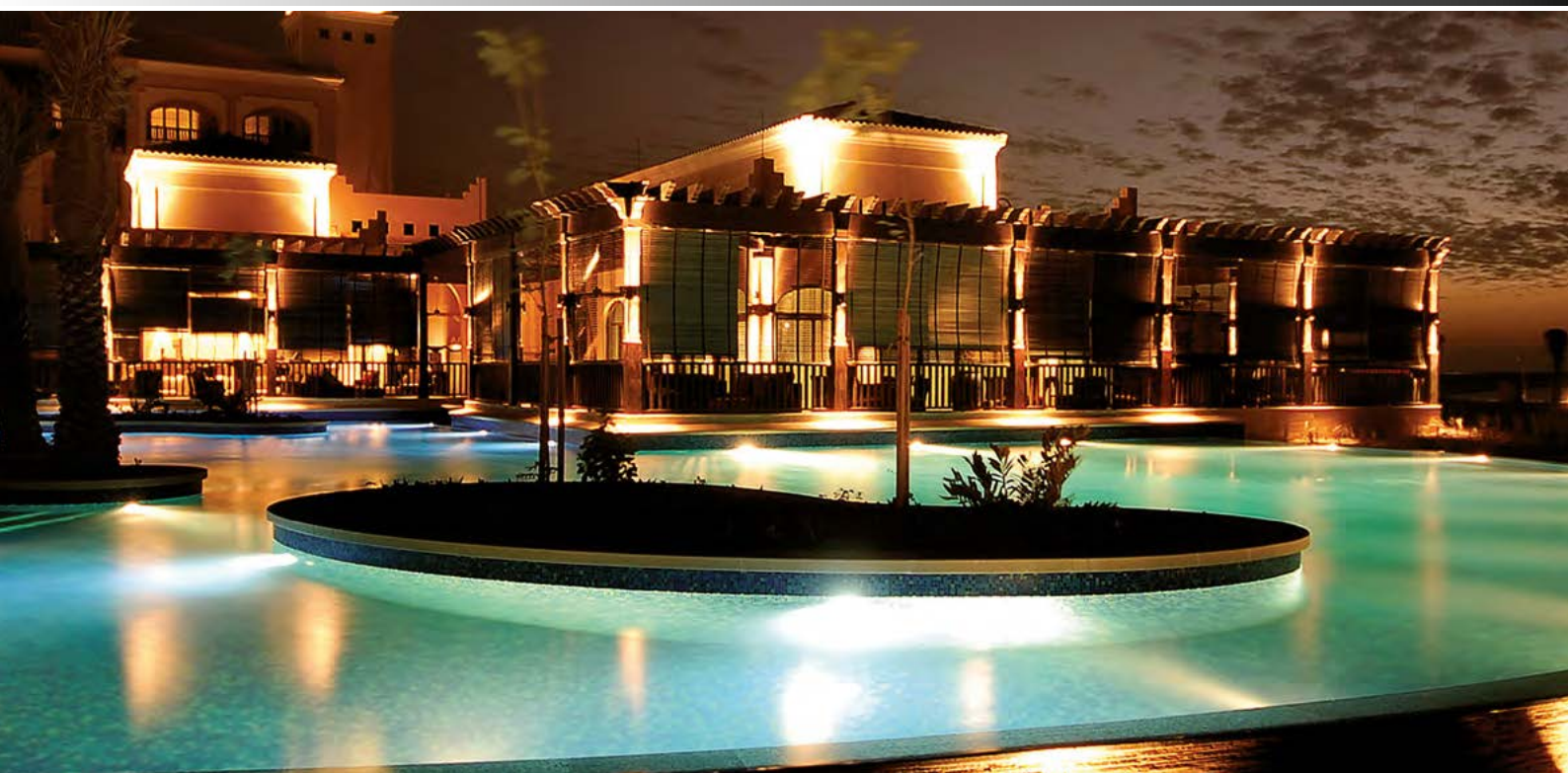

ARALE

EPISTAR
LED CHIP

IP
68

IK
07

DC 12V

Alu

Inox
316

RESIN
Cover

2 METROS

CE

3
AÑOS

6W

24W

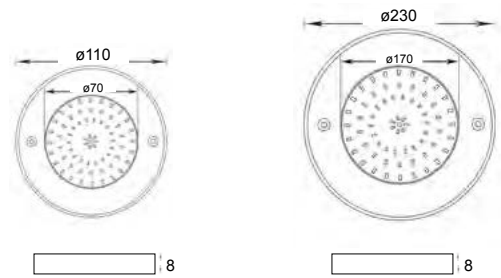

* Power supply 12v not included

CÓDIGO	W	LM	K	VERSIÓN		Ra/CRI	ÓPTICA°		L	H	PVP
61306	6w	480Lm	6000K	Superficie	INOX	>80	120	-20+40	110	8	149,95€
61307	6w	180Lm	RGB	Superficie	INOX	>80	120	-20+40	110	8	159,95€
61310	24w	1920Lm	6000K	Superficie	INOX	>80	120	-20+40	230	8	249,95€
61311	24w	800Lm	RGB	Superficie	INOX	>80	120	-20+40	230	8	269,95€

CONTROLADOR RGB



CÓDIGO: 61312
PVP: 118,20€

CARACTERÍSTICAS

1. Controlador

temperatura de trabajo: -20-60°C
voltaje de suministro: DC5V-24V
salida: 3 canales
modo de conexión: ánodo común
dimensión externa: L 120 X W62 X H24mm
tamaño del embalaje: L 185 X W145 X H52mm
peso neto: 226g
peso bruto: 320g
consumo de energía estática: <1W
corriente de salida: <8A (cada canal)
potencia de salida: 12V: <288W, 24V: <576W

2. Mando

temperatura de trabajo: -20-60°C
modo de fuente de alimentación: AAA * 3
Voltaje de suministro: 1,5 V * 3
frecuencia de transmisión: 2.4Ghz
consumo de energía en espera: 0.015mW
corriente de espera: 60uA
corriente de trabajo: 200uA
corriente de emisión: 1 0mA
distancia de remate: unos 30 m
tiempo en espera: 6 meses
peso control remate: 94g



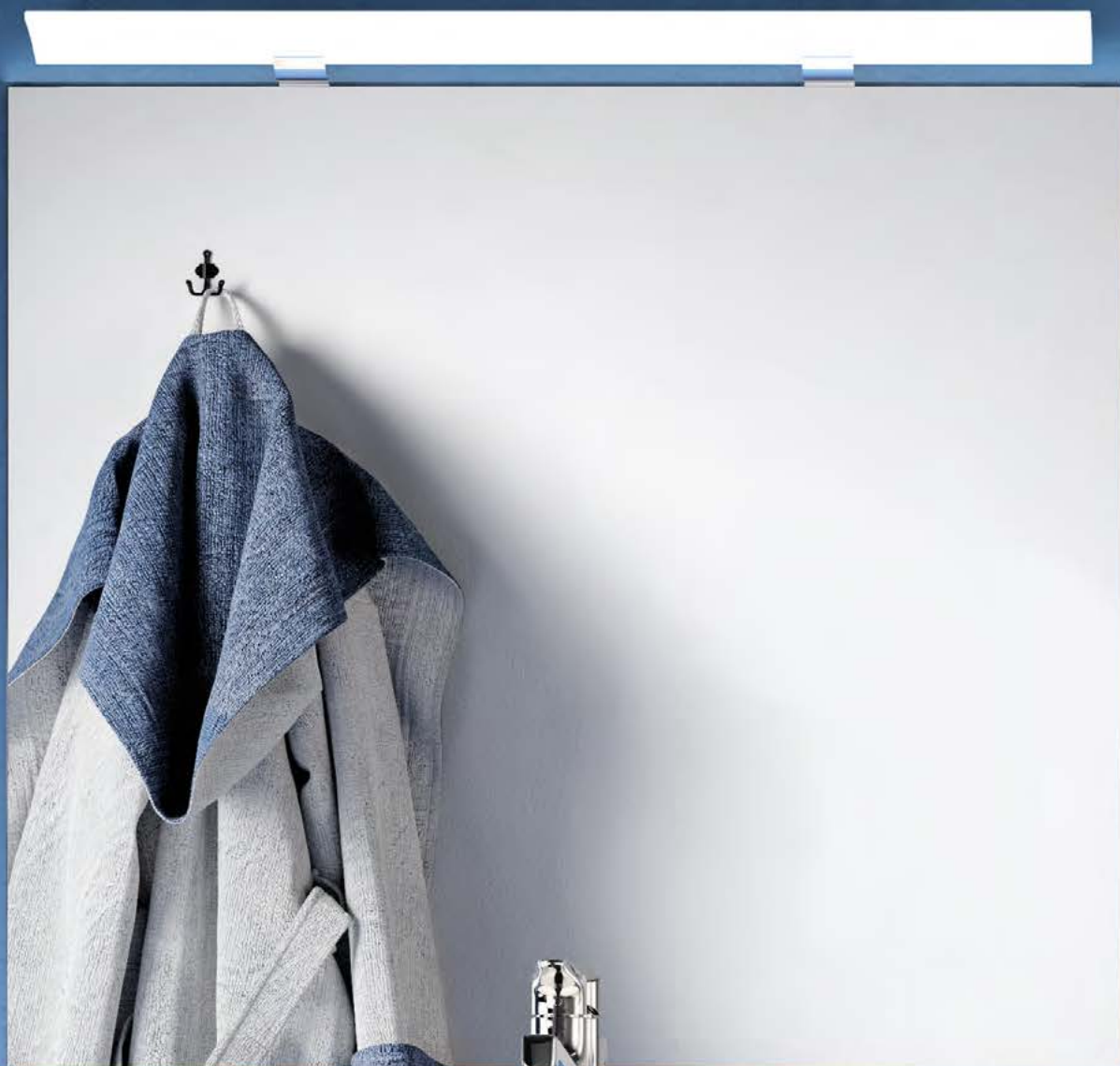

ILUMINACIÓN DE BAÑO
BATHROOM LIGHTING
ÉCLAIRAGE SALLE DE BAIN

ALEIX

IP
44



220-240V
50/60Hz

Alu+ABS

PC Opal
Difusor



CE

5
AÑO

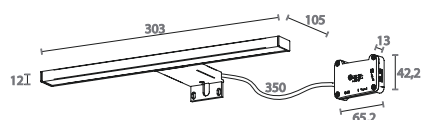

6W

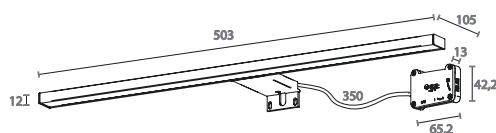

10W

CÓDIGO	W	LM	K	ÓPTICA°	Ra/CRI	°C	PVP
81268662	6w	420Lm	5700K	111	>80	-20+40	34,30€
81278662	10w	710Lm	5700K	111	>80	-20+40	49,35€

NORAH

IP
44



220-240V
50/60Hz

Alu

PC
Difusor



CE

5
AÑO

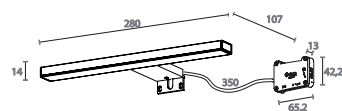

6W

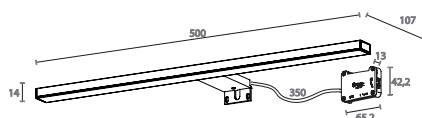

8W

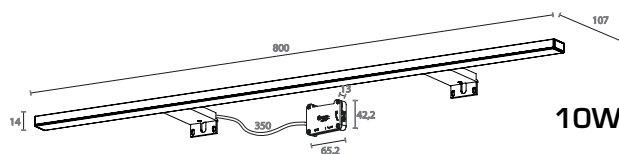

10W

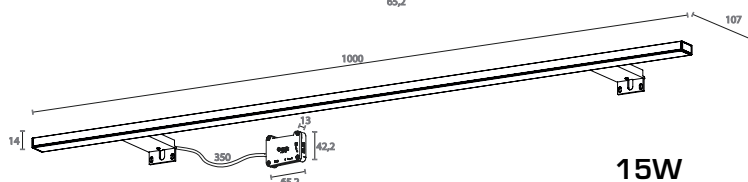



15W

CÓDIGO	W	LM	K	ÓPTICA°	Ra/CRI	°C	PVP
81248372	6w	460Lm	4000K	110	>80	-20+40	47,95€
81258372	8w	570Lm	4000K	110	>80	-20+40	64,40€
81268372	10w	790Lm	4000K	110	>80	-20+40	100,95€
81278372	15w	1260Lm	4000K	110	>80	-20+40	117,10€

SAHAR

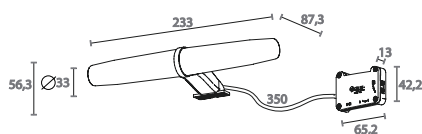
IP 44 |  | 220-240V / 50/60Hz | ABS | PC Opal Difusser |  | CE | 



CÓDIGO	W	LM	K	ÓPTICA°	Ra/CRI		PVP
81200962	6w	420Lm	4000K	187	>80	-20+40	28,95€
81280962	6w	392Lm	5700K	187	>80	-20+40	28,95€

NOA

IP 44 |  | 220-240V / 50/60Hz | PC | PC Opal Difusser |  | CE | 

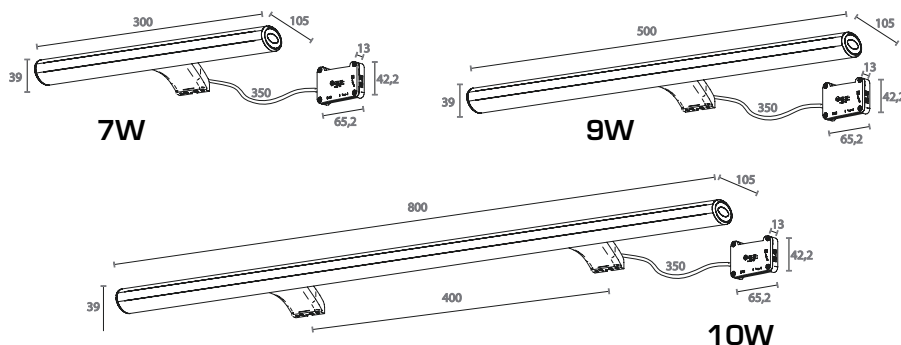

CÓDIGO	W	LM	K	ÓPTICA°	Ra/CRI		PVP
81256672	7w	640Lm	4000K	210	>80	-20+40	57,95€
81266672	9w	920Lm	4000K	210	>80	-20+40	77,30€
81276672	10w	1050Lm	4000K	210	>80	-20+40	117,10€

AFRODITA

IP 44 |  | 220-240V / 50/60Hz | ABS | PC Opal Difusser |  | CE | 

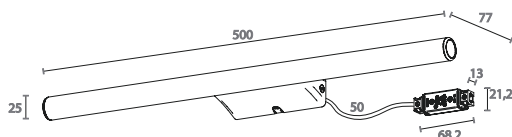

CÓDIGO	W	LM	K	ÓPTICA°	Ra/CRI		PVP
81265572	9w	830Lm	5700K	210	>80	-20+40	66,55€

VIOLETA

IP 44 | 220-240V 50/60Hz | ABS | PC Opal Difusser | CE | 5 años

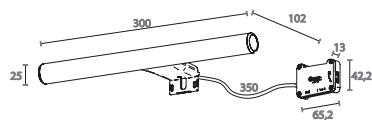

7W

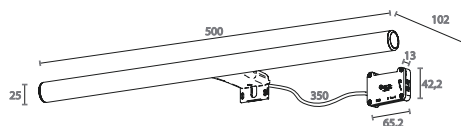

9W

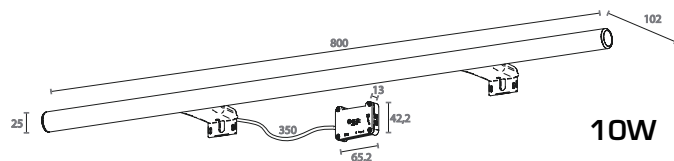

10W

CÓDIGO	W	LM	K	ÓPTICA°	Ra/CRI		PVP
81206272	7w	615Lm	5700K	210	>80	-20+40	45,70€
81216272	9w	830Lm	5700K	210	>80	-20+40	55,80€
81226272	10w	925Lm	5700K	210	>80	-20+40	77,95€

ALTEA

IP 44 | 220-240V 50/60Hz | PC | PC Opal Difusser | CE | 5 años

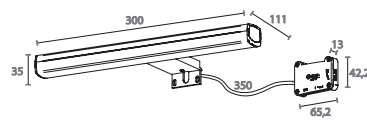

6W

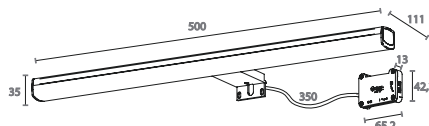

8W

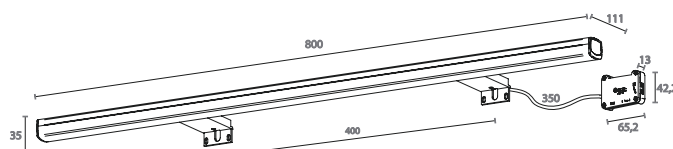

12W

CÓDIGO	W	LM	K	ÓPTICA°	Ra/CRI		PVP
81246182	6w	475Lm	4000K	195	>80	-20+40	66,15€
81256182	8w	635Lm	4000K	195	>80	-20+40	85,90€
81266182	12w	950Lm	4000K	195	>80	-20+40	138,60€

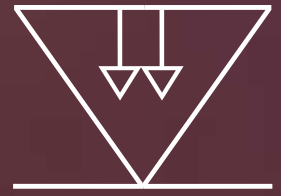

LYOPRO

LEVEL

SISTEMAS DE CONTROL
CONTROL SYSTEMS
SYSTÈMES DE CONTRÔLE

REGULADOR INALAMBRICO AC TRIAC

Ref.: 88503



Como sincronizar el controlador
How to sync controller
Comment synchroniser le contrôleur



Regulador inalambrico AC TRIAC / AC TRIAC wireless controller

Control <i>Input Signal</i>	RF 2.4GHz + Push Dim
Voltaje de entrada <i>Input Voltage</i>	AC 100-240VAC
Tensión de salida <i>Output Voltage</i>	AC 100-240VAC
Corriente de salida <i>Output Current</i>	Max 1A
Potencia de salida <i>Output Power</i>	240W
Tamaño <i>Size</i>	L52 x W52 x H26 mm
Distancia <i>Distance</i>	30M
Temperatura de trabajo <i>Working Temperature</i>	-30°C~+55°C
PVP	49,95€

Instalación:

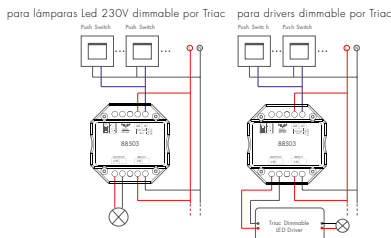

Aplicaciones:



TUYA INTERRUPTOR ON/OFF 1,5A

Ref.: 88555



Tuya interruptor on/off 1,5A / Tuya interruptor on/off 1,5A

Control <i>Input Signal</i>	Tuya APP + RF + Push switch
Voltaje de entrada <i>Input Voltage</i>	AC 100-240V
Tensión de salida <i>Output Voltage</i>	AC 100-240V
Corriente de salida <i>Output Current</i>	Max 1,5A
Potencia de salida <i>Output Power</i>	360W
Tamaño <i>Size</i>	L52 x W52 x H26 mm
Distancia <i>Distance</i>	30M
Temperatura de trabajo <i>Working Temperature</i>	-30°C~+55°C
PVP	87,95€

Instalación:

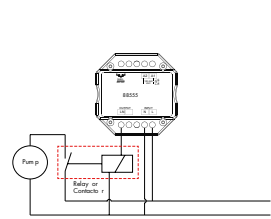
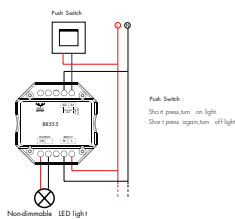

Aplicaciones:

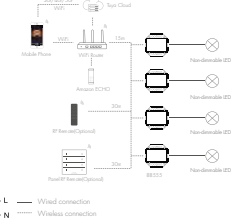

INTERRUPTOR INALAMBRICO ON/OFF 3A

Ref.: 88505



Como sincronizar el controlador
How to sync controller
Comment synchroniser le contrôleur



Control <i>Input Signal</i>	RF 2.4GHz + Push switch
Voltaje de entrada <i>Input Voltage</i>	AC 100-240VAC
Tensión de salida <i>Output Voltage</i>	AC 100-240VAC
Corriente de salida <i>Output Current</i>	Max 3A
Potencia de salida <i>Output Power</i>	720W
Tamaño <i>Size</i>	L52 x W52 x H26 mm
Distancia <i>Distance</i>	30M
Temperatura de trabajo <i>Working Temperature</i>	-30°C~+55°C
PVP	57,95€

Instalación:

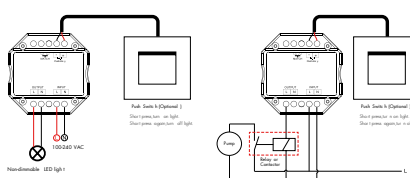

Aplicaciones:



REGULADOR DALI 15A 24V

Ref.: 88564



Tuya regulador DALI 15A 24V | Tuya regulador DALI 15A 24V

Control Input Signal	DALI+Push Dim
Voltaje de entrada Input Voltage	12-24VDC
Tensión de salida Output Voltage	12-24VDC
Corriente de salida Output Current	1CH, 15A
Potencia de salida Output Power	360W
Tamaño Size	L175 x W45 x H27 mm
Distancia Distance	30M
Temperatura de trabajo Working Temperature	-30°C ~ +55°C
PVP	79,95€

Instalación:

88564 connect with DALI master

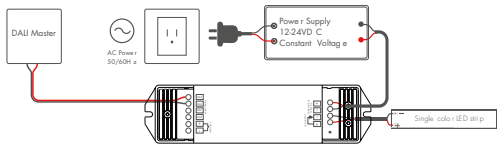

88564 connect with push switch

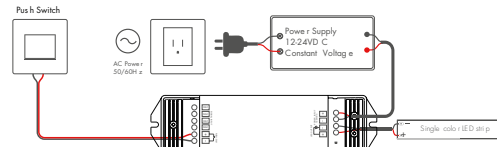

REGULADOR DALI 4X5A 24V

Ref.: 88565



Tuya regulador DALI 4X5A 24V | Tuya regulador DALI 4X5A 24V

Control Input Signal	DALI
Voltaje de entrada Input Voltage	12-24VDC
Tensión de salida Output Voltage	12-24VDC
Corriente de salida Output Current	4CH, 5A/CH
Potencia de salida Output Power	4x120W
Tamaño Size	L175 x W45 x H27 mm
Distancia Distance	30M
Temperatura de trabajo Working Temperature	-30°C ~ +55°C
PVP	97,95€

Instalación:

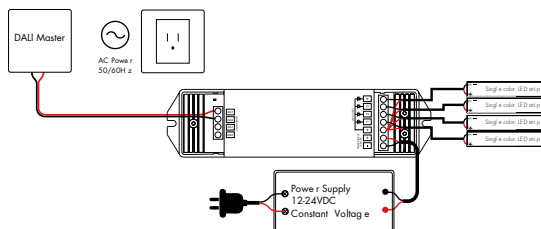

CONTROLADOR DALI A AC TRIAC 1,5A

Ref.: 88563

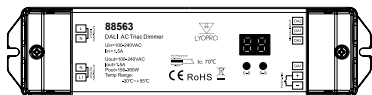

Tuya controlador DALI A AC TRIAC 1,5A | Tuya controlador DALI A AC TRIAC 1,5A

Control Input Signal	DALI
Voltaje de entrada Input Voltage	AC 100-240V
Tensión de salida Output Voltage	AC 100-240V
Corriente de salida Output Current	1CH, 1,5A
Potencia de salida Output Power	360W
Tamaño Size	L187 x W46 x H22 mm
Distancia Distance	30M
Temperatura de trabajo Working Temperature	-30°C ~ +55°C
PVP	98,95€

Instalación:

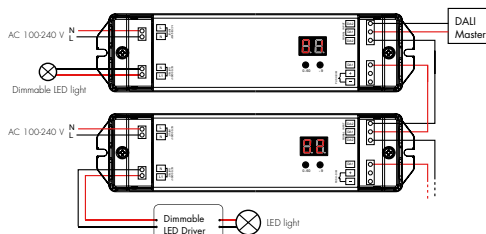

REGULADOR 0/1-10V PARA 1 LUMINARIA

Ref.: **88560**



Regulador 0/1-10V 1 luminaria | Regulador 0/1-10V 1 luminaria

Control <i>Imput Signal</i>	RF 2.4GHz+Push Dim
Voltaje de entrada <i>Imput Voltage</i>	AC100-240V
Corriente de salida <i>Output Current</i>	Max 1,5A
Salida de señal <i>Output signal</i>	0/1-10V (20mA)
Tamaño <i>Size</i>	L52 x W52 x H26 mm
Distancia <i>Distance</i>	30M
Temperatura de trabajo <i>Working Temperature</i>	-30°C~+55°C
PVP	68,95€

Instalación:

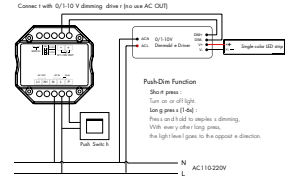

REGULADOR 0/1-10V PARA 4 LUMINARIAS

Ref.: **88561**



Regulador 0/1-10V 4 luminarias | Regulador 0/1-10V 4 luminarias

Control <i>Imput Signal</i>	RF 2.4GHz
Voltaje de entrada <i>Imput Voltage</i>	100-240VAC - 12VDC
Corriente de salida <i>Output Current</i>	4CH, 10mA/CH
Salida de señal <i>Output signal</i>	4x(0-10)VDC
Tamaño <i>Size</i>	L114 x W38 x H20 mm
Distancia <i>Distance</i>	30M
Temperatura de trabajo <i>Working Temperature</i>	-30°C~+55°C
PVP	79,95€

Instalación:

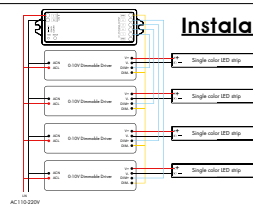

Aplicación:



REGULADOR 0/1-10V PARA 4 LUMINARIAS (REPETIDOR)

Ref.: **88562**



Regulador 0/1-10V 4 luminarias | Regulador 0/1-10V 4 luminarias

Control <i>Imput Signal</i>	RF 2.4GHz
Voltaje de entrada <i>Imput Voltage</i>	100-240VAC - 12VDC
Corriente de salida <i>Output Current</i>	0/1-10V: 20mA/CH Max 3A
Salida de señal <i>Output signal</i>	4X(0-10)VDC
Tamaño <i>Size</i>	L175 x W45 x H27 mm
Distancia <i>Distance</i>	30M
Temperatura de trabajo <i>Working Temperature</i>	-30°C~+55°C
PVP	109,95€

Instalación:

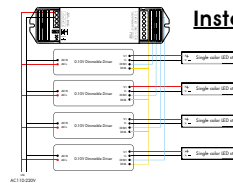

Aplicación:



REGULADOR 0/1-10V A AC TRIAC 2A

Ref.: **88568**



Regulador 0/1-10V A AC TRIAC 2A | Regulador 0/1-10V A AC TRIAC 2A

Control <i>Imput Signal</i>	RF+0/1-10V+AC Push
Voltaje de entrada <i>Imput Voltage</i>	AC 100-240V
Tensión de salida <i>Output Voltage</i>	AC 100-240V
Corriente de salida <i>Output Current</i>	Max 2A
Potencia de salida <i>Output Power</i>	480W
Tamaño <i>Size</i>	L175 x W45 x H27 mm
Distancia <i>Distance</i>	30M
Temperatura de trabajo <i>Working Temperature</i>	-30°C~+55°C
PVP	94,95€

Instalación:

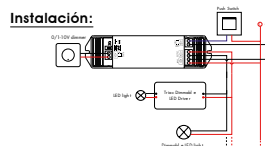

Aplicaciones:

Todos los receptores en la misma zona

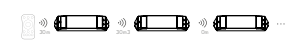

Cada receptor (uno o más) en una zona diferente, como la zona 1, 2, 3 o 4.



Caution: Never install more than one receiver in parallel with another receiver, making sure between the terminals of the dimmer.

SMART DRIVER REGULABLE 15A

Ref.: 88530



Control <i>Input Signal</i>	RF 2.4GHz+Push Dim
Voltaje de entrada <i>Input Voltage</i>	100-265VAC
Tensión de salida <i>Output Voltage</i>	10-45VDC
Corriente de salida <i>Output Current</i>	150-700mA
Potencia de salida <i>Output Power</i>	Max 15W
Tamaño <i>Size</i>	L51 x W41 x H30 mm
Distancia <i>Distance</i>	30M
Temperatura de trabajo <i>Working Temperature</i>	-30°C~+55°C
PVP	49,95€

Instalación:

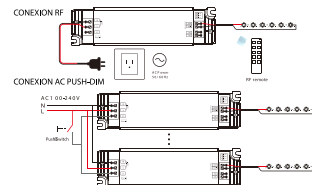

Aplicaciones:

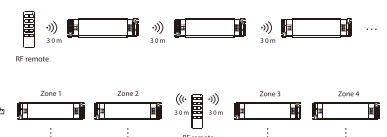

SMART DRIVER REGULABLE 36A

Ref.: 88532



Control <i>Input Signal</i>	RF 2.4GHz+Push Dim
Voltaje de entrada <i>Input Voltage</i>	100-265VAC
Tensión de salida <i>Output Voltage</i>	10-52VDC
Corriente de salida <i>Output Current</i>	350-1200mA
Potencia de salida <i>Output Power</i>	Max 36W
Tamaño <i>Size</i>	L168,5 x W44 x H30 mm
Distancia <i>Distance</i>	30M
Temperatura de trabajo <i>Working Temperature</i>	-30°C~+55°C
PVP	79,95€

Instalación:

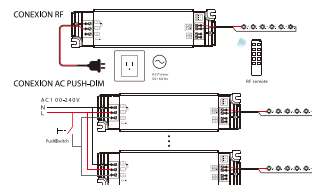

Aplicaciones:

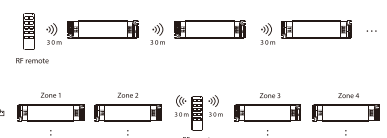

SMART DRIVER REGULABLE 50A

Ref.: 88533



Control <i>Input Signal</i>	RF 2.4GHz+Push Dim
Voltaje de entrada <i>Input Voltage</i>	100-265VAC
Tensión de salida <i>Output Voltage</i>	10-52VDC
Corriente de salida <i>Output Current</i>	500-1750mA
Potencia de salida <i>Output Power</i>	Max 50W
Tamaño <i>Size</i>	L133 x W88 x H30 mm
Distancia <i>Distance</i>	30M
Temperatura de trabajo <i>Working Temperature</i>	-30°C~+55°C
PVP	98,95€

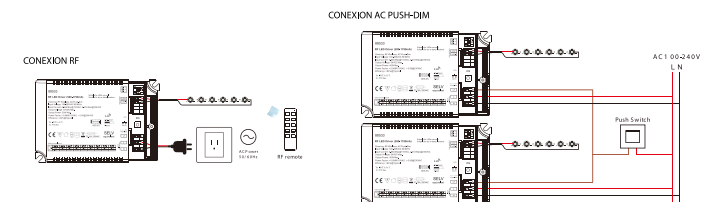

CONDICIONES GENERALES DE VENTA

FORMALIZAR UN PEDIDO IMPLICA LA ACEPTACIÓN DE ESTAS CONDICIONES DE VENTA GENERALES

Todas las ventas se realizan bajo las condiciones relacionadas a continuación. Cualquier especificación que no se ajuste a estas condiciones tendrá que ser antes aceptada por escrito por LYOPRO.

PRESUPUESTOS

Los presupuestos tendrán una validez máxima de 30 días naturales desde la fecha de su emisión.

GARANTÍA Y CALIDAD

Todos nuestros productos están garantizados (consultar en cada caso la ficha técnica en www.lyopro.es) contra cualquier defecto de fabricación. Esta garantía no cubre deterioros sufridos por el uso o aplicación indebida, incorrecta manipulación, una no correcta instalación cuando el producto haya sido usado fuera de su capacidad, maltratado, golpeado, así como cualquier otra falla atribuible al cliente o consumidor o cuando la falla sea original por el desgaste normal de las piezas debido a su funcionamiento o instalación. Queda fuera de garantía todo material manipulado por personal no autorizado por la empresa. Pequeñas diferencias entre nuestros productos en cuanto a tamaño, color, calidad o cualquier otra modificación en el producto, no serán motivo de reclamación por parte del comprador. Cualquier reclamación imputada en cuanto a cantidad, calidad u otros defectos serán comunicadas a LYOPRO, en un plazo máximo de 48 horas a la recepción de la mercancía, transcurrido este plazo no dará lugar a reclamación alguna. Para la ejecución de la garantía mediante abono o reposición es imprescindible recibir el material en cuestión para poder ser analizado y determinar que ésta procede. Requisito indispensable en toda garantía la presentación de factura y comprobante de pago y rellenando el RMA correspondiente. LYOPRO en continua mejora de la calidad y funcionalidad de sus productos se reserva el derecho a modificar o suprimir cualquiera de estos sin previo aviso sin que ello sea motivo de reclamación por parte del cliente.

PLAZO DE ENTREGA

Los plazos de entrega son sólo aproximados y sin compromiso, no admitiéndose demanda por daños y perjuicios por parte del cliente por demora de la entrega, ni otras demandas o indemnizaciones por incumplimientos contractuales. El incumplimiento del plazo de entrega no faculta al cliente a la rescisión del contrato de compra sin la concesión de un plazo prudencial de tiempo para solucionar dicha demora (importaciones de materiales y productos varios (60-90 días). Las causas de fuerza mayor (guerras, revoluciones, huelgas, catástrofes naturales, roturas de maquinaria, roturas de moldes o matrices, imposibilidad de adquisición de materia prima, interrupción del transporte, cierre de aduanas o cualquier otra medida oficial que pudiera afectar, etc.) nos da el derecho a demorar el plazo de entrega sin previo aviso. Cada operación es una expedición independiente, aunque varias de ellas formen parte de un mismo pedido.

PRECIOS / PORTES

Serán los establecidos en nuestra web a excepción de acuerdos explícitos confirmados por LYOPRO.

PORTES: Condiciones válidas únicamente en territorio peninsular español. Portes pagados a partir de 200€.

Islas Canarias: Portes pagados a partir de 600€. Debido a errores de imprenta, evolución de los productos o a las constantes fluctuaciones de la materia prima, LYOPRO se reserva el derecho de variar los precios sin previo aviso.

PEDIDOS

Todos los pedidos manipulados deberán confirmarse por escrito (devolviendo la hoja de pedido que se pase por correo electrónico) antes de que entren en funcionamiento. Todo pedido de fabricación y manipulación que supere los 1.500 € el cliente deberá abonar el 50% por adelantado antes del inicio de la fabricación (en concepto de reserva). En todos los pedidos de materiales que no hayan sido cursados por escrito (E-mail) LYOPRO no se hace responsable si hay disconformidad con lo que pidió y se sirvió. Ningún pedido cuya forma de pago sea transferencia entrará en funcionamiento antes de recibir el resguardo del pago.

ANULACIONES-DEVOLUCIONES DE PEDIDOS

No se aceptarán devoluciones transcurridos 15 días desde la entrega de material. Los pedidos pasados en firme no pueden ser anulados sin la conformidad de LYOPRO. En caso de devolución por causas ajenas a LYOPRO, el material será abonado con un 20% de demérito (con un mínimo de 10 €). No se aceptará ninguna devolución de materiales sin la autorización expresa de LYOPRO y con la hoja de devolución cumplimentada. De igual forma no se aceptará ninguna devolución a portes debidos si el motivo de dicha devolución es error de LYOPRO será LYOPRO quien envíe su agencia). No se aceptará responsabilidad ni reclamación alguna que sobrepase la reposición del material enviado o el pago de éste al precio al que fue adquirido. Ningún producto fabricado a medida ó traído expresamente para el cliente (que no se encuentre en stock habitual) será reembolsado, no teniendo derecho el cliente a reclamación alguna.

RESERVA DE PROPIEDAD

La mercancía suministrada queda en nuestra total propiedad hasta su pago. El derecho de propiedad subsiste aún después de que el comprador haya revendido el producto, hasta que no haya cancelado la deuda con LYOPRO.

TRANSPORTE

Cualquier anomalía del material recibido o incidencia del transporte deberá ser reflejada en el albarán que se firma al transportista o perderá el derecho a reclamación. El cliente deberá posteriormente darnos el aviso de la incidencia antes de las 24h posteriores a la entrega, no responsabilizándose en ningún caso si la reclamación es posterior a lo indicado. Es de competencia del cliente ejercer sus acciones con los transportistas en caso de pérdida, avería o retraso de la mercancía. El cliente tiene la obligación de examinar la mercancía en el momento de la entrega y anotar cualquier anomalía. No poner reparo en el talón o albarán de la agencia de transporte se entenderá que es de su conformidad. Si el cliente no ha dado instrucciones especiales de expedición, la mercancía se enviará según nuestro mejor parecer y por medio de transporte elegido por LYOPRO.

PAGO

Las condiciones de pago serán las acordadas con nuestros clientes. Los vencimientos de los pagos mediante cualquier documento de pago legalmente aceptado, deberán de respetarse puntualmente. En caso contrario estamos facultados a cargar los intereses de demora, así como los quebrantos ocasionados por la demora en el pago. Las demoras en el pago traen consigo con efecto inmediato la anulación de todos los compromisos de LYOPRO para con el cliente. El comprador no está autorizado a retener la totalidad a parte de los pagos vencidos por no habersele reconocido alguna reclamación, ya que ésta no le exime de su compromiso de pago. Todo impagado o retraso en el pago anula la posibilidad del crédito, paralizando el suministro de materiales en tanto no se regularice la situación. Si esta situación fuera repetitiva, se procederá a comunicarlo a CRÉDITO & CAUCIÓN cancelándose el crédito de forma irrevocable.

FUERO

Para cuantas cuestiones y discrepancias se deriven de la presente operación, comprador y vendedor se someten expresamente a la competencia de los jueces y tribunales de los Juzgados de Valencia con renuncia a cualquier otro fuero propio o reserva de dominio que pudiera corresponder.

COSTAS Y GASTOS

Los gastos y costas judiciales, incluso honorarios de Abogado y derechos de Procurador, serán siempre por cuenta de la parte contratante que hubiera dado lugar a ellos por incumplimiento de estas condiciones generales de venta o del contrato en general.

DERECHO SUPLETORIO

El presente contrato de venta se regirá por lo aquí convenido y en su defecto por las normas del Código de Comercio Español para las ventas en España.

TARIFA

Los precios se indican en las tarifas vigentes en cada momento y se complementan con las políticas comerciales correspondientes. Están sujetos a cambios sin previo aviso. El precio final de la facturación es franco desde nuestro almacén de VALENCIA. No incluyen portes, seguros, desplazamientos o gastos de instalación. Los productos especiales no incluidos en la lista de precios están sujetos a cotización mediante oferta escrita o factura proforma, en las condiciones que en la misma se determinen. No se tomarán en consideración acuerdos verbales sobre este punto.

GENERAL SALE CONDITIONS

FORMALIZING AN ORDER IMPLIES THE ACCEPTANCE OF THESE GENERAL CONDITIONS OF SALE

All sales are made under the conditions listed below. Any specification that does not conform to these conditions will have to be previously accepted in writing by LYOPRO.

OFFERS

Budgets will be valid for a maximum of 30 calendar days from the date of issue.

WARRANTY AND QUALITY

All our products are guaranteed (consult the technical sheet in each case at www.lyopro.es) against any manufacturing defect. This guarantee does not cover deterioration suffered by improper use or application, incorrect handling, incorrect installation when the product has been used beyond its capacity, mistreated, hit, as well as any other failure attributable to the client or consumer or when the failure is due to the normal wear and tear of the parts due to its operation or installation. Any material handled by personnel not authorized by the company is out of warranty. Small differences between our products in terms of size, color, quality or any other modification in the product will not be grounds for a claim by the buyer. Any claim made in terms of quantity, quality or other defects will be communicated to LYOPRO, within a maximum period of 48 hours upon receipt of the merchandise, after this period will not give rise to any claim. For the execution of the guarantee through payment or replacement, it is essential to receive the material in question in order to be able to analyze it and determine that it is appropriate. An essential requirement in any guarantee is the presentation of the invoice and proof of payment and filling in the corresponding RMA. LYOPRO in continuous improvement of the quality and functionality of its products reserves the right to modify or delete any of these without prior notice without this being a reason for a claim by the client.

DELIVERY TERM

Delivery times are only approximate and without obligation, not accepting claims for damages by the customer for delayed delivery, or other claims or compensation for breaches of contract. Failure to comply with the delivery period does not authorize the client to terminate the purchase contract without granting a reasonable period of time to solve said delay (imports of materials and various products (60-90 days). Force majeure (wars, revolutions, strikes, natural catastrophes, machinery breakage, mold or die breakage, impossibility of acquiring raw materials, transport interruption, customs closure or any other official measure that may affect, etc.) gives us the right to delay the delivery period without prior notice. Each operation is an independent expedition, even if several of them are part of the same order.

PRICES / SHIPPING

FREIGHT: The transport price conditions for outside Spain will be defined with the opening of each customer's file.

ORDERS

All orders for cut or manipulated material must be confirmed in writing (returning the order form sent by email) before they go into operation. Any order for manufacturing and handling that exceeds €1,500, the customer must pay 50% in advance before the start of manufacturing (as a reserve). In all requests for materials that have not been made in writing (E-mail) LYOPRO is not responsible if there is disagreement with what was requested and served. No order whose payment method is transfer will start working before receiving the receipt of payment.

CANCELLATIONS-RETURNS OF ORDERS

Returns will not be accepted after 15 days from the delivery of material. Firm orders cannot be canceled without the consent of LYOPRO. In case of return for reasons beyond LYOPRO's control, the material will be paid with a 20% demerit (with a minimum of €10). No return of materials will be accepted without the express authorization of LYOPRO and with the completed return sheet. In the same way, no return to postage due will be accepted if the reason for said return is a LYOPRO error, LYOPRO will be the one who sends its agency). No liability or claim will be accepted that exceeds the replacement of the material sent or the payment thereof at the price at which it was purchased. No product made to measure or brought expressly for the client (that is not in regular stock) will be reimbursed, and the client is not entitled to any claim. Any special order, made to measure, that has cuts, etc..., will not be refundable.

PROPERTY RESERVATION

The supplied goods remain our full property until paid for. The property right subsists even after the buyer has resold the product, until the debt with LYOPRO has been cancelled.

TRANSPORT

Any anomaly of the material received or incidence of transport must be reflected in the delivery note that is signed to the carrier or you will lose the right to claim. The client must subsequently notify us of the incident within 24 hours after delivery, not being responsible in any case if the claim is made after to the indicated. It is the responsibility of the client to exercise their actions with the carriers in case of loss, breakdown or delay of the merchandise. The client has the obligation to examine the merchandise at the time of delivery and note any anomalies. Not objecting to the check or delivery note of the transport agency will be understood to be in accordance with it. If the client has not given special shipping instructions, the merchandise will be sent according to our best opinion and by means of transport chosen by LYOPRO.

PAYMENT TERMS

The payment terms will be those agreed with our clients. Payment due dates through any legally accepted payment document must be respected promptly. Otherwise, we are entitled to charge late-payment interest, as well as losses caused by late payment. Delays in payment bring with immediate effect the cancellation of all LYOPRO commitments to the client. The buyer is not authorized to withhold all or part of the overdue payments for not having recognized any claim, since this does not exempt him from his commitment to pay. Any non-payment or delay in payment annuls the possibility of credit, paralyzing the supply of materials until the situation is regularized. If this situation is repetitive, it will proceed to notify CREDIT & SURETY, canceling the credit irrevocably.

JURISDICTION

For any questions and discrepancies arising from this operation, buyer and seller expressly submit to the jurisdiction of the judges and courts of the Courts of Valencia, waiving any other jurisdiction or reservation of ownership that may correspond.

COSTS AND EXPENSES

Legal expenses and costs, including attorney's fees and Attorney's rights, will always be borne by the contracting party that would have given rise to them due to breach of these general conditions of sale or of the contract in general.

SUPPLEMENTARY RIGHT

This sales contract will be governed by what is agreed herein and, failing that, by the rules of the Spanish Commercial Code for sales in Spain.

CONDITIONS GENERALES DE VENTE

LA FORMALISATION D'UNE COMMANDE IMPLIQUE L'ACCEPTATION DES PRESENTES CONDITIONS GENERALES DE VENTE

Toutes les ventes sont faites dans les conditions énumérées ci-dessous. Toute spécification non conforme à ces conditions devra être préalablement acceptée par écrit par LYOPRO.

DEVIS

Les budgets seront valables pendant un maximum de 30 jours calendaires à compter de la date d'émission.

GARANTIE ET QUALITÉ

Tous nos produits sont garantis (consultez la fiche technique dans chaque cas sur www.lyopro.es) contre tout défaut de fabrication. Cette garantie ne couvre pas les détériorations subies par une mauvaise utilisation ou application, une mauvaise manipulation, une mauvaise installation lorsque le produit a été utilisé au-delà de ses capacités, maltraité, heurté, ainsi que toute autre défaillance imputable au client ou au consommateur ou lorsque la défaillance est due à l'usure normale des pièces due à son fonctionnement ou à son installation. Tout matériel manipulé par du personnel non autorisé par l'entreprise est hors garantie. Les petites différences entre nos produits en termes de taille, de couleur, de qualité ou toute autre modification du produit ne pourront donner lieu à réclamation de la part de l'acheteur. Toute réclamation formulée en termes de quantité, qualité ou autres défauts sera communiquée à LYOPRO, dans un délai maximum de 48 heures à réception de la marchandise, passé ce délai ne pourra donner lieu à aucune réclamation. Pour l'exécution de la garantie par paiement ou remplacement, il est indispensable de recevoir le matériel en question afin de pouvoir l'analyser et déterminer s'il est approprié. Une exigence essentielle de toute garantie est la présentation de la facture et de la preuve de paiement et le remplissage du RMA correspondant. LYOPRO dans l'amélioration continue de la qualité et de la fonctionnalité de ses produits se réserve le droit de modifier ou de supprimer l'un quelconque de ceux-ci sans préavis sans que cela puisse constituer un motif de réclamation de la part du client.

DÉLAI DE LIVRAISON

Les délais de livraison ne sont qu'approximatifs et sans engagement, n'acceptant pas les demandes de dommages-intérêts du client pour retard de livraison, ou d'autres réclamations ou compensations pour rupture de contrat. Le non-respect du délai de livraison n'autorise pas le client à résilier le contrat d'achat sans accorder un délai raisonnable pour résoudre ledit retard (importations de matériels et produits divers (60-90 jours). Force majeure (guerres, révolutions, grèves, catastrophes naturelles, bris de machines, bris de moule ou de matrice, impossibilité d'acquérir des matières premières, interruption de transport, fermeture douanière ou toute autre mesure officielle pouvant affecter, etc.) nous donne le droit de retarder le délai de livraison sans préavis. Chaque opération est une expédition indépendante, même si plusieurs d'entre elles font partie du même ordre.

PRIX / LIVRAISON

FRET: Les conditions du prix du transport pour l'extérieur de l'Espagne seront définies à l'ouverture du dossier de chaque client.

ORDRES

Toute commande de matériel découpé ou manipulé doit être confirmée par écrit (renvoi du bon de commande envoyé par mail) avant sa mise en service. Toute commande de fabrication et de manutention supérieure à 1 500 €, le client doit régler 50 % d'avance avant le début de la fabrication (à titre de réserve). Dans toutes les demandes de matériel qui n'ont pas été faites par écrit (E-mail), LYOPRO n'est pas responsable en cas de désaccord avec ce qui a été demandé et servi. Aucune commande dont le mode de paiement est le virement ne commencera à fonctionner avant la réception du paiement.

ANNULATIONS-RETOURS DE COMMANDES

Les retours ne seront pas acceptés après 15 jours à compter de la livraison du matériel. Les commandes fermes ne peuvent être annulées sans l'accord de LYOPRO. En cas de retour pour des raisons indépendantes de la volonté de LYOPRO, le matériel sera payé avec un démerite de 20% (avec un minimum de 10€). Aucun retour de matériel ne sera accepté sans l'autorisation expresse de LYOPRO et avec le bordereau de retour complété. De même, aucun retour en port dû ne sera accepté si le motif dudit retour est une erreur LYOPRO, LYOPRO sera celui qui envoie son agence). Aucune responsabilité ou réclamation ne sera acceptée au-delà du remplacement du matériel envoyé ou de son paiement au prix auquel il a été acheté. Aucun produit fabriqué sur mesure ou apporté exprès pour le client (qui n'est pas en stock régulier) ne sera remboursé, et le client ne pourra prétendre à aucune réclamation. Toute commande spéciale, sur mesure, comportant des découpes, etc..., ne sera pas remboursable.

RÉSERVATION DE PROPRIÉTÉ

Les marchandises livrées restent notre entière propriété jusqu'au paiement. Le droit de propriété subsiste même après que l'acheteur a revendu le produit, jusqu'à ce que la dette envers LYOPRO ait été annulée.

TRANSPORT

Toute anomalie du matériel reçu ou incidence du transport doit être mentionnée sur le bon de livraison qui est signé au transporteur ou vous perdrez le droit de réclamer. Le client doit ensuite nous signaler l'incident dans les 24 heures suivant la livraison, n'étant en aucun cas responsable si la réclamation est faite après à l'indiqué Il appartient au client d'exercer ses recours auprès des transporteurs en cas de perte, panne ou retard de la marchandise. Le client a l'obligation d'examiner la marchandise au moment de la livraison et de relever toute anomalie. Ne pas contester le chèque ou le bon de livraison de l'agence de transport sera considéré comme conforme à celui-ci. Si le client n'a pas donné d'instructions d'expédition particulières, la marchandise sera expédiée selon notre meilleur avis et par le moyen de transport choisi par LYOPRO.

CONDITIONS DE PAIEMENT

Les conditions de paiement seront celles convenues avec nos clients. Les dates d'échéance de paiement via tout document de paiement légalement accepté doivent être respectées rapidement. Dans le cas contraire, nous sommes en droit de facturer des intérêts de retard, ainsi que les pertes causées par un retard de paiement. Les retards de paiement entraînent avec effet immédiat l'annulation de tous les engagements de LYOPRO envers le client. L'acheteur n'est pas autorisé à retenir tout ou partie des retards de paiement pour n'avoir reconnu aucune créance, dès lors que cela ne le dispense pas de son engagement de payer. Tout non-paiement ou retard de paiement annule la possibilité de crédit, paralysant l'approvisionnement en matériaux jusqu'à ce que la situation soit régularisée. Si cette situation est répétitive, il procédera à la notification de CREDIT & SURETY, annulant irrévocablement le crédit.

JURIDICTION

Pour toutes questions et divergences découlant de cette opération, l'acheteur et le vendeur se soumettent expressément à la compétence des juges et des tribunaux des tribunaux de Valence, renonçant à toute autre juridiction ou réserve de propriété qui pourrait correspondre.

COÛTS ET DÉPENSES

Les frais et dépenses judiciaires, y compris les honoraires et droits d'avocat, seront toujours à la charge du cocontractant qui les a engendrés du fait de la violation des présentes conditions générales de vente ou du contrat en général.

DROIT SUPPLÉMENTAIRE

Ce contrat de vente sera régi par ce qui est convenu ici et, à défaut, par les règles du Code de commerce espagnol pour les ventes en Espagne.

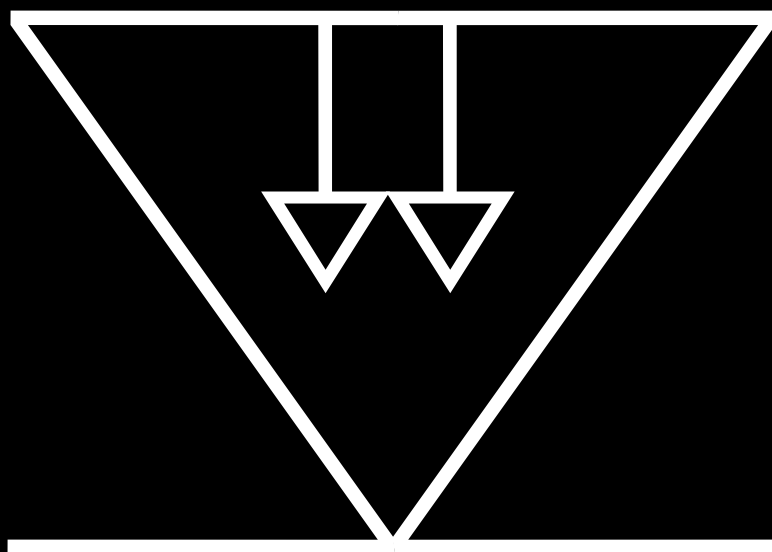

Lighting with you

Síguenos en:

Follow us:

Suivez nous:



Lighting Products S.L.

C/. 32, 130 Pol. Ind. El Bony
46470 CATARROJA (VALENCIA)

Telf. 96 118 11 38

Mail: info@lightingproducts.es

www.lyopro.es