



Catalogue
2020/21



COLLINGWOOD
LIGHTING



1901
BY COLLINGWOOD
LIGHTING
3000K, >90CRI

Collingwood founded in 1901.

A British designer & manufacturer of LED lighting products

Collingwood started designing innovative LED lighting products in 2002. We pride ourselves on creating beautifully designed products that are easy to install and highly energy efficient. Using top quality materials, our products come with long warranties and are backed up by our expert UK based customer service team. With a next day delivery policy within the UK, we are always prepared to go the extra mile to ensure our customers receive excellent service and superior quality products.

This philosophy has led us to introduce many firsts to the LED lighting market.



First to design and manufacture

LED lighting products for the UK electrical wholesale market.



First to produce 100% waterproof

Sealed for life, 100% waterproof, inground LED lighting products.



First outdoor LED products

Produce sealed for life outdoor LED lighting products.



First for fire rated downlights

First to produce a fit for purpose, high performance, fire-rated LED downlight.



First to produce mains dimmable

Mains dimmable LED downlights.



First to comply with building regulations

First to produce an LED downlight that complies with all building regulations.



First to create a 360° downlight

Produce a fire, acoustic and moisture-rated 360° spherical style downlight.



First to offer extended warranty

First to offer a 7 year extended warranty. We now offer a 3, 4, 5, & 7 year extended warranty.

You can register online by visiting collingwoodlighting.com or by contacting the sales team on 01604 495151. A full list of eligible products can also be found on our website. All applications, once accepted and processed will receive confirmation and a unique reference number in the event of a claim. All products come with a guarantee for 12 months from purchase, unless otherwise stated. Any modifications made to our products may invalidate the warranty.

An introduction to Collingwood.

We design and manufacture innovative, high quality LED lighting products.

We are designers and makers – insightful, agile and inventive. We are committed to seeking the most effective way of doing things, to making brilliant products, to deliver outstanding service and to be the first and best choice for our customers.

At Collingwood Lighting, our drive and determination to provide excellence for our customers pushes us to challenge the boundaries of the lighting industry. We believe that each stage of the lighting process is crucial to creating awe-inspiring lit environments and dedicate ourselves to each step.

Design and planning

From the outset, we collaborate with our customers to design beautifully lit, energy efficient spaces. We provide a wealth of resources to aid in maximising the potential of any space including case studies, guides and an exceptional lighting design team.

Streamlining installation

We regularly develop innovative solutions to make the installation of our products quicker and easier for our customers and their teams. Starting with our team of engineers who improve every aspect of our products, through to our video guides, customer training and a highly skilled sales and technical team, we aim to make the installation as streamlined as possible.

Customer care excellence

We know that one of the key considerations when completing a project for your customers is peace of mind after completion. To this end, we offer extended warranties, after care guides and a brilliant customer service team who are only a phone call away.





Contents.

04 | **Introduction**

- 04 | An introduction to Collingwood
- 06 | New products
- 18 | Coming soon
- 31 | Collingwood drivers
- 32 | Inspiration

66 | **Smart**

- 68 | What can be achieved
- 74 | Products

76 | **Residential**

- 78 | Residential downlights
- 114 | Architectural downlights
- 136 | Decorative wall lights and undershelf lighting

300 | **Commercial**

- 302 | Panels
- 308 | Commercial downlights
- 316 | Retail lighting

332 | **Bulkheads**

- 334 | Bulkheads
- 338 | Bulkhead bezels

340 | **Industrial**

- 344 | High bays
- 350 | Low bays
- 356 | Floodlights
- 362 | Anti-corrosives



156

Strip lights

- 162 Profiles and accessories
- 168 LED strip

188

Residential floodlights

- 190 Floodlights

198

Landscape

- 202 Ground lights
- 238 Step lights
- 248 Wall lights
- 262 Pond lights
- 266 Uplights
- 278 Spike lights
- 292 Bollards

370

Colour change

- 384 Ground lights
- 393 Wall lights
- 394 Pond lights
- 396 Uplights
- 399 LED strip
- 402 Controls and accessories

402

Control & accessories

- 406 LED drivers
- 422 Accessories

424

Information

- 424 Explanation of terms
- 425 Information
- 431 Product range index
- 444 Alphabetical index



New smart lighting range.

Make the ordinary extraordinary with the Collingwood smart system. The new range of products combine with existing lighting in the home integrating them into the smart home system. A wide range of control options become available at the touch of a button, within the free-to-download CWD Smart app, or with voice command via a voice assistant. Explore our range of products later in the catalogue, starting on page 66, which includes bridges, dimmers, lamps and more.

Smart hub

Page 74

Connect your smart products to the WiFi and create / control striking environments from your phone anywhere in the world.



Dimmable bridge

Page 74

The dimmable bridge is for installation into the ceiling void, at the first leg of the circuit. The bridge can turn dimmable lights, smart.



Non dimmable bridge

Page 74

The non-dimmable bridge has been created for use with our landscape lighting range. Install this within an IP rated box, if outside, to turn outdoor lighting, smart.



Smart plug

Page 75

The smart plug is ideal for use for floor lamps, but isn't restricted to lighting. Use this to control anything that is inserted into a standard socket.



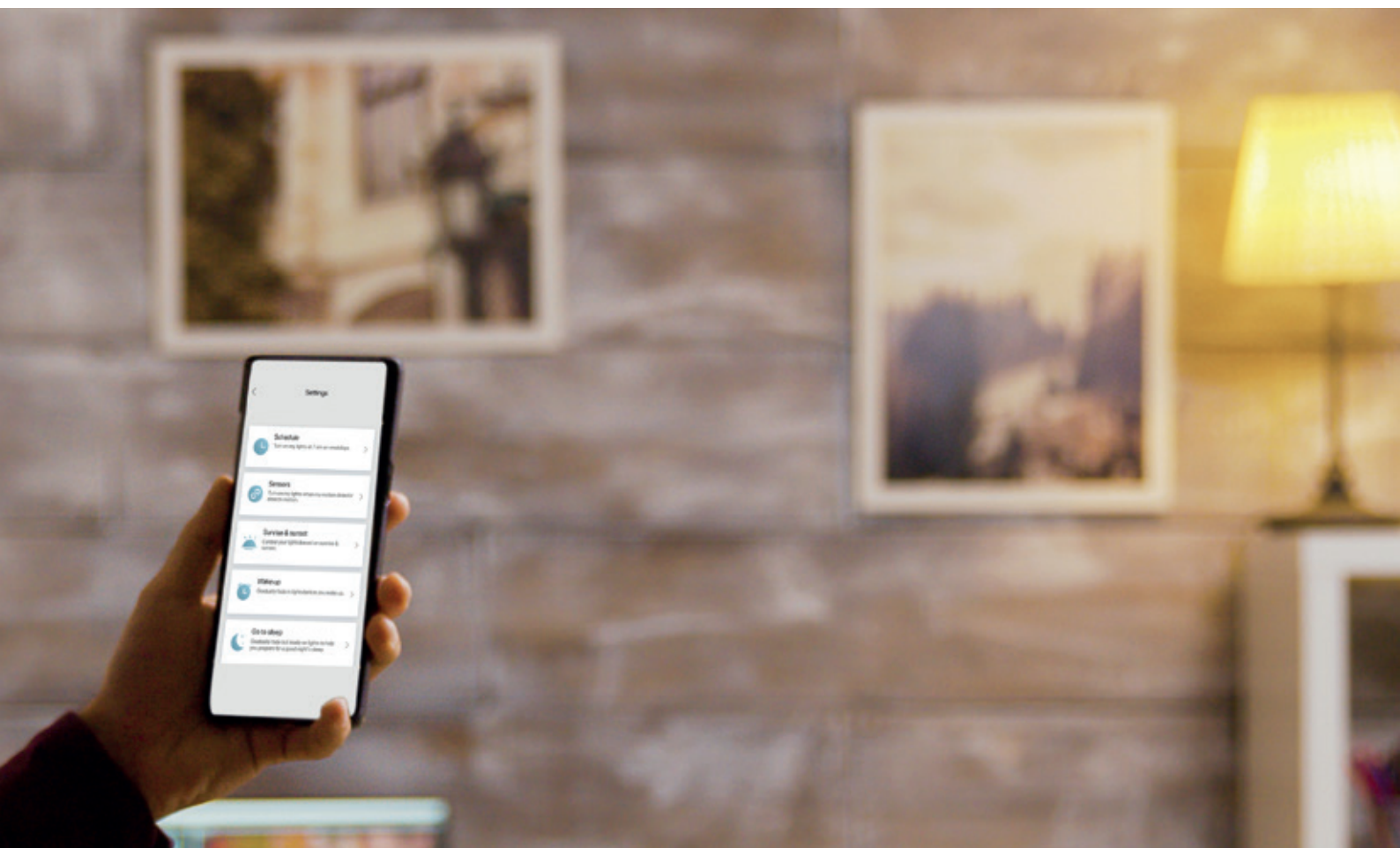

Smart B22

Page 75

Choose between:
Dimmable
Colour tuneable
RGBW



Smart E27

Page 75

Choose between:
Dimmable
Colour tuneable
RGBW



Smart GU10

Page 75

Choose between:
Dimmable
Colour tuneable
RGBW





New H4 Lite.

We have added the H4 Lite as an adjustable option to our Lite range of downlights. A true family look and feel can now be created through a combination of the fixed H2 Lite and adjustable H4 Lite in the same installation. Three finishes are available: Matt White, Brushed Steel and Chrome. The Easy-fit connector has been added as standard which ensures that installation is simple. At over 100lm/W, these fittings provide a low lifetime running cost and maximise energy efficiency.

H4 Lite

Page 88

The H4 Lite is an adjustable addition to our lite downlight range. With bezel & Easy-fit connector.

4.4W | IP65 | 4 year warranty



Available in Chrome, Brushed Steel and Matt White:



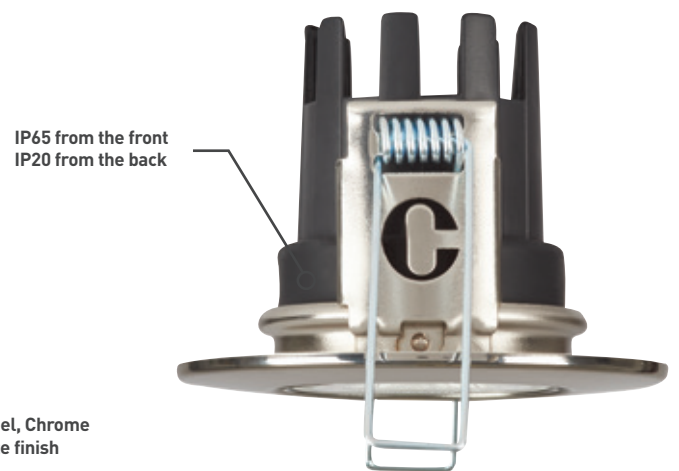
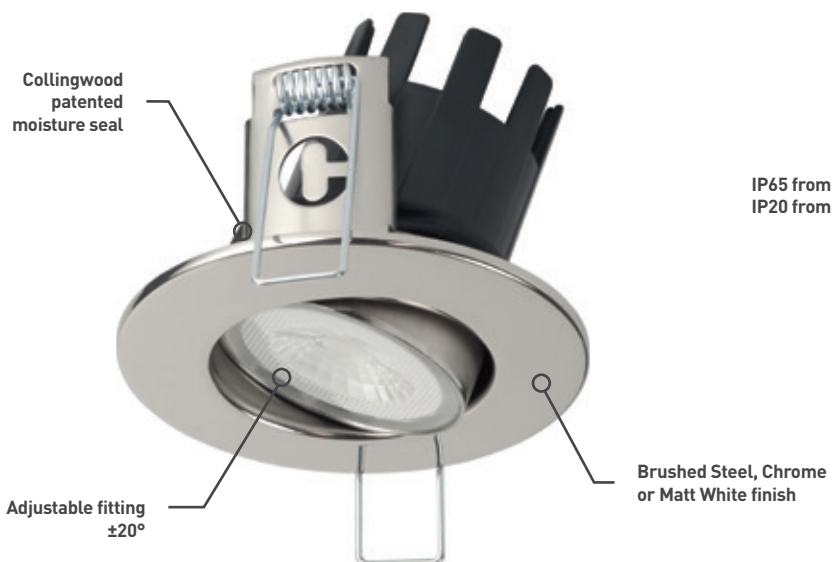



New 1901 slim round bezel.

We have introduced new slimline bezel options to complement the 1901 product range. At a diameter of just 75mm, this slimline bezel provides a low-profile discreet finish, ideal for minimalistic lighting designs for high-end interiors.



Slimline Bezel - Page 118

Standard Bezel



New Solis.

Our new range of back-lit LED panels are an ideal lighting solution for commercial areas such as offices, shops and receptions; they can also be used in education establishments such as schools and universities. At a high efficacy of 110lm/W and 4000K the Solis range is the ideal choice for commercial spaces. Available in three different sizes and a choice of UGR19 or UGR22. The range has a LED lifetime of 50,000 hours, IP40 rated and backed with Collingwood’s guarantee of five years.

Solis 600x600

Page 304

The Solis range brings all the benefits of LED lighting to a conventional ceiling panel design.

Back-lit | IP40 | 5 year warranty



Solis 1200x600

Page 305

The Solis range brings all the benefits of LED lighting to a conventional ceiling panel design.

Back-lit | IP40 | 5 year warranty



Solis 1200x300

Page 306

The Solis range brings all the benefits of LED lighting to a conventional ceiling panel design.

Back-lit | IP40 | 5 year warranty





New SL250 path light.

The SL250 is a sleek and contemporary path light. Offering a 360° illumination for high versatility to bring warm light to any path or corner of outdoor space. The SL250 path light gives an elegant halo glow, and minimal up spill of light so desired features can be highlighted in a 360° illumination. It is IP65 to withstand the outdoor elements, along with benefiting from low power consumption and has a seven-year extended warranty available. The SL250 is available in black, brass and copper finishes and three separate colour temperatures of 2700K, 3000K and 4000K. Used in conjunction with 24V drivers, supplied separately.

SL250

Page 290

With 360° illumination, the SL250 provides flexible landscape illumination for areas such as paths and flowerbeds.

4W | IP65 | 7 year warranty



Available in copper, bronze and black





New GLA01 square converter.

Collingwood's new square converter is the perfect accessory to change the look of ground lights. The GLA01 transforms a round ground light to a square ground light. Made from 316 stainless steel, it can withstand the harshest of outdoor environments, including tough coastal conditions. As well as it being used to change the look, it can be functional as an adapter plate too. This allows ground lights to be installed where the cut out maybe greater in diameter. It comes with the Collingwood guarantee of a seven-year extended warranty for added peace of mind.

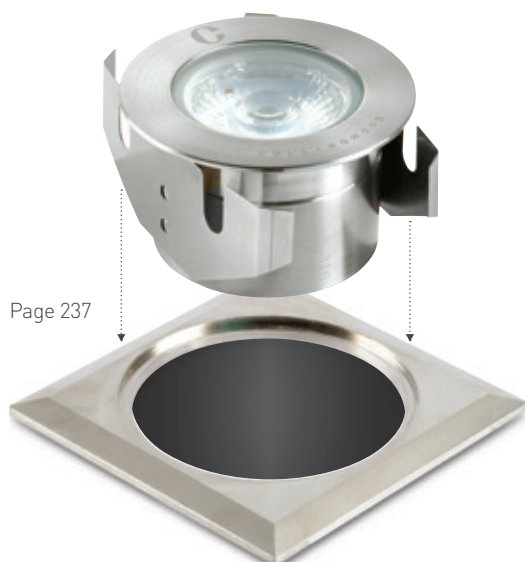

Use in conjunction with:



GL040
Also compatible
with RGB and low
glare versions



GL050
Also compatible
with RGBW
version



GL090
Also compatible
with RGBW
version



New Springbok high bays.

The Springbok high bay are the staple of industrial lighting and are 1-10V dimmable as standard. The black Magnesium alloy design allows for excellent heat dissipation for thermal management, resulting in a five year warranty being as standard. Combine this with a CRI of 80+ and efficacy of 140 lm/W, we can provide peace of mind that our products will provide excellent cost savings with short pay back periods and minimal need for replacement over the duration of the lifetime. A range of accessories are available such as reflectors, refractors and a sensor (working up to a maximum of 15m height) – allowing an effective lighting design to be created for the specific need.

Springbok 200W

Page 358

With an IP65 rating these high bays can be used outdoors and built for the toughest of indoor environments.

4000K | IP65 | 5 year warranty



Springbok 150W

Page 359

With an IP65 rating these high bays can be used outdoors and built for the toughest of indoor environments.

4000K | IP65 | 5 year warranty



Springbok 100W

Page 360

With an IP65 rating these high bays can be used outdoors and built for the toughest of indoor environments.

4000K | IP65 | 5 year warranty





New Lentus low bays.

The Lentus low bay, or linear high bay, is specifically designed for use in aisle spaces. A range of mounting options allows excellent flexibility on installation and with the five year warranty and a high 150 lm/W, provides the peace of mind. On site replaceable lenses change the beam angle if the warehouse aisle configuration changes over time and the sensor accessory available adds extra cost saving elements – ensuring the lights are on when required.

Lentus 150W

Page 352

Offering a colour temperature of 4000K, making it ideal for industrial use with high ceilings.

4000K | IP40 | 5 year warranty



Lentus 100W

Page 353

Offering a colour temperature of 4000K, making it ideal for industrial use with high ceilings.

4000K | IP40 | 5 year warranty





New K2 industrial floodlights.

With our range of industrial lighting, these K2 floodlights are durable and versatile, perfect for large-scale industrial settings that require suitable lighting whilst keeping costs down. Boasting a market-leading efficacy of 114lm/W savings in both energy and cost. There's a choice of output of 100W, 150W or 200W and beam angles of 120° or 100°x150° illuminate workspaces in either 3000K or 4000K. Like the rest of the industrial range, the K2 Floodlights come with a lifetime of up to 50,000 hours, backed by an extended five year warranty.

K2 200W

Page 358

Providing optimal protection against water these new range of floodlights are ideal for car parks and outside units.

3000K | IP65 | 5 year warranty
4000K | IP65 | 5 year warranty



K2 150W

Page 359

Providing optimal protection against water these new range of floodlights are ideal for car parks and outside units.

3000K | IP65 | 5 year warranty
4000K | IP65 | 5 year warranty



K2 100W

Page 360

Providing optimal protection against water these new range of floodlights are ideal for car parks and outside units.

3000K | IP65 | 5 year warranty
4000K | IP65 | 5 year warranty





New Caiman anti-corrosives.

We are excited to announce the addition of anti-corrosives to our industrial range. Enabling Collingwood to provide high quality lighting solutions to even more environments requiring a light that is as tough as its surroundings. Boasting an IP65 rating, Caiman is impact, water and dust resistant, making it perfect for the most hostile environments. Its robust exterior protects the superior LED technology within, allowing it to stand the test of time whilst providing excellent energy savings.

6ft Single & Twin

Page 364-365

With its tough exterior shielding against water, dust and impact this new range is ideal for car parks, industrial spaces and production areas.

4000K | IP65 | 5 year warranty



5ft Single & Twin

Page 366-367

With its tough exterior shielding against water, dust and impact this new range is ideal for car parks, industrial spaces and production areas.

4000K | IP65 | 5 year warranty



4ft Single & Twin

Page 368-69

With its tough exterior shielding against water, dust and impact this new range is ideal for car parks, industrial spaces and production areas.

4000K | IP65 | 5 year warranty



Coming soon



Coming soon

Battens.

Bringing further versatility to the commercial offering at Collingwood, our forthcoming range of IP20 Battens will provide an effective lighting solution to various commercial spaces. The streamlined linear fixture, available in three lengths, allows you to create a uniform installation of perfectly distributed light. Designed with the installer in mind, this range is quick and easy to fit, keeping use of tools to a minimum. It also provides various wiring options particularly useful in retrofit applications, of which it delivers excellent payback.



Coming soon

Emergency range.

Comprising the latest technology, we will provide a comprehensive range of emergency exit lighting. The range will include a bulkhead, box, blade, escape route light and twin spot. This range will fit seamlessly alongside our panels, commercial downlights, and industrial products to allow a full Collingwood lighting design and fit out.

Coming soon



Coming soon

New LED strip.

LED strip is a fast moving market and we are always innovating and offering new solutions. Our renewed and refreshed range will offer new ranges of LED strip with up-to-date, modern, features and benefits. Additionally, we are expanding our range of aluminium profiles and connectors to be able to offer both the widest selection of LED strip and versatility in mounting options, so that the desired lighting effects can be achieved.



Coming soon

New bulkheads.

Complementing our existing range, we have designed bulkheads to suit numerous different applications by offering different CCTs and wattages in one single product. Complemented by motion sensors and emergency models. For indoors, our stylish, highly efficient IP44 bulkhead brings comfort to any ambient due to its smartly designed diffuser, being a truly cost-effective lighting solution. Additionally, we added features making the installation simple and quick, saving time and reducing costs. For external applications, we have developed a slim IP65 bulkhead. Combining strength with elegance, this waterproof fixture boasts the robust exterior of its counterparts whilst enduring the most extreme outdoor conditions.

Coming soon



Coming soon

Stainless steel twin bar & spike.

We are introducing a new stainless steel models to our range of twin bar and pole spike lights. They are already available in bronze and black anodised aluminium we have brought to the market a durable 316 stainless steel, perfect for coastal environments. These spike lights are for perfect illumination of pathways, features and trees. Features include IP65 rating for outdoor use, efficacy of 144lm/W, tiltable up to 90° and rotatable up to 330° for flexible installation.



Coming soon

Deck lights.

We will be kicking-off garden lighting season with the introduction of our new deck light kits. These are available in packs of 5 or 10 pieces. They are made from stainless steel 304 and include a frosted lens to reduce glare, making these ideal for decking or patio areas. 1m and 2m extension kits are also available to extend the cable runs. These deck lights are compatible with our 24V range of drivers.

Coming soon



Coming soon

Midi ground light.

The GL045, our midi ground light, is ideal for pathways, driveways and gardens. Unlike the rest of our ground light range this is suitable for a cut-out size of 117mm.



Coming soon

Drive over ground light.

The GL06 is made from 316 stainless steel, making it suitable for coastal use and is backed with a five year extended warranty. Features include a 20° beam angle, along with an LED life of 30,000 hours at 3000K.

Coming soon



Coming soon

New 'welcome' wall lights.

Designed to illuminate terraces, facades and doorways, this new range of black anodised wall lights come in a variety of different styles, with different beam angles and provide a warm inviting entrance to porches and doorways.



Coming soon

New bollards.

We have extended and modernised our range of bollards, with some black anodised aluminium additions. The new bollards come in a variety of sizes and styles to suit a variety of different residential and commercial areas, such as car parks, driveways, gardens and much more. The new range is low glare with minimum light up spill, making it both functional and comfortable on the eye. SKUs are straight to mains in 3000K and backed with a five year warranty.

Coming soon



Coming soon

H5 500 & H5 1000 upgrade.

The H5 500 and 1000 range are being upgraded and brought into the new decade with the very latest LED technology, features and benefits. The new range of products will be adjustable by +/- 20° to remove the need for a symmetric and asymmetric version and make specification easy. Additionally, the fittings will be colour switchable with 2700K, 3000K and 4000K built in and changed via a switch, as well as being UGR<19. DALI and 1-10V dimming capability will be added, alongside mains dimming, and there will be an emergency option.



Coming soon

PSIP driver range.

We have redesigned our range of IP65 rated drivers that are used with our low voltage landscape products. 350mA and 700mA options are available and wattage range has been extended to allow for more fittings per driver. The drivers also now come with an increased warranty of five years.

I-Joist approved

Our downlights have undergone vigorous testing to ensure they are perfect for use with i-joists.



Vigorously tested to ensure fit-for-purpose products

Collingwood were the first company to produce a fit-for-purpose, high performance, fire-rated downlight that enabled compliance to Part B of the building regulations. In the period since, we have supplied millions of downlights worldwide.

We have worked, together with our independent partner in the UK, to test and approve our most popular fire-rated downlights for use with timber I-Joists, complementing our suite of solid timber ceiling approvals.

Which ceiling systems are approved for use?

Floor constructions which are made using wooden I-Joists with the following specification:

- James Jones 220mm deep I-Joists.
- 45mm x 47mm flanges.
- 9.2mm thick OSB board.
- Positioned at 600mm centres.
- Covered with 22mm tongue and groove chipboard flooring.
- 15mm British Gypsum Gyproc type A wallboard.

Driving performance.

Optimise performance with Collingwood drivers



**Collingwood
low voltage
luminaire**



**Collingwood
driver**



**Collingwood
performance**

Enhance the performance of Collingwood luminaires by combining them with our **carefully selected drivers.**

At Collingwood Lighting, high quality performance is at the core of everything we do. We strive for perfection and customer peace of mind not only at each stage of the installation process, but long into the future lifetime of the products.

Each of our LED lights are built with this in mind; our team of engineers spend countless hours researching and testing each one to ensure optimum performance and lifetime and a minimal failure rate. Not only are they built to make indoor and outdoor installations look incredible, but each component is rigorously engineered and tested to create a robust, quality product.

This ethos extends to our range of drivers. Our drivers are chosen based on their ability to enhance the individual fitting, after each one has undergone a stringent testing process to ensure optimum performance when used in combination with its light fitting counterparts.

When selecting lights for a project, Collingwood LED lights are chosen for their superior quality and reliable lifetime. To ensure they meet their full potential, **choose a Collingwood driver** that's been hand-selected to boost each product.

Refer to each individual product page for a list of compatible drivers or see the driver section for a full matrix of each driver and its compatible products. Alternatively, when planning an installation speak to our team who'll be happy to advise a complete driver solution.

Layering light.

Collingwood's range of residential lighting provides a comprehensive set of options to create your desired lighting schemes. Combine the key elements of the lighting, ambient, accent and task lighting, to create a sophisticated, multi-layered scheme which will enhance the space, bringing it to life and allowing the user to create a multitude of different atmospheres, depending on their requirements.

These layers can be broken down into different types:

- **Ambient lighting**
- **Accent lighting**
- **Task lighting**
- **High-level lighting**
- **Mid-level lighting**
- **Low-level lighting**

It is not necessary for an installation to include all types of lighting for it to be successful. However, by using a combination of these, it is possible to create exciting environments that people really want to spend time in.



1 Ambient lighting

Ambient lighting serves as the primary source of light in a space, providing general background illumination.

2 Accent lighting

Accent lighting, rather than being practical, provides points of focus, highlight and visual interest which add depth and interest to a space.

3 Task lighting

Task lighting is focused light for specific areas where tasks are carried out.

THE STUDIO

AT COLLINGWOOD

At The Studio, our team of professional lighting designers, who benefit from over 20 years of experience and lighting knowledge, can provide a bespoke lighting design for your project. To ensure you receive the highest level of service and expert advice, we work directly with you and also with architects, interior designers, landscape designers and more.

As well as producing simple lux level calculations, with their passion and flair for producing creative and effective lighting solutions, our design team is equipped to propose and present a full lighting solution for your project, including 3D visuals of the space.

The Studio offers three levels of design service, from a free of charge concept presentation to a chargeable CAD service which extends to full working drawings covering the lighting scheme. The level of service you require will depend on the complexity of your project. The design team at thestudio@collingwoodgroup.com is happy to discuss this with you.



4 High-level lighting

Ceiling lights and high-level up-light often provide ambient light. In a garden, lighting tall trees provides height to a lighting scheme.

5 Mid-level lighting

Wall lights, under cupboard lights, lamps and lit shelving or niches all contribute to an intermediate layer of light. In the garden, wall lights and spike lights highlighting shrubs work well.

6 Low-level lighting

Lights at ground level or set low in walls and kickboards provide low level mood lighting. The same is true outside, with lit paths and steps providing low-level guide lighting.



Recreate this look.

1 UL346CARGB
Page 397



2 UL030RGBW
Page 394







Recreate this look.

1 WL075
Page 253







Recreate this look.

1 LEDLINE 400 45
Page 274



2 LEDLINE 400 25X6
Page 271



3 GL090
Page 208



4 GL08
Page 205





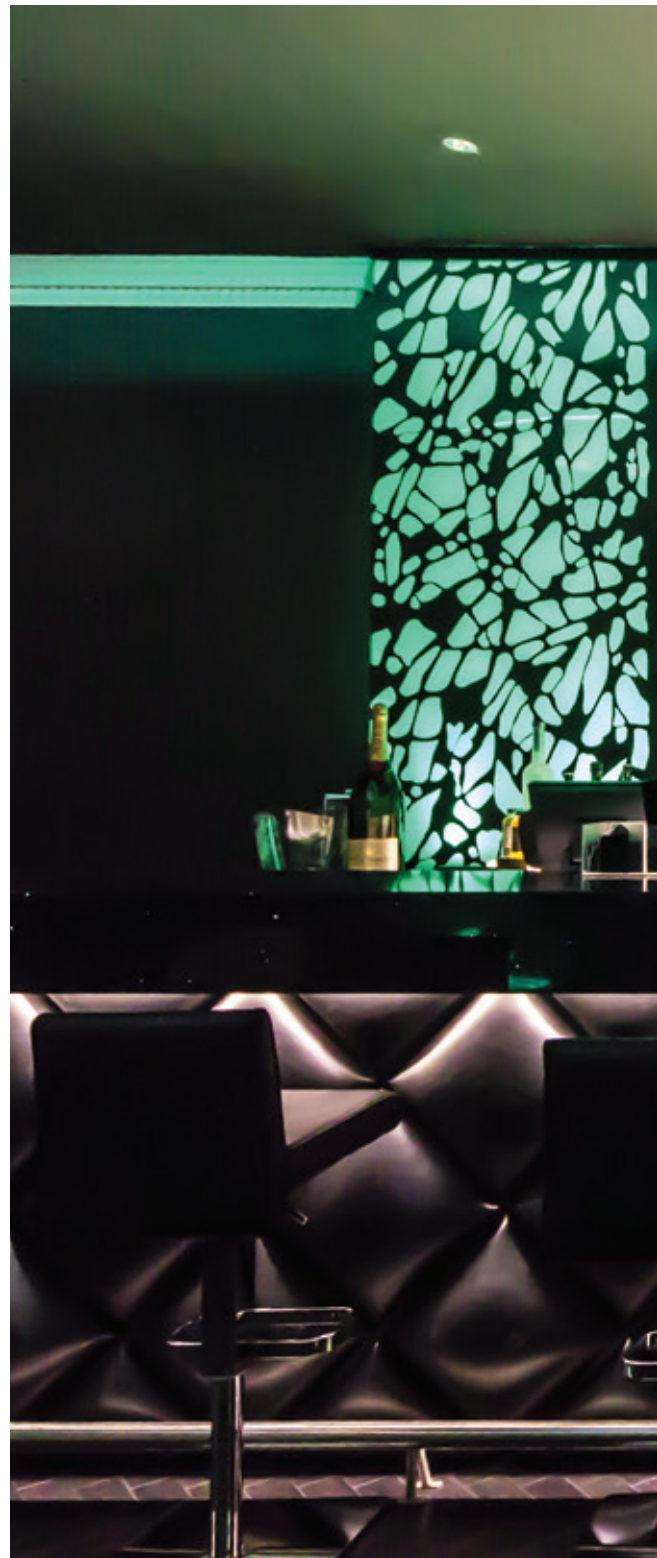

Recreate this look.

1 H5 Trimless
Page 105



2 LSR05
Page 399



3 LSC43
Page 184





2

3



Recreate this look.

1 H2 Pro 550
Page 89





Add to this look.

2 DL Pendant
Page 124



3 WL050
Page 145



Add **WL050**s at 300mm from floor level to provide a low level layer of light



Recreate this look.

1 LSV02
Page 168





Add to this look.

2 **GL016**
Page 220



Use small **GL016** fittings to highlight columns and reflect light back from the vaulted ceiling.



Recreate this look.

1 GL019
Page 213



2 WL220
Page 255







Recreate this look.

1 WL340
Page 241



2 LSV42
Page 172



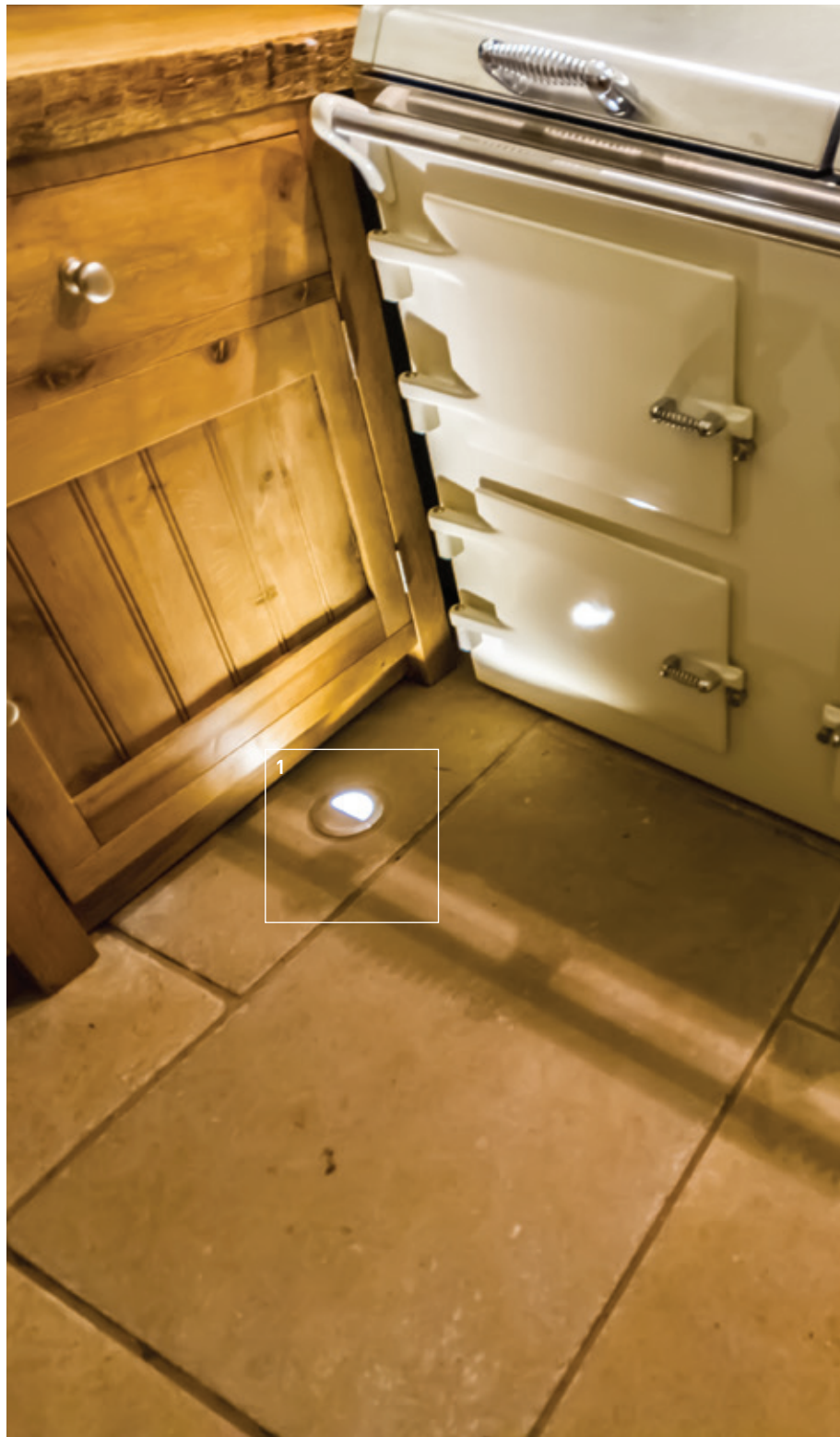



Recreate this look.

1 LSC43
Page 184



2 H2 Lite
Page 83







Recreate this look.

1 H2 Pro 550
Page 89



2 LEDSTRIP IP
Page 187





Add to this look.

3 LEDSTRIP IP
Page 187



Add another length of **LEDSTRIP IP** underneath the floating unit to provide a low level of light.



Recreate this look.

1 GL019
Page 213



2 GL050RGBW
Page 392



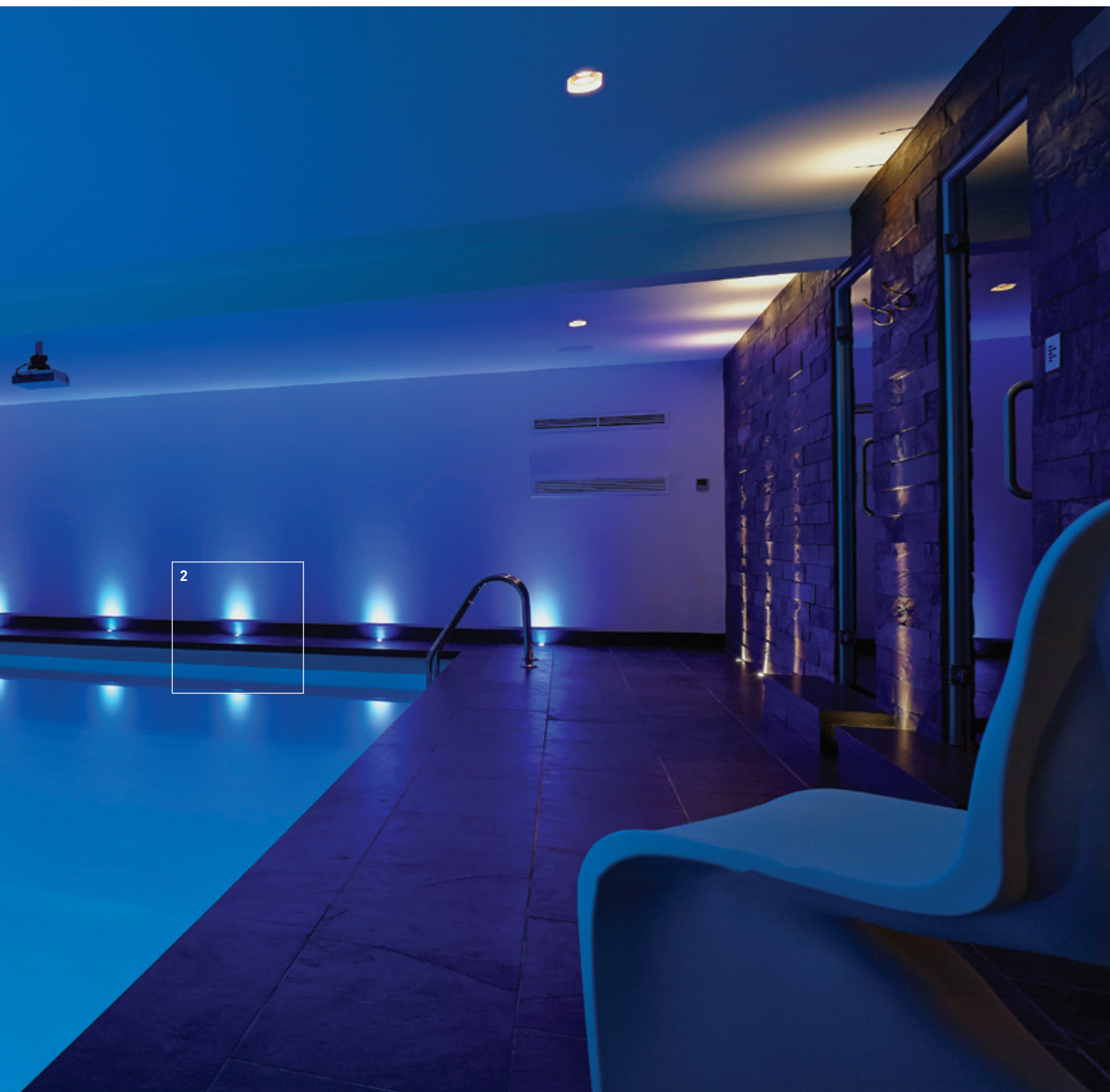

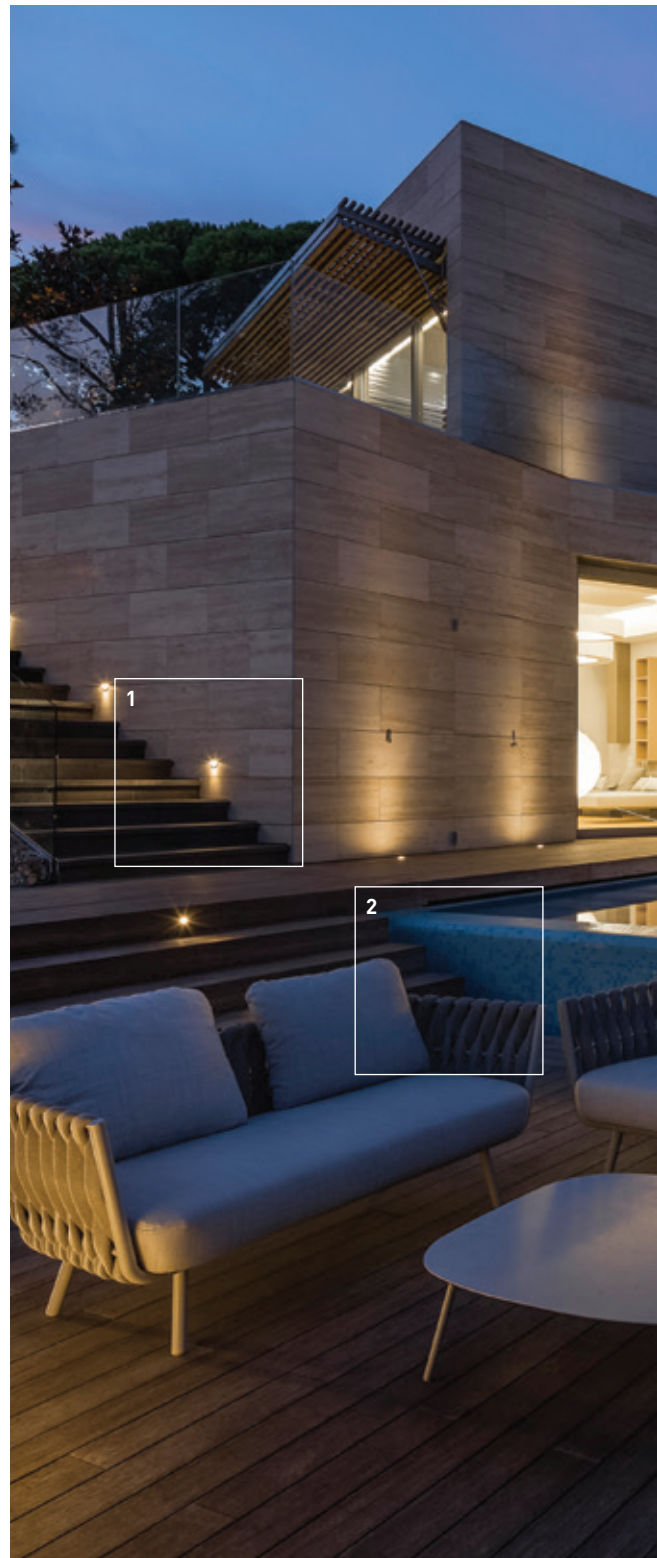

Recreate this look.

1 GL040
Page 209





Add to this look.

2 GL016

Page 220



3 BOL LED 1

Page 297



Add miniature ground lights such as **GL016** into the sides of steps and low retaining wall for a low layer of light which will frame the seating area. The wooden bollard, **BOL LED 1**, would also complement this scene and provide extra light to relax by.



Recreate this look.

1 SL030
Page 284



2 GL050
Page 230



3 LEDSTRIP IP
Page 187





Add to this look.

4 **WL075**
Page 253



WL075 could be added to the pergola as downlights to provide an additional layer of light.



Recreate this look.

1 GL07
Page 206



2 SL040
Page 283





Add to this look.

3 BOL LED MAINS
Page 296



Wooden bollards would be a good finishing touch to light this path.



Recreate this look.

1 H2 Pro Extreme
Page 97



2 LSC43
Page 184







Recreate this look.

1 RDSM
Page 328



2 LSV02
Page 168



3 LSV44
Page 174





Smart.

Smart lighting from Collingwood makes the ordinary extraordinary. Control your electronic and lighting devices using either your smartphone or with a voice command via a voice assistant to create striking lighting environments effortlessly. The smart range of products can integrate the existing lighting in the home into a smart ecosystem or use smart lamps to replace existing devices. Download the Collingwood app, named CWD Smart.

Add connected devices such as: smart bridges, lamps and plugs with a hub to take full control of your lighting. Create rooms for group control such as: bedroom, kitchen, lounge, dining room and more. The smart lighting range turns dumb lights smart, through the use of a bridge and a smart hub. A wide range of control options can create striking environments anywhere.

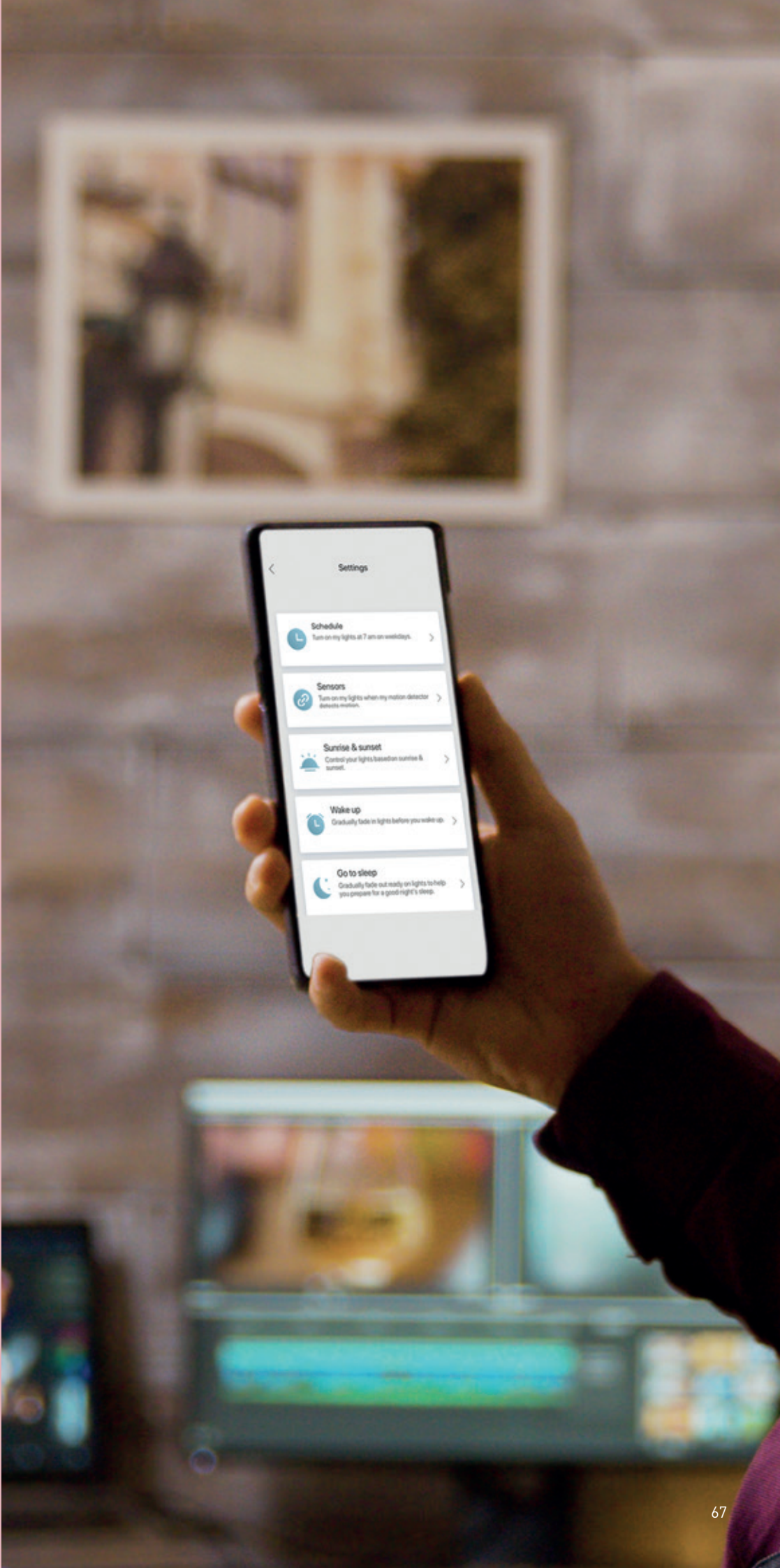

< Settings

Schedule
Turn on my lights at 7 am on weekdays. >

Sensors
Turn on my lights when my motion detector detects motion. >

Sunrise & sunset
Control your lights based on sunrise & sunset. >

Wake up
Gradually fade in lights before you wake up. >

Go to sleep
Gradually fade out my lights to help you prepare for a good night's sleep. >

Smart lighting.

Control your lights from anywhere in the world

The Collingwood Lighting range products combined with existing lighting within a home can integrate them into a smart home system, all from a touch of a button within the CWD Smart app or a voice control assistant.



Control.

Through our **CWD SMART** app, setup, control and manage your smart lighting system from anywhere in the world. Over the air (OTA) updates to the app will mean that new functionality and performance optimisations are added as soon as available.



Google is a trademark of Google LLC

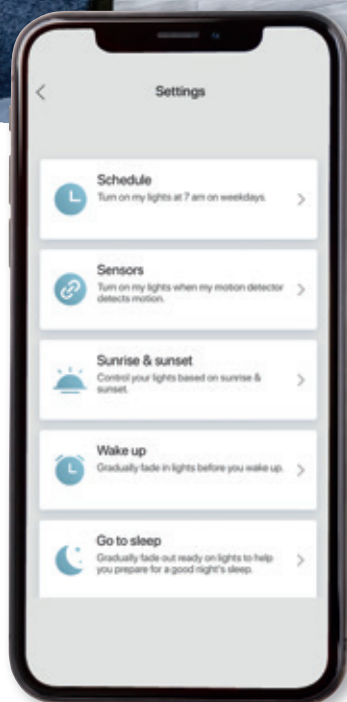

Keep your current lights.

Our Smart lighting system is an ideal choice if you want to keep your current lights and turn them into smart lights.

You can turn your current lights smart using our smart products. Install one of our smart bridges, between the light switch and the first light in the circuit, and you will be able to control your current lights through the app, voice control assistant or your switch.



Dimmable.

Dim your lights through the app or voice control assistant. You can set lighting scenes to highlight specific features in your room by dimming some lights more than others.

You can achieve this using our smart lamps or use your current dimmable lights by connecting a smart dimmable bridge.

Colour tuneable.

Using a colour tuneable lamp choose from 64,000 shades of white at the touch of a button. Use a colour slider to easily set your colour scheme through the CWD Smart app.

Option available when using colour tuneable smart lamps, see page 75.



RGBW.

Using a RGBW lamp create any colour in the spectrum at the touch of a button. Use a colour slider to easily set your colour scheme through the CWD Smart app. RGB with a colour tuneable white are built into these lamps.

Option available when using RGBW smart lamps, see page 75.



Control.

What can you control and what pre-sets can you set up

Through our CWD Smart app, setup, control and manage your smart lighting system from anywhere in the world. Over the air (OTA) updates to the app will mean that new functionality and performance optimisations are added as soon as available.

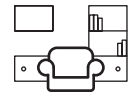
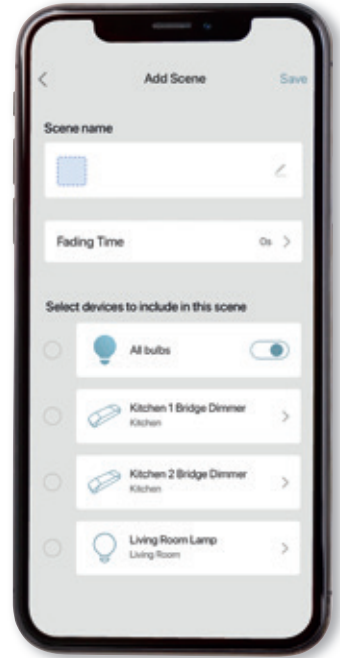
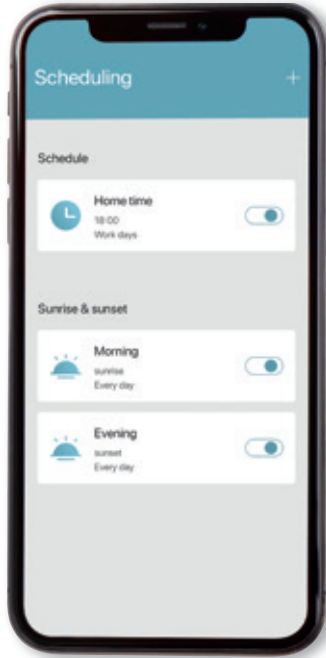

Controls.

Using your app or voice assistant as a remote for your lights you can directly control the following:

Dimming

Slide a bar on the selected lights and adjust the brightness.

Change colour

Simply roll your finger over a colour slider to select the colour that you want. This applies to both colour tuneable and RGBW lamps.

Turn on / off

Simply tap the on / off switch on the selected lights you want to turn on or off.

Group lights together

Assign lights to different rooms to control them all together.

Anywhere in the world

Control your lights or electrical devices from anywhere in the world by connecting to the internet. If you have forgotten to turn them off, turn them off using the app.

Scheduling.

Using your app, set times to turn your devices and lights on/off, adjust brightness, or activate a scene.

Arriving home from work

Set your lights to come on at a set time everyday so that you come home to a lit house.

Outdoor lights coming on in the evening

As it gets dark in the evening your garden lights could come on automatically to ensure your garden is always well lit.

Simulated occupancy

You could replicate someone still being home even though you are away to act as a deterrent against burglary.

Scene setting.

Using your app create pre-set lighting schemes that you can make happen at the touch of a button. Some examples of what you could use this feature for are the following:

Movie night

Set your lights up so the room is dark enough to highlight your TV with just enough light for it to feel warm and cosy around your sofa. Make it an intimate event.

Party

Get your accent lighting on show at full brightness and bring down the main lights to a level that is atmospheric. Now it's a party.

Atmospheric

Enjoy a romantic dinner with your partner and set the mood at the touch of a button.

Share your set up with the family.

Share your set up with other people. If you have a family of four, you can share this with everyone so that you can all control the lights. You will have one admin user.

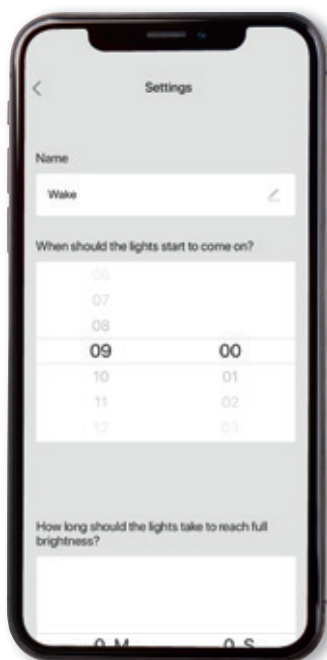

Wake up.

Use your app to simulate the sun rising or setting to make for a more natural transition to wake up to or go to sleep to.

Wake up

Set your lights to slowly get brighter like a sunrise in the morning to start your day the right way.

Bed time

Set your lights to slowly dim down helping you wind down ready for bed.

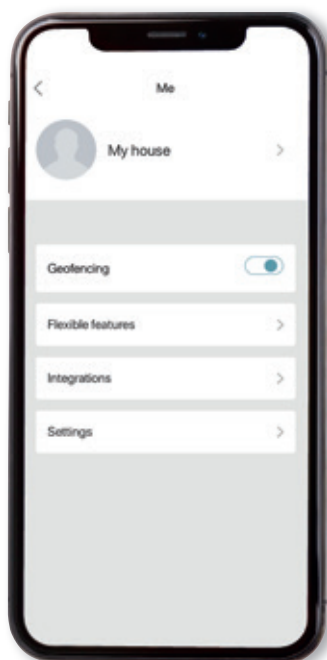

Geofencing.

The app can use your location to know that you are returning home. You can set it so that when you are a specified distance from your home the lights will turn on. Take a look at what you can control and pre-set through the Collingwood app.

Driveway

If you have a dark long driveway you could use this feature to highlight the driveway as you approach it without any need for sensors.

Home

You can get your home to light up the moment you walk into your home, which can be pretty useful when your hands are full.

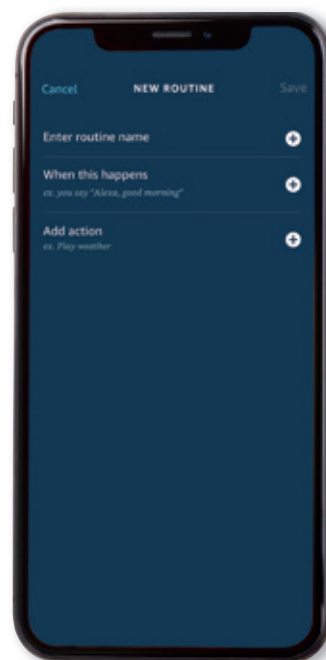

Create routines.

Using Amazon Alexa or a Google assistant you can create routines to work with other smart devices. To create a routine use you Alexa or Google assistant app and create routine by selecting 'When this happens' and then 'Add action'.

When this happens

You can choose anything to go here that is relevant to another smart device, such as 'When my smart doorbell rings'.

Add action

Now choose the lights that you want to turn on or the lighting scene you want to activate, such as 'Turn hall way lights on'.

End result

In the example we have given above the following will now happen: When someone rings my smart doorbell my hallway lights will turn on.

How does it work.

Smart for dummies

Understand what is controlled through the CWD Smart app, how it connects to the cloud and Wi-Fi, along with the mesh network to how to install each component of the smart range.

Control.

You control your smart products using the **CWD Smart** app or via a voice assistant such as Amazon Alexa or Google assistant. Your phone or voice assistant will then send the commands you have given to the cloud via the internet.



CWD Smart app

Cloud & WiFi via home router.

Once your commands are received by the cloud that information is sent to the Collingwood smart hub (or Amazon Echo Plus) via a WiFi connection.

Linking your app, smart hub and voice assistant to the cloud means that you can control your lights from anywhere in the world.

Mesh network.

The smart hub (or Amazon Echo Plus) will then communicate directly with your smart lighting products, telling them the commands you originally sent. The smart product will then tell the smart hub that the command has been completed and run back up the chain to the app.

The mesh network uses radio waves to allow all of the products to talk to each other.

If your smart product is out of range of the smart hub, then as long as it is still in range of another smart product then the command will be passed on by the other product to get to the smart product which is out of range.

Easily install products.

Our smart range has been designed to be easy to use your existing lights or easily replace your current lamps with smart lamps.

Smart dimmable bridge

Install into a ceiling void between the light switch and the first light in the circuit.

Smart non-dimmable bridge

The non-dimmable bridge is designed for use with Collingwood landscape and decorative products. It is IP20 so will need to be installed in an IP rated junction box, or in a dry location, and can be connected to Collingwood spike lights, ground lights, wall lights and more. Outside lighting can now be controlled remotely, with all the benefits of the system, such as scheduling and geo fencing.

Smart lamps

Simply replace your current lamps with our smart lamps.

Smart plug

Simply plug in the smart plug and then plug in your electrical device into the smart plug.

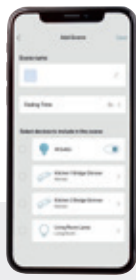

via home router



via home router



Smart hub

Smart plug



Smart lamp

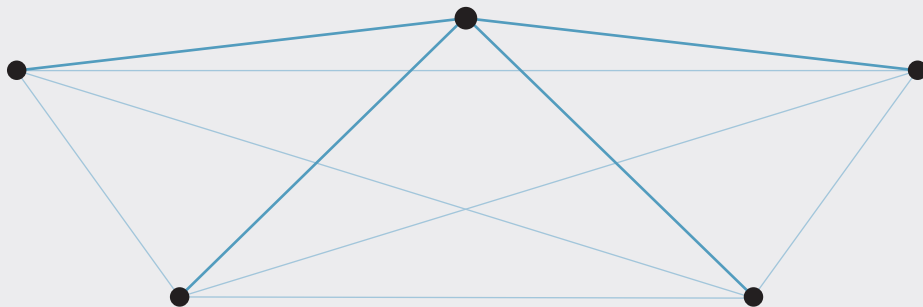

Smart dimmable bridge



Smart non-dimmable bridge



Smart products.

Choose the ideal product for your installation

We offer an option for all types of installation. Choose between using your existing lights, plug-in appliances, dimmable lamps, colour tuneable lamps and RGBW lamps to get the ideal effect for your installation.



Essential for all smart installations

To connect your smart products to the internet you will require a smart hub and CWDSMART app

(You will not require the smart hub if you have an Amazon Echo Plus)



Smart hub.

Where to install it

Simply plug it into an electrical socket. Comes with plug and cable.

Key data

Partcode	CWSHUB
Quantity of smart products per smart hub	30
Dimensions	63 x 63 x 23mm



CWD Smart app.

How to download

Download the app for free from the app store or Google play store.

Functionality

- Control
- Scheduling
- Scene setting
- Wake up
- Geofencing
- Room groupings



To make your existing dimmable lights smart choose this product

(Products will only dim if your existing lights are dimmable)



Smart dimmable bridge.

Where to install it

Into ceiling voids between the light switch and the first light in the circuit.

Key data

Partcode	CWSBRI
Maximum load	120W
Dimensions	155 x 44 x 30mm

TIP: To keep manual control, change light switch to a retractive type, found at all wholesalers or electrical outlets. This ensures the bridge is in standby when switched off, always listening for commands from the app or your voice.

Do not use with a triac wall dimmer.

To make your existing non-dimmable lights smart choose this product

(Ideal for outdoor lighting)



Smart non-dimmable bridge.

Where to install it

Into a ceiling void or waterproof junction box between the light switch and the first light in the circuit.

Key data

Partcode	CWSNBRI
Maximum load	600W
Dimensions	155 x 44 x 30mm

TIP: To keep manual control, change light switch to a retractive type, found at all wholesalers or electrical outlets. This ensures the bridge is in standby when switched off, always listening for commands from the app or your voice.



To make your plug-in electrical appliances smart choose this product

(Simply plug the electrical appliance into the smart plug)

Smart plug.

Where to install it

Into electrical socket.

Key data

Partcode	CWSPUK
Maximum load	13A
Dimensions	58.5 x 58.5 x 64.5mm



Replace your current lamps with dimmable smart lamps



GU10

Key data

Partcode	CWSGU10D
Output wattage	4.8W
Colour temp.	2700K
Lumens	350
LED lifetime	25,000hrs



B22

Key data

Partcode	CWSBCD
Output wattage	9W
Colour temp.	2700K
Lumens	806
LED lifetime	25,000hrs



E27

Key data

Partcode	CWSE27D
Output wattage	9W
Colour temp.	2700K
Lumens	806
LED lifetime	25,000hrs



Replace your current lamps with colour tuneable smart lamps



GU10

Key data

Partcode	CWSGU10C
Output wattage	4.8W
Colour temp.	2700K-6500K
Lumens	390
LED lifetime	25,000hrs



B22

Key data

Partcode	CWSBCC
Output wattage	9W
Colour temp.	2700K-6500K
Lumens	806
LED lifetime	25,000hrs



E27

Key data

Partcode	CWSE27C
Output wattage	9W
Colour temp.	2700K-6500K
Lumens	806
LED lifetime	25,000hrs



Replace your current lamps with RGBW smart lamps



GU10

Key data

Partcode	CWSGU10R
Output wattage	4.8W
Colour temp.	RGBW
Lumens	420
LED lifetime	25,000hrs



B22

Key data

Partcode	CWSBCR
Output wattage	9W
Colour temp.	RGBW
Lumens	806
LED lifetime	25,000hrs



E27

Key data

Partcode	CWSE27R
Output wattage	9W
Colour temp.	RGBW
Lumens	806
LED lifetime	25,000hrs

Residential.

Lighting has the ability to transform a home from dull and uninviting to inspiring and homely – a space to relax and be comfortable. Create that striking balance of layering light that blends seamlessly together. Consider use of dimmers as they allow for flexibility depending on the time of day, event or mood you want to create, whilst also acting as a great way to reduce energy consumption.

Here at Collingwood, we understand the need to create warm and inviting spaces, which is why we have a range of colour temperatures to choose from to create the right atmosphere for the room. Whether that's 2700K for a cosy, inviting look or 6500K to replicate natural daylight, we are confident that we have the solution for you.



Residential downlights.

Inviting and versatile environments

Creating the perfect atmosphere with lighting can transform any space from a dull and lifeless area to a warm and inviting environment.

LED colour options

Choosing the correct colour temperature for your scheme can really help to create the right environment. Available in 2700K, 3000K, 4000K and 6000K, we are committed to ensuring that we have colour consistency across our range, whether that's downlights, ground lights or LED strip lighting.

2700K



3000K



4000K



6500K



Colour switchable

Creating the ambience and mood of a room is hugely dependent on the lighting chosen. That is why we provide two colour switchable options which can alternate between three colour temperatures without any additional wiring required. Our products can be switched under the bezel but also using a standard wall switch or dimmer.

3000K



4000K



6500K



Dim to warm

For a warmer and more comfortable environment, our products can replicate the atmosphere typically created by a dimmed incandescent lamp with all the benefits of a Collingwood LED.

3000K (100% intensity)



2400K (50% intensity)



1800K (25% intensity)

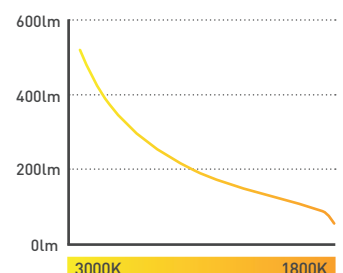

Bezel options

Our bezels have a slimline, flush finish with a twist and lock technology that ensures replacing these is a quick and easy process. Choose from a wide selection of round and square bezels in a range of colour options.

H2 range: round

H2 range: square

H4 range: round



Insulation coverable

Many of our downlights are insulation coverable, suitable for both rolled and blown installation.

Rolled insulation

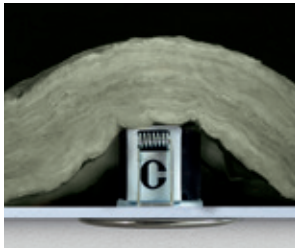

Blown insulation



Low glare

Low glare lighting is ideal for creating spaces designed for comfort, relaxation and enjoyment and where light is not needed to be the focus. View our 1901 and Elect ranges which have been specifically designed for low glare.

Low glare



Glare



Single point source Vs Tri-LED

We offer both types of lens within our downlights range.

Single point source

Choose a single point source lens for a symmetrical design that replicated the look and feel of a traditional halogen lamp.



Tri-LED

The Tri-LED aesthetic has become synonymous with LED technology. Choose this lens for the perfect finish to any modern space.



Concealed lighting

Our trimless products are designed to completely conceal the fitting. The plate is placed flush to the ceiling and plastered over, concealing the plate and offering crisp ceiling lines.



Residential downlights.

Inviting and versatile environments

Creating the perfect atmosphere with lighting can transform any space from a dull and lifeless area to a warm and inviting environment.

Easy-fit connector

The Easy-fit connector is designed to minimise installation time and ensure fitting the product is as easy as possible. It has a push-fit connector to make wiring to the mains a less time-consuming process and the light can be attached or replaced by anyone quickly and efficiently.

- Piano key connector for ease of installation
- First-fix compatible
- Retro-fit compatible
- Less risk of damaging fittings and ceiling during installation
- No tools required for installation (when already attached to product)
- Loop-in loop-out
- 16A rated

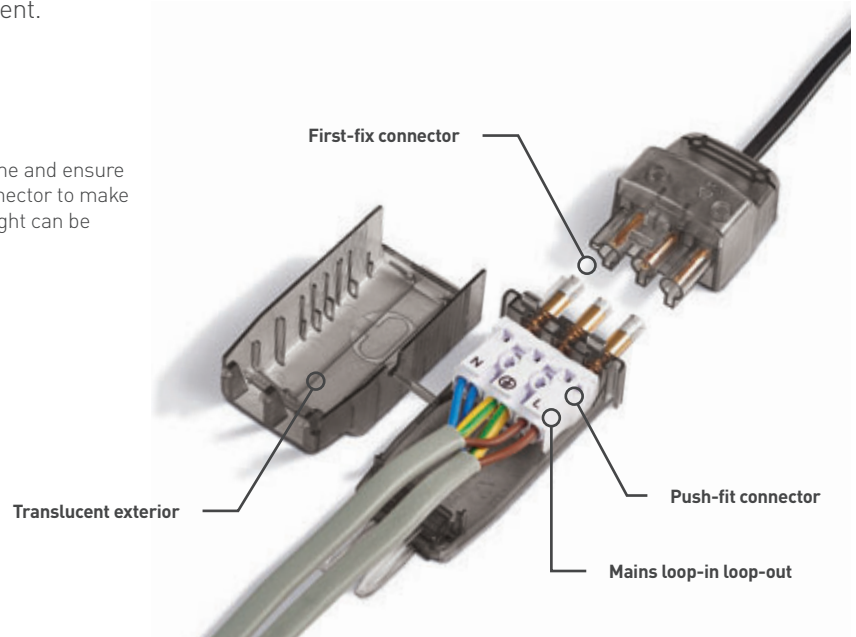

IP ratings

Our downlights range offer an IP rated product for every installation.

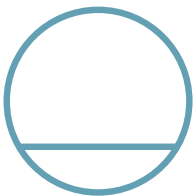

Ideal for use indoors and where there is no risk of water splashing the product.



Ideal for use indoors, in bathrooms and other places where water might splash the product.



Ideal for use indoors or outdoors, in bathrooms and other places where water may be sprayed onto the product.

High efficacy

We strive to ensure all of our products are as energy efficient as possible.

Many of our downlights have been upgraded to efficacy ratings of over 100lm/W. Not only do they feature innovation, performance and premium quality, they are also light on energy consumption and bills.

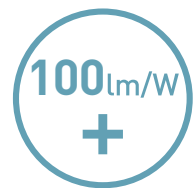

Beam angles

Products with a wide beam angle cover a wider area with fewer lights, reducing time and cost spent on fittings. Alternatively, products with a narrow beam angle have a great light intensity and are perfect for smaller spaces.

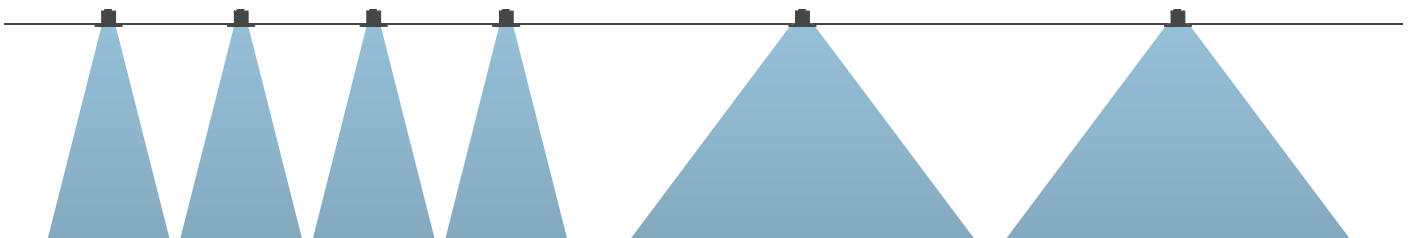

H2 Pro Extreme

The H2 Pro Extreme is an innovation first for Collingwood, with the unique feature of a completely waterproof seal. This downlight is IP65 rated from both the front and back, which means it can be used with complete confidence in a range of outdoor applications including soffits and eaves, external garage facades and commercial buildings.

IP65 front & back

The H2 Pro Extreme is IP65 from the front and the back making it perfect for soffits and other outdoor installations. Where most IP65 downlights would fail due to moisture getting in through the back of the product the H2 Pro Extreme thrives, being completely protected at an IP65 rating.

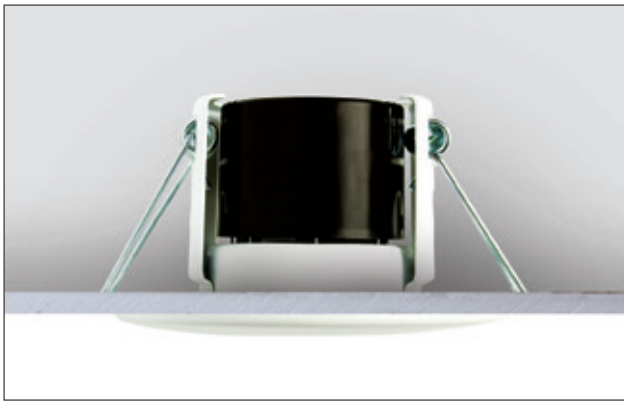

Corrosion resistant protection

Rust resistant technology maintains the products fit, form and function for its entire lifespan.



Salt mist protective paint

Specialist paint ensures protection in coastal areas.



Emergency pack service

In the event of a power outage, your emergency lighting system will illuminate a safe evacuation route from commercial and high occupancy buildings such as office spaces, hospitals and hotels.

Collingwood Lighting's pre-wired emergency pack service option is available across a large selection of our downlight range offering a flexible solution to compliment any lighting scheme. With this service, the wiring has already been completed so you don't have to, providing peace of mind and reducing installation time.

Adjustable fittings



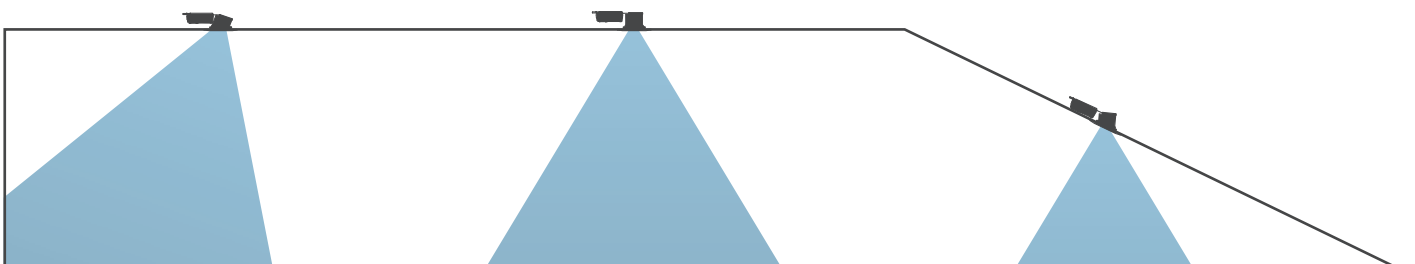















Collingwood's adjustable range provides a versatility that is perfect for vaulted ceilings, standard ceilings and for highlighting features and artwork on walls.



Cut out size guide.

For your downlights

Use the guide below to determine the recommended cut-out size for each Collingwood downlight. For retro-fitting varied sizes, view our converter plate range on **page 106**.

60 - 72mm	64 - 72mm	65- 75mm	69 - 72mm
 H2 Pro Elect Trimless	 H2 Lite	 H2 Pro Extreme	 H4 Lite
 H5 Trimless	 H2 Lite 500		 H4 Pro 550
	 H2 Lite 500 CSW		 H4 Pro 550 SPS
	 H2 Lite 500 CSP		 H4 Pro Elect
	 H2 Lite 400 CSP		 H4 Pro 700
	 H2 Pro 550		
	 H2 Pro 550 SPS		
	 H2 Pro 550 CS		
	 H2 Pro Dusk		
	 H2 Pro Elect		
	 H2 Pro 700		

Residential downlights.

01604 495 151
collingwoodlighting.com

 @collingwoodLED

 /collingwoodlighting

 collingwoodled

GUARANTEE / WARRANTY

4 year extended warranty

FEATURES & BENEFITS

100lm/W+

Insulation coverable

Only 4.4W

Uses single point source technology to replicate traditional halogen look

Mains dimmable

Compact integral driver for easy installation

Push-fit terminal connector included

LED downlight complete with integrated bezel for a straightforward fit



H2 Lite

Dimmable, fire-rated downlight with integrated bezel & Easy-fit connector

FEATURES

Wattage	4.4W
IP rating	IP65
Colour flexibility	Fixed colour
Tilttable	No
UGR	22
Dimmable	Yes
Input	Mains AC
LED lifetime	40,000h L70 B10
SDCM	3SDCM
Flicker free	Yes
Emergency version available	No

INSTALLATION INFORMATION

Install connector type	Easy-fit connector
Insulation coverable	Rolled insulation
Cut out size	Ø 64-72mm
Bathroom zone	1
Inrush current	1A 0.25ms
Construction material	Mild steel / VO rated plastic insulation protector built in
Maximum ceiling thickness	40mm
Weight	160g
Maximum ambient temperature	40°C
SELV	Yes
Building regulations	Part B, C, E, P, L
Electric class (1, 2, 3)	2

PHOTOMETRICS @ 25°C

Product code	Finish	Colour	Beam angle	CRI	lm	lm/W	lx at 1m
DLT388BS5540	Brushed steel	4000K	55°	>80Ra	460	105	527
DLT388BS5530	Brushed steel	3000K	55°	>80Ra	440	100	504
DLT388CR5540	Chrome	4000K	55°	>80Ra	460	105	527
DLT388CR5530	Chrome	3000K	55°	>80Ra	440	100	504
DLT388MW5540	Matt white	4000K	55°	>80Ra	460	105	527
DLT388MW5530	Matt white	3000K	55°	>80Ra	440	100	504

WIRING INFORMATION

Cable / flying lead	0.15m
Cable required for connector	Push-fit terminal for: Twin & Earth (6242Y 2x1.5mm ²) or 3-core cable (R02V 3x1.5mm ²)
Type of wiring required	Parallel

LED DRIVERS

Product code	Input	SELV	Dimming	Bathroom zone	Min	Max
N/A (integrated SELV driver)	220-240V	SELV	Yes (mains)	1 (ceiling only)	N/A	N/A

ACCESSORIES

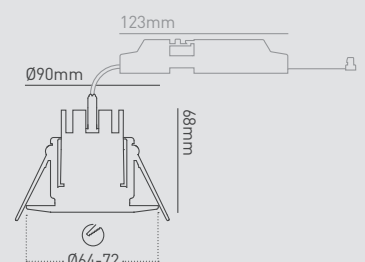
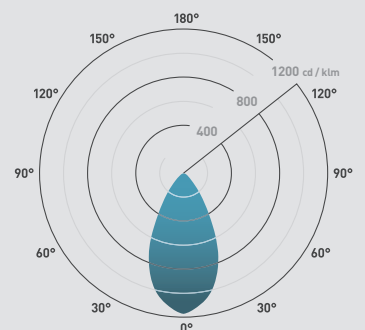

DLCONVERT70	Converter plate	Sold separately	106
DM298GRID	LED mains grid dimmer	Sold separately	107
DM298FP	Faceplate dimmer	Sold separately	107
DLCVT110	Converter plate	Sold separately	106

Beam angle: 55°



Residential downlights.

01604 495 151
collingwoodlighting.com

-  @collingwoodLED
-  /collingwoodlighting
-  collingwoodled

GUARANTEE / WARRANTY

4 year extended warranty

FEATURES & BENEFITS

- 100lm/W
- Only 5W
- Mains dimmable
- LED downlight complete with bezel for a straightforward fit
- Flexible driver position for easy installation
- Easy-fit connector included
- Shallow depth of 49mm
- Uses single point source technology to replicate traditional halogen look
- Compatible with rolled insulation

Beam angle: 60°

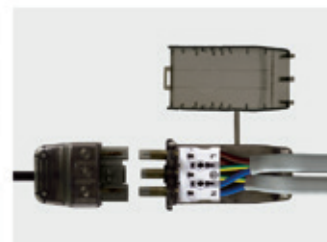
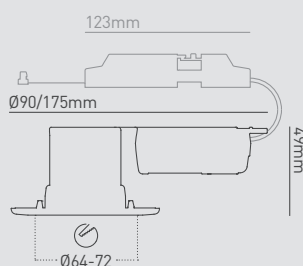
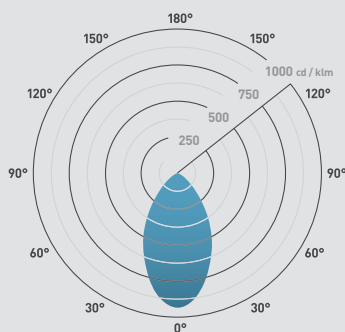

H2 Lite 500

Single point source, dimmable LED downlight with bezel & Easy-fit connector

FEATURES

Wattage	5W
IP rating	IP65
Colour flexibility	Fixed colour
Tilttable	No
UGR	25
Dimmable	Yes
Input	Mains AC
LED lifetime	40,000h L70 B10
SDCM	3SDCM
Flicker free	Yes
Emergency version available	No

INSTALLATION INFORMATION

Install connector type	Easy-fit connector
Insulation coverable	Rolled insulation
Cut out size	Ø 64-72mm
Bathroom zone	1
Inrush current	1.2A 0.03ms
Construction material	Mild steel / VO rated plastic insulation protector built in
Maximum ceiling thickness	40mm
Weight	230g
Maximum ambient temperature	40°C
SELV	Yes
Building regulations	Part B, C, E, P, L
Electric class [1, 2, 3]	2

PHOTOMETRICS @ 25°C

Product code	Finish	Colour	Beam angle	CRI	lm	lm/W	lx at 1m
DLT469BS6040	Brushed steel	4000K	60°	>80Ra	500	100	460
DLT469BS6030	Brushed steel	3000K	60°	>80Ra	500	100	460
DLT469MW6040	Matt white	4000K	60°	>80Ra	500	100	460
DLT469MW6030	Matt white	3000K	60°	>80Ra	500	100	460

WIRING INFORMATION

Cable / flying lead	0.15m
Cable required for connector	Push-fit terminal for: Twin & Earth (6242Y 2x1.5mm ²) or 3-core cable (R02V 3x1.5mm ²)
Type of wiring required	Parallel

LED DRIVERS

Product code	Input	SELV	Dimming	Bathroom zone	Min	Max
N/A (integrated SELV driver)	220-240V	SELV	Yes (mains)	1 (ceiling only)	N/A	N/A

ACCESSORIES

DLCONVERT70	Converter plate	Sold separately	106
DM298GRID	LED mains grid dimmer	Sold separately	107
DM298FP	Faceplate dimmer	Sold separately	107
DLCVT110	Converter plate	Sold separately	106

Residential downlights.

01604 495 151
collingwoodlighting.com

 @collingwoodLED

 /collingwoodlighting

 collingwoodled

GUARANTEE / WARRANTY

4 year extended warranty

FEATURES & BENEFITS

- 3 colour temperatures in one product
- Easily choose CCT with standard wall switch or dimmer
- High efficacy of up to 80lm/W
- Only 6.4W
- Mains dimmable
- Push-fit terminal connector included
- LED downlight complete with bezel for a straightforward fit
- Flexible driver position for easy installation
- Shallow depth of 49mm
- Compatible with rolled insulation



H2 Lite 500 CSW

Wall controlled, colour switchable downlight with bezel & connector

FEATURES

Wattage	6.4W
IP rating	IP65
Colour flexibility	Colour switchable
Tilttable	No
UGR	25
Dimmable	Yes
Input	Mains AC
LED lifetime	40,000h L70, B10
SDCM	3SDCM
Flicker free	Yes
Emergency version available	No

INSTALLATION INFORMATION

Install connector type	Push-fit terminal connector
Insulation coverable	Rolled insulation
Cut out size	Ø 64-72mm
Bathroom zone	1
Inrush current	1.1A 0.02ms
Construction material	Mild steel / VO rated plastic insulation protector built in
Maximum ceiling thickness	40mm
Weight	230g
Maximum ambient temperature	40°C
SELV	Yes
Building regulations	Part B, C, E, P, L
Electric class [1, 2, 3]	2

PHOTOMETRICS @ 25°C

Product code	Finish	Colour	Beam angle	CRI	lm	lm/W	Lx at 1m
DLT470BS6500	Brushed steel	6500K	65°	>80Ra	510	80	414
DLT470BS6500	Brushed steel	4000K	65°	>80Ra	510	80	414
DLT470BS6500	Brushed steel	3000K	65°	>80Ra	490	77	397
DLT470MW6500	Matt white	6500K	65°	>80Ra	510	80	414
DLT470MW6500	Matt white	4000K	65°	>80Ra	510	80	414
DLT470MW6500	Matt white	3000K	65°	>80Ra	490	77	397

WIRING INFORMATION

Cable / flying lead	0.15m
Cable required for connector	Push-fit terminal for: Twin & Earth (6242Y 2x1.5mm ²) or 3-core cable (R02V 3x1.5mm ²)
Type of wiring required	Parallel

LED DRIVERS

Product code	Input	SELV	Dimming	Bathroom zone	Min	Max
N/A (integrated SELV driver)	220-240V	SELV	Yes (mains)	1 (ceiling only)	N/A	N/A

ACCESSORIES

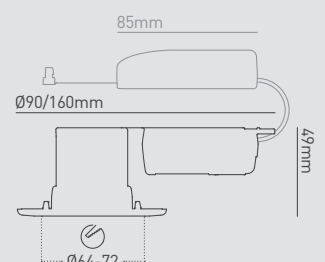
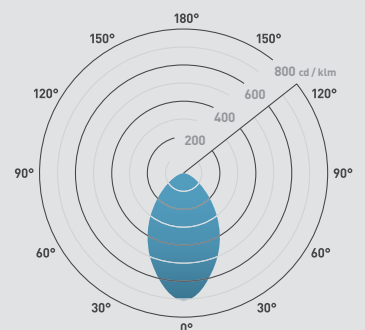

DLCONVERT70	Converter plate	Sold separately	106
DM298GRID	LED mains grid dimmer	Sold separately	107
DM298FP	Faceplate dimmer	Sold separately	107
DLCVT110	Converter plate	Sold separately	106

Beam angle: 65°



Residential downlights.

01604 495 151
collingwoodlighting.com

 @collingwoodLED
 /collingwoodlighting
 collingwoodled

GUARANTEE / WARRANTY

4 year extended warranty

FEATURES & BENEFITS

- 3 colour temperatures in one product
- Easily choose CCT via a switch under the product bezel
- High efficacy of up to 97lm/W
- Only 6.4W
- Mains dimmable
- Integrated loop-in, loop-out, push-fit terminal connector included
- Flexible driver position for easy installation
- Compatible with rolled insulation

Beam angle: 60°

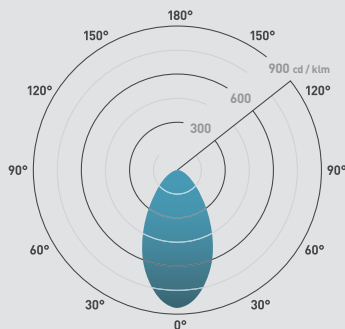

Ø90/168mm

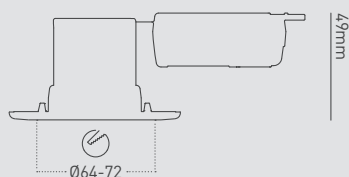

H2 Lite 500 CSP

Colour switchable, dimmable, fire-rated downlight, integrated push-fit connector

FEATURES

Wattage	6.4W
IP rating	IP65
Colour flexibility	Colour switchable
Tilttable	No
UGR	22
Dimmable	Yes
Input	Mains AC
LED lifetime	40,000h L70 B10
SDCM	3SDCM
Flicker free	Yes
Emergency version available	No

INSTALLATION INFORMATION

Install connector type	Integrated push-fit terminal connector
Insulation coverable	All insulation
Cut out size	Ø 64-72mm
Bathroom zone	1
Inrush current	2.2A 0.025mS
Construction material	Mild steel / aluminium
Maximum ceiling thickness	40mm
Weight	208g
Maximum ambient temperature	40°C
SELV	Yes
Building regulations	Part B, C, E, P, L
Electric class (1, 2, 3)	2

PHOTOMETRICS @ 25°C

Product code	Colour	Beam angle	CRI	lm	lm/W	lx at 1m
DLT4566000	6500K	60°	>80Ra	570	89	483
	4000K	60°	>80Ra	620	97	525
	3000K	60°	>80Ra	540	84	458

WIRING INFORMATION

Cable / flying lead	No
Cable required for connector	Push-fit terminal for: Twin & Earth (6242Y 2x1.5mm ²) or 3-core cable (R02V 3x1.5mm ²)
Type of wiring required	Parallel

LED DRIVERS

Product code	Input	SELV	Dimming	Bathroom zone	Min	Max
N/A (integrated SELV driver)	220-240V	SELV	Yes (mains)	1 (ceiling only)	N/A	N/A

ACCESSORIES

H2 range bezels	Round & square H2 bezel options	Sold separately	98
DLCONVERT70	Converter plate	Sold separately	106
DM298GRID	LED mains grid dimmer	Sold separately	107
DM298FP	Faceplate dimmer	Sold separately	107
DLCVT110	Converter plate	Sold separately	106



Residential downlights.

01604 495 151
collingwoodlighting.com

@collingwoodLED

/collingwoodlighting

collingwoodled

H2 Lite 400 CSP

Colour switchable, dimmable, fire-rated downlight, integrated push-fit connector

FEATURES

Wattage	4.5W
IP rating	IP65
Colour flexibility	Colour switchable
Tilttable	No
UGR	22
Dimmable	Yes
Input	Mains AC
LED lifetime	40,000h L70 B10
SDCM	4SDCM
Flicker free	Yes
Emergency version available	No

INSTALLATION INFORMATION

Install connector type	Integrated push-fit terminal connector included
Insulation coverable	Blown and rolled
Cut out size	Ø 64-72mm
Bathroom zone	1
Inrush current	1.5A 0.025ms
Construction material	Mild steel / aluminium
Maximum ceiling thickness	40mm
Weight	300g
Maximum ambient temperature	40°C
SELV	Yes
Building regulations	Part B, C, E, P & L
Electric class (1, 2, 3)	2

GUARANTEE / WARRANTY

4 year extended warranty

FEATURES & BENEFITS

- 3 colour temperatures in one product
- Easily choose CCT via a switch under the product bezel
- High efficacy of up to 102lm/W
- 4.5W
- Mains dimmable
- Integrated loop-in, loop-out, push-fit terminal connector included
- Flexible driver position for easy installation

PHOTOMETRICS @ 25°C

Product code	Colour	Beam angle	CRI	lm	lm/W	Lx at 1m
DLT4564000	6500K	60°	>80Ra	450	100	330
	4000K	60°	>80Ra	460	102	337
	3000K	60°	>80Ra	410	91	300

WIRING INFORMATION

Cable / flying lead	0.15m (Class II)
Cable required for connector	Push-fit terminal for: Twin & Earth (6242Y 2x1.5mm ²) or 3-core cable (R02V 3x1.5mm ²)
Type of wiring required	Parallel

LED DRIVERS

Product code	Input	SELV	Dimming	Bathroom zone	Min	Max
N/A (integrated SELV driver)	220-240V	-	-	-	-	-

ACCESSORIES

H2 range bezels	Round & square H2 bezel options	Sold separately	98
DLCNVERT70	Converter plate	Sold separately	106
DM298GRID	LED mains grid dimmer	Sold separately	107
DM298FP	Faceplate dimmer	Sold separately	107
DLCVT110	Converter plate	Sold separately	106

Beam angle: 60°

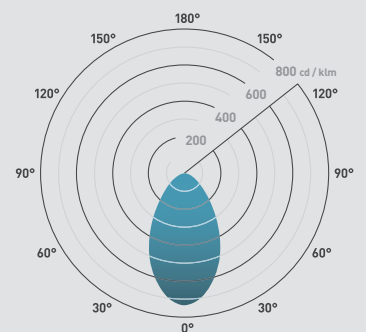

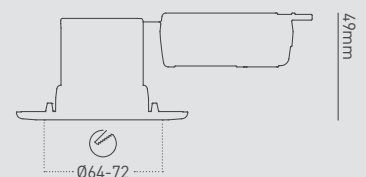

Ø90/168mm



Residential downlights.

01604 495 151
collingwoodlighting.com

 @collingwoodLED
 /collingwoodlighting
 collingwoodled

GUARANTEE / WARRANTY

4 year extended warranty

FEATURES & BENEFITS

±20° adjustable downlight to adjust direction of light

Easy-fit connector

105lm/W

Low energy consumption

IP65 rating

55° beam angle

Mains dimmable as standard

Insulation coverable



H4 Lite

Adjustable LED downlight with integrated bezel and Easy-fit connector

FEATURES

Wattage	4.4W
IP rating	IP65
Colour flexibility	Fixed colour
Tilttable	20°
UGR	22
Dimmable	Yes
Input	Mains AC
LED lifetime	40,000h L70 B10
SDCM	3SDCM
Flicker free	Yes
Emergency version available	No

INSTALLATION INFORMATION

Install connector type	Easy-fit connector
Insulation coverable	Rolled insulation
Cut out size	Ø 69-72mm
Bathroom zone	1
Inrush current	1A 0.25ms
Construction material	Mild steel / VO rated plastic insulation protector built in
Maximum ceiling thickness	40mm
Weight	240g
Maximum ambient temperature	40°C
SELV	Yes
Building regulations	Part B, C, E, P, L
Electric class (1, 2, 3)	2

PHOTOMETRICS @ 25°C

Product code	Finish	Colour	Beam angle	CRI	lm	lm/W	lx at 1m
DL490BS5540	Brushed steel	4000K	55°	>80Ra	460	105	527
DL490BS5530	Brushed steel	3000K	55°	>80Ra	440	100	504
DL490CR5540	Chrome	4000K	55°	>80Ra	460	105	527
DL490CR5530	Chrome	3000K	55°	>80Ra	440	100	504
DL490MW5540	Matt white	4000K	55°	>80Ra	460	105	527
DL490MW5530	Matt white	3000K	55°	>80Ra	440	100	504

WIRING INFORMATION

Cable / flying lead	0.15m
Cable required for connector	Push-fit terminal for: Twin & Earth (6242Y 2x1.5mm ²) or 3-core cable (R02V 3x1.5mm ²)
Type of wiring required	Parallel

LED DRIVERS

Product code	Input	SELV	Dimming	Bathroom zone	Min	Max
N/A (integrated SELV driver)	220-240V	SELV	Yes (mains)	1 (ceiling only)	N/A	N/A

ACCESSORIES

H2 range bezels	Round & square H2 bezel options	Sold separately	98
DLCONVERT70	Converter Plate Range	Sold separately	106
DM298GRID	Grid Dimmer	Sold separately	107
DM298FP	Flatplate Dimmer	Sold separately	107
DLCVT110	Converter plate	Sold separately	106

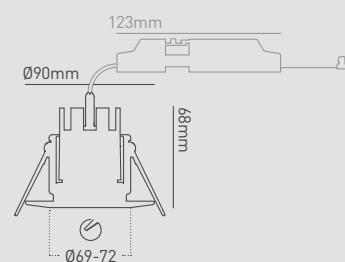
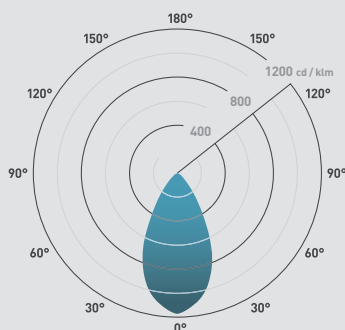

Beam angle: 55°





Residential downlights.

01604 495 151
collingwoodlighting.com

-  @collingwoodLED
-  /collingwoodlighting
-  collingwoodled

GUARANTEE / WARRANTY

7 year extended warranty

H2 Pro 550

Dimmable, fire-rated downlight

FEATURES

Wattage	5.2W
IP rating	IP65
Colour flexibility	Fixed colour
Tilttable	No
UGR	16
Dimmable	Yes
Input	Mains AC
LED lifetime	70,000h L70 B10
SDCM	3SDCM
Flicker free	Yes
Emergency version available	Yes

INSTALLATION INFORMATION

Install connector type	Easy-fit connector
Insulation coverable	All insulation
Cut out size	Ø 64-72mm
Bathroom zone	1
Inrush current	1.4A /0.1ms
Construction material	Mild steel / VO rated plastic insulation protector built in
Maximum ceiling thickness	40mm
Weight	186g
Maximum ambient temperature	40°C
SELV	Yes
Building regulations	Part B, C, E, P, L
Electric class (1, 2, 3)	2

FEATURES & BENEFITS

- 100lm/W+
- Only 5.2W
- Mains dimmable
- Slimline twist & lock bezels (sold separately)
- Flexible driver position for easy installation
- Shallow depth of 49mm
- Insulation coverable
- The original Collingwood Lighting downlight

PHOTOMETRICS @ 25°C

Product code	Emergency	Colour	Beam angle	CRI	lm	lm/W	lx at 1m
DLE4727040	Non-emergency	4000K	70°	>80Ra	580	112	496
DLE4723840	Non-emergency	4000K	38°	>80Ra	580	112	1237
DLE4727030	Non-emergency	3000K	70°	>80Ra	550	106	462
DLE4723830	Non-emergency	3000K	38°	>80Ra	550	106	1173
DLE4727040EM	Emergency	4000K	70°	>80Ra	580	112	496
DLE4723840EM	Emergency	4000K	38°	>80Ra	580	112	1237
DLE4727030EM	Emergency	3000K	70°	>80Ra	550	106	462
DLE4723830EM	Emergency	3000K	38°	>80Ra	550	106	1173

WIRING INFORMATION

Cable / flying lead	0.15m
Cable required for connector	Push-fit terminal for: Twin & Earth (6242Y 2x1.5mm ²) or 3-core cable (R02V 3x1.5mm ²)
Type of wiring required	Parallel

LED DRIVERS

Product code	Input	SELV	Dimming	Bathroom zone	Min	Max
N/A (integrated SELV driver)	220-240V	SELV	Yes (mains)	1 (ceiling only)	N/A	N/A

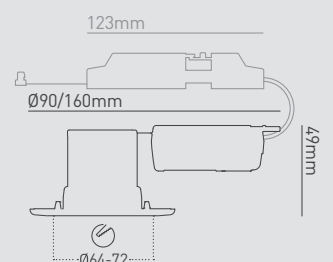
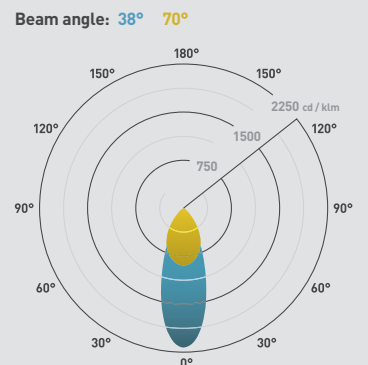

ACCESSORIES

H2 range bezels	Round and square bezel options	Sold separately	98
DLCONVERT70 & DLCVT110	Converter plates	Sold separately	106
DM298GRID & DM298FP	Grid Dimmer & Flatplate Dimmer	Sold separately	107



Residential downlights.

01604 495 151
collingwoodlighting.com

 @collingwoodLED
 /collingwoodlighting
 collingwoodled

GUARANTEE / WARRANTY

7 year extended warranty available

FEATURES & BENEFITS

100lm/W+
Only 5.2W
DALI dimmable
Slimline twist & lock bezels (sold separately)
Shallow depth of 49mm
Insulation coverable

Beam angle: 38° 70°

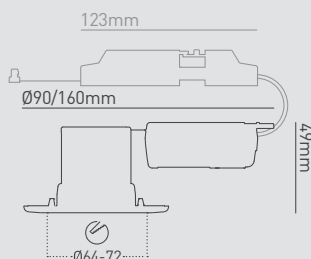
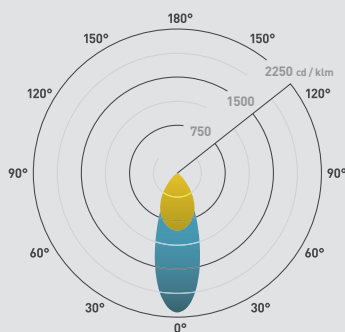

H2 Pro 550 DALI

Dimmable, fire-rated downlight

FEATURES

Wattage	5.2W
IP rating	IP65
Colour flexibility	Fixed colour
Tilttable	No
UGR	16
Dimmable	Yes
Input	Mains AC
LED lifetime	70,000h L70 B10
SDCM	3SDCM
Flicker free	Yes
Emergency version available	Yes

INSTALLATION INFORMATION

Install connector type	Easy-fit connector
Insulation coverable	All insulation
Cut out size	Ø 64-72mm
Bathroom zone	1
Inrush current	1.4A / 0.1ms
Construction material	Mild steel / VO rated plastic insulation protector built in
Maximum ceiling thickness	40mm
Weight	186g
Maximum ambient temperature	40°C
SELV	Yes
Building regulations	Part B, C, E, P, L
Electric class [1, 2, 3]	2

PHOTOMETRICS @ 25°C

Product code	Emergency	Colour	Beam angle	CRI	lm	lm/W	lx at 1m
DLE4727040D	Non-emergency	4000K	70°	>80Ra	580	112	496
DLE4723840D	Non-emergency	4000K	38°	>80Ra	580	112	1237
DLE4727030D	Non-emergency	3000K	70°	>80Ra	550	106	462
DLE4723830D	Non-emergency	3000K	38°	>80Ra	550	106	1173
DLE4727040DEM	Emergency	4000K	70°	>80Ra	580	112	496
DLE4723840DEM	Emergency	4000K	38°	>80Ra	580	112	1237
DLE4727030DEM	Emergency	3000K	70°	>80Ra	550	106	462
DLE4723830DEM	Emergency	3000K	38°	>80Ra	550	106	1173

WIRING INFORMATION

Cable / flying lead	0.15m
Cable required for connector	Push-fit terminal for: Twin & Earth (6242Y 2x1.5mm ²) or 3-core cable (R02V 3x1.5mm ²)
Type of wiring required	Parallel

LED DRIVERS



Product code	Input	SELV	Dimming	Bathroom zone	Min	Max
N/A (integrated SELV driver)	220-240V	SELV	Yes (DALI)	1 (ceiling only)	N/A	N/A

ACCESSORIES

H2 range bezels	Round and square bezel options	Sold separately	98
DLCONVERT70	Converter plate	Sold separately	106
DLCVT110	Converter plate	Sold separately	106

Residential downlights.

01604 495 151
collingwoodlighting.com

 @collingwoodLED
 /collingwoodlighting
 collingwoodled

GUARANTEE / WARRANTY

7 year extended warranty

FEATURES & BENEFITS

110lm/W+
 Only 5W
 Mains dimmable
 Slimline twist & lock bezels (sold separately)
 Flexible driver position for easy installation
 Shallow depth of 49mm
 Uses single point source technology to replicate traditional halogen look
 Compatible with all types of insulation



H2 Pro 550 SPS

Single point source, dimmable, fire-rated downlight

FEATURES

Wattage	5W
IP rating	IP65
Colour flexibility	Fixed colour
Tilttable	No
UGR	-
Dimmable	Yes
Input	Mains AC
LED lifetime	70,000h L70, B10
SDCM	3SDCM
Flicker free	Yes
Emergency version available	Yes

INSTALLATION INFORMATION

Install connector type	Push-fit terminal connector
Insulation coverable	All insulation
Cut out size	Ø 64-72mm
Bathroom zone	1
Inrush current	1.2A 0.03ms
Construction material	Mild steel / VO rated plastic insulation protector built in
Maximum ceiling thickness	40mm
Weight	230g
Maximum ambient temperature	40°C
SELV	Yes
Building regulations	Part B, C, E, P, L
Electric class [1, 2, 3]	2

PHOTOMETRICS @ 25°C

Product code	Emergency	Colour	Beam angle	CRI	lm	lm/W	Lx at 1m
DLT4335540	Non-emergency	4000K	55°	>80Ra	560	112	516
DLT4335530	Non-emergency	3000K	55°	>80Ra	550	110	506
DLT4335540EM	Emergency	4000K	55°	>80Ra	390	156	359
DLT4335530EM	Emergency	3000K	55°	>80Ra	370	148	341

WIRING INFORMATION

Cable / flying lead	0.15m
Cable required for connector	Push-fit terminal for: Twin & Earth (6242Y 2x1.5mm ²) or 3-core cable (R02V 3x1.5mm ²)
Type of wiring required	Parallel

LED DRIVERS

Product code	Input	SELV	Dimming	Bathroom zone	Min	Max
N/A (integrated SELV driver)	220-240V	SELV	Yes (mains)	1 (ceiling only)	N/A	N/A

ACCESSORIES

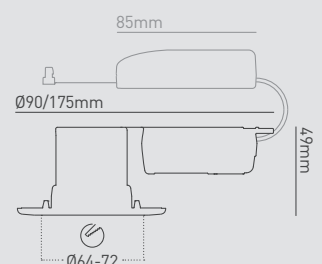
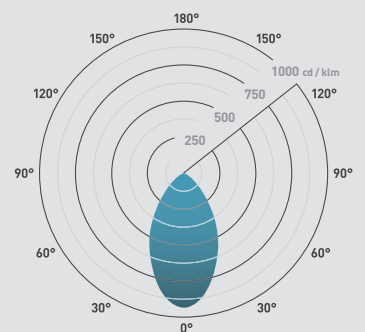

H2 range bezels	Round & square H2 Pro bezel options	Sold separately	98
DLCONVERT70	Converter plate	Sold separately	106
DM298GRID	LED mains grid dimmer	Sold separately	107
DM298FP	Faceplate dimmer	Sold separately	107
DLCVT110	Converter plate	Sold separately	106

Beam angle: 55°



Residential downlights.

01604 495 151
collingwoodlighting.com

 @collingwoodLED
 /collingwoodlighting
 collingwoodled

GUARANTEE / WARRANTY

7 year extended warranty

FEATURES & BENEFITS

- 3 colour temperatures in one product
- Easily choose CCT with standard wall switch or dimmer
- High efficacy of up to 94lm/W
- Only 6.4W
- Mains dimmable
- Push-fit terminal connector included
- Slimline twist & lock bezels (sold separately)
- Flexible driver position for easy installation
- Shallow depth of 49mm
- 90lm/W+

Beam angle: 65°

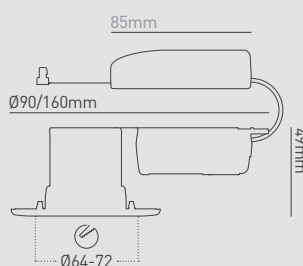
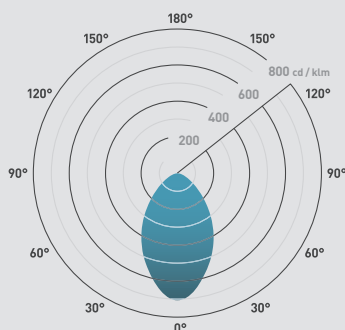

H2 Pro 550 CS

Colour switchable, dimmable, fire-rated downlight

FEATURES

Wattage	6.4W
IP rating	IP65
Colour flexibility	Colour switchable
Tilttable	No
UGR	-
Dimmable	Yes
Input	Mains AC
LED lifetime	70,000h L70, B10
SDCM	3SDCM
Flicker free	Yes
Emergency version available	Yes

INSTALLATION INFORMATION

Install connector type	Push-fit terminal connector
Insulation coverable	All insulation
Cut out size	Ø 64-72mm
Bathroom zone	1
Inrush current	1.1A 0.02ms
Construction material	Mild steel / VO rated plastic insulation protector built in
Maximum ceiling thickness	40mm
Weight	186g
Maximum ambient temperature	40°C
SELV	Yes
Building regulations	Part B, C, E, P, L
Electric class (1, 2, 3)	2

PHOTOMETRICS @ 25°C

Product code	Emergency	Colour	Beam angle	CRI	lm	lm/W	lx at 1m
DLT4286500	Non-emergency	6500K	65°	>80Ra	600	94	486
		4000K	65°	>80Ra	600	94	486
		3000K	65°	>80Ra	575	90	446
DLT4286500EM	Emergency	6500K	65°	>80Ra	600	94	486
		4000K	65°	>80Ra	600	94	486
		3000K	65°	>80Ra	575	90	446

WIRING INFORMATION

Cable / flying lead	0.15m
Cable required for connector	Push-fit terminal for: Twin & Earth (6242Y 2x1.5mm ²) or 3-core cable (R02V 3x1.5mm ²)
Type of wiring required	Parallel

LED DRIVERS

Product code	Input	SELV	Dimming	Bathroom zone	Min	Max
N/A (integrated SELV driver)	220-240V	SELV	Yes (mains)	1 (ceiling only)	N/A	N/A

ACCESSORIES

H2 range bezels	Round & square H2 Pro bezel options	Sold separately	98
DLCONVERT70	Converter plate	Sold separately	106
DM298GRID	Grid Dimmer	Sold separately	107
LEDEP06	LED emergency pack	Sold separately	107
DLCVT110	Converter plate	Sold separately	106

Residential downlights.

01604 495 151
collingwoodlighting.com

 @collingwoodLED

 /collingwoodlighting

 collingwoodled

GUARANTEE / WARRANTY

7 year extended warranty

FEATURES & BENEFITS

Easy-fit connector

IP65 rated

Mains dimmable as standard

Uses single point source technology to replicate traditional halogen look

55° beam angle offers superior illumination and allows for larger spacing between downlights

High lumen output suitable for high ceilings

Slimline twist & lock bezels (sold separately)

Includes Easy-fit connector

Mains dimmable

Only 7W

100lm/W+

Beam angle: 55°

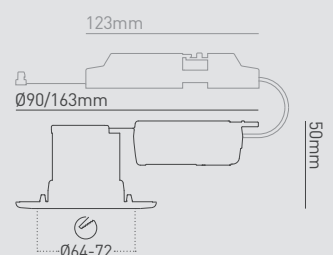
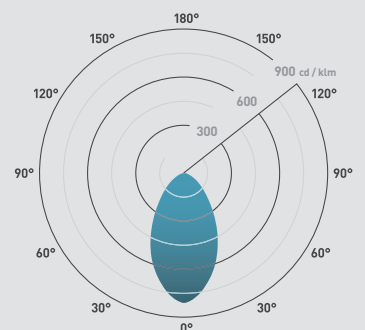

H2 Pro 700

Dimmable, fire-rated downlight with Easy-fit connector

FEATURES

Wattage	7W
IP rating	IP65
Colour flexibility	Fixed colour
Tilttable	No
UGR	22
Dimmable	Yes
Input	Mains AC
LED lifetime	70,000h L70 B10
SDCM	3SDCM
Flicker free	Yes
Emergency version available	Yes

INSTALLATION INFORMATION

Install connector type	Easy-fit connector
Insulation coverable	No
Cut out size	Ø 64-72mm
Bathroom zone	1
Inrush current	1.6A 0.1ms
Construction material	Mild steel / aluminium / pc v0 rated
Maximum ceiling thickness	40mm
Weight	360g
Maximum ambient temperature	40°C
SELV	Yes
Building regulations	Part B, C, E, P, L
Electric class [1, 2, 3]	2

PHOTOMETRICS @ 25°C

Product code	Emergency	Colour	Beam angle	CRI	lm	lm/W	Lx at 1m
DLE4795540	Non-emergency	4000K	55°	>80Ra	750	107	604
DLE4795530	Non-emergency	3000K	55°	>80Ra	700	100	564
DLE4795527	Non-emergency	2700K	55°	>80Ra	700	100	564
DLE4795540EM	Emergency	4000K	55°	>80Ra	750	107	604
DLE4795530EM	Emergency	3000K	55°	>80Ra	700	100	564
DLE4795527EM	Emergency	2700K	55°	>80Ra	700	100	564

WIRING INFORMATION

Cable / flying lead	0.15m
Cable required for connector	Push-fit terminal for: Twin & Earth (6242Y 2x1.5mm ²) or 3-core cable (R02V 3x1.5mm ²)
Type of wiring required	Parallel

LED DRIVERS



Product code	Input	SELV	Dimming	Bathroom zone	Min	Max
N/A (integrated SELV driver)	220-240V	SELV	Yes (mains)	1 (ceiling only)	N/A	N/A

ACCESSORIES

H2 range bezels	Round and square bezel options	Sold separately	98
DLCONVERT70	Converter plate	Sold separately	106
DM298GRID	LED mains grid dimmer	Sold separately	107
DM298FP	Faceplate dimmer	Sold separately	107
DLCVT110	Converter plate	Sold separately	106

Residential downlights.

01604 495 151
collingwoodlighting.com

-  @collingwoodLED
-  /collingwoodlighting
-  collingwoodled

GUARANTEE / WARRANTY

7 year extended warranty

FEATURES & BENEFITS

Dim to warm technology creates warmer environments by reducing the colour temperature during dimming

Uses single point source technology to replicate traditional halogen look

55° beam angle offers superior illumination and allows for larger spacing between downlights

Push-fit terminal connector included

Slimline twist & lock bezels (sold separately)

Flexible driver position for easy installation

Mains dimmable with leading edge dimmers

Shallow depth of 53mm

Only 8.2W

Beam angle: 55°

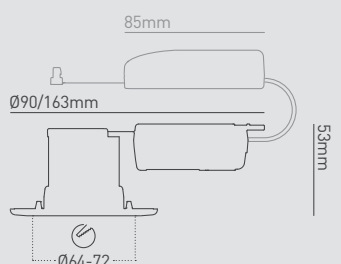
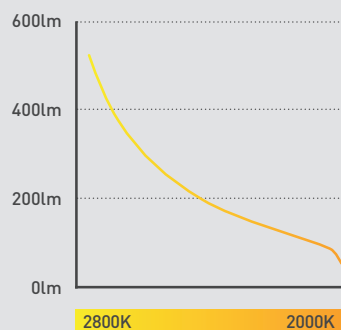

H2 Pro Dusk

Dim to warm, fire-rated downlight

FEATURES

Wattage	8.2W
IP rating	IP65
Colour flexibility	Dim to warm
Tilttable	No
UGR	22
Dimmable	Yes
Input	Mains AC
LED lifetime	70,000h L70 B10
SDCM	3SDCM
Flicker free	Yes
Emergency version available	Yes

INSTALLATION INFORMATION

Install connector type	Push-fit terminal connector
Insulation coverable	No
Cut out size	Ø 64-72mm
Bathroom zone	1
Inrush current	15.5A 0.2ms
Construction material	Mild steel / aluminium / pc v0 rated
Maximum ceiling thickness	40mm
Weight	272g
Maximum ambient temperature	40°C
SELV	Yes
Building regulations	Part B, C, E, P, L
Electric class (1, 2, 3)	2

PHOTOMETRICS @ 25°C

Product code	Emergency	Colour	Beam angle	CRI	lm	lm/W	lx at 1m
DLT2425528	Non-emergency	2000-2800K	55°	>80Ra	530	65	490
DLT2425528EM	Emergency	2000-2800K	55°	>80Ra	370	137	197

WIRING INFORMATION

Cable / flying lead	0.15m
Cable required for connector	Push-fit terminal for: Twin & Earth (6242Y 2x1.5mm ²) or 3-core cable (R02V 3x1.5mm ²)
Type of wiring required	Parallel

LED DRIVERS

Product code	Input	SELV	Dimming	Bathroom zone	Min	Max
N/A (integrated SELV driver)	220-240V	SELV	Yes (mains)	1 (ceiling only)	N/A	N/A

ACCESSORIES

H2 range bezels	Round and square bezel options	Sold separately	98
DLCONVERT70	Converter plate	Sold separately	106
DM298GRID	LED mains grid dimmer	Sold separately	107
DM298FP	Faceplate dimmer	Sold separately	107
DLCVT110	Converter plate	Sold separately	106

Residential downlights.

01604 495 151
collingwoodlighting.com

 @collingwoodLED

 /collingwoodlighting

 collingwoodled

GUARANTEE / WARRANTY

7 year extended warranty

FEATURES & BENEFITS

Low glare downlight - UGR 14
45° beam angle for wide illumination
Push-fit terminal connector included
Slimline twist & lock bezels (sold separately)
Shallow depth of 53mm
Flexible driver position for easy installation
Dim to warm option available
Mains dimmable



H2 Pro Elect

Low glare, dimmable, fire-rated downlight

FEATURES

Wattage	8.5W
IP rating	IP20
Colour flexibility	Fixed colour or Dim to warm
Tilttable	No
UGR	14
Dimmable	Yes
Input	Mains AC
LED lifetime	70,000h L70 B10
SDCM	3SDCM
Flicker free	Yes
Emergency version available	Yes

INSTALLATION INFORMATION

Install connector type	Push-fit terminal connector
Insulation coverable	No
Cut out size	Ø 64-72mm
Bathroom zone	1
Inrush current	1.4A 0.04ms
Construction material	Mild steel / aluminium / pc v0 rated
Maximum ceiling thickness	40mm
Weight	240g
Maximum ambient temperature	40°C
SELV	Yes
Building regulations	Part B, C, E, P, L
Electric class (1, 2, 3)	2

PHOTOMETRICS @ 25°C

Product code	Emergency	Colour	Beam angle	CRI	lm	lm/W	lx at 1m
DLT4074540	Non-emergency	4000K	45°	>80Ra	640	75	1077
DLT4074530	Non-emergency	3000K	45°	>80Ra	600	71	1009
DLT4074528	Non-emergency	1800-3000K	45°	>80Ra	380	46	588
DLT4074540EM	Emergency	4000K	45°	>80Ra	280	104	471
DLT4074530EM	Emergency	3000K	45°	>80Ra	260	96	437
DLT4074528EM	Emergency	1800-3000K	45°	>80Ra	180	67	278

WIRING INFORMATION

Cable / flying lead	0.15m
Cable required for connector	Push-fit terminal for: Twin & Earth (6242Y 2x1.5mm ²) or 3-core cable (R02V 3x1.5mm ²)
Type of wiring required	Parallel

LED DRIVERS

Product code	Input	SELV	Dimming	Bathroom zone	Min	Max
N/A (integrated SELV driver)	220-240V	SELV	Yes (mains)	1 (ceiling only)	N/A	N/A

ACCESSORIES

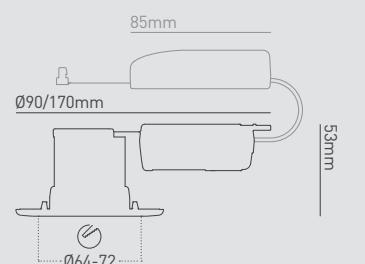
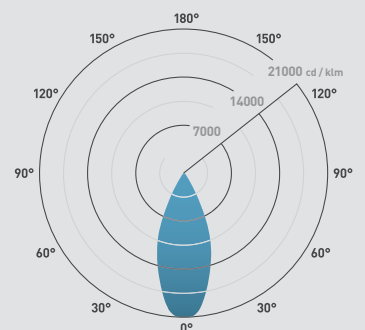

H2 range bezels	Round & square H2 Pro bezel options	Sold separately	98
DLCONVERT70	Converter plate	Sold separately	106
DM298GRID	LED mains grid dimmer	Sold separately	107
DLCVT110	Converter plate	Sold separately	106

Beam angle: 45°



Residential downlights.

01604 495 151
collingwoodlighting.com

 @collingwoodLED
 /collingwoodlighting
 collingwoodled

GUARANTEE / WARRANTY

7 year extended warranty

FEATURES & BENEFITS

Low glare downlight - UGR 14
45° beam angle for wide illumination
Plaster-in downlight
Flexible driver position for easy installation
Dim to warm option available
Mains dimmable

Beam angle: 45°

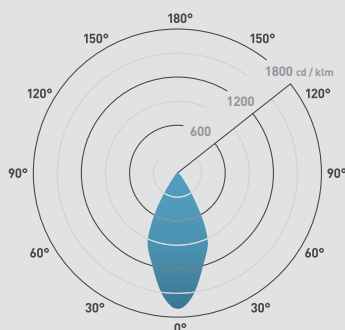

Ø114/172mm

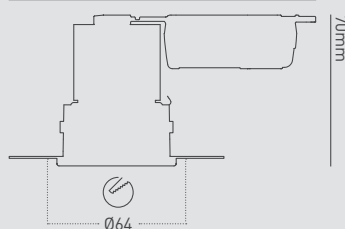

H2 Pro Elect Trimless

Low glare, trimless, dimmable, fire-rated downlight

FEATURES

Wattage	8.5W
IP rating	IP20
Colour flexibility	Fixed colour
Tilttable	No
UGR	14
Dimmable	Yes
Input	Mains AC
LED lifetime	70,000h L70, B10
SDCM	3SDCM
Flicker free	Yes
Emergency version available	Yes

INSTALLATION INFORMATION

Install connector type	Terminal connector
Insulation coverable	No
Cut out size	Ø 60-72mm
Bathroom zone	1
Inrush current	1.4A 0.04ms
Construction material	Mild steel / aluminium / pc v0 rated
Maximum ceiling thickness	40mm
Weight	240g
Maximum ambient temperature	40°C
SELV	Yes
Building regulations	Part B, C, E, P, L
Electric class (1, 2, 3)	2

PHOTOMETRICS @ 25°C

Product code	Emergency	Colour	Beam angle	CRI	lm	lm/W	lx at 1m
DL4094540	Non-emergency	4000K	45°	>80Ra	700	82	1178
DL4094530	Non-emergency	3000K	45°	>80Ra	650	76	1094
DL4094528	Non-emergency	1800-3000K	45°	>80Ra	380	54	588
DL4094540EM	Emergency	4000K	45°	>80Ra	300	115	505
DL4094530EM	Emergency	3000K	45°	>80Ra	280	108	471
DL4094528EM	Emergency	1800-3000K	45°	>80Ra	170	63	263

WIRING INFORMATION

Cable / flying lead	0.15m
Cable required for connector	Push-fit terminal for: Twin & Earth (6242Y 2x1.5mm ²) or 3-core cable (R02V 3x1.5mm ²)
Type of wiring required	Parallel

LED DRIVERS

Product code	Input	SELV	Dimming	Bathroom zone	Min	Max
N/A (integrated SELV driver)	220-240V	SELV	Yes (mains)	1 (ceiling only)	N/A	N/A

ACCESSORIES

DM298GRID	LED mains grid dimmer	Sold separately	107
DM298FP	Faceplate dimmer	Sold separately	107
LEDEP06	LED emergency pack	Sold separately	109

Residential downlights.

01604 495 151
collingwoodlighting.com

 @collingwoodLED

 /collingwoodlighting

 collingwoodled

GUARANTEE / WARRANTY

4 year extended warranty

FEATURES & BENEFITS

IP65 from the front and back ensuring complete protection against the elements
38° beam angle
Dimmable for ultimate flexibility
Corrosion resistant technology
Complete with integrated matt white bezel
100lm/W+



H2 Pro Extreme

IP65 outdoor downlight with waterproof seal

FEATURES

Wattage	4.6W
IP rating	IP65
Colour flexibility	Fixed colour
Tilttable	No
UGR	22
Dimmable	Yes
Input	Mains AC
LED lifetime	40,000h L70 B10
SDCM	3SDCM
Flicker free	Yes
Emergency version available	No

INSTALLATION INFORMATION

Install connector type	Flying lead
Insulation coverable	No
Cut out size	Ø 65-75mm
Bathroom zone	1
Inrush current	1.0A 0.25ms
Construction material	Aluminium / VO rated plastic
Maximum ceiling thickness	30mm
Weight	185g
Maximum ambient temperature	40°C
SELV	Yes
Building regulations	Part P, L
Electric class [1, 2, 3]	2

PHOTOMETRICS @ 25°C

Product code	Finish	Colour	Beam angle	CRI	lm	lm/W	Lx at 1m
DL48938MW40	Matt White	4000K	38°	>80Ra	490	107	873
DL48938MW30	Matt White	3000K	38°	>80Ra	460	100	820

WIRING INFORMATION

Cable / flying lead	0.15m
Cable required for connector	N/A
Type of wiring required	Parallel

LED DRIVERS

Product code	Input	SELV	Dimming	Bathroom zone	Min	Max
N/A (integrated SELV driver)	220-240V	SELV	Yes (mains)	1 (ceiling only)	N/A	N/A

ACCESSORIES

DM298GRID	Grid Dimmer	Sold separately	107
DM298FP	Flatplate Dimmer	Sold separately	107

Beam angle: 38°

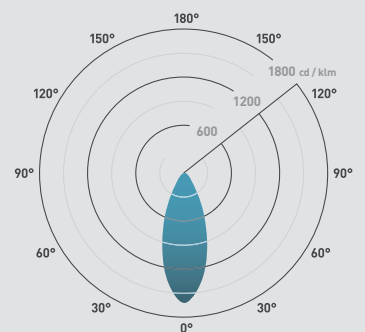

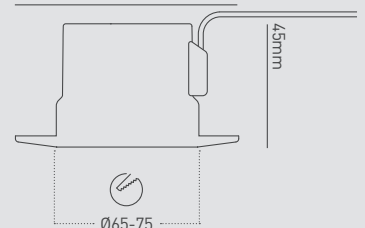

Ø90mm



Residential downlights.

01604 495 151
collingwoodlighting.com

 @collingwoodLED
 /collingwoodlighting
 collingwoodled

GUARANTEE / WARRANTY

Covered as part of the H2 range warranty

FEATURES & BENEFITS

Twist & lock system makes interchanging bezels quick, clean and easy

Can be fitted after decoration is complete

Matt white and black bezels can be painted with a wide range of paints designed for domestic ceiling use

Sold in multiples of two

Ø90mm

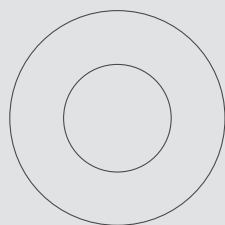

90x90mm

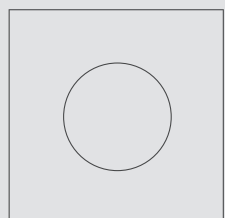

H2 bezels

Twist & lock system makes changing bezels quick, clean and easy

FEATURES

Construction material Plastic

PRODUCT CODE

Product code	Finish	Description
RB359BLK	Black	Round matt black bezel
SQB360BLK	Black	Square matt black bezel
RB359BS	Brushed steel	Round brushed steel bezel
RB359CR	Chrome	Round chrome bezel
SQB360CR	Chrome	Square chrome bezel
RB359WH	Gloss white	Round white bezel
RB359MW	Matt white	Round matt white bezel
SQB360MW	Matt white	Square matt white bezel
RB359PG	Polished gold	Round polished gold bezel
SQB360PG	Polished gold	Square polished gold bezel
RB359SIL	Silver	Round silver bezel
SQB360SIL	Silver	Square silver bezel

USE WITH

H2 downlight range Pages 84 - 95



H4 Pro 550

±20° adjustable downlight with twist & lock bezel

FEATURES

Wattage	5.2W
IP rating	IP65
Colour flexibility	Fixed colour
Tilttable	20°
UGR	16
Dimmable	Yes
Input	Mains AC
LED lifetime	70,000h L70 B10
SDCM	3SDCM
Flicker free	Yes
Emergency version available	Yes

INSTALLATION INFORMATION

Install connector type	Easy-fit connector
Insulation coverable	All insulation
Cut out size	Ø 69-72mm
Bathroom zone	1
Inrush current	0.9A 0.04ms
Construction material	Mild steel / VO rated plastic insulation protector built in
Maximum ceiling thickness	40mm
Weight	246g
Maximum ambient temperature	40°C
SELV	Yes
Building regulations	Part B, C, E, P, L
Electric class (1, 2, 3)	2

PHOTOMETRICS @ 25°C

Product code	Emergency	Colour	Beam angle	CRI	lm	lm/W	lx at 1m
DLE4357040	Non-emergency	4000K	70°	>80Ra	580	112	496
DLE4353840	Non-emergency	4000K	38°	>80Ra	580	112	1237
DLE4357030	Non-emergency	3000K	70°	>80Ra	550	106	462
DLE4353830	Non-emergency	3000K	38°	>80Ra	550	106	1173
DLE4357040EM	Emergency	4000K	70°	>80Ra	580	112	496
DLE4353840EM	Emergency	4000K	38°	>80Ra	580	112	1237
DLE4357030EM	Emergency	3000K	70°	>80Ra	550	106	462
DLE4353830EM	Emergency	3000K	38°	>80Ra	550	106	1173

WIRING INFORMATION

Cable / flying lead	0.15m
Cable required for connector	Push-fit terminal for: Twin & Earth (6242Y 2x1.5mm ²) or 3-core cable (R02V 3x1.5mm ²)
Type of wiring required	Parallel

LED DRIVERS

Product code	Input	SELV	Dimming	Bathroom zone	Min	Max
N/A (integrated SELV driver)	220-240V	SELV	Yes (mains)	1 (ceiling only)	N/A	N/A

ACCESSORIES

H4 Pro range bezels	Round H4 Pro bezel options	Sold separately	104
DLCONVERT70 & DLCVT110	Converter plates	Sold separately	106
DM298GRID & DM298FP	Grid Dimmer & Flatplate Dimmer	Sold separately	107

Residential downlights.

01604 495 151
collingwoodlighting.com

- @collingwoodLED
- /collingwoodlighting
- collingwoodled

GUARANTEE / WARRANTY

7 year extended warranty

FEATURES & BENEFITS

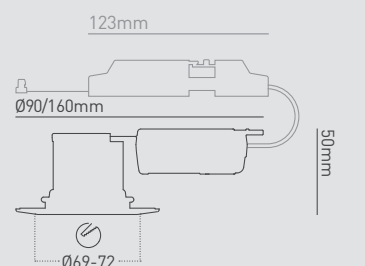
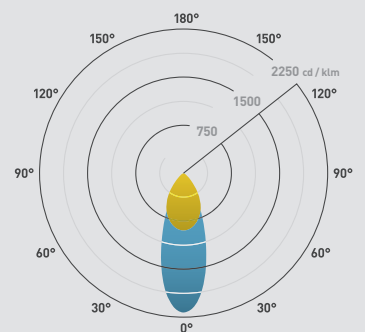

- 106lm/W+
- Slimline twist & lock bezels (sold separately)
- Shallow depth of 50mm
- Insulation coverable
- Push-fit terminal connector included
- Only 5.2W
- Flexible driver position for easy installation
- Mains dimmable

Beam angle: 38° 70°



Residential downlights.

01604 495 151
collingwoodlighting.com

 @collingwoodLED
 /collingwoodlighting
 collingwoodled

GUARANTEE / WARRANTY

7 year extended warranty

FEATURES & BENEFITS

- 106lm/W+
- Slimline twist & lock bezels (sold separately)
- Shallow depth of 50mm
- Insulation coverable
- Push-fit terminal connector included
- Only 5.2W
- DALI dimmable

Beam angle: 38° 70°

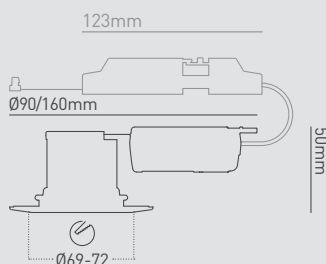
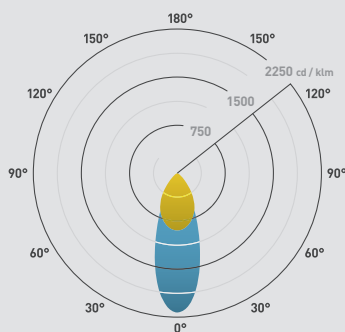

100



H4 Pro 550 DALI

±20° adjustable downlight with twist & lock bezel

FEATURES

Wattage	5.2W
IP rating	IP65
Colour flexibility	Fixed colour
Tilttable	20°
UGR	16
Dimmable	Yes
Input	Mains AC
LED lifetime	70,000h L70 B10
SDCM	3SDCM
Flicker free	Yes
Emergency version available	Yes

INSTALLATION INFORMATION

Install connector type	Easy-fit connector
Insulation coverable	All insulation
Cut out size	Ø 69-72mm
Bathroom zone	1
Inrush current	0.9A 0.04ms
Construction material	Mild steel / VO rated plastic insulation protector built in
Maximum ceiling thickness	40mm
Weight	246g
Maximum ambient temperature	40°C
SELV	Yes
Building regulations	Part B, C, E, P, L
Electric class [1, 2, 3]	2

PHOTOMETRICS @ 25°C

Product code	Emergency	Colour	Beam angle	CRI	lm	lm/W	lx at 1m
DLE4357040D	Non-emergency	4000K	70°	>80Ra	580	112	496
DLE4353840D	Non-emergency	4000K	38°	>80Ra	580	112	1237
DLE4357030D	Non-emergency	3000K	70°	>80Ra	550	106	462
DLE4353830D	Non-emergency	3000K	38°	>80Ra	550	106	1173
DLE4357040DEM	Emergency	4000K	70°	>80Ra	580	112	496
DLE4353840DEM	Emergency	4000K	38°	>80Ra	580	112	1237
DLE4357030DEM	Emergency	3000K	70°	>80Ra	550	106	462
DLE4353830DEM	Emergency	3000K	38°	>80Ra	550	106	1173

WIRING INFORMATION

Cable / flying lead	0.15m
Cable required for connector	Push-fit terminal for: Twin & Earth (6242Y 2x1.5mm ²) or 3-core cable (R02V 3x1.5mm ²)
Type of wiring required	Parallel

LED DRIVERS

Product code	Input	SELV	Dimming	Bathroom zone	Min	Max
N/A (integrated SELV driver)	220-240V	SELV	Yes (DALI)	1 (ceiling only)	N/A	N/A



ACCESSORIES

H4 Pro range bezels	Round H4 Pro bezel options	Sold separately	104
DLCONVERT70	Converter plate	Sold separately	106
DLCVT110	Converter plate	Sold separately	106



Residential downlights.

01604 495 151
collingwoodlighting.com

-  @collingwoodLED
-  /collingwoodlighting
-  collingwoodled

H4 Pro 550 SPS

±20° adjustable, single point source, dimmable, fire-rated downlight

FEATURES

Wattage	5W
IP rating	IP65
Colour flexibility	Fixed colour
Tilttable	20°
UGR	-
Dimmable	Yes
Input	Mains AC
LED lifetime	70,000h L70, B10
SDCM	3SDCM
Flicker free	Yes
Emergency version available	Yes

INSTALLATION INFORMATION

Install connector type	Push-fit terminal connector
Insulation coverable	All insulation
Cut out size	Ø 69-72mm
Bathroom zone	1
Inrush current	1.2A 0.03ms
Construction material	Mild steel / VO rated plastic insulation protector built in
Maximum ceiling thickness	40mm
Weight	243g
Maximum ambient temperature	40°C
SELV	Yes
Building regulations	Part B, C, E, P, L
Electric class [1, 2, 3]	2

GUARANTEE / WARRANTY

7 year extended warranty

FEATURES & BENEFITS

±20° adjustable downlight to adjust direction of light

110lm/W+

Slimline twist & lock bezels (sold separately)

Shallow depth of 50mm

Insulation coverable

Uses single point source technology to replicate traditional halogen look

Flexible driver position for easy installation

Only 5W

Mains dimmable

PHOTOMETRICS @ 25°C

Product code	Emergency	Colour	Beam angle	CRI	lm	lm/W	Lx at 1m
DLT4365540	Non-emergency	4000K	55°	>80Ra	560	112	516
DLT4365530	Non-emergency	3000K	55°	>80Ra	550	110	506
DLT4365540EM	Emergency	4000K	55°	>80Ra	390	156	359
DLT4365530EM	Emergency	3000K	55°	>80Ra	370	148	341

WIRING INFORMATION

Cable / flying lead	0.15m
Cable required for connector	Push-fit terminal for: Twin & Earth (6242Y 2x1.5mm ²) or 3-core cable (R02V 3x1.5mm ²)
Type of wiring required	Parallel

LED DRIVERS

Product code	Input	SELV	Dimming	Bathroom zone	Min	Max
N/A (integrated SELV driver)	220-240V	SELV	Yes (mains)	1 (ceiling only)	N/A	N/A

ACCESSORIES

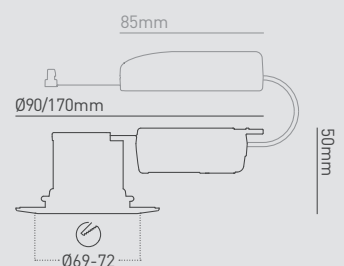
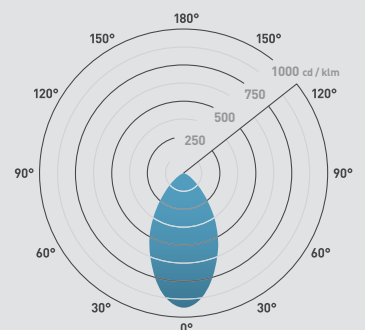

H4 Pro range bezels	Round H4 Pro bezel options	Sold separately	104
DLCONVERT70	Converter plate	Sold separately	106
DM298GRID	LED mains grid dimmer	Sold separately	107
DM298FP	Faceplate dimmer	Sold separately	107
DLCVT110	Converter plate	Sold separately	106

Beam angle: 55°



Residential downlights.

01604 495 151
collingwoodlighting.com

 @collingwoodLED
 /collingwoodlighting
 collingwoodled

GUARANTEE / WARRANTY

7 year extended warranty

FEATURES & BENEFITS

±20° adjustable downlight to adjust direction of light

100lm/W+

Uses single point source technology to replicate traditional halogen look

55° beam angle offers superior illumination and allows for larger spacing between downlights

High lumen output suitable for high ceilings

Shallow depth of 50mm

Push-fit terminal connector included

Slimline twist & lock bezels (sold separately)

Flexible driver position for easy installation

Mains dimmable

Only 7W

Beam angle: 55°

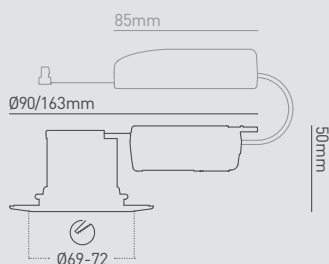
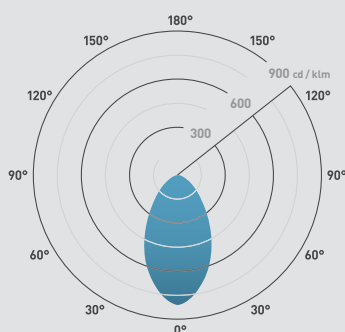

H4 Pro 700

±20° adjustable, dimmable, fire-rated downlight

FEATURES

Wattage	7W
IP rating	IP65
Colour flexibility	Fixed colour
Tilttable	20°
UGR	-
Dimmable	Yes
Input	Mains AC
LED lifetime	70,000h L70, B10
SDCM	3SDCM
Flicker free	Yes
Emergency version available	Yes

INSTALLATION INFORMATION

Install connector type	Push-fit terminal connector
Insulation coverable	No
Cut out size	Ø 69-72mm
Bathroom zone	1
Inrush current	0.9A 0.03ms
Construction material	Mild steel / aluminium / pc v0 rated
Maximum ceiling thickness	40mm
Weight	300g
Maximum ambient temperature	40°C
SELV	Yes
Building regulations	Part B, C, E, P, L
Electric class [1, 2, 3]	2

PHOTOMETRICS @ 25°C

Product code	Emergency	Colour	Beam angle	CRI	lm	lm/W	lx at 1m
DLT4435540	Non-emergency	4000K	55°	>80Ra	750	107	604
DLT4435530	Non-emergency	3000K	55°	>80Ra	700	100	564
DLT4435527	Non-emergency	2700K	55°	>80Ra	700	100	564
DLT4435540EM	Emergency	4000K	55°	>80Ra	400	148	322
DLT4435530EM	Emergency	3000K	55°	>80Ra	370	142	298
DLT4435527EM	Emergency	2700K	55°	>80Ra	370	142	298

WIRING INFORMATION

Cable / flying lead	0.15m
Cable required for connector	Push-fit terminal for: Twin & Earth (6242Y 2x1.5mm ²) or 3-core cable (R02V 3x1.5mm ²)
Type of wiring required	Parallel

LED DRIVERS

Product code	Input	SELV	Dimming	Bathroom zone	Min	Max
N/A (integrated SELV driver)	220-240V	SELV	Yes (mains)	1 (ceiling only)	N/A	N/A

ACCESSORIES

H4 Pro range bezels	Round H4 Pro bezel options	Sold separately	104
DLCONVERT70	Converter plate	Sold separately	106
DM298GRID	LED mains grid dimmer	Sold separately	107
DM298FP	Faceplate dimmer	Sold separately	107
DLCVT110	Converter plate	Sold separately	106



Residential downlights.

01604 495 151
collingwoodlighting.com

 @collingwoodLED

 /collingwoodlighting

 collingwoodled

H4 Pro Elect

±20° adjustable, low glare, dimmable, fire-rated downlight

FEATURES

Wattage	8.5W
IP rating	IP20
Colour flexibility	Fixed colour or Dim to warm
Tilttable	20°
UGR	14
Dimmable	Yes
Input	Mains AC
LED lifetime	70,000h L70, B10
SDCM	3SDCM
Flicker free	Yes
Emergency version available	Yes

INSTALLATION INFORMATION

Install connector type	Push-fit terminal connector
Insulation coverable	No
Cut out size	Ø 69-72mm
Bathroom zone	1
Inrush current	1.4A 0.04ms
Construction material	Mild steel / aluminium / pc v0 rated
Maximum ceiling thickness	40mm
Weight	275g
Maximum ambient temperature	40°C
SELV	Yes
Building regulations	Part B, C, E, P, L
Electric class (1, 2, 3)	2

GUARANTEE / WARRANTY

7 year extended warranty

FEATURES & BENEFITS

±20° adjustable downlight to adjust direction of light

Low glare downlight - UGR 14

45° beam angle for wide illumination

Push-fit terminal connector included

Slimline twist & lock bezels (sold separately)

Dim to warm option available

Shallow depth of 56mm

Flexible driver position for easy installation

Mains dimmable

Up to 103lm/W

PHOTOMETRICS @ 25°C

Product code	Emergency	Colour	Beam angle	CRI	lm	lm/W	lx at 1m
DLT4414540	Non-emergency	4000K	45°	>80Ra	700	82	1178
DLT4414530	Non-emergency	3000K	45°	>80Ra	650	76	1094
DLT4414528	Non-emergency	1800-3000K	45°	>90Ra	380	54	588
DLT4414540EM	Emergency	4000K	45°	>80Ra	300	103	505
DLT4414530EM	Emergency	3000K	45°	>80Ra	280	96	471
DLT4414528EM	Emergency	1800-3000K	45°	>80Ra	180	67	278

WIRING INFORMATION

Cable / flying lead	0.15m
Cable required for connector	Push-fit terminal for: Twin & Earth (6242Y 2x1.5mm ²) or 3-core cable (R02V 3x1.5mm ²)
Type of wiring required	Parallel

LED DRIVERS

Product code	Input	SELV	Dimming	Bathroom zone	Min	Max
N/A (integrated SELV driver)	220-240V	SELV	Yes (mains)	1 (ceiling only)	N/A	N/A

ACCESSORIES

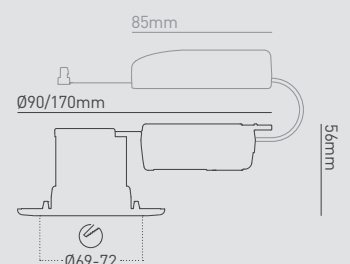
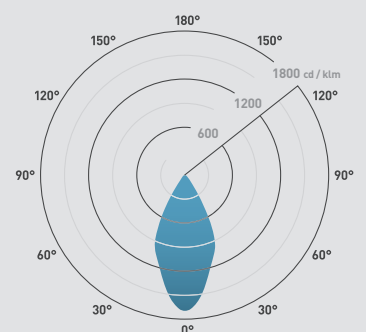

H4 Pro range bezels	Round H4 Pro bezel options	Sold separately	104
DLCONVERT70	Converter plate	Sold separately	106
DM298GRID	LED mains grid dimmer	Sold separately	107
DM298FP	Faceplate dimmer	Sold separately	107
DLCVT110	Converter plate	Sold separately	106

Beam angle: 45°



Residential downlights.

01604 495 151
collingwoodlighting.com

 @collingwoodLED
 /collingwoodlighting
 collingwoodled

GUARANTEE / WARRANTY

Covered as part of the H4 Pro range warranty

FEATURES & BENEFITS

Twist & lock system makes interchanging bezels quick, clean and easy

Can be fitted after decoration is complete

Matt white bezels can be painted with a wide range of paints designed for domestic ceiling use

Sold in multiples of two

Ø90mm

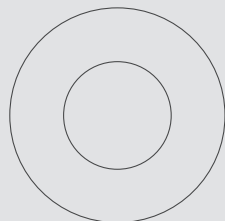

90x90mm

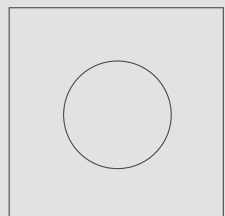

H4 bezels

Twist & lock system makes changing bezels quick, clean and easy

FEATURES

Construction material Plastic

PRODUCT CODE



Product code	Finish	Description
RB442BS	Brushed steel	Round brushed steel bezel
RB442CR	Chrome	Round chrome bezel
RB442WH	Gloss white	Round white bezel
RB442MW	Matt white	Round matt white bezel

USE WITH

H4 downlight range Pages 99 - 103

Residential downlights.

01604 495 151
collingwoodlighting.com

-  @collingwoodLED
-  /collingwoodlighting
-  collingwoodled

GUARANTEE / WARRANTY

7 year extended warranty

FEATURES & BENEFITS

- 100lm/W+
- Only 5.5W
- Mains dimmable
- Plaster-in downlight
- Recessed fitting for lower glare rating
- Flexible driver position for easy installation



H5 Trimless

Plaster-in, trimless, dimmable, fire-rated downlight

FEATURES

Wattage	5.5W
IP rating	IP65
Colour flexibility	Fixed colour
Tilttable	No
UGR	14
Dimmable	Yes
Input	Mains AC
LED lifetime	70,000h L70 B10
SDCM	3SDCM
Flicker free	Yes
Emergency version available	No

INSTALLATION INFORMATION

Install connector type	Easy-fit connector
Insulation coverable	All insulation
Cut out size	Ø 60-72mm
Bathroom zone	1
Inrush current	0.9A 0.05ms
Construction material	Mild steel / VO rated plastic insulation protector built in
Maximum ceiling thickness	40mm
Weight	240g
Maximum ambient temperature	40°C
SELV	Yes
Building regulations	Part B, C, E, P, L
Electric class (1, 2, 3)	2

PHOTOMETRICS @ 25°C

Product code	Finish	Colour	Beam angle	CRI	lm	lm/W	lx at 1m
DL282WHNWDIM	Matt white	4000K	38°	>80Ra	580	105	1241
DL282WHWWDIM	Matt white	3000K	38°	>80Ra	550	100	1177

WIRING INFORMATION

Cable / flying lead	0.15m
Cable required for connector	Push-fit terminal for: Twin & Earth (6242Y 2x1.5mm ²) or 3-core cable (R02V 3x1.5mm ²)
Type of wiring required	Parallel

LED DRIVERS

Product code	Input	SELV	Dimming	Bathroom zone	Min	Max
N/A (integrated SELV driver)	220-240V	SELV	Yes (mains)	1 (ceiling only)	N/A	N/A

ACCESSORIES

DM298GRID	LED mains grid dimmer	Sold separately	107
DM298FP	Faceplate dimmer	Sold separately	107

Beam angle: 38°

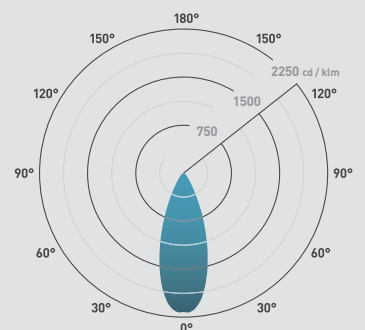

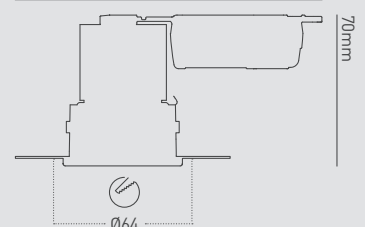

Ø114/172mm



Residential downlights.

01604 495 151
collingwoodlighting.com

 @collingwoodLED
 /collingwoodlighting
 collingwoodled

GUARANTEE / WARRANTY

1 year guarantee

FEATURES & BENEFITS

DL/CONVERT / DLCONVERT70 / DLCONVERT98 supplied with additional springs for holes up to 150mm

Can be used to conceal ceiling cutout that is larger than the diameter of a downlight

DL/CONVERT | DLCONVERT70

Ø170mm

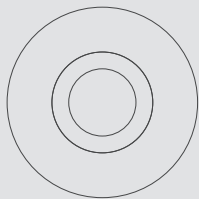

DLCONVERT98

Ø170mm

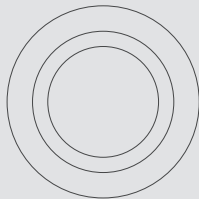

DLCVT110

Ø110mm

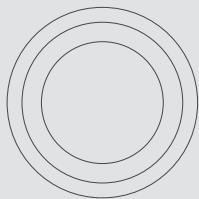

DL801MW

Ø319mm

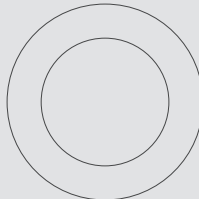

DLCONVERT

Hole converter plates for the downlight range

INSTALLATION INFORMATION

Cut out size	Ø 60 - 290mm
Construction material	Mild steel
Maximum ceiling thickness	DLCONVERT, 70, 98 & 110: 35mm DL801MW: 20mm
Weight	55 - 380g

Note: Downlight fire and IP ratings will not apply if used in conjunction with DLCONVERT range.

PRODUCT CODE

Product code	Finish	Description	Cut out (mm)
DL/CONVERTBLK	Black	Hole converter plates for the H2 Pro ranges	Ø 60 - 150
DLCONVERT70BS	Brushed steel	Hole converter plates for the H2 Pro/H4 Pro/H2 Lite ranges	Ø 63 - 150
DLCONVERT98BS	Brushed steel	Hole converter plates for H5 500/H5 1000 Ø170mm	Ø 98 - 150
DL/CONVERTCR	Chrome	Hole converter plates for the H2 Pro/H4 Pro/H2 Lite ranges	Ø 60 - 150
DLCONVERT70CR	Chrome	Hole converter plates for the H2 Pro/H4 Pro/H2 Lite ranges	Ø 63 - 150
DLCONVERT98CR	Chrome	Hole converter plates for H5 500/H5 1000	Ø 98 - 150
DLCONVERT70PG	Polished gold	Hole converter plates for the H2 Pro ranges Ø170mm	Ø 60 - 150
DL/CONVERTSIL	Silver	Hole converter plates for the H2 Pro ranges Ø170mm	Ø 60 - 150
DLCONVERT70WH	Gloss white	Hole converter plates for the H2 Pro/H4 Pro/H2 Lite ranges	Ø 63 - 150
DLCONVERT98WH	Gloss white	Hole converter plates for H5 500/H5 1000	Ø 98 - 150
DLCONVERT70MW	Matt white	Hole converter plates for the H2 Pro/H4 Pro/H2 Lite ranges	Ø 70 - 150
DLCVT110MW	Matt white	Hole converter plates for the H2 Pro/H4 Pro/H2 Lite ranges	Ø 72 - 95
DLCVT110BS	Brushed Steel	Hole converter plates for the H2 Pro/H4 Pro/H2 Lite ranges	Ø 72 - 95
DLCVT110CR	Chrome	Hole converter plates for the H2 Pro/H4 Pro/H2 Lite ranges	Ø 72 - 95
DLCVT110WH	Gloss white	Hole converter plates for the H2 Pro/H4 Pro/H2 Lite ranges	Ø 72 - 95
DL801MW	Matt white	Hole converter plates for CDL0124/CDL0132 range	Ø 240 - 290

USE WITH

H2 downlight range	Pages 84 - 95
H4 downlight range	Pages 99 - 103



DM298GRID

LED mains grid dimmer

FEATURES

Product code	DM298GRID
Construction material	Plastic
Dimmer type	Push on / off, rotary dial dim
Grid plate adaptors	White adaptors for Hamilton, MK, BG, Crabtree, Schneider, DETA, Hager & Wandsworth grid ranges
Mains supply voltage	240V AC
Mains supply voltage range	230V AC - 240V AC
Mains supply frequency	50Hz
Load type	LED dimmable driver only
Minimum load capacity	5W
Maximum load capacity	100W / 10 LED units max.
Phase firing	Trailing edge dimming
Connection terminals	3mm ² max.
Back box depth	35mm min.
Surface temperature	40°C

USE WITH

H2 Lite
H2 Lite 500
H2 Lite 500 CSW
H2 Lite 500 CSP
H2 Pro 550
H2 Pro 550 SPS
H2 Pro 550 CS
H2 Pro 700
H2 Pro Elect
H2 Pro Elect Trimless
H4 Lite
H4 Pro 550
H4 Pro 550 SPS
H4 Pro 700
H4 Pro Elect
H5 Trimless
DL120 / DL130
FIBRE LED LIGHT
RL111
DM02

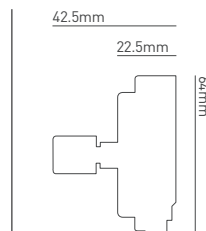

DM298FP

Faceplate dimmer

FEATURES

Product Code	DM298FP
Construction material	Plastic
Dimmer type	Push on / off, rotary dial dim
Grid plate adaptors	-
Mains supply voltage	240V AC
Mains supply voltage range	230V AC - 240V AC
Mains supply frequency	50Hz
Load type	LED dimmable driver only
Minimum load capacity	5W
Maximum load capacity	100W / 10 LED units max.
Phase firing	Trailing edge dimming
Connection terminals	3mm ² max.
Back box depth	35mm min.
Surface temperature	40°C

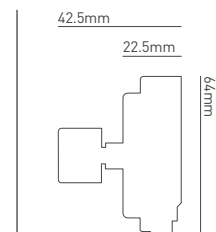

USE WITH

H2 Lite
H2 Lite 500
H2 Lite 500 CSW
H2 Lite 500 CSP
H2 Pro 550
H2 Pro 550 SPS
H2 Pro 550 CS
H2 Pro 700
H2 Pro Elect
H2 Pro Elect Trimless
H4 Lite
H4 Pro 550
H4 Pro 550 SPS
H4 Pro 700
H4 Pro Elect
H5 Trimless
DL120 / DL130
FIBRE LED LIGHT
RL111
DM02



Residential downlights.

01604 495 151
collingwoodlighting.com

 @collingwoodLED
 /collingwoodlighting
 collingwoodled

GUARANTEE / WARRANTY

1 year extended warranty

FEATURES & BENEFITS

Large piano key push-in wire connectors, ideal for a quick and easy installation

Suitable for new installations and retrofit

Loop-in loop-out terminals reducing installation time

Minimises the risk of damage to fittings during installation or decorating

Plug & play

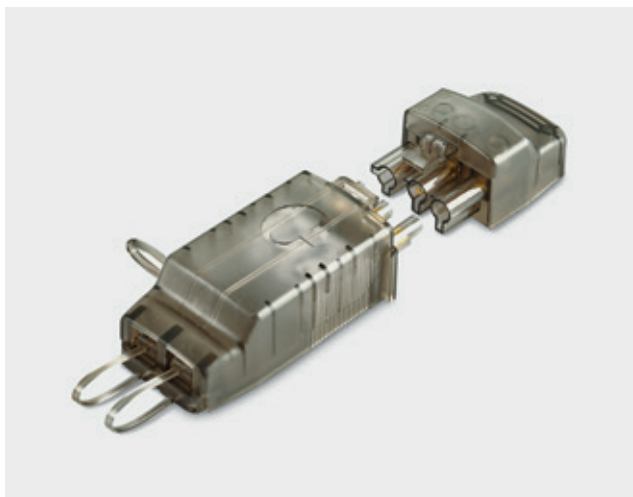

Easy-fit connector

First fix, push-in connector

INSTALLATION INFORMATION

Construction material	PC
Weight	230g

PRODUCT CODE

Product code	Description
EFC3P	First fix, push-in connector (20 units per box)

WIRING INFORMATION

Cable required for connector	Twin & Earth or 3 core cable (R02V 3x 1.5mm ²)
------------------------------	--

USE WITH

Residential Downlights	Can be used in conjunction with Collingwood residential downlights*
------------------------	---

*Excluding H2 Lite 500 CSP and 400 CSP



Residential downlights.

01604 495 151
collingwoodlighting.com

 @collingwoodLED

 /collingwoodlighting

 collingwoodled

GUARANTEE / WARRANTY

3 year guarantee on LED driver,
1 year guarantee on battery

FEATURES & BENEFITS

Provides minimum of 3 hours of emergency lighting

Green light indicates charging of batteries

Pre-wired service offers peace of mind and reduces installation time



LEDEP06

Emergency pack for maintained lighting assembly - 3hr minimum

FEATURES

Wattage	3W
IP rating	IP20

INSTALLATION INFORMATION

Double Insulation	Yes
Inrush current	20A 0.012ms
Construction material	Plastic
Weight	420g
Case temperature (tc = °C)	70
Maximum ambient temperature	55°C
SELV	Yes
Electric class (1, 2, 3)	2

PRODUCT CODE

Product code	Description
LEDEP06	Emergency pack for maintained lighting assembly - 3hr minimum

WIRING INFORMATION

Cable / flying lead	300mm 2-core 0.75mm ²
Type of wiring required	Parallel

USE WITH

H2 Pro 550 SPS	Single point source, dimmable, fire-rated LED downlight
H2 Pro 550 CS*	Colour switchable, dimmable, fire-rated LED downlight
H2 Pro 700	Dimmable, fire-rated LED downlight
H2 Pro Dusk	Dim to warm, fire-rated LED downlight
H2 Pro Elect	Low glare, dimmable, fire-rated LED downlight
H2 Pro Elect Trimless	Low glare, plaster-in, trimless, dimmable, fire-rated LED downlight
H4 Pro 550 SPS	Adjustable, single point source, dimmable, fire-rated LED downlight
H4 Pro 700	Adjustable, dimmable fire-rated LED downlight
H4 Pro Elect	Adjustable, low glare, dimmable, fire-rated LED downlight
H5 500 Symmetric	Low glare, fire-rated LED downlight
H5 500 Asymmetric	Low glare, fire-rated LED downlight

*3000K when operating in emergency mode

474.4mm



41.3mm
22.3mm

GU10 fire-rated downlight housing.

Choose the ideal product for your installation

Fire-rated downlights provide extra flexibility and choice for those who want to be able to change the lamp themselves. Fully fire-rated and acoustic compliant, it is an ideal solution for hotels, restaurants rental accommodations and new builds.

GU10.

A GU10 lamp is a LED lamp that is easily replaceable by the end user. Only Smart GU10 lamps are available from Collingwood lighting.











Fire-rated downlight housing.

Use our GU10 fire-rated downlight housings to put a GU10 LED lamp into. Available in three different finishes, fixed or adjustable versions and IP20 or IP65 ratings to cover all installation needs.





Use the table below to choose the ideal GU10 fire-rated downlight housing for your installation.

	IP rating	Matt white	Brushed steel	Chrome
Fixed fitting	<p>IP20</p> <p>Ideal for indoor living spaces</p>	 CWFR001	 CWFR002	 CWFR003
	<p>IP65</p> <p>Ideal for bathrooms and kitchens</p>	 CWFR004	 CWFR005	 CWFR006
Adjustable fitting	<p>IP20</p> <p>Ideal for indoor living spaces</p>	 CWFR007	 CWFR008	 CWFR009

Residential downlights.

01604 495 151
collingwoodlighting.com

 @collingwoodLED

 /collingwoodlighting

 collingwoodled

GUARANTEE / WARRANTY

3 year extended warranty

FEATURES & BENEFITS

Loop-in loop-out connector for ease of installation

30, 60, 90 min fire rating providing additional safety

Acoustic and moisture tested

6-Watt LED or 50-Watt halogen lamp compatible for additional versatility

IP20

Lamp not included



GU10 Downlight

Fire-rated fixed IP20 downlight

FEATURES

IP rating	IP20
Tilttable	No
Input	Mains AC

INSTALLATION INFORMATION

Install connector type	Push-fit terminal connector
Insulation coverable	No
Cut out size	Ø 79mm
Construction material	Mild steel
Maximum ceiling thickness	40mm
Weight	0.213g
Building regulations	Part B, C, E, P
Electric class [1, 2, 3]	1

PRODUCT CODE

Product code	Finish	Description
CWFRC001	Matt white	GU10 Fire rated downlight, Fixed, IP20, White
CWFRC002	Brushed steel	GU10 Fire rated downlight, Fixed, IP20, Brushed steel
CWFRC003	Polished chrome	GU10 Fire rated downlight, Fixed, IP20, Polished chrome

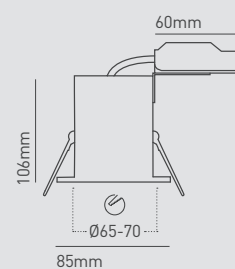

WIRING INFORMATION

Cable / flying lead	N/A
Cable required for connector	Push-fit terminal for: Twin & Earth (6242Y 2x1.5mm ²)
Type of wiring required	Parallel



Residential downlights.

01604 495 151
collingwoodlighting.com

-  @collingwoodLED
 /collingwoodlighting
 collingwoodled

GUARANTEE / WARRANTY

3 year extended warranty

FEATURES & BENEFITS

Loop-in loop-out connector for ease of installation

30, 60, 90 min fire rating providing additional safety

Acoustic and moisture tested

6-Watt LED or 50-Watt halogen lamp compatible for additional versatility

IP65

Lamp not included



GU10 Downlight

Fire-rated fixed IP65 downlight

FEATURES

IP rating	IP65
Tilttable	No
Input	Mains AC

INSTALLATION INFORMATION

Install connector type	Push-fit terminal connector
Insulation coverable	No
Cut out size	Ø 79mm
Construction material	Mild steel
Maximum ceiling thickness	40mm
Weight	0.259g
Building regulations	Part B, C, E, P
Electric class (1, 2, 3)	1

PRODUCT CODE

Product code	Finish	Description
CWFRC004	Matt white	GU10 Fire rated downlight, Fixed, IP65, White
CWFRC005	Brushed steel	GU10 Fire rated downlight, Fixed, IP65, Brushed steel
CWFRC006	Polished chrome	GU10 Fire rated downlight, Fixed, IP65, Polished chrome

WIRING INFORMATION

Cable / flying lead	N/A
Cable required for connector	Push-fit terminal for: Twin & Earth (6242Y 2x1.5mm ²)
Type of wiring required	Parallel

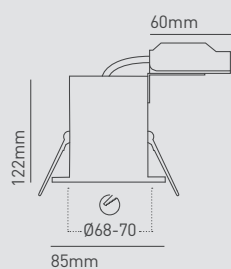

Residential downlights.

01604 495 151
collingwoodlighting.com

 @collingwoodLED

 /collingwoodlighting

 collingwoodled

GUARANTEE / WARRANTY

3 year extended warranty

FEATURES & BENEFITS

Loop-in loop-out connector for ease of installation

30, 60, 90 min fire rating providing additional safety

Acoustic and moisture tested

6-Watt LED or 50-Watt halogen lamp compatible for additional versatility

IP20

Lamp not included



GU10 Downlight

Fire-rated adjustable IP20 downlight

FEATURES

IP rating	IP20
Tilttable	20°
Input	Mains AC

INSTALLATION INFORMATION

Install connector type	Push-fit terminal connector
Insulation coverable	No
Cut out size	Ø 79mm
Construction material	Mild steel
Maximum ceiling thickness	40mm
Weight	0.258g
Building regulations	Part B, C, E, P
Electric class [1, 2, 3]	1

PRODUCT CODE

Product code	Finish	Description
CWFRC007	Matt white	GU10 Fire rated downlight, Adjustable, IP20, White
CWFRC008	Brushed steel	GU10 Fire rated downlight, Adjustable, IP20, Brushed steel
CWFRC009	Polished chrome	GU10 Fire rated downlight, Adjustable, IP20, Polished chrome

WIRING INFORMATION

Cable / flying lead	N/A
Cable required for connector	Push-fit terminal for: Twin & Earth (6242Y 2x1.5mm ²)
Type of wiring required	Parallel

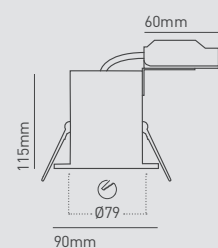

Architectural downlights.

Elegant and flexible

Created with ultimate style and function in mind, our range of contemporary architectural downlights are suited for a variety of interiors.

Bespoke modular offering with 1901, made in the UK

Our part code matrix contains nine different configurables which create a bespoke architectural downlight, perfect for any interior design. The extensive 1901 range is entirely modular with both fixed and adjustable options, and a range of bezels. The range features a choice of beam angles along with colour temperatures, IP ratings and dimming options. 1901 is engineered to be as easy to use as possible and can fit seamlessly into the installation and commissioning stages of a lighting project.

The result is over one thousand, six hundred different combinations, all readily available at short notice.

- 1 1901 baffled downlight**
- 2 Bezel / trim colour**
Choose between a matt black or matt white bezel.
- 3 Baffle trim colour**
Choose between a matt black or matt white baffle.
- 4 Style**
Choose between round, slim round, square, single trimless or double trimless style options.
- 5 Fixed / adjustable**
Choose between a fixed or adjustable fitting.
- 6 Colour temperature**
Choose between a selection of colour temperatures - 2700K, 3000K or 4000K.
- 7 Beam angle**
Choose between a wide, medium or narrow beam angle.
- 8 Dimming**
Choose from a choice of drivers to suit any control preferences - Mains, DALI-2 or 1-10V.
- 9 IP rating**
Choose the desired IP for your location - IP20, IP44 or IP65.

Fire rated hood accessory

Use a fire rated hood with your 1901 downlight, which complies with building regulations Part B.

BDLFH1



Made from woven glass fibre and with a 7 year extended warranty. Dimensions 130 x 130mm

LED colour options

Choosing the correct colour temperature for your scheme can really help to create the right environment. Available in 2700K, 3000K and 4000K, we are committed to ensuring that we have colour consistency across our range, whether that is downlights, ground lights or LED strip lighting.

2700K



3000K



4000K

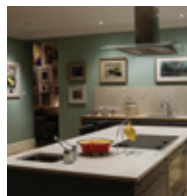

Surface mounted

Surface mounted LED downlights are perfect for when recessing is not an option. The DL Surface is equivalent to 35W halogen and comes complete with an integral driver and fixing kit, ensuring ease of install and a functional light output. Available in two colour temperatures, the DL surface and DL201 make for a great alternative to traditional downlights.

DLSURFACE



DL201



Mini adjustable spot lights

Small and discreet LED downlights provide style and function when used as part of a bigger lighting scheme or when lighting specific spaces. Made from machined aluminium, the mini adjustable lights are both sleek and functional. The mini adjustable LED spot lights can be adjusted by 20 degrees to direct the light, are designed with Plug & play connectivity and are available in two ambient LED colours.

DL120



DL130



Upgrade AR111 halogens to LED

Ideal for restaurants and other hospitality spaces, this powerful alternative for AR111 lamps utilises the latest LED technology to create efficient and interesting lighting schemes. The RL111 can be retrofitted into existing housing or our own range of AR housings for easy installation.

RL111



Upgrade MR16 halogens to LED

This compact and powerful LED module is ideal for replacing halogen lamps in existing housings. Compatible with MR16 housings and available in three LED colours, you can use with our adjustable DH housings to create discreet and low glare installations.

DM01



DM02



Fibre LED light

Historically, fibre optic lights have faced a lot of reluctance due to their cost, noise and heavy drivers which are unsuitable for installing above many ceilings. However, our fibre optic system uses just 1W of LED power to light up 30 strands and is hugely cost and time efficient. The flexibility in positioning the fibre LED light also allows for far shorter lengths of fibre optic cable.

Fibre LED Light



Fibre LED



AR housings

Complete with lamp retaining clip and fully adjustable, choose from three quality machined aluminium housings. Choose from single round, single square and double rectangular designs.

AR119



AR120



AR220



DH housings

Pick from a range of four adjustable downlight housings to create stunning effects. Choose from pinhole, baffled, highlights and wall wash designs.

DH02WH



DH03WH



DH04WH



DH05WH



Choosing the ideal 1901 downlight.

For your installation

Use the matrix below to work out which partcode you need.

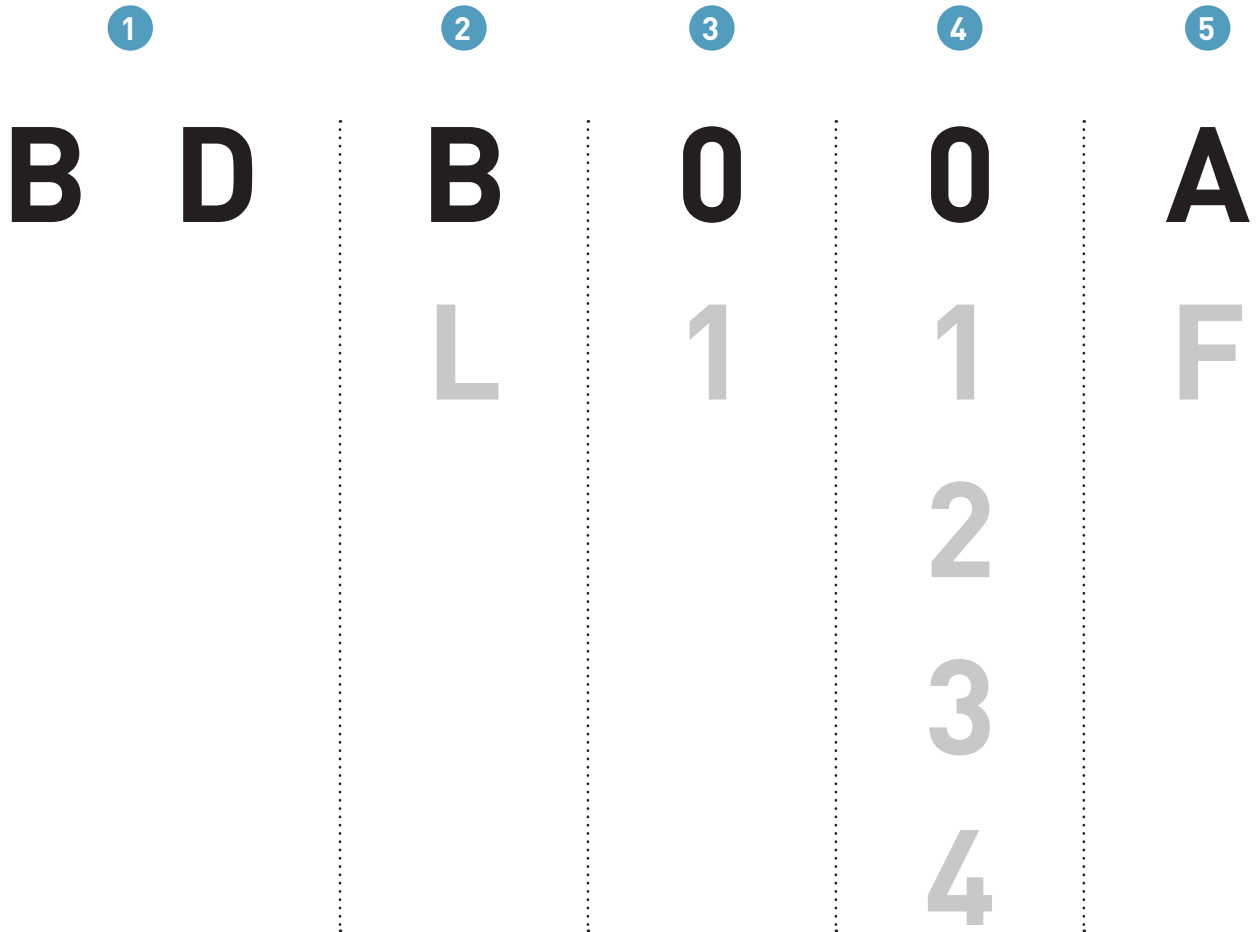

1 Product type

B D Baffled downlight

2 Bezel trim colour

B Matt black bezel / trim
L Matt white bezel / trim

3 Baffle colour

0 Matt white baffle
1 Matt black baffle

7 Beam angle

N Narrow 12°
M Medium 24°
W Wide 50°

8 Dimming

D DALI-2
M Mains
V 1-10V

9 IP rating

I IP65
- Standard version (IP20 or IP44)

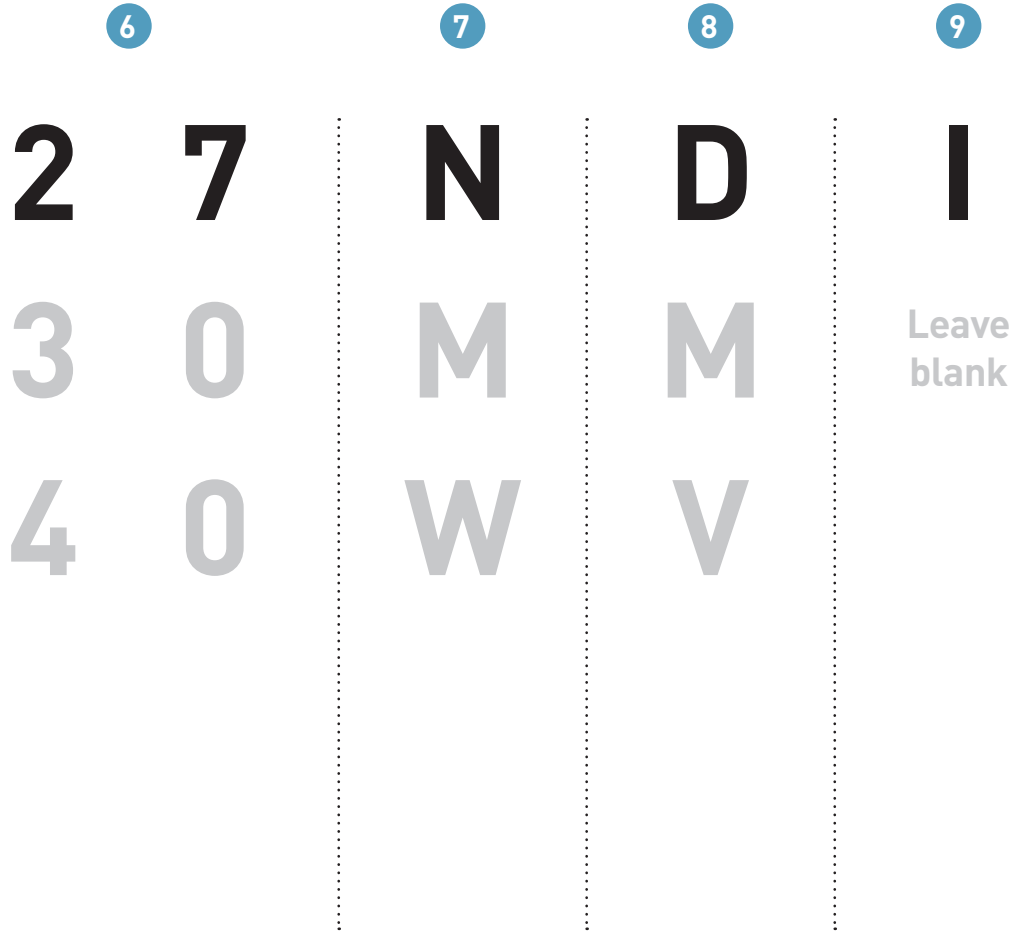

4 Style

- 0** Slim round bezel*
- 1** Round bezel
- 2** Square bezel
- 3** Single trimless
- 4** Double trimless

*Available in fixed only

5 Fixed / Adjustable

- A** Adjustable
- F** Fixed

6 Colour temperature

- 27** 2700K
- 30** 3000K
- 40** 4000K

2 Bezel / trim colour.

Slim and discreet the flat metal bezels are available in a choice of two colours.

B - Matt black bezel / trim

The black bezel is available on all round and square versions which are ideal for dark coloured ceilings to give a discreet look.

L - Matt white bezel / trim

The white bezel gives a discreet stylish low glare look for ultimate visual comfort.



4 Style.

Showcasing an aesthetically simple, low-glare luminaire design, with superior performance, a choice of styles are available to give it that perfect finish. Round, slim round, square, single trimless or double trimless style options are a perfect choice for luxury residential and hospitality lighting, giving it a sleek and stylish finish.



0 - Slim round bezel*

*Available in fixed only

2 - Square bezel

1 - Round bezel

3 Baffle colour.

Intelligently engineered with a stylish and sleek design our choice of baffles will create beautifully lit interior spaces.

0 - Matt white baffle

The white baffle will create a seamless finish blending into the ceiling.

1 - Matt black baffle

The black baffle will showcase a low-glare and high-quality appearance, showing colours and textures in their best light.



Single and double trimless versions can be plastered in for a discreet and stylish finish.



5 Fixed / adjustable.

The functional fittings are available in fixed or adjustable options.

F - Fixed

Fixed downward position achieves a broad spread of ambient light throughout a space. IP65 and IP44 versions.

A - Adjustable

Adjustable version with a 20° tilt and 360° rotatable design, ideal for vaulted ceilings so the light can be directed to exactly where it is required, such as highlighting features and artwork on walls. IP20 only.



7 Beam angle.

Wide, medium and narrow beam options can be selected, which can achieve the desired effect for the size of space.

N - Narrow 12°

The narrow beam option has a greater intensity, making it ideal for smaller spaces.

M - Medium 24°

Medium beam option has more of an intense light, which is ideal for larger spaces.

W - Wide 50°

Wide beam angle is to cover a wider area, fewer lights are required which reduces costs spent on fittings.

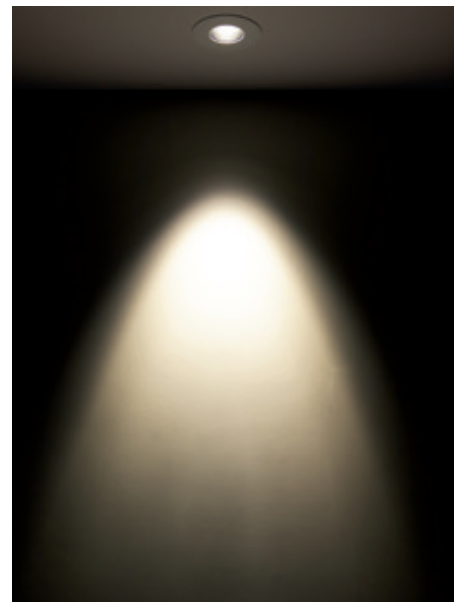
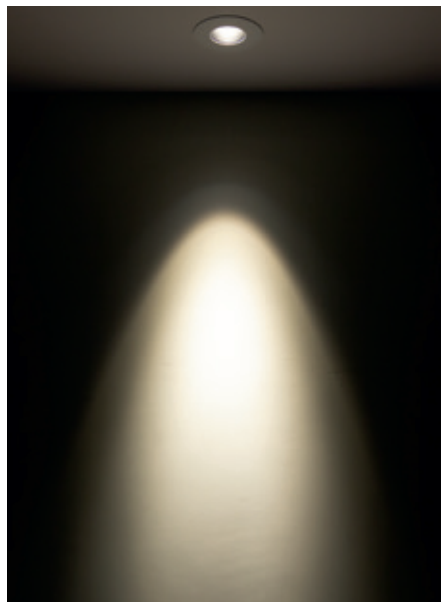

6 Colour temperature.

Creating ambience and mood of a room is hugely dependant on the lighting chosen. Our selection of colour temperatures result in a comfortable low-glare, yet high impact light that enhances luxury interiors and stunning architectural features.

2700K

Create an inviting warm ambience, ideal for living rooms and bedrooms where you want to promote relaxation.

3000K

Create a slightly soft or warm white colour temperature. This is ideal for bathrooms and home-offices where visual tasks are more common.

4000K

This produces a brighter white colour which gives a warm effect as well as bright enough to work beneath it, such as kitchens.

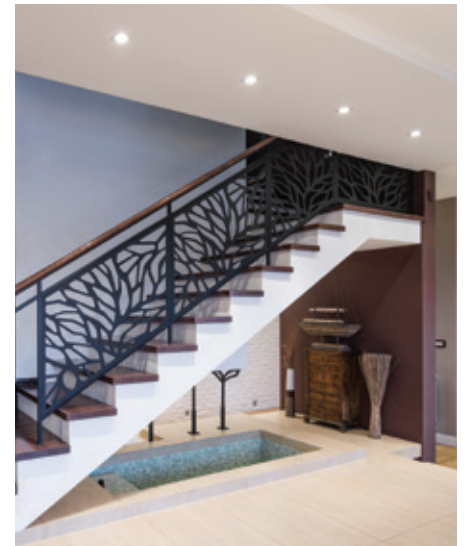

8 Dimming options.

Choose from a choice of drivers to suit any control preferences.



M - Mains driver

A mains driver is suited if the product has an integrated mains dimmable driver, no separate driver is required and comes with an Easy-fit connector.



D - DALI-2 driver

The DALI driver can be structured in a way which will allow the LED to respond to certain rooms or zones.



V - 1-10V driver

The 1-10V system allows all the LEDs which are connected to the 1-10V driver dim to an equal amount. Up to 10 power supplies can be linked to one dimmer for dimming multiple fittings.

9 IP rating.

Three IP ratings are available depending on preference.

IP20

IP20 on an adjustable fitting is ideal for indoor spaces such as living rooms, dining rooms and other living spaces.



IP44

IP44 option on a fixed fitting can be used for areas where water maybe sprayed such as kitchens.



IP65

IP65 on a fixed version can be used for indoor spaces near water such as kitchens or bathrooms.



Technical information.

Use the matrix below to generate the ideal partcode for your installation.

Black baffle



Product	CCT	Beam angle	Wattage	CRI	lm	lx at 1m
Single fitting	4000K	12°	9.6W	≥90Ra	759	9018
Single fitting	4000K	24°	9.6W	≥90Ra	740	3595
Single fitting	4000K	50°	9.6W	≥90Ra	725	1318
Single fitting	3000K	12°	9.6W	≥90Ra	650	7816
Single fitting	3000K	24°	9.6W	≥90Ra	640	3191
Single fitting	3000K	50°	9.6W	≥90Ra	625	1136
Single fitting	2700K	12°	9.6W	≥90Ra	600	7214
Single fitting	2700K	24°	9.6W	≥90Ra	580	2866
Single fitting	2700K	50°	9.6W	≥90Ra	575	985
Double fitting	4000K	12°	19.2W	≥90Ra	2 x 750	2 x 9018
Double fitting	4000K	24°	19.2W	≥90Ra	2 x 740	2 x 3595
Double fitting	4000K	50°	19.2W	≥90Ra	2 x 725	2 x 1318
Double fitting	3000K	12°	19.2W	≥90Ra	2 x 650	2 x 7816
Double fitting	3000K	24°	19.2W	≥90Ra	2 x 640	2 x 3191
Double fitting	3000K	50°	19.2W	≥90Ra	2 x 625	2 x 1136
Double fitting	2700K	12°	19.2W	≥90Ra	2 x 600	2 x 7214
Double fitting	2700K	24°	19.2W	≥90Ra	2 x 590	2 x 2866
Double fitting	2700K	50°	19.2W	≥90Ra	2 x 575	2 x 985

White baffle

Product	CCT	Beam angle	Wattage	CRI	lm	lx at 1m
Single fitting	4000K	12°	9.6W	≥90Ra	759	9018
Single fitting	4000K	24°	9.6W	≥90Ra	740	3595
Single fitting	4000K	50°	9.6W	≥90Ra	725	1318
Single fitting	3000K	12°	9.6W	≥90Ra	650	7816
Single fitting	3000K	24°	9.6W	≥90Ra	640	3191
Single fitting	3000K	50°	9.6W	≥90Ra	625	1136
Single fitting	2700K	12°	9.6W	≥90Ra	600	7214
Single fitting	2700K	24°	9.6W	≥90Ra	580	2866
Single fitting	2700K	50°	9.6W	≥90Ra	575	985
Double fitting	4000K	12°	19.2W	≥90Ra	2 x 750	2 x 9018
Double fitting	4000K	24°	19.2W	≥90Ra	2 x 740	2 x 3595
Double fitting	4000K	50°	19.2W	≥90Ra	2 x 725	2 x 1318
Double fitting	3000K	12°	19.2W	≥90Ra	2 x 650	2 x 7816
Double fitting	3000K	24°	19.2W	≥90Ra	2 x 640	2 x 3191
Double fitting	3000K	50°	19.2W	≥90Ra	2 x 625	2 x 1136
Double fitting	2700K	12°	19.2W	≥90Ra	2 x 600	2 x 7214
Double fitting	2700K	24°	19.2W	≥90Ra	2 x 590	2 x 2866
Double fitting	2700K	50°	19.2W	≥90Ra	2 x 575	2 x 985

Architectural downlights.

01604 495 151
collingwoodlighting.com

-  @collingwoodLED
-  /collingwoodlighting
-  collingwoodled

GUARANTEE / WARRANTY

7 year extended warranty

FEATURES & BENEFITS

White baffle & CRI 90+ for a low glare and high-quality appearance, showing colours and textures in their best light

Choice of fixed or adjustable function, allows you to direct light exactly where it is required

Mains, 1-10V or DALI dimming options for flexibility and integration with control systems

Comes with rolled spring clips and plug & play connectors to support ease of installation

7 year warranty: Collingwood's signature quality you can trust

Narrow beam angle for highlighting features with a high intensity of light

Medium beam angle, excellent for corridor lighting

Wide beam angle for spreading light over a larger area

Slim and discreet flat metal bezel

Beam angle: 12° 24° 50°

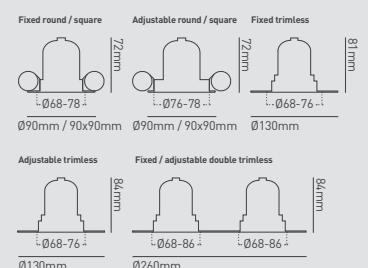
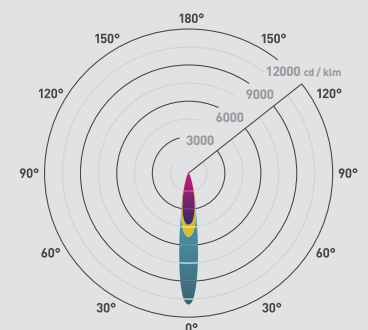

1901

Sleek, low glare, baffled downlight

FEATURES

Wattage	9.6W / 19.2W
IP rating	Adjustable IP20 Fixed IP44 / IP65
Colour flexibility	Fixed colour
Tilttable	Fixed / 20°
Rotation angle	Fixed / 360°
UGR	0
Dimmable	Mains / DALI 2 / 1-10V
Input	Mains AC
LED lifetime	70,000h L70 B10
SDCM	3SDCM
Flicker free	Yes
Emergency version available	Yes

INSTALLATION INFORMATION

Install connector type	Loop-in loop-out
Insulation coverable	No
Cut out size	Slim Round: 65-68mm Fixed: 68-78mm Adjustable: 76-78mm Single Trim: 68-76mm Double Trim: 68-86mm
Bathroom zone	Adjustable N/A Fixed 1
Inrush current	DALI: 20A 17µs Mains: 2.6A/0.3ms 1-10V: 10A/22µs
Construction material	Aluminium
Maximum ceiling thickness	40mm
Weight	240g - 260g
Maximum ambient temperature	40°C
SELV	Yes
Building regulations	IP20: Part B, P, L IP44 / IP65: Part B, C, E, P, L Part B only if Firehood accessory used
Electric class [1, 2, 3]	2

PHOTOMETRICS @ 25°C

See Page 122

WIRING INFORMATION



Cable required for connector	2 x twin & earth (6242Y 3x1.5mm ²) or 3-core cable (R02V 3x1.5mm ²)
Type of wiring required	Parallel

ACCESSORIES

LEDEP08	3hr non-maintained emergency pack (plug & play)	Sold separately	135
BDLFH1	Fire hood	Sold separately	114
DM298GRID	Grid Dimmer	Sold separately	107
DM298FP	Flatplate Dimmer	Sold separately	107

Architectural downlights.

01604 495 151
collingwoodlighting.com

 @collingwoodLED
 /collingwoodlighting
 collingwoodled

GUARANTEE / WARRANTY

7 year extended warranty

FEATURES & BENEFITS

Ceiling fitting kit included
Equivalent to 35W halogen
Fit between 3-10 units per dimmer
Cable length can be adjusted

Beam angle: 38°

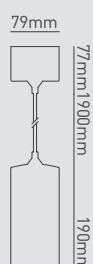
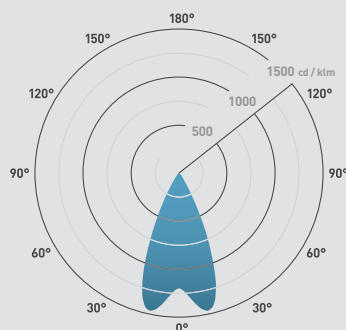

124



DL PENDANT

Dimmable, pendant downlight

FEATURES

Wattage	8W
IP rating	IP20
Colour flexibility	Fixed colour
Tilttable	No
Dimmable	No
Input	Mains AC
LED lifetime	70,000h L70 B10
SDCM	3SDCM
Emergency version available	Yes

INSTALLATION INFORMATION

Install connector type	Integrated
Cut out size	Surface mount
Bathroom zone	2
Inrush current	15A 0.5ms
Construction material	Anodised aluminium
Weight	1kg
Maximum ambient temperature	40°C
SELV	Yes
Electric class (1, 2, 3)	1

PHOTOMETRICS @ 25°C

Product code	Finish	Colour	Beam angle	CRI	lm	lm/W	lx at 1m
DL PENDANT F NW	Matt silver anodised	4000K	38°	>70Ra	455	57	657
DL PENDANT F WW	Matt silver anodised	3000K	38°	>80Ra	340	43	491

WIRING INFORMATION

Type of wiring required	Parallel
-------------------------	----------

LED DRIVERS

Product code	Input	SELV	Dimming	Bathroom zone	Min	Max
N/A (integrated SELV driver)	-	SELV	No	2	N/A	N/A

ACCESSORIES

Dimming options	Contact us on 01604 495 151 for more information
-----------------	--

Architectural downlights.

01604 495 151
collingwoodlighting.com

 @collingwoodLED

 /collingwoodlighting

 collingwoodled

GUARANTEE / WARRANTY

7 year extended warranty

FEATURES & BENEFITS

Equivalent to 35W Halogen

Ceiling fitting kit included

Fit between 3-10 products per 500W mains dimmer



DL SURFACE

Surface-mount, dimmable pendant downlight

FEATURES

Wattage	8W
IP rating	IP44
Colour flexibility	Fixed colour
Tilttable	No
Dimmable	Yes
Input	Mains AC
LED lifetime	70,000h L70 B10
SDCM	3SDCM
Emergency version available	Yes

INSTALLATION INFORMATION

Install connector type	Integrated
Cut out size	Surface mount
Bathroom zone	2
Inrush current	15A 0.5ms
Construction material	Anodised aluminium
Weight	600g
Maximum ambient temperature	40°C
SELV	Yes
Electric class [1, 2, 3]	1

PHOTOMETRICS @ 25°C

Product code	Finish	Colour	Beam angle	CRI	lm	lm/W	lx at 1m
DL SURFACE F NW	Matt silver anodised	4000K	38°	>70Ra	455	57	657
DL SURFACE F WW	Matt silver anodised	3000K	38°	>80Ra	340	43	491

WIRING INFORMATION

Type of wiring required	Parallel
-------------------------	----------

LED DRIVERS

Product code	Input	SELV	Dimming	Bathroom zone	Min	Max
N/A (integrated SELV driver)	-	SELV	Yes (mains)	2	N/A	N/A

ACCESSORIES

Dimming options	Contact us on 01604 495 151 for more information
-----------------	--

Beam angle: 38°

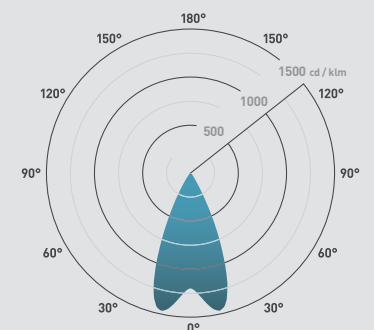

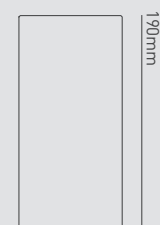

Ø79mm



Architectural downlights.

01604 495 151
collingwoodlighting.com

 @collingwoodLED

 /collingwoodlighting

 collingwoodled

GUARANTEE / WARRANTY

7 year extended warranty

FEATURES & BENEFITS

Easy to install compared to halogen

Runs cool - no need for a fan



FIBRE LED LIGHT

Fibre optic LED light injector

FEATURES

Wattage	1W
IP rating	IP20
Colour flexibility	Fixed colour
Tilttable	No
Input	350mA
LED lifetime	70,000h L70 B10
SDCM	3SDCM

INSTALLATION INFORMATION

Install connector type	Flying lead
Cut out size	N/A
Bathroom zone	1
Construction material	Aluminium
Weight	40g
Maximum ambient temperature	35°C
Electric class (1, 2, 3)	3

PHOTOMETRICS @ 25°C

Product code	Finish	Colour	CRI	lm
FIBRE LED LIGHT NW	Matt silver anodised	4000K	>80Ra	-

WIRING INFORMATION

Cable / flying lead	1m (0.205mm ² red & black PTFE)
Type of wiring required	Series

LED DRIVERS

Product code	Input	SELV	Dimming	Bathroom zone	Min	Max
PLU/350 1-9	-	Yes	No	2	1	9
PLR/350 1-5	-	Yes	No	1	1	5
PLD UNI-DRIVE 350mA	-	Yes	Yes (1-10V)	2	1	10

ACCESSORIES

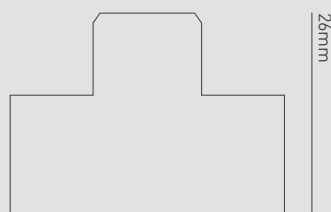

FIBRE LED 1/30	Fibre optic strands	Sold separately	127
FIBRE LED 2/30	Fibre optic strands	Sold separately	127
UY2 CONNECTOR	Quick waterproof connector	Sold separately	422
DM298GRID	LED mains grid dimmer	Sold separately	107

Ø35mm



Architectural downlights.

01604 495 151
collingwoodlighting.com

-  @collingwoodLED
-  /collingwoodlighting
-  collingwoodled

GUARANTEE / WARRANTY

1 year extended warranty

FEATURES & BENEFITS

1m (1/30) 2m (2/30) length of fibre optic
30 strands x 1mm fibres
Plug & play with FIBRE LED LIGHT



FIBRE LED

Fibre optic strands

INSTALLATION INFORMATION

Cut out size	Ø 1mm
Construction material	Plastic
Weight	FIBRE LED 1/30: 6g FIBRE LED 2/30: 12g

PRODUCT CODES

Product code	Description
FIBRE LED 1/30	Fibre optic strands
FIBRE LED 2/30	Fibre optic strands

USE WITH



No accessories required

7.5mm



Architectural downlights.

01604 495 151
collingwoodlighting.com

 @collingwoodLED
 /collingwoodlighting
 collingwoodled

GUARANTEE / WARRANTY

1 year extended warranty

FEATURES & BENEFITS

Small and discreet adjustable LED spot lights

High quality machined aluminium

Easy plug & play installation



DL120

Mini adjustable LED spot light

FEATURES

Wattage	1W
IP rating	IP20
Colour flexibility	Fixed colour
Tilttable	20°
Input	350mA
LED lifetime	70,000h L70 B10
SDCM	3SDCM
Emergency version available	Yes

INSTALLATION INFORMATION

Install connector type	Plug & play
Insulation coverable	No
Cut out size	Ø 44mm
Bathroom zone	1
Construction material	Aluminium
Maximum ceiling thickness	25mm
Weight	140g
Maximum ambient temperature	35°C
Electric class (1, 2, 3)	3

PHOTOMETRICS @ 25°C

Product code	Finish	Colour	Beam angle	CRI	lm	lm/W	lx at 1m
DL120 NW	Silver anodised	4000K	15°	>70Ra	82	82	703
DL120 WW	Silver anodised	3000K	15°	>80Ra	69	69	591

WIRING INFORMATION

Cable / flying lead	300mm (0.205mm² red & black PTFE)
Type of wiring required	Series

LED DRIVERS

Product code	Input	SELV	Dimming	Bathroom zone	Min	Max
PLU/PP/350 1-9 (Plug & play)	-	Yes	No	N/A	1	9
PLR/350 1-5	-	Yes	No	N/A	1	5
PLD UNI-DRIVE 350mA	-	Yes	Yes (1-10V)	N/A	1	10

ACCESSORIES

LED LYTE 1M EXT	1m plug & play extension lead	Sold separately	154
LED LYTE 6 WAY EXT	6 way 1m plug & play extension lead	Sold separately	154
PDC/GRID DIMMER	Grid dimmer kit for multiple fitting types	Sold separately	422
DM298GRID	LED mains grid dimmer	Sold separately	107

Beam angle: 15°

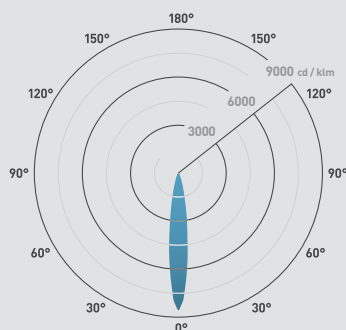

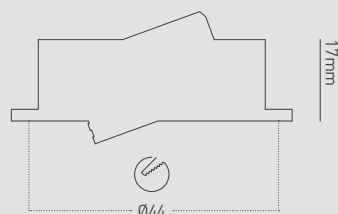

Ø51.5mm



Architectural downlights.

01604 495 151
collingwoodlighting.com

 @collingwoodLED

 /collingwoodlighting

 collingwoodled

GUARANTEE / WARRANTY

1 year extended warranty

FEATURES & BENEFITS

Small and discreet adjustable LED spot lights

High quality machined aluminium

Easy plug & play installation



DL130

Mini adjustable LED spot light

FEATURES

Wattage	1W
IP rating	IP20
Colour flexibility	Fixed colour
Tilttable	20°
Input	350mA
LED lifetime	70,000h L70 B10
SDCM	3SDCM
Emergency version available	Yes

INSTALLATION INFORMATION

Install connector type	Plug & play
Insulation coverable	No
Cut out size	Ø 53mm
Bathroom zone	1
Construction material	Aluminium
Maximum ceiling thickness	25mm
Weight	140g
Maximum ambient temperature	35°C
Electric class [1, 2, 3]	3

PHOTOMETRICS @ 25°C

Product code	Finish	Colour	Beam angle	CRI	lm	lm/W	lx at 1m
DL130 NW	Silver anodised	4000K	15°	>70Ra	82	82	703
DL130 WW	Silver anodised	3000K	15°	>80Ra	69	69	591

WIRING INFORMATION

Cable / flying lead	300mm (0.205mm² red & black PTFE)
Type of wiring required	Series

LED DRIVERS

Product code	Input	SELV	Dimming	Bathroom zone	Min	Max
PLU/PP/350 1-9 (Plug & play)	-	Yes	No	N/A	1	9
PLR/350 1-5	-	Yes	No	N/A	1	5
PLD UNI-DRIVE 350mA	-	Yes	Yes (1-10V)	N/A	1	10

ACCESSORIES

LED LYTE 1M EXT	1m plug & play extension lead	Sold separately	154
LED LYTE 6 WAY EXT	6 way 1m plug & play extension lead	Sold separately	154
PDC/GRID DIMMER	Grid dimmer kit for multiple fitting types	Sold separately	422
DM298GRID	LED mains grid dimmer	Sold separately	107

Beam angle: 15°

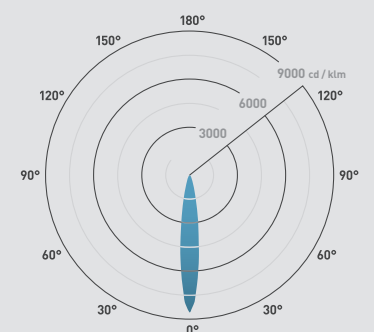

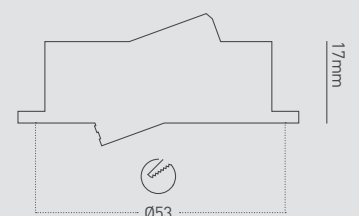

60x60mm



Architectural downlights.

01604 495 151
collingwoodlighting.com

 @collingwoodLED
 /collingwoodlighting
 collingwoodled

GUARANTEE / WARRANTY

7 year extended warranty

FEATURES & BENEFITS

High lumen output
Retrofits into existing AR111 housings
Ideal for retail and hospitality spaces
Dimmable with mains, 1-10V & DALI LED drivers
Innovative low glare design

Beam angle: 20° 40°

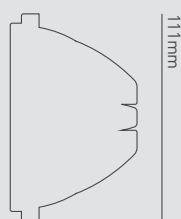
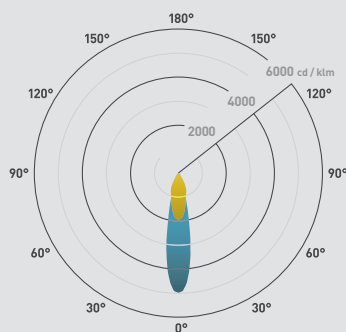

68mm

130



RL111

LED AR111 replacement for 75W halogen

FEATURES

Wattage	12W
IP rating	IP40
Colour flexibility	Fixed colour
Input	350mA
LED lifetime	60,000h L70 B10
SDCM	3SDCM
Emergency version available	Yes

INSTALLATION INFORMATION

Install connector type	Flying lead
Insulation coverable	No
Cut out size	Housing dependant
Bathroom zone	Housing dependant
Construction material	Aluminium
Weight	280g
Maximum ambient temperature	35°C
SELV	Yes
Electric class (1, 2, 3)	3

PHOTOMETRICS @ 25°C

Product code	Finish	Colour	Beam angle	CRI	lm	lm/W	lx at 1m
RL1112040	Silver anodised	4000K	20°	>80Ra	1200	100	5993
RL1114040	Silver anodised	4000K	40°	>80Ra	1200	100	2371
RL1112030	Silver anodised	3000K	20°	>80Ra	1200	100	5993
RL1114030	Silver anodised	3000K	40°	>80Ra	1200	100	2371
RL1112027	Silver anodised	2700K	20°	>80Ra	950	80	4744
RL1114027	Silver anodised	2700K	40°	>80Ra	950	80	1877

WIRING INFORMATION

Cable / flying lead	0.35m (0.205mm ² red & black PTFE)
Type of wiring required	Series

LED DRIVERS

Product code	Input	SELV	Dimming	Bathroom zone	Min	Max
PSMD3501324	220-240V	Yes	Yes (mains)	-	1	1
PLD UNI-DRIVE 350MA	220-240V	Yes	Yes (1-10V)	-	1	1
PSDAL350M	220-240V	Yes	Yes (1-10V/DALI)	-	1	2

ACCESSORIES

AR119/120/220	Adjustable housing	Sold separately	131
HAL 104	DALI interface	Sold separately	412
DM298GRID	LED mains grid dimmer	Sold separately	107
DM298FP	Faceplate dimmer	Sold separately	107

Architectural downlights.

01604 495 151
collingwoodlighting.com

 @collingwoodLED

 /collingwoodlighting

 collingwoodled

GUARANTEE / WARRANTY

1 year extended warranty

FEATURES & BENEFITS

- Complete with lamp retaining clip
- Fully adjustable
- Machined from aluminium for a quality finish

AR119

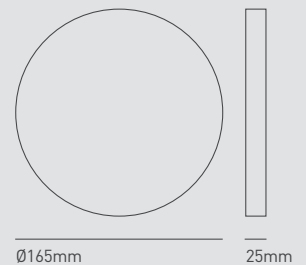

AR120

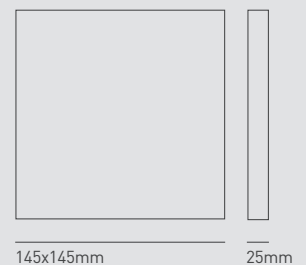

AR220

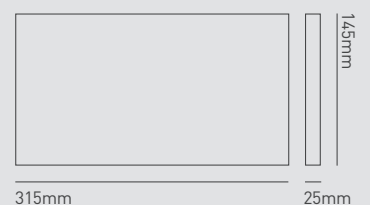

AR119 | AR120 | AR220

Round aluminium adjustable housing

FEATURES

Tilttable	20°
-----------	-----

INSTALLATION INFORMATION

Cut out size	AR119 SIL: Ø 165mm AR120 SIL: Ø 145mm AR220 SIL: 315 x 145mm
Construction material	Aluminium
Maximum ceiling thickness	25mm
Weight	AR119 SIL: 300g AR120 SIL: 360g AR220 SIL: 700g

PRODUCT CODES



Product code	Description
AR119 SIL	Round aluminium adjustable housing
AR120 SIL	Square aluminium adjustable housing
AR220 SIL	Twin fitting aluminium adjustable housing

USE WITH

RL111	LED AR111 replacement for 75W halogen
-------	---------------------------------------

Architectural downlights.

01604 495 151
collingwoodlighting.com

-  @collingwoodLED
-  /collingwoodlighting
-  collingwoodled

GUARANTEE / WARRANTY

7 year extended warranty

FEATURES & BENEFITS

- Equivalent to 50W halogen
- MR16 for retrofit into existing housings
- Plug & play connector for quick installation

Beam angle: 25°

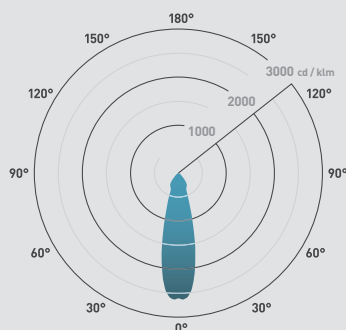

Ø50mm

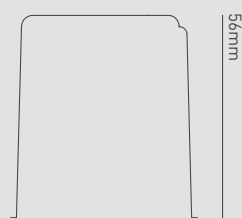

DM01

MR16 high output single source LED replacement

FEATURES

Wattage	9W
IP rating	IP40
Colour flexibility	Fixed colour
Input	700mA
LED lifetime	70,000h L70 B10
SDCM	3SDCM
Emergency version available	Yes

INSTALLATION INFORMATION

Install connector type	Plug & play
Insulation coverable	No
Cut out size	Housing dependant
Bathroom zone	Housing dependant
Construction material	Aluminium
Weight	100g
Maximum ambient temperature	40°C
SELV	Driver dependant
Electric class [1, 2, 3]	3

PHOTOMETRICS @ 25°C

Product code	Finish	Colour	Beam angle	CRI	lm	lm/W	lx at 1m
DM012540	Black	4000K	25°	>80Ra	680	76	1774
DM012527	Black	2700K	25°	>80Ra	600	67	1565

WIRING INFORMATION

Cable / flying lead	Plug & play into driver
---------------------	-------------------------

LED DRIVERS

Product code	Input	SELV	Dimming	Bathroom zone	Min	Max
PLDM70011	220-240V	Yes	Yes (mains)	2	1	1
PLD-UNIDRIVE 700	220-240V	Yes	Yes (1-10V)	1	1	2
PSDAL700M	220-240V	Yes	Yes (DALI)	2	1	5

ACCESSORIES

DH02WH	Adjustable MR16 pinhole housing	Sold separately	134
DH03WH	Adjustable MR16 baffled housing	Sold separately	134
DH04WH	Adjustable MR16 highlight housing	Sold separately	134
DH05WH	Adjustable MR16 wall wash housing	Sold separately	134
PDC/GRID DIMMER	Grid dimmer kit for multiple fitting types	Sold separately	422
DM298GRID	LED mains grid dimmer	Sold separately	107
DM298FP	Faceplate dimmer	Sold separately	107

Architectural downlights.

01604 495 151
collingwoodlighting.com

 @collingwoodLED

 /collingwoodlighting

 collingwoodled

GUARANTEE / WARRANTY

3 year extended warranty

FEATURES & BENEFITS

Equivalent to 50W halogen

MR16 for retrofit into existing housings



DM02

MR16 high output single source LED replacement

FEATURES

Wattage	6.3W
IP rating	IP40
Colour flexibility	Fixed colour
Input	180mA
LED lifetime	40,000h L70 B10
SDCM	3SDCM
Emergency version available	Yes

INSTALLATION INFORMATION

Install connector type	Plug & play
Insulation coverable	No
Cut out size	Housing dependant
Bathroom zone	Housing dependant
Construction material	Aluminium
Weight	100g
Maximum ambient temperature	40°C
SELV	Driver dependant
Electric class [1, 2, 3]	3

PHOTOMETRICS @ 25°C

Product code	Finish	Colour	Beam angle	CRI	lm	lm/W	lx at 1m
DM022430	Black	3000K	24°	>80Ra	810	129	2562

WIRING INFORMATION

Cable / flying lead	Plug & play into driver
---------------------	-------------------------

LED DRIVERS

Product code	Input	SELV	Dimming	Bathroom zone	Min	Max
PSDIM180	220-240V	Yes	Yes (mains)	2	1	1

ACCESSORIES

DH02WH	Adjustable MR16 pinhole housing	Sold separately	134
DH03WH	Adjustable MR16 baffled housing	Sold separately	134
DH04WH	Adjustable MR16 highlight housing	Sold separately	134
DH05WH	Adjustable MR16 wall wash housing	Sold separately	134
PDC/GRID DIMMER	Grid dimmer kit for multiple fitting types	Sold separately	422
DM298GRID	LED mains grid dimmer	Sold separately	107
DM298FP	Faceplate dimmer	Sold separately	107

Beam angle: 24°

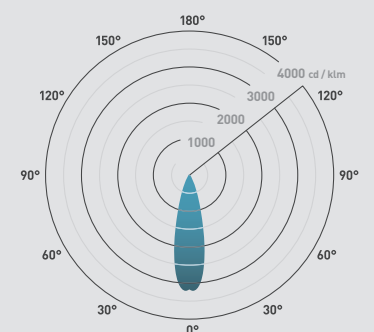

Ø50mm

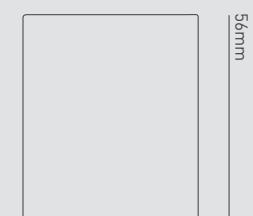



DH02WH

Adjustable, white, pinhole housing for the DM01 & DM02

FEATURES

IP rating	IP20
Tilttable	30°
Cut out size	Ø 78-83mm
Construction material	Aluminium
Maximum ceiling thickness	36mm
Weight	170g

DM01 WITH DH02WH

Colour	lm	lx at 1m
4000K	330	1051
2700K	270	860

DM02 WITH DH02WH

Colour	lm	lx at 1m
3000K	330	1760

FEATURES & BENEFITS

Replacement housing for MR16 retro-fit

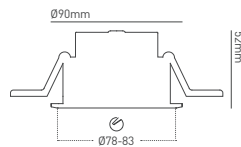

DH03WH

Adjustable, white, baffled housing for the DM01 & DM02

FEATURES

IP rating	IP20
Tilttable	30°
Cut out size	Ø 78-83mm
Construction material	Aluminium
Maximum ceiling thickness	36mm
Weight	134g

DM01 WITH DH03WH

Colour	lm	lx at 1m
4000K	480	1027
2700K	420	899

DM02 WITH DH03WH

Colour	lm	lx at 1m
3000K	480	2258

FEATURES & BENEFITS

Replacement housing for MR16 retro-fit

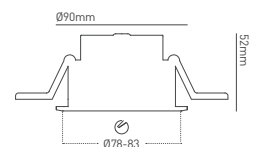

DH04WH

Adjustable, white, highlight housing for the DM01 & DM02

FEATURES

IP rating	IP20
Tilttable	30°
Cut out size	Ø 78-83mm
Construction material	Aluminium
Maximum ceiling thickness	36mm
Weight	173g

DM01 WITH DH04WH

Colour	lm	lx at 1m
4000K	330	1028
2700K	270	882

DM02 WITH DH04WH

Colour	lm	lx at 1m
3000K	320	1759

FEATURES & BENEFITS

Replacement housing for MR16 retro-fit

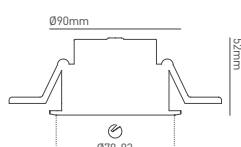

DH05WH

Adjustable, white, wall wash housing for the DM01 & DM02

FEATURES

IP rating	IP20
Tilttable	30°
Cut out size	Ø 78-83mm
Construction material	Aluminium
Maximum ceiling thickness	36mm
Weight	173g

DM01 WITH DH05WH

Colour	lm	lx at 1m
4000K	330	1028
2700K	270	841

DM02 WITH DH05WH

Colour	lm	lx at 1m
3000K	320	1577

FEATURES & BENEFITS

Replacement housing for MR16 retro-fit

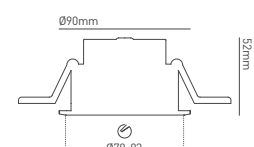

Architectural downlights.

01604 495 151
collingwoodlighting.com

 @collingwoodLED

 /collingwoodlighting

 collingwoodled

GUARANTEE / WARRANTY

3 year guarantee on LED driver,
1 year guarantee on battery

FEATURES & BENEFITS

Plug & play connectors for easy installation

Separate LED indicator light

For use with 1901 range



LEDEP08

3-hour non-maintained emergency pack

FEATURES

Wattage	3W
IP rating	IP20
Input	220-240V

INSTALLATION INFORMATION

Install connector type	Flying lead
Insulation coverable	No
Double Insulation	Yes
Inrush current	20A 0.012ms
Construction material	Plastic
Case Temperature (tc = °C)	70°C
Maximum ambient temperature	35°C
SELV	Yes
Electric class (1, 2, 3)	2

PRODUCT CODES

Product code	Description
LEDEP08	3hr LED maintained emergency pack

WIRING INFORMATION

Cable / flying lead	Plug & play connectors
---------------------	------------------------

USE WITH

1901	Sleek, low glare, baffled downlight
------	-------------------------------------

LEDEP08 folded

241mm

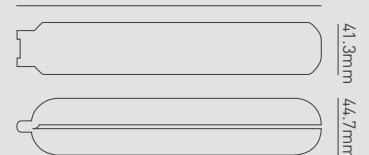

LEDEP08 unfolded

474.4mm

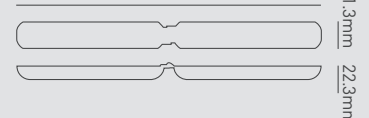

Decorative wall lights & under shelf lighting.

Discreet and interesting

Our extensive range of decorative and under shelf lighting has a multitude of attractive options which are suitable for any installation.

Choose your effect and how to create it

Highlight architectural features or illuminate specific objects with discreet lighting. The images below demonstrate how to create various effects.

Choose your effect



Low-level decorative lighting

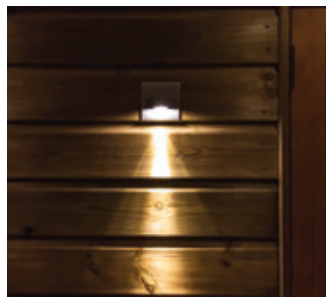

Mid-level wall lighting



Low-level wall lighting



Backdrop / feature lighting



Invigorates ordinary spaces or dark corners with a mini decorative light. The ML family are a superb solution for this due to their small, recessed profiles. It is particularly effective when used for kick-boards or illuminating steps.



Use wall lights to illuminate your space without creating overhead shadow. Highlighting walls is a great way to create ambience and atmosphere through the soft light, whilst also utilising reflection to make small spaces feel larger.



Delivering light directly onto the floor, this technique is great for creating low glare, ambient lighting in any room, whilst also aiding occupants to navigate their way around when overhead lighting is switched off.



Integrating discreet lighting into furniture, under cupboards or in small spaces provides the user with an elegant, contemporary and perfectly lit space. The LED LYTE is perfect for this type of installation.

LED LYTE family

This flush-mounted mini LED family adds a touch of detail that has the ability to transform a room. With a wide beam angle of 110°, they create a subtle yet atmospheric accent of light. With a threaded version perfect for fitting within a cabinet or in an alcove, it couldn't be easier to showcase objects or features. Also available in an IP65 version for added versatility. The plug and play connector makes this product versatile and easy to install.



Decorative mini spot lights

Great for highlighting pictures and focal items or for reading and adding style to the walls, obtain a functional and stylish finish using our mini wall lights. These products are made using marine grade stainless steel and are IP rated to 65, allowing for installation both indoors and outdoors. Choose from three colour temperatures and three wall mounting brackets to suit any lighting scheme.



MS02 IP

This spot lens creates an atmospheric environment, especially when lit onto tall ceilings and columns.



MF02 IP

Use this adjustable LED mini light with flood lens to wash light across walls or ceilings.

Mounting brackets

Adding flexibility and functionality to the mini wall lights couldn't be easier with three mounting bracket options available suit any scheme. Choose from a single, stainless steel bracket or two double mounting options, allowing for ultimate flexibility. All brackets come complete with wall fixings.

WB/M 01



WB/M 02/30°



WB/M 02



Decorative mini wall lights

The selection of decorative marker light products are highly discreet, highly decorative and highly effective, available in a range of white and coloured light. Choose from flush or raised mounted, radial or halo lit effect for stylish and contemporary lighting in both interior and exterior spaces.

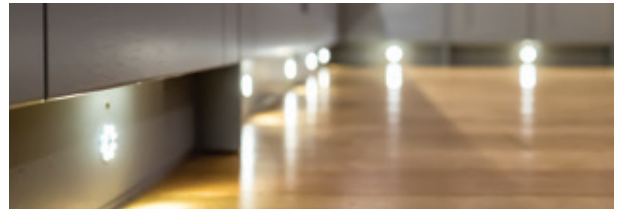

ML01

Designed to add style to floors, walls and ceilings, these lights can be walked over and are IP68 rated, allowing for installation in any environment. Due to the clever design of the product, no glare will be felt, even when looking directly at the light.



ML02

Contemporary and chic yet understatedly rugged, ML02 mini light adds style to floors, walls and ceilings. Made using marine grade stainless steel and IP rated to 68, this product is acceptable for use in or outdoors.

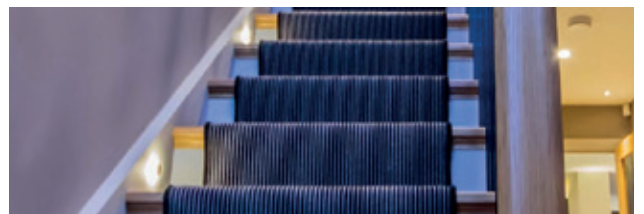



ML03

Emitting a 'halo' effect, this elegant design adds instant impact to any area. Finished in high quality anodised aluminium, this classic design will fit perfectly in superior establishments and residential environments.

Decorative wall lights.

01604 495 151
collingwoodlighting.com

 @collingwoodLED
 /collingwoodlighting
 collingwoodled

GUARANTEE / WARRANTY

7 year extended warranty

FEATURES & BENEFITS

Bi-directional mini cube for discreet accent lighting of interior and exterior spaces

Bespoke wall plug for easy installation

Quality brushed aluminium finish

Requires 20mm drill bit



MC020 S

Up / down mini cuboid LED wall light

FEATURES

Wattage	2W
IP rating	IP65
Colour flexibility	Fixed colour
Tilttable	No
Rotatable	No
Dimmable	No
Input	350mA
LED lifetime	70,000h L70 B10
SDCM	3SDCM

INSTALLATION INFORMATION

Cut out size	Ø 20mm
Bathroom zone	1
Inrush current	N/A
Construction material	Anodised aluminium
Weight	200g
Maximum ambient temperature	35°C
Electric class (1, 2, 3)	3

PHOTOMETRICS @ 25°C

Product code	Colour	Beam angle	CRI	lm	lm/W	lx at 1m
MC020 S NW	4000K	12°	>70Ra	140	70	1485
MC020 S WW	3000K	12°	>80Ra	110	55	1466
MC020 S 27	2700K	12°	>80Ra	107	54	1425
MC020 S AMBER	Amber	12°	-	-	-	-
MC020 S BLUE	Blue	12°	-	-	-	-
MC020 S GREEN	Green	12°	-	-	-	-
MC020 S RED	Red	12°	-	-	-	-

WIRING INFORMATION

Cable / flying lead	0.15m (0.205mm ² red & black PTFE)
Type of wiring required	Series

LED DRIVERS

Product code	Input	SELV	Dimming	Bathroom zone	Min	Max
PLU/350 1-9	-	Yes	No	1	1	4
PLR/350 1-5	-	Yes	No	1	1	2
PLD UNI-DRIVE 350MA	-	Yes	Yes (1-10V)	2	1	5

ACCESSORIES

CR135	PTFE cable	Sold separately	423
PDC/GRID DIMMER	Grid dimmer kit for multiple fitting types	Sold separately	422
UY2 CONNECTOR	Quick waterproof connector	Sold separately	422

Beam angle: 12°

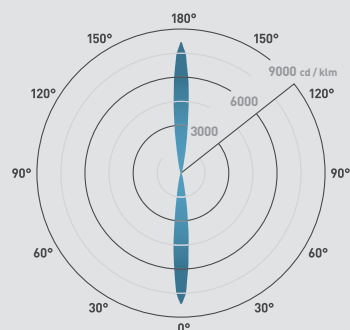

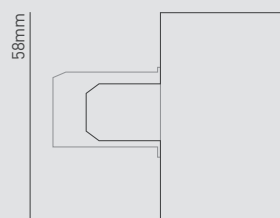

33x33/29.5mm



Decorative wall lights.

01604 495 151
collingwoodlighting.com

 @collingwoodLED

 /collingwoodlighting

 collingwoodled

GUARANTEE / WARRANTY

7 year extended warranty

FEATURES & BENEFITS

Mini cube spot light for discreet accent lighting of interior and exterior spaces

Bespoke wall plug for easy installation

Quality brushed aluminium finish

Requires 20mm drill bit



MC010 S

Mini cube LED wall light

FEATURES

Wattage	1W
IP rating	IP65
Colour flexibility	Fixed colour
Tilttable	No
Rotatable	No
Dimmable	No
Input	350mA
LED lifetime	70,000h L70 B10
SDCM	3SDCM

INSTALLATION INFORMATION

Cut out size	Ø 20mm
Bathroom zone	1
Inrush current	N/A
Construction material	Anodised aluminium
Weight	100g
Maximum ambient temperature	35°C
Electric class [1, 2, 3]	3

PHOTOMETRICS @ 25°C

Product code	Colour	Beam angle	CRI	lm	lm/W	lx at 1m
MC010 S NW	4000K	12°	>70Ra	70	70	1485
MC010 S WW	3000K	12°	>80Ra	55	55	1466
MC010 S 27	2700K	12°	>80Ra	53	53	1425
MC010 S AMBER	Amber	12°	-	-	-	-
MC010 S BLUE	Blue	12°	-	-	-	-
MC010 S GREEN	Green	12°	-	-	-	-
MC010 S RED	Red	12°	-	-	-	-

WIRING INFORMATION

Cable / flying lead	0.15m (0.205mm ² red & black PTFE)
Type of wiring required	Series

LED DRIVERS

Product code	Input	SELV	Dimming	Bathroom zone	Min	Max
PLU/350 1-9	-	Yes	No	1	1	9
PLR/350 1-5	-	Yes	No	1	1	5
PLD UNI-DRIVE 350MA	-	Yes	Yes (1-10V)	2	1	10

ACCESSORIES

CR135	PTFE cable	Sold separately	423
PDC/GRID DIMMER	Grid dimmer kit for multiple fitting types	Sold separately	422
UY2 CONNECTOR	Quick waterproof connector	Sold separately	422

Beam angle: 12°

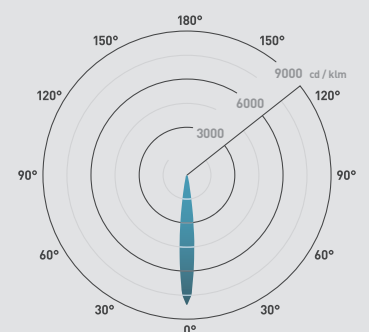

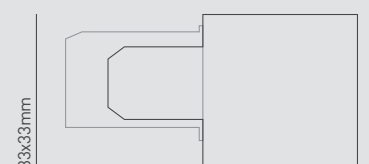

33x33/29.5mm



Decorative wall lights.

01604 495 151
collingwoodlighting.com

 @collingwoodLED
 /collingwoodlighting
 collingwoodled

GUARANTEE / WARRANTY

7 year extended warranty

FEATURES & BENEFITS

Straight to mains mini cube spot lights for discreet accent lighting of interior spaces

Quality brushed aluminium finish

Complete with wall fixings and waterproof crimp connectors

Patress box included



MC015 S

Straight to mains mini LED cube wall light

FEATURES

Wattage	1.5W
IP rating	IP20
Colour flexibility	Fixed colour
Tiltable	No
Rotatable	No
Dimmable	No
Input	Mains AC
LED lifetime	70,000h L70 B10
SDCM	3SDCM

INSTALLATION INFORMATION

Cut out size	N/A
Bathroom zone	N/A
Inrush current	60A 0.037ms
Construction material	Anodised aluminium
Weight	175g
Maximum ambient temperature	35°C
Electric class (1, 2, 3)	1

PHOTOMETRICS @ 25°C

Product code	Colour	Beam angle	CRI	lm	lm/W	lx at 1m
MC015 S NW	4000K	12°	>80Ra	70	47	1485
MC015 S WW	3000K	12°	>80Ra	55	37	1466
MC015 S 27	2700K	12°	>80Ra	53	35	1425

WIRING INFORMATION

Cable / flying lead	N/A
Type of wiring required	Parallel

LED DRIVERS

Product code	Input	SELV	Dimming	Bathroom zone	Min	Max
N/A (integrated SELV driver)	-	-	No	-	-	-

Beam angle: 12°

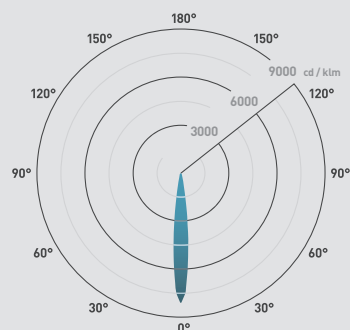

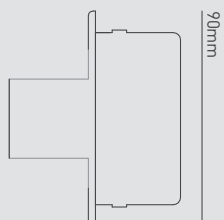

36/35mm



Decorative wall lights.

01604 495 151
collingwoodlighting.com

 @collingwoodLED

 /collingwoodlighting

 collingwoodled

GUARANTEE / WARRANTY

7 year extended warranty

FEATURES & BENEFITS

Straight to mains mini cube spot lights for discreet accent lighting of interior spaces

Quality brushed aluminium finish

Complete with wall fixings and waterproof crimp connectors

Patress box included



MC025 S

Straight to mains, up / down mini LED cube wall light

FEATURES

Wattage	2.3W
IP rating	IP20
Colour flexibility	Fixed colour
Tilttable	No
Rotatable	No
Dimmable	No
Input	Mains AC
LED lifetime	70,000h L70 B10
SDCM	3SDCM

INSTALLATION INFORMATION

Cut out size	N/A
Bathroom zone	N/A
Inrush current	60A 0.037ms
Construction material	Anodised aluminium
Weight	380g
Maximum ambient temperature	35°C
Electric class [1, 2, 3]	1

PHOTOMETRICS @ 25°C

Product code	Colour	Beam angle	CRI	lm	lm/W	lx at 1m
MC025 S NW	4000K	12°	>80Ra	140	61	1485
MC025 S 27	2700K	12°	>80Ra	107	47	1425

WIRING INFORMATION

Cable / flying lead	N/A
Type of wiring required	Parallel

LED DRIVERS

Product code	Input	SELV	Dimming	Bathroom zone	Min	Max
N/A (integrated SELV driver)	-	-	No	-	-	-

Beam angle: 12°

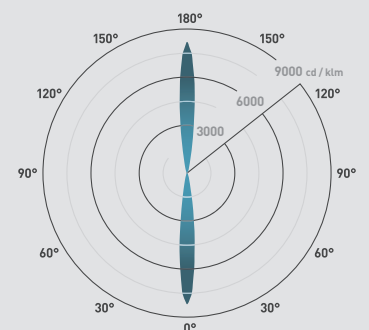

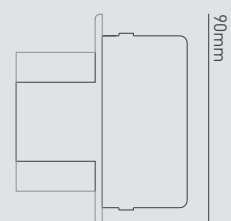

36/35mm



Decorative wall lights.

01604 495 151
collingwoodlighting.com

 @collingwoodLED

 /collingwoodlighting

 collingwoodled

GUARANTEE / WARRANTY

7 year extended warranty

FEATURES & BENEFITS

Mini spot light for discreet illumination

Can be used for interior and exterior applications

Can be rotated and angled to direct light



MF02 IP

Adjustable LED mini light

FEATURES

Wattage	1W
IP rating	IP65
Colour flexibility	Fixed colour
Tilttable	45°
Rotatable	360°
Dimmable	No
Input	350mA
LED lifetime	70,000h L70 B10
SDCM	3SDCM

INSTALLATION INFORMATION

Cut out size	N/A
Bathroom zone	1
Inrush current	N/A
Construction material	Stainless steel (316)
Weight	90g
Maximum ambient temperature	35°C
Electric class (1, 2, 3)	3

PHOTOMETRICS @ 25°C

Product code	Colour	Beam angle	CRI	lm	lm/W	lx at 1m
MF02 IP NW	4000K	16°	>70Ra	66	66	452
MF02 IP WW	3000K	16°	>80Ra	53	53	252
MF02 IP 27	2700K	16°	>80Ra	52	52	245
MF02 IP AMBER	Amber	16°	-	-	-	-
MF02 IP BLUE	Blue	16°	-	-	-	-
MF02 IP GREEN	Green	16°	-	-	-	-
MF02 IP RED	Red	16°	-	-	-	-

WIRING INFORMATION

Cable / flying lead	0.15m (0.205mm ² red & black PTFE)
Type of wiring required	Series

LED DRIVERS

Product code	Input	SELV	Dimming	Bathroom zone	Min	Max
PLU/350 1-9	-	Yes	No	1	1	9
PLR/350 1-5	-	Yes	No	1	1	5
PLD UNI-DRIVE 350MA	-	Yes	Yes (1-10V)	2	1	10

ACCESSORIES

WB/M 01 / WB/M 02	Single bracket / double bracket	Sold separately	144
CR135	PTFE cable	Sold separately	423
PDC/GRID DIMMER	Grid dimmer kit for multiple fitting types	Sold separately	422
UY2 CONNECTOR	Quick waterproof connector	Sold separately	422

Beam angle: 16°

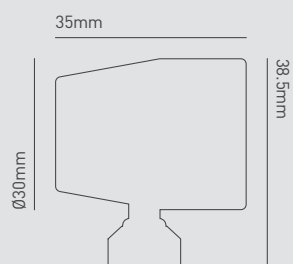
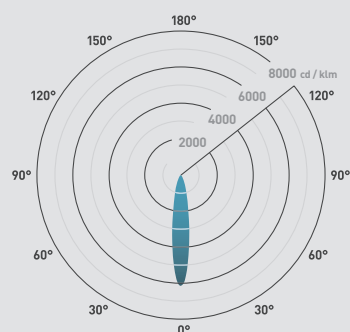

Decorative wall lights.

01604 495 151
collingwoodlighting.com

 @collingwoodLED

 /collingwoodlighting

 collingwoodled

GUARANTEE / WARRANTY

7 year extended warranty

FEATURES & BENEFITS

Mounting plates available

Can be rotated and angled to direct light



MS02 IP

Adjustable LED mini light

FEATURES

Wattage	1W
IP rating	IP65
Colour flexibility	Fixed colour
Tilttable	45°
Rotatable	360°
Dimmable	No
Input	350mA
LED lifetime	70,000h L70 B10
SDCM	3SDCM

INSTALLATION INFORMATION

Cut out size	N/A
Bathroom zone	1
Inrush current	N/A
Construction material	Stainless steel (316)
Weight	90g
Maximum ambient temperature	35°C
Electric class [1, 2, 3]	3

PHOTOMETRICS @ 25°C

Product code	Colour	Beam angle	CRI	lm	lm/W	lx at 1m
MS02 IP NW	4000K	12°	>70Ra	73	73	2160
MS02 IP WW	3000K	12°	>80Ra	50	50	2000
MS02 IP 27	2700K	12°	>80Ra	49	49	1944
MS02 IP AMBER	Amber	12°	-	-	-	-
MS02 IP BLUE	Blue	12°	-	-	-	-
MS02 IP GREEN	Green	12°	-	-	-	-
MS02 IP RED	Red	12°	-	-	-	-

WIRING INFORMATION

Cable / flying lead	0.15m (0.205mm ² red & black PTFE)
Type of wiring required	Series

LED DRIVERS

Product code	Input	SELV	Dimming	Bathroom zone	Min	Max
PLU/350 1-9	-	Yes	No	1	1	9
PLR/350 1-5	-	Yes	No	1	1	5
PLD UNI-DRIVE 350MA	-	Yes	Yes (1-10V)	2	1	10

ACCESSORIES

WB/M 01 / WB/M 02	Single bracket / double bracket	Sold separately	144
CR135	PTFE cable	Sold separately	423
PDC/GRID DIMMER	Grid dimmer kit for multiple fitting types	Sold separately	422
UY2 CONNECTOR	Quick waterproof connector	Sold separately	422

Beam angle: 12°

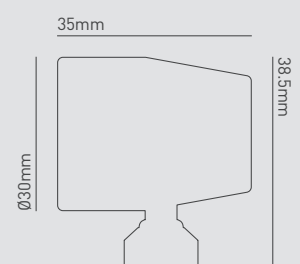
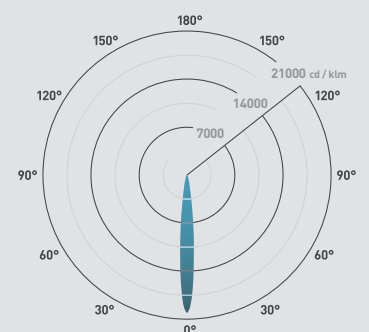



WB/M 01

Bracket for MF02 IP & MS02 IP

FEATURES

Product code	WB/M 01
Construction material	Stainless steel (316)
Weight	60g
Guarantee	1 year guarantee

USE WITH

MF02 IP	142
MS02 IP	143



WB/M 02

WB/M 02 Bracket for MF02 IP & MS02 IP

FEATURES

Product code	WB/M 02
Construction material	Stainless steel (316)
Weight	100g
Guarantee	1 year guarantee

USE WITH

MF02 IP	142
MS02 IP	143

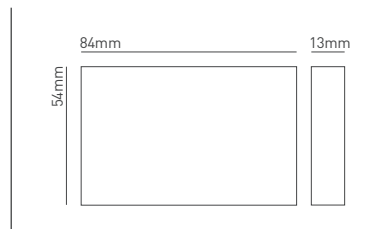

WB/M 02/30 DEGREE

Angled double bracket for MF02 IP & MS02 IP

FEATURES

Product code	WB/M 02/30 DEGREE
Construction material	Stainless steel (316)
Weight	100g
Guarantee	1 year guarantee

USE WITH

MF02 IP	142
MS02 IP	143
WB/M BOX	144

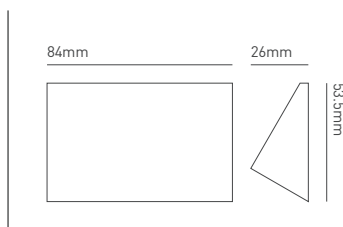

WB/M BOX

Back box for WB/M 02/30°

FEATURES

Product code	WB/M BOX
Construction material	Steel
Weight	71.8g
Guarantee	1 year guarantee

USE WITH

WB/M 02/30°	144
-------------	-----

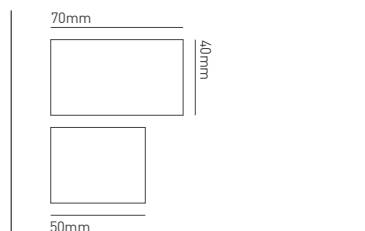

Decorative wall lights.

01604 495 151
collingwoodlighting.com

 @collingwoodLED

 /collingwoodlighting

 collingwoodled

GUARANTEE / WARRANTY

1 year extended warranty

FEATURES & BENEFITS

Plug & play connector for quick installation

Wall box available



WL050

LED wall / step light

FEATURES

Wattage	1W
IP rating	IP20
Colour flexibility	Fixed colour
Tilttable	No
Rotatable	No
Input	350mA
Dimmable	No
LED lifetime	50,000h
SDCM	3SDCM

INSTALLATION INFORMATION

Cut out size	77x77mm
Bathroom zone	N/A
Inrush current	N/A
Construction material	Aluminium
Weight	160g
Maximum ambient temperature	35°C
Electric class (1, 2, 3)	3

PHOTOMETRICS @ 25°C

Product code	Colour	Beam angle	CRI	lm	lm/W	lx at 1m
WL050 NW	4000K	84°	>80Ra	62	52	23
WL050 WW	3000K	84°	>80Ra	29	24	13
WL050 27	2700K	84°	>80Ra	28	23	13
WL050 BLUE	Blue	84°	-	-	-	-

WIRING INFORMATION

Cable / flying lead	0.3m (0.205mm ² red & black PTFE)
Type of wiring required	Series

LED DRIVERS

Product code	Input	SELV	Dimming	Bathroom zone	Min	Max
PLU/PP/350 1-9 (Plug & play)	-	Yes	No	-	1	9
PLR/350 1-5	-	Yes	No	-	1	5
PLD UNI-DRIVE 350MA	-	Yes	Yes (1-10V)	-	1	10

ACCESSORIES

WL050 WALL BOX	Wall box for WL050	Sold separately	146
LED LYTE 1M EXT	1m plug & play extension lead	Sold separately	154
LED LYTE 6 WAY EXT	6-way 1m plug & play extension lead	Sold separately	154
PDC/GRID DIMMER	Grid dimmer kit for multiple fitting types	Sold separately	422

Beam angle: 84° C0/C180 84° C90/C270

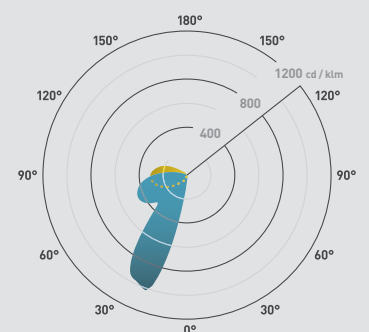

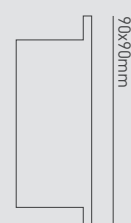

37mm



Decorative wall lights.

01604 495 151
collingwoodlighting.com

 @collingwoodLED
 /collingwoodlighting
 collingwoodled

GUARANTEE / WARRANTY

1 year extended warranty

FEATURES & BENEFITS

Wall box does not contain an earth terminal, therefore you should not place LED driver into bottom of unit



WL050 WALL BOX

Wall box for WL050

FEATURES

IP rating	IP20
-----------	------

INSTALLATION INFORMATION

Cut out size	77x77mm
Construction material	Steel
Weight	200g

PRODUCT CODES

Product code	Description
WL050 WALL BOX	Wall box for WL050

USE WITH

WL050	LED wall / step light
-------	-----------------------

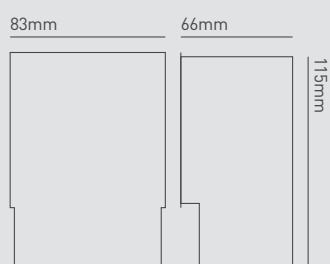

Decorative wall lights.

01604 495 151
collingwoodlighting.com

 @collingwoodLED

 /collingwoodlighting

 collingwoodled

GUARANTEE / WARRANTY

7 year extended warranty

FEATURES & BENEFITS

Small & discreet decorative recessed LED light

Perfect for discreet decorative light in interior and exterior applications

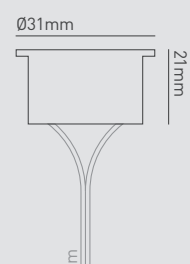
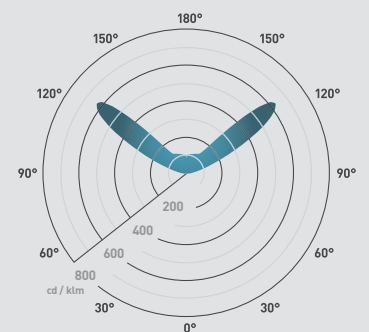

ML01

Decorative LED mini light

FEATURES

Wattage	1W
IP rating	IP68
Colour flexibility	Fixed colour
Tilttable	No
Rotatable	No
Dimmable	No
Input	350mA
LED lifetime	70,000h L70 B10
SDCM	3SDCM

INSTALLATION INFORMATION

Cut out size	Ø 26mm
Bathroom zone	0
Inrush current	N/A
Construction material	Stainless steel (316)
Weight	50g
Maximum ambient temperature	35°C
Electric class [1, 2, 3]	3

PHOTOMETRICS @ 25°C

Product code	Colour	CRI	lm	lm/W	lx at 1m
ML01 NW	4000K	>70Ra	4	4	0
ML01 WW	3000K	>80Ra	3.6	3	0
ML01 27	2700K	>80Ra	3.5	3.5	0
ML01 AMBER	Amber	-	-	-	-
ML01 BLUE	Blue	-	-	-	-
ML01 GREEN	Green	-	-	-	-
ML01 RED	Red	-	-	-	-

WIRING INFORMATION

Cable / flying lead	1m (0.205mm ² red & black PTFE)
Type of wiring required	Series

LED DRIVERS



Product code	Input	SELV	Dimming	Bathroom zone	Min	Max
PLU/350 1-9	-	Yes	No	1	1	9
PLR/350 1-5	-	Yes	No	1	1	5
PLD UNI-DRIVE 350MA	-	Yes	Yes (1-10V)	2	1	10

ACCESSORIES

CR135	PTFE cable	Sold separately	423
PDC/GRID DIMMER	Grid dimmer kit for multiple fitting types	Sold separately	422
UY2 CONNECTOR	Quick waterproof connector	Sold separately	422

Decorative wall lights.

01604 495 151
collingwoodlighting.com

 @collingwoodLED
 /collingwoodlighting
 collingwoodled

GUARANTEE / WARRANTY

7 year extended warranty

FEATURES & BENEFITS

Great for guidance lighting

Can be used in interior and exterior applications

Small & discreet decorative LED light

Raised profile creates diffused glow effect on surrounding surface



ML02

Decorative LED mini light

FEATURES

Wattage	1W
IP rating	IP68
Colour flexibility	Fixed colour
Tilttable	No
Rotatable	No
Dimmable	No
Input	350mA
LED lifetime	70,000h L70 B10
SDCM	3SDCM

INSTALLATION INFORMATION

Cut out size	Ø 26mm
Bathroom zone	0
Inrush current	N/A
Construction material	Stainless steel (316)
Weight	50g
Maximum ambient temperature	35°C
Electric class (1, 2, 3)	3

PHOTOMETRICS @ 25°C

Product code	Colour	CRI	lm	lm/W	lx at 1m
ML02 NW	4000K	>70Ra	35	35	4
ML02 WW	3000K	>80Ra	24	24	3
ML02 27	2700K	>80Ra	23	23	3
ML02 AMBER	Amber	-	-	-	-
ML02 BLUE	Blue	-	-	-	-
ML02 GREEN	Green	-	-	-	-
ML02 RED	Red	-	-	-	-

WIRING INFORMATION

Cable / flying lead	1m (0.205mm ² red & black PTFE)
Type of wiring required	Series

LED DRIVERS

Product code	Input	SELV	Dimming	Bathroom zone	Min	Max
PLU/350 1-9	-	Yes	No	1	1	9
PLR/350 1-5	-	Yes	No	0	1	5
PLD UNI-DRIVE 350MA	-	Yes	Yes (1-10V)	2	1	10

ACCESSORIES

CR135	PTFE cable	Sold separately	423
PDC/GRID DIMMER	Grid dimmer kit for multiple fitting types	Sold separately	422
UY2 CONNECTOR	Quick waterproof connector	Sold separately	422

Beam angle:

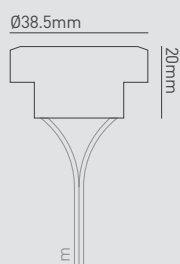
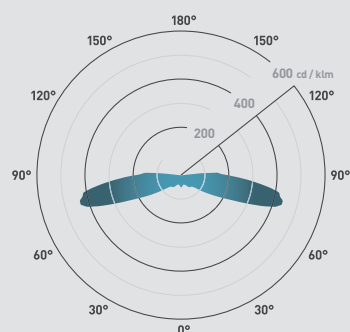

Decorative wall lights.

01604 495 151
collingwoodlighting.com

 @collingwoodLED

 /collingwoodlighting

 collingwoodled

GUARANTEE / WARRANTY

7 year extended warranty

FEATURES & BENEFITS

Raised profile creates diffused glow effect on surrounding surface

Can be used for interior and exterior applications

Small, discreet and low glare decorative LED light



ML03

Mini halo LED wall light

FEATURES

Wattage	1W
IP rating	IP65
Colour flexibility	Fixed colour
Tilttable	No
Rotatable	No
Dimmable	No
Input	350mA
LED lifetime	70,000h L70 B10
SDCM	3SDCM

INSTALLATION INFORMATION

Cut out size	Ø 26mm
Bathroom zone	1
Inrush current	N/A
Construction material	Anodised aluminium
Weight	60g
Maximum ambient temperature	30°C
Electric class [1, 2, 3]	3

PHOTOMETRICS @ 25°C

Product code	Colour	CRI	lm	lm/W	lx at 1m
ML03 NW	4000K	>70Ra	40	40	4
ML03 WW	3000K	>80Ra	28	28	3
ML03 27	2700K	>80Ra	27	27	3
ML03 AMBER	Amber	-	-	-	-
ML03 BLUE	Blue	-	-	-	-
ML03 GREEN	Green	-	-	-	-
ML03 RED	Red	-	-	-	-

WIRING INFORMATION

Cable / flying lead	1m (0.205mm ² red & black PTFE)
Type of wiring required	Series

LED DRIVERS

Product code	Input	SELV	Dimming	Bathroom zone	Min	Max
PLU/350 1-9	-	Yes	No	1	1	9
PLR/350 1-5	-	Yes	No	1	1	5
PLD UNI-DRIVE 350MA	-	Yes	Yes (1-10V)	2	1	10

ACCESSORIES

CR135	PTFE cable	Sold separately	423
PDC/GRID DIMMER	Grid dimmer kit for multiple fitting types	Sold separately	422
UY2 CONNECTOR	Quick waterproof connector	Sold separately	422

Beam angle:

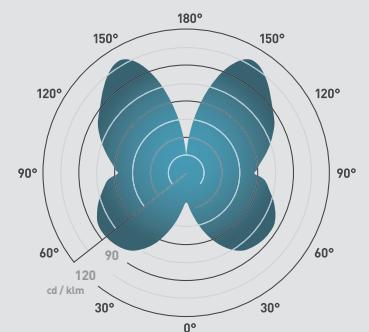

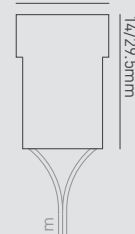

Ø30mm



Decorative wall lights.

01604 495 151
collingwoodlighting.com

-  @collingwoodLED
-  /collingwoodlighting
-  collingwoodled

GUARANTEE / WARRANTY

7 year extended warranty

FEATURES & BENEFITS

- Plug & play connector for quick installation
- Complete with wall fixings
- Small & discreet, ideal for under cabinet lighting

Beam angle: 110°

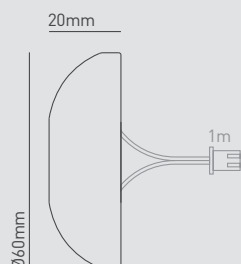
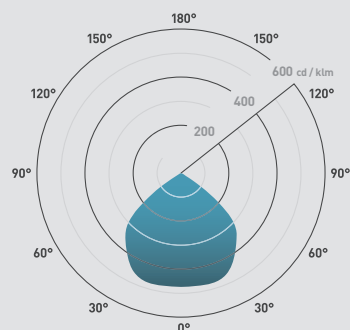

150



LED LYTE SURFACE

Surface-mount LED mini light

FEATURES

Wattage	1W
IP rating	IP65
Colour flexibility	Fixed colour
Tilttable	No
Rotatable	No
Dimmable	No
Input	350mA
LED lifetime	70,000h L70 B10
SDCM	3SDCM

INSTALLATION INFORMATION

Cut out size	N/A
Bathroom zone	1
Inrush current	N/A
Construction material	Anodised aluminium
Weight	900g
Maximum ambient temperature	35°C
Electric class (1, 2, 3)	3

PHOTOMETRICS @ 25°C

Product code	Colour	Beam angle	CRI	lm	lm/W	lx at 1m
LED LYTE SURFACE NW	4000K	110°	>70Ra	82	82	46
LED LYTE SURFACE WW	3000K	110°	>80Ra	63	63	30
LED LYTE SURFACE 27	2700K	110°	>80Ra	61	61	29

WIRING INFORMATION

Cable / flying lead	1m (0.205mm ² red & black PTFE)
Type of wiring required	Series

LED DRIVERS

Product code	Input	SELV	Dimming	Bathroom zone	Min	Max
PLU/PP/350 1-9 (Plug & play)	-	Yes	No	1	1	9
PLR/350 1-5	-	Yes	No	1	1	5
PLD UNI-DRIVE 350mA	-	Yes	Yes (1-10V)	2	1	10

ACCESSORIES

LED LYTE 1M EXT	1m plug & play extension lead	Sold separately	154
LED LYTE 6 WAY EXT	6-way 1m plug & play extension lead	Sold separately	154
PDC/GRID DIMMER	Grid dimmer kit for multiple fitting types	Sold separately	422

Decorative wall lights.

01604 495 151
collingwoodlighting.com

 @collingwoodLED

 /collingwoodlighting

 collingwoodled

GUARANTEE / WARRANTY

7 year extended warranty

FEATURES & BENEFITS

Plug & play connector for quick installation

Small & discreet

Ideal for decorative lighting



LED LYTE IP

IP rated mini LED light

FEATURES

Wattage	1W
IP rating	IP65
Colour flexibility	Fixed colour
Tilttable	No
Rotatable	No
Dimmable	No
Input	350mA
LED lifetime	70,000h L70 B10
SDCM	3SDCM

INSTALLATION INFORMATION

Cut out size	Ø 26mm
Bathroom zone	1
Inrush current	N/A
Construction material	Anodised aluminium
Weight	44g
Maximum ambient temperature	35°C
Electric class (1, 2, 3)	3

PHOTOMETRICS @ 25°C

Product code	Colour	Beam angle	CRI	lm	lm/W	lx at 1m
LED LYTE IP NW	4000K	110°	>70Ra	82	82	46
LED LYTE IP WW	3000K	110°	>80Ra	63	63	30
LED LYTE IP 27	2700K	110°	>80Ra	58	58	29
LED LYTE IP AMB	Amber	110°	-	-	-	-
LED LYTE IP BL	Blue	110°	-	-	-	-
LED LYTE IP GR	Green	110°	-	-	-	-
LED LYTE IP RED	Red	110°	-	-	-	-

WIRING INFORMATION

Cable / flying lead	1m (0.205mm ² red & black PTFE)
Type of wiring required	Series

LED DRIVERS

Product code	Input	SELV	Dimming	Bathroom zone	Min	Max
PLU/PP/350 1-9 (Plug & play)	-	Yes	No	1	1	9
PLR/350 1-5	-	Yes	No	1	1	5
PLD UNI-DRIVE 350mA	-	Yes	Yes (1-10V)	2	1	10

ACCESSORIES

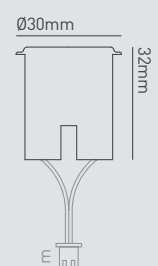
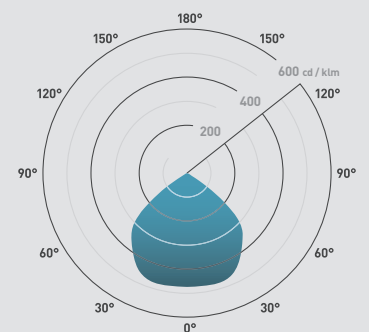

LED LYTE 1M EXT	1m plug & play extension lead	Sold separately	154
LED LYTE 6 WAY EXT	6-way 1m plug & play extension lead	Sold separately	154
PDC/GRID DIMMER	Grid dimmer kit for multiple fitting types	Sold separately	422

Beam angle: 110°



Decorative wall lights.

01604 495 151
collingwoodlighting.com

 @collingwoodLED
 /collingwoodlighting
 collingwoodled

GUARANTEE / WARRANTY

7 year extended warranty

FEATURES & BENEFITS

Plug & play connector for quick installation
Thread and nut for secure fitting
Small & discreet

Beam angle: 110°

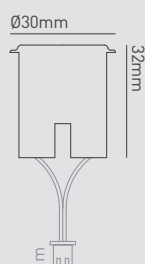
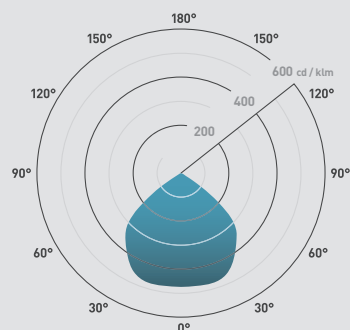

LED LYTE IP T

IP rated threaded mini LED light

FEATURES

Wattage	1W
IP rating	IP65
Colour flexibility	Fixed colour
Tilttable	No
Rotatable	No
Dimmable	No
Input	350mA
LED lifetime	70,000h L70 B10
SDCM	3SDCM

INSTALLATION INFORMATION

Cut out size	Ø 26mm
Bathroom zone	1
Inrush current	N/A
Construction material	Anodised aluminium
Weight	44g
Maximum ambient temperature	35°C
Electric class (1, 2, 3)	3

PHOTOMETRICS @ 25°C

Product code	Colour	Beam angle	CRI	lm	lm/W	lx at 1m
LED LYTE IP T NW	4000K	110°	>70Ra	82	82	46
LED LYTE IP T 27	2700K	110°	>80Ra	58	58	29
LED LYTE IP T BL	Blue	110°	-	-	-	-

WIRING INFORMATION

Cable / flying lead	1m (0.205mm ² red & black PTFE)
Type of wiring required	Series

LED DRIVERS

Product code	Input	SELV	Dimming	Bathroom zone	Min	Max
PLU/PP/350 1-9 (Plug & play)	-	Yes	No	1	1	9
PLR/350 1-5	-	Yes	No	1	1	5
PLD UNI-DRIVE 350mA	-	Yes	Yes (1-10V)	2	1	10

ACCESSORIES

LED LYTE 1M EXT	1m plug & play extension lead	Sold separately	154
LED LYTE 6 WAY EXT	6-way 1m plug & play extension lead	Sold separately	154
PDC/GRID DIMMER	Grid dimmer kit for multiple fitting types	Sold separately	422

Decorative wall lights.

01604 495 151
collingwoodlighting.com

 @collingwoodLED

 /collingwoodlighting

 collingwoodled

GUARANTEE / WARRANTY

7 year extended warranty

FEATURES & BENEFITS

Plug & play connector for quick installation

Small & discreet

Ideal for decorative lighting



LED LYTE

Mini LED light

FEATURES

Wattage	1W
IP rating	IP30
Colour flexibility	Fixed colour
Tilttable	No
Rotatable	No
Dimmable	No
Input	350mA
LED lifetime	70,000h L70 B10
SDCM	3SDCM

INSTALLATION INFORMATION

Cut out size	Ø 26mm
Bathroom zone	N/A
Inrush current	N/A
Construction material	Plastic
Weight	20g
Maximum ambient temperature	35°C
Electric class (1, 2, 3)	3

PHOTOMETRICS @ 25°C

Product code	Colour	Beam angle	CRI	lm	lm/W	lx at 1m
LED LYTE NW	4000K	110°	>70Ra	82	82	46
LED LYTE WW	3000K	110°	>80Ra	60	60	30
LED LYTE 27	2700K	110°	>80Ra	58	58	29
LED LYTE AMBER	Amber	110°	-	-	-	-
LED LYTE BLUE	Blue	110°	-	-	-	-
LED LYTE RED	Red	110°	-	-	-	-

WIRING INFORMATION

Cable / flying lead	1m (0.205mm ² red & black PTFE)
Type of wiring required	Series

LED DRIVERS

Product code	Input	SELV	Dimming	Bathroom zone	Min	Max
PLU/PP/350 1-9 (Plug & play)	-	Yes	No	-	1	9
PLR/350 1-5	-	Yes	No	-	1	5
PLD UNI-DRIVE 350mA	-	Yes	Yes (1-10V)	-	1	10

ACCESSORIES

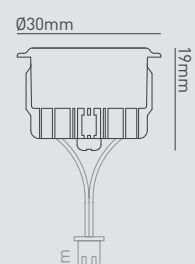
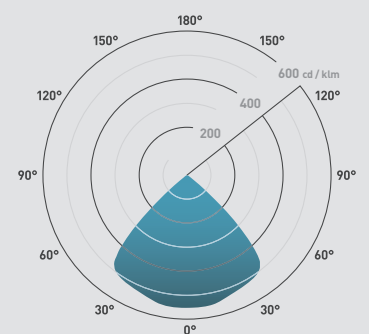

LED LYTE 1M EXT	1m plug & play extension lead	Sold separately	154
LED LYTE 6 WAY EXT	6-way 1m plug & play extension lead	Sold separately	154
PDC/GRID DIMMER	Grid dimmer kit for multiple fitting types	Sold separately	422

Beam angle: 110°



Decorative wall lights.

01604 495 151
collingwoodlighting.com

-  @collingwoodLED
-  /collingwoodlighting
-  collingwoodled

GUARANTEE / WARRANTY

1 year extended warranty

FEATURES & BENEFITS

Plug & play connectivity removes the need for traditional time consuming wiring

Each ext. socket can be used for additional LED

Complete circuit with LED or blanking plug

LED LYTE 1M EXT

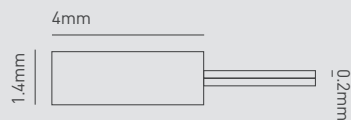

LED LYTE 6 WAY EXT

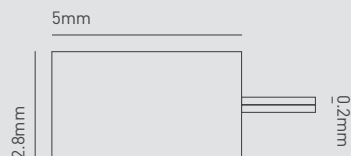

LED LYTE 1M EXT | LED LYTE 6 WAY EXT

1m extension lead | 6-way 1m extension lead

INSTALLATION INFORMATION

Construction material	Plastic
Weight	LED LYTE 1M EXT: 23g LED LYTE 6 WAY EXT: 13.8g

PRODUCT CODES

Product code	Description
LED LYTE 1M EXT	1m extension lead
LED LYTE 6 WAY EXT	6-way 1m extension lead

WIRING INFORMATION

Cable / flying lead	1m (0.205mm ² red & black PTFE)
Type of wiring required	Series

USE WITH

DL120	Mini adjustable LED spot light
DL130	Mini adjustable LED spot light
LED LYTE	Mini LED light
LED LYTE IP	IP rated mini LED light
LED LYTE IP T	IP rated threaded mini LED light
LED LYTE SURFACE	Surface-mount LED mini light
PLU/PP/350 1-9	Driver
WL050	LED wall / step light



LED strip.

Flexible or rigid, Collingwood Lighting's wide offering of LED strip lights are a time efficient way of creating stunning results in almost any environment. We offer a comprehensive range of accessories designed to ensure that installing these products is quick and easy. Choose from a range of styles and LED colours to emphasise signs, stairs and walls. Collingwood's LED products contain output control technology, ensuring that all LEDs in the strip receive the same current are the same colour temperature and CRI throughout the entire length.

Including IP rated strips in the product portfolio allows the option to install both in and outdoors, with very little maintenance required over time. Combined with the appropriate connectors, the need for unsightly wiring on display is eliminated, allowing the product to be displayed around sharp corners, resulting in a high-quality finish for any installation.



Choosing LED strip.

Find the ideal LED strip for your installation

Follow the three easy steps below to determine the perfect LED strip for your installation.

1

Where are you using your LED strip?

What IP rating do you require?

IP20

Indoor spaces

For indoor spaces such as living rooms, dining rooms and other living spaces, IP20 LED strip is the most suitable choice.



2

Do you need primary or secondary lighting?

How powerful does the LED strip need to be?

4.8W

Secondary lighting

4.8W LED strip is ideal for task lighting, under cabinets and kickboards.



3

How warm or cool is the atmosphere of the room required?

What colour temperature do you need?

2700K

Warmest

For a warm and intimate feel, use 2700K.



Now you've narrowed your requirements, use the tables on the next page to determine the correct LED strip for you.

IP44

Indoor spaces near water

For indoor spaces such as kitchens or bathrooms, IP44 LED strip is the ideal choice.



IP68

When cut the LED strip becomes IP65.

Outdoor spaces & under water

For outdoor spaces, IP65 and above is perfect. When installing LED strip under water, IP68 is the only choice.

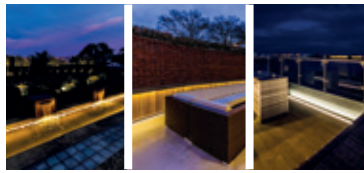

9.6W

Secondary lighting

9.6W LED strip is a suitable solution for accent lighting used in coves to create atmosphere.



14.4W

Primary lighting

14.4W LED strip can be used for lighting a room utilising coves.

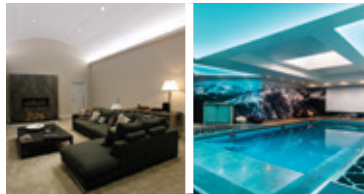

19.2W

Primary lighting

19.2W LED strip is ideal for lighting up a room with higher ceilings or with exposed beams.

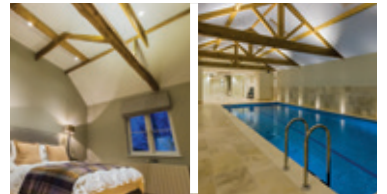

3000K

Warm

For the warmth of a halogen, use 3000K.



4000K

Natural white

To replicate the look of daylight, use 4000K.



6500K

Cool

For a cool, crisp look, use 6500K.



Choosing LED strip.

Find the ideal LED strip for your installation

Having identified the IP rating, wattage and colour temperature required, use the tables below to ascertain which LED strip will suit your installation.

- 1 **Locate the correct IP rating**
 - 2 **Continue across the table to identify the wattage required**
 - 3 **Finally, select the relevant colour temperature**
- ✓ **This will provide you with the LED strip part code you'll need to place your order**

Premium

Our premium Collingwood LED strip utilises constant current technology to ensure there is no loss in light output, regardless of how long the strip is or how far away the driver is.

Partcode	IP rating	Wattage	Colour temperature
LSC0327050 <small>Page 183</small>	IP20	4.8W/m	2700K
LSC0330050 <small>Page 183</small>	IP20	4.8W/m	3000K
LSC0340050 <small>Page 183</small>	IP20	4.8W/m	4000K
LSC4327050 <small>Page 184</small>	IP44	4.8W/m	2700K
LSC4330050 <small>Page 184</small>	IP44	4.8W/m	3000K
LSC4340050 <small>Page 184</small>	IP44	4.8W/m	4000K
LSC4527050 <small>Page 185</small>	IP44	14.4W/m	2700K
LSC4530050 <small>Page 185</small>	IP44	14.4W/m	3000K
LSC4540050 <small>Page 185</small>	IP44	14.4W/m	4000K
LEDSTRIP IP WW <small>Page 187</small>	IP66	2.9W/m	3000K
LEDSTRIP IP NW <small>Page 187</small>	IP66	2.9W/m	4000K
LSC8327050 <small>Page 186</small>	IP68	4.8W/m	2700K
LSC8330050 <small>Page 186</small>	IP68	4.8W/m	3000K
LSC8340050 <small>Page 186</small>	IP68	4.8W/m	4000K

Essentially Collingwood

Our Essentially Collingwood LED strip utilises constant voltage, making it the perfect solution for shorter distances as there will be no loss of light output up to 5m.

Partcode	IP rating	Wattage	Colour temperature
LSV0227050 <small>Page 168</small>	IP20	4.8W/m	2700K
LSV0230050 <small>Page 168</small>	IP20	4.8W/m	3000K
LSV0240050 <small>Page 168</small>	IP20	4.8W/m	4000K
LSV0265050 <small>Page 168</small>	IP20	4.8W/m	6500K
LSV0527050 <small>Page 169</small>	IP20	9.6W/m	2700K
LSV0530050 <small>Page 169</small>	IP20	9.6W/m	3000K
LSV0540050 <small>Page 169</small>	IP20	9.6W/m	4000K
LSV0565050 <small>Page 169</small>	IP20	9.6W/m	6500K
LSV0427050 <small>Page 170</small>	IP20	14.4W/m	2700K
LSV0430050 <small>Page 170</small>	IP20	14.4W/m	3000K
LSV0440050 <small>Page 170</small>	IP20	14.4W/m	4000K
LSV0465050 <small>Page 170</small>	IP20	14.4W/m	6500K
LSV0627050 <small>Page 171</small>	IP20	19.2W/m	2700K
LSV0630050 <small>Page 171</small>	IP20	19.2W/m	3000K
LSV0640050 <small>Page 171</small>	IP20	19.2W/m	4000K
LSV0665050 <small>Page 171</small>	IP20	19.2W/m	6500K

Premium

IP20 Indoor spaces

IP44 Indoor spaces near water

IP68 Outdoor spaces and under water

When cut, the LED strip becomes IP65. This is still appropriate for outdoor use but cannot be used under water.

Wattage

4.8W Secondary lighting

9.6W Secondary lighting

14.4W Primary lighting

19.2W Primary lighting

Colour temperature

2700K Warmest

3000K Warm

4000K Natural white

6500K Cool

Partcode	IP rating	Wattage	Colour temperature
LSV4227050 <small>Page 172</small>	IP44	4.8W/m	2700K
LSV4230050 <small>Page 172</small>	IP44	4.8W/m	3000K
LSV4240050 <small>Page 172</small>	IP44	4.8W/m	4000K
LSV4265050 <small>Page 172</small>	IP44	4.8W/m	6500K
LSV4527050 <small>Page 173</small>	IP44	9.6W/m	2700K
LSV4530050 <small>Page 173</small>	IP44	9.6W/m	3000K
LSV4540050 <small>Page 173</small>	IP44	9.6W/m	4000K
LSV4565050 <small>Page 173</small>	IP44	9.6W/m	6500K
LSV4427050 <small>Page 174</small>	IP44	14.4W/m	2700K
LSV4430050 <small>Page 174</small>	IP44	14.4W/m	3000K
LSV4440050 <small>Page 174</small>	IP44	14.4W/m	4000K
LSV4465050 <small>Page 174</small>	IP44	14.4W/m	6500K
LSV4627050 <small>Page 175</small>	IP44	19.2W/m	2700K
LSV4630050 <small>Page 175</small>	IP44	19.2W/m	3000K
LSV4640050 <small>Page 175</small>	IP44	19.2W/m	4000K
LSV4665050 <small>Page 175</small>	IP44	19.2W/m	6500K

Partcode	IP rating	Wattage	Colour temperature
LSV8227050 <small>Page 176</small>	IP68 (IP65 when cut)	4.8W/m	2700K
LSV8230050 <small>Page 176</small>	IP68 (IP65 when cut)	4.8W/m	3000K
LSV8240050 <small>Page 176</small>	IP68 (IP65 when cut)	4.8W/m	4000K
LSV8265050 <small>Page 176</small>	IP68 (IP65 when cut)	4.8W/m	6500K
LSV8527050 <small>Page 177</small>	IP68 (IP65 when cut)	9.6W/m	2700K
LSV8530050 <small>Page 177</small>	IP68 (IP65 when cut)	9.6W/m	3000K
LSV8540050 <small>Page 177</small>	IP68 (IP65 when cut)	9.6W/m	4000K
LSV8565050 <small>Page 177</small>	IP68 (IP65 when cut)	9.6W/m	6500K
LSV8427050 <small>Page 178</small>	IP68 (IP65 when cut)	14.4W/m	2700K
LSV8430050 <small>Page 178</small>	IP68 (IP65 when cut)	14.4W/m	3000K
LSV8440050 <small>Page 178</small>	IP68 (IP65 when cut)	14.4W/m	4000K
LSV8465050 <small>Page 178</small>	IP68 (IP65 when cut)	14.4W/m	6500K
LSV8627050 <small>Page 179</small>	IP68 (IP65 when cut)	19.2W/m	2700K
LSV8630050 <small>Page 179</small>	IP68 (IP65 when cut)	19.2W/m	3000K
LSV8640050 <small>Page 179</small>	IP68 (IP65 when cut)	19.2W/m	4000K
LSV8665050 <small>Page 179</small>	IP68 (IP65 when cut)	19.2W/m	6500K

Choosing profile for LED strip.

Find the ideal profile for your installation

We recommend housing your LED strip in a profile to provide a clean, flat surface and professional finish.

Recessed profile

Ideal for recessing into walled material to blend seamlessly and create flat surfaces.

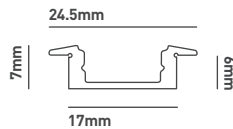
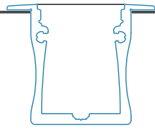

RP7

7mm deep recessed anodised aluminium profile and translucent diffuser (not compatible with IP68 LED Strip)

Product code	1m: RP7010 2m: RP7020
Construction material	Anodised aluminium & plastic diffuser
Guarantee	1 year

Accessories (supplied with profile)	
RP7ECA / RP7ECB End cap	

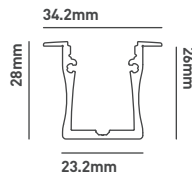

RP28

28mm deep recessed anodised aluminium profile and translucent diffuser

Product code	1m: RP28010 2m: RP28020
Construction material	Anodised aluminium & plastic diffuser
Guarantee	1 year

Accessories (supplied with profile)	
End cap (not sold separately)	

Surface-mount profile

Perfect for use in ceiling voids, shelves and under cabinets to create a clean and effective installation.

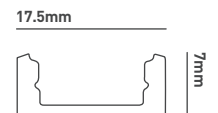
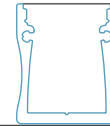

SM7

7mm slim surface-mount anodised aluminium profile and translucent diffuser (not compatible with IP68 LED Strip)

Product code	1m: SM7010 2m: SM7020
Construction material	Anodised aluminium & plastic diffuser
Guarantee	1 year

Accessories (supplied with profile)		Accessories (sold separately)
SM7ECA / SM7ECB End cap	SM7MA Mounting bracket	SM7LC Linear connector

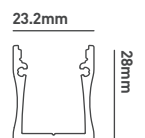

SM28

28mm deep surface-mount anodised aluminium profile and translucent diffuser

Product code	1m: SM28010 2m: SM28020
Construction material	Anodised aluminium & plastic diffuser
Guarantee	1 year

Accessories (supplied with profile)	
SM28ECA End cap	SM28MB Mounting bracket

Floor profile

These are perfect for surface mounting whereby the strip can be walked over. This profile is also specifically convex shaped so that the installation will not become a trip hazard.

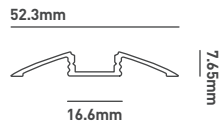

CX7

7mm slim surface-mount anodised aluminium profile and translucent diffuser (not compatible with IP68 LED Strip)

Product code	1m: CX7010 2m: CX7020
Construction material	Anodised aluminium & plastic diffuser
Guarantee	1 year

Accessories (sold separately)

CX7ECA / CX7ECB End cap		CX7ECC / CX7ECD End cap with holding ears	
----------------------------	--	--	--

Surface-mount corner profile

Ideal for installing into a 90° corner, which is ideal for use under shelving and cabinets for a seamless installation.

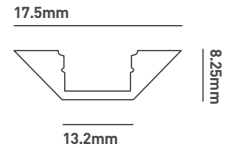

C07

45° slim surface-mount corner anodised aluminium profile and translucent diffuser (not compatible with IP68 LED Strip)

Product code	1m: C07010 2m: C07020
Construction material	Anodised aluminium & plastic diffuser
Guarantee	1 year

Accessories (sold separately)

C07ECA / C07ECB End cap		C07MB Mounting bracket	
----------------------------	--	---------------------------	--

7mm deep profile

A thinner, recessed profile will fit into thinner materials. Using a slimmer, surface-mount profile allows for a more discreet output when surface mounted.

28mm deep profile

Using a deeper profile will result in a diffused light, creating a softer ambience.

Choosing profile for LEDSTRIP IP.

Find the ideal profile for your installation

We recommend housing your LED strip in a profile to provide a clean, flat surface and professional finish.

Recessed profile

Ideal for recessing into walled material to blend seamlessly and create flat surfaces.

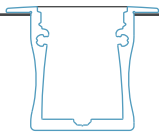

Line profile 20mm 1m

Recessed profile for LEDSTRIP IP

Product code	1m: LEDLINE PROFILE 20MM 1M
Construction material	Anodised aluminium & plastic diffuser
Guarantee	1 year

Accessories (sold separately)

Line prof end cap
End cap



Line prof fix clip
Fixes profile to surfaces



Acrylic cover
Clear acrylic cover



Surface-mount profile

Perfect for use in ceiling voids, shelves and under cabinets to create a clean and effective installation.

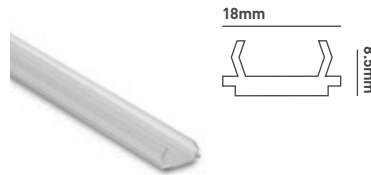
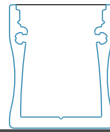

U profile 6 x 12 1m

8.5mm slim surface-mount

Product code	1m: U PROFILE 6X12 1M
Construction material	PVC plastic
Guarantee	1 year

Floor profile

These are perfect for surface mounting whereby the strip can be walked over. This profile is also specifically convex shaped so that the installation will not become a trip hazard.

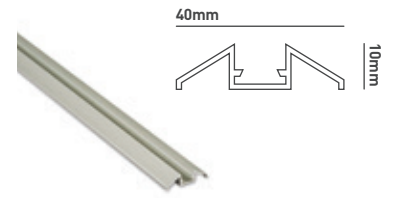

Profile 6 x 12

Floor / wall profile for LEDSTRIP IP

Product code	Black: PROF6X12BLK Silver: PROF6X12SIL
Construction material	Anodised aluminium
Guarantee	1 year

Stair profile

Suitable for installing into a 90° corner, which is ideal for use under shelving and cabinets for a seamless installation.

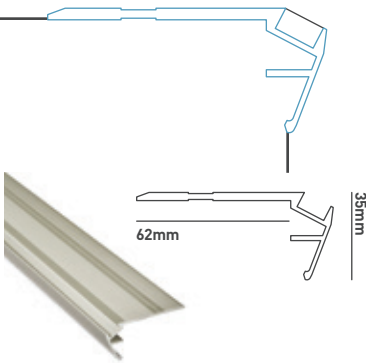

Stair profile

Stair nosing for LEDSTRIP IP

Product code	Black: SPBLK2M Silver: SPSIL2M
Construction material	Anodised aluminium
Guarantee	1 year

LED cove packs.

Add a professional finish

Cove packs are a great way to illuminate a room by reflecting light off of a ceiling.



LED cove pack

Coving to house adhesive LED strip

Product code	BLED COVE PACK
Construction material	Plastic
Guarantee	1 year

Accessories (supplied with profile)	
LED cove clip Fixing clip	



Why choose a cove pack?

Using a cove pack helps to create a sleek and contemporary finish when directing light from LED strip on to the ceiling. Pointing the strip upwards creates a striking wash of light up the wall as well as light hitting the ceiling and reflecting back to illuminate the room.

This paintable, plastic coving is a complete housing for the quickest installation of an illuminated LED coving. An upper channel holds a flexible lighting strip and a lower, concealed channel directs all the cabling. This process requires a minimal amount of building or electrical work. Available in 1m lengths.

LED strip accessories.

Find the ideal connector for your LED strip

You may need additional connectors to extend your LED strip.

Compatible with
LSV02 & LSV05



LSBFC8

Connects LED strip to more LED strip

Product code LSBFC8

Connector cannot be used inside 7mm profile.

Compatible with
LSV04 & LSV06



LSBFC10

Connects LED strip to more LED strip

Product code LSFC10

Connector cannot be used inside 7mm profile.

Compatible with
LSC03



LSFC12

Connects LED strip to more LED strip

Product code LSFC12

Connector cannot be used inside 7mm profile.



LSBFCS8

Adds 150mm fly leads to LED strip

Product code LSBFCS8

Connector cannot be used inside 7mm profile.



LSBFCS10

Adds 150mm fly leads to LED strip

Product code LSBFCS10

Connector cannot be used inside 7mm profile.



LSFCS12

Adds 150mm fly leads to LED strip

Product code LSFCS12

Connector cannot be used inside 7mm profile.



LSBFCD8

Connects LED strip to more LED strip
with 150mm fly leads

Product code LSBFCD8

Connector cannot be used inside 7mm profile.



LSBFCD10

Connects LED strip to more LED strip
with 150mm fly leads

Product code LSBFCD8

Connector cannot be used inside 7mm profile.



LSFCD12

Connects LED strip to more LED strip
with 150mm fly leads

Product code LSBFCD8

Connector cannot be used inside 7mm profile.

Compatible with
LSC83



LSC8PWL

IP68 cable from driver to LED strip (JB6 to connect driver required)

Product code LSC8PWL

Connector cannot be used inside profile.



LSC8EXT

1m extension cable to extend LSC8PWL cable

Product code LSC8EXT

Connector cannot be used inside profile.

Compatible with
LEDSTRIP IP



Connector 6 x 12

Connects LED strip to more LED strip with fly leads

Product code CONNECTOR 6X12

Connector cannot be used inside profile.



CON EXT 6 x 12

1.85m extension lead to connect LED strip to more LED strip

Product code CONEXTMF6X12

Connector cannot be used inside profile.



L / T / X Connectors

L-connector, T-connector, X-connector

Product code L: CONNECTOR L 6X12
T: CONNECTOR T 6X12
X: CONNECTOR X 6X12

Connector cannot be used inside profile.



CON EXT Connectors



Connects LED strip to more LED strip with 150mm fly leads

Product code Male: CON MALE 6X12
Female: CON FEMALE 6X12

Connector cannot be used inside profile.

LED strips.

01604 495 151
collingwoodlighting.com

 @collingwoodLED
 /collingwoodlighting
 collingwoodled

GUARANTEE / WARRANTY

3 year extended warranty

FEATURES & BENEFITS

IP20 4.8W/m LED strip pack

Ideal for indoor use in a wide range of applications including task lighting

Excellent for secondary lighting

Cut points every 100mm

3M self-adhesive backing for secure and easy installation

Supplied in a resealable, antistatic bag to protect during transit

Beam angle: 120°

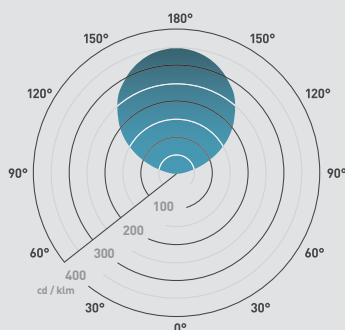

5m/100mm

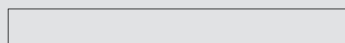

8mm



LSV02

Constant voltage, self-adhesive, flexible IP20 strip

FEATURES

Wattage	4.8W per metre
IP rating	IP20
Self-adhesive backing	Yes
Colour flexibility	Fixed colour
Input	Driver required (24V)
LED lifetime	30,000h
SDCM	5SDCM

INSTALLATION INFORMATION

Bathroom zone	N/A
Construction material	Flexible tape
Weight	53g per meter
Maximum ambient temperature	40°C
SELV	N/A (refer to LED DRIVERS section below)
Electric class (1, 2, 3)	3

PHOTOMETRICS @ 25°C

Product code	LED/m	Colour	Beam angle	CRI	lm	lm/W	lx at 1m
LSV0265050	60 LEDs/m	6500K	120°	>80Ra	560	117	183
LSV0240050	60 LEDs/m	4000K	120°	>80Ra	490	102	160
LSV0230050	60 LEDs/m	3000K	120°	>80Ra	450	94	147
LSV0227050	60 LEDs/m	2700K	120°	>80Ra	430	90	140

WIRING INFORMATION

Cable / flying lead	Supplied with a minimum of 200mm flying lead from one end
Type of wiring required	Parallel

LED DRIVERS

Product code	Input	SELV	Dimming	Bathroom zone	Min	Max
PS3024B	220V-240V	Yes	Yes (PDCINT1-10V)	-	-	5m
PSDIP6024	220V-240V	Yes	Yes	-	-	2 x 5m
PSDIP10024	220V-240V	Yes	Yes	-	-	3 x 5m



See page 406 for complete offer

ACCESSORIES

LSBFC8 / LSBFCS8 / LSBFCD8	Range of fast fix connectors for use with LSV02	Sold separately	166
LED STRIP PROFILE RANGE	Profile range to house adhesive strip	Sold separately	162
LED COVE PACK	Coving to house adhesive strip	Sold separately	165
PDC/GRID DIMMER	Grid dimmer kit for multiple fitting types	Sold separately	422
PDCINT1-10V	1-10V dimming interface for use with 24V LED drivers	Sold separately	412

LED strip.

01604 495 151
collingwoodlighting.com

-  @collingwoodLED
-  /collingwoodlighting
-  collingwoodled

GUARANTEE / WARRANTY

3 year extended warranty

FEATURES & BENEFITS

IP20 9.6W/m LED strip

Ideal for indoor use in a wide range of applications including accent lighting

Excellent for secondary lighting

Cut points every 100mm

3M self-adhesive backing for secure and easy installation

Supplied in a resealable, antistatic bag to protect during transit

Beam angle: 120°

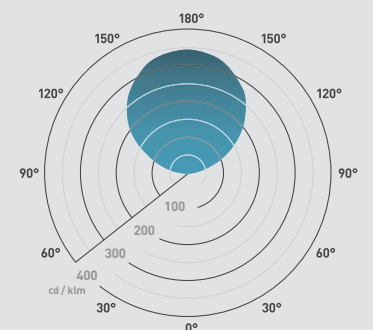

5m/100mm



LSV05

Constant voltage, self-adhesive, flexible IP20 strip

FEATURES

Wattage	9.6W per metre
IP rating	IP20
Self-adhesive backing	Yes
Colour flexibility	Fixed colour
Input	Driver required (24V)
LED lifetime	30,000h
SDCM	5SDCM

INSTALLATION INFORMATION

Bathroom zone	N/A
Construction material	Flexible tape
Weight	59g per meter
Maximum ambient temperature	40°C
SELV	N/A (refer to LED DRIVERS section below)
Electric class (1, 2, 3)	3

PHOTOMETRICS @ 25°C

Product code	LED/m	Colour	Beam angle	CRI	lm	lm/W	Lx at 1m
LSV0565050	120 LEDs/m	6500K	120°	>80Ra	960	100	316
LSV0540050	120 LEDs/m	4000K	120°	>80Ra	875	91	128
LSV0530050	120 LEDs/m	3000K	120°	>80Ra	800	83	263
LSV0527050	120 LEDs/m	2700K	120°	>80Ra	765	80	252

WIRING INFORMATION

Cable / flying lead	Supplied with a minimum of 200mm flying lead from one end
Type of wiring required	Parallel

LED DRIVERS

Product code	Input	SELV	Dimming	Bathroom zone	Min	Max
PS5024	220V-240V	Yes	Yes (PDCINT1-10V)	-	-	5m
PSIP24024	220V-240V	Yes	Yes	-	-	4 x 5m
PSDIP10024	220V-240V	Yes	Yes	-	-	2 x 5m



See page 406 for complete offer

ACCESSORIES

LSBFC8 / LSBFCS8 / LSBFCD8	Range of fast fix connectors for use with LSV05	Sold separately	166
LED STRIP PROFILE RANGE	Profile range to house adhesive strip	Sold separately	162
LED COVE PACK	Coving to house adhesive strip	Sold separately	165
PDC/GRID DIMMER	Grid dimmer kit for multiple fitting types	Sold separately	422
PDCINT1-10V	1-10V dimming interface for use with 24V LED drivers	Sold separately	412

LED strips.

01604 495 151
collingwoodlighting.com

-  @collingwoodLED
-  /collingwoodlighting
-  collingwoodled

GUARANTEE / WARRANTY

3 year extended warranty

FEATURES & BENEFITS

IP20 14.4W/m LED strip

Ideal for indoor use

Excellent for primary lighting and within coving

Cut points every 100mm

3M self-adhesive backing for secure and easy installation

Supplied in a resealable, antistatic bag to protect during transit

Beam angle: 120°

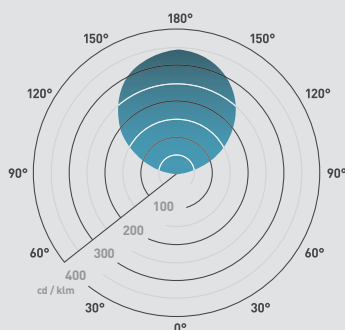

5m/100mm

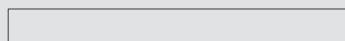

LSV04

Constant voltage, self-adhesive, flexible IP20 strip

FEATURES

Wattage	14.4W per metre
IP rating	IP20
Self-adhesive backing	Yes
Colour flexibility	Fixed colour
Input	Driver required (24V)
LED lifetime	30,000h
SDCM	5SDCM

INSTALLATION INFORMATION

Bathroom zone	N/A
Construction material	Flexible tape
Weight	81g per meter
Maximum ambient temperature	40°C
SELV	N/A (refer to LED DRIVERS section below)
Electric class (1, 2, 3)	3

PHOTOMETRICS @ 25°C

Product code	LED/m	Colour	Beam angle	CRI	lm	lm/W	lx at 1m
LSV0465050	60 LEDs/m	6500K	120°	>80Ra	1100	76	362
LSV0440050	60 LEDs/m	4000K	120°	>80Ra	1200	83	395
LSV0430050	60 LEDs/m	3000K	120°	>80Ra	1050	73	345
LSV0427050	60 LEDs/m	2700K	120°	>80Ra	875	61	288

WIRING INFORMATION

Cable / flying lead	Supplied with a minimum of 200mm flying lead from one end
Type of wiring required	Parallel

LED DRIVERS

Product code	Input	SELV	Dimming	Bathroom zone	Min	Max
PS5024	220V-240V	Yes	Yes (PDCINT1-10V)	-	-	3m
PSIP24024	220V-240V	Yes	Yes	-	-	3 x 5m
PS7524	220V-240V	Yes	Yes	-	-	5m

See page 406 for complete offer

ACCESSORIES

LSBFC10 / LSBFCS10 / LSBFCD10	Range of fast fix connectors for use with LSV04	Sold separately	166
LED STRIP PROFILE RANGE	Profile range to house adhesive strip	Sold separately	162
LED COVE PACK	Coving to house adhesive strip	Sold separately	165
PDC/GRID DIMMER	Grid dimmer kit for multiple fitting types	Sold separately	422
PDCINT1-10V	1-10V dimming interface for use with 24V LED drivers	Sold separately	412

LED strip.



LSV06

Constant voltage, self-adhesive, flexible IP20 strip

FEATURES

Wattage	19.2W per metre
IP rating	IP20
Self-adhesive backing	Yes
Colour flexibility	Fixed colour
Input	Driver required (24V)
LED lifetime	30,000h
SDCM	5SDCM

INSTALLATION INFORMATION

Bathroom zone	N/A
Construction material	Flexible tape
Weight	83g per meter
Maximum ambient temperature	40°C
SELV	N/A (refer to LED DRIVERS section below)
Electric class (1, 2, 3)	3

PHOTOMETRICS @ 25°C

Product code	LED/m	Colour	Beam angle	CRI	lm	lm/W	Lx at 1m
LSV0665050	120 LEDs/m	6500K	120°	>80Ra	1920	100	631
LSV0640050	120 LEDs/m	4000K	120°	>80Ra	1745	91	574
LSV0630050	120 LEDs/m	3000K	120°	>80Ra	1600	83	526
LSV0627050	120 LEDs/m	2700K	120°	>80Ra	1525	79	502

WIRING INFORMATION

Cable / flying lead	Supplied with a minimum of 200mm flying lead from one end
Type of wiring required	Parallel

LED DRIVERS

Product code	Input	SELV	Dimming	Bathroom zone	Min	Max
PSDIP6024	220V-240V	Yes	Yes (PDCINT1-10V)	-	-	3m
PSIP24024	220V-240V	Yes	Yes	-	-	2 x 5m
PSDIP10024	220V-240V	Yes	Yes	-	-	5m

See page 406 for complete offer

ACCESSORIES

LSBFC10 / LSBFCS10 / LSBFCD10	Range of fast fix connectors for use with LSV06	Sold separately	166
LED STRIP PROFILE RANGE	Profile range to house adhesive strip	Sold separately	162
LED COVE PACK	Coving to house adhesive strip	Sold separately	165
PDC/GRID DIMMER	Grid dimmer kit for multiple fitting types	Sold separately	422
PDCINT1-10V	1-10V dimming interface for use with 24V LED drivers	Sold separately	412

01604 495 151
collingwoodlighting.com

- @collingwoodLED
- /collingwoodlighting
- collingwoodled

GUARANTEE / WARRANTY

3 year extended warranty

FEATURES & BENEFITS

IP20 19.2W/m LED strip

Ideal for indoor use in a wide range of applications including accent lighting

Excellent for primary lighting with high ceilings and exposed beams

Cut points every 100mm

3M self-adhesive backing for secure and easy installation

Supplied in a resealable, antistatic bag to protect during transit

Beam angle: 120°

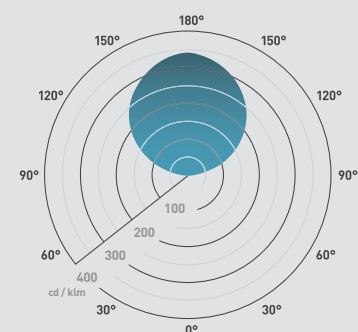

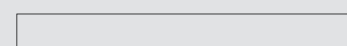

5m/100mm



10mm

LED strips.

01604 495 151
collingwoodlighting.com

 @collingwoodLED
 /collingwoodlighting
 collingwoodled

GUARANTEE / WARRANTY

3 year extended warranty

FEATURES & BENEFITS

IP44 4.8W/m LED strip
Ideal for use in kitchens and bathrooms
Excellent for secondary lighting
Cut points every 100mm
3M self-adhesive backing for secure and easy installation
Supplied in a resealable, antistatic bag to protect during transit
Also available in a convenient strip box, complete with a driver. These are ideal for smaller installations

Beam angle: 120°

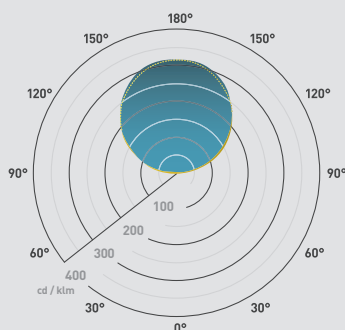

5m/100mm

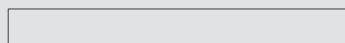

8mm



LSV42

Constant voltage, self-adhesive, flexible IP44 strip

FEATURES

Wattage	4.8W per metre
IP rating	IP44
Self-adhesive backing	Yes
Colour flexibility	Fixed colour
Input	Driver required (24V)
LED lifetime	30,000h
SDCM	5SDCM

INSTALLATION INFORMATION

Bathroom zone	1
Construction material	Flexible tape with PU coating
Weight	150g per meter
Maximum ambient temperature	65°C
SELV	N/A (refer to LED DRIVERS section below)
Electric class (1, 2, 3)	3

PHOTOMETRICS @ 25°C

Product code	LED/m	Colour	Beam angle	CRI	lm	lm/W	lx at 1m
LSV4265050	60 LEDs/m	6500K	120°	>80Ra	475	99	153
LSV4240050	60 LEDs/m	4000K	120°	>80Ra	415	86	134
LSV4230050	60 LEDs/m	3000K	120°	>80Ra	385	80	124
LSV4227050	60 LEDs/m	2700K	120°	>80Ra	380	79	122

WIRING INFORMATION

Cable / flying lead	Supplied with a minimum of 200mm flying lead from one end
Type of wiring required	Parallel

LED DRIVERS

Product code	Input	SELV	Dimming	Bathroom zone	Min	Max
PS3024B	220V-240V	Yes	Yes (PDCINT1-10V)	-	-	5m
PSDIP6024	220V-240V	Yes	Yes	-	-	2 x 5m
PSDIP10024	220V-240V	Yes	Yes	-	-	3 x 5m



See page 406 for complete offer

ACCESSORIES

LSBFC8 / LSBFCS8 / LSBFCD8	Range of fast fix connectors for use with LSV42	Sold separately	166
LED STRIP PROFILE RANGE	Profile range to house adhesive strip	Sold separately	162
LED COVE PACK	Coving to house adhesive strip	Sold separately	165
PDC/GRID DIMMER	Grid dimmer kit for multiple fitting types	Sold separately	422
PDCINT1-10V	1-10V dimming interface for use with 24V LED drivers	Sold separately	412

LED strip.

01604 495 151
collingwoodlighting.com

 @collingwoodLED
 /collingwoodlighting
 collingwoodled

GUARANTEE / WARRANTY

3 year extended warranty

FEATURES & BENEFITS

IP44 9.6W/m LED strip

Ideal for use in kitchens and bathrooms

Excellent for secondary lighting

Cut points every 100mm

3M self-adhesive backing for secure and easy installation

Supplied in a resealable, antistatic bag to protect during transit



LSV45

Constant voltage, self-adhesive, flexible IP44 strip

FEATURES

Wattage	9.6W per metre
IP rating	IP44
Self-adhesive backing	Yes
Colour flexibility	Fixed colour
Input	Driver required (24V)
LED lifetime	30,000h
SDCM	5SDCM

INSTALLATION INFORMATION

Bathroom zone	2
Construction material	Flexible tape
Weight	150g per meter
Maximum ambient temperature	40°C
SELV	N/A (refer to LED DRIVERS section below)
Electric class (1, 2, 3)	3

PHOTOMETRICS @ 25°C

Product code	LED/m	Colour	Beam angle	CRI	lm	lm/W	lx at 1m
LSV4565050	120 LEDs/m	6500K	100°	>80Ra	815	85	279
LSV4540050	120 LEDs/m	4000K	100°	>80Ra	745	78	255
LSV4530050	120 LEDs/m	3000K	100°	>80Ra	680	71	233
LSV4527050	120 LEDs/m	2700K	100°	>80Ra	650	68	223

WIRING INFORMATION

Cable / flying lead	Supplied with a minimum of 200mm flying lead from one end
Type of wiring required	Parallel

LED DRIVERS

Product code	Input	SELV	Dimming	Bathroom zone	Min	Max
PS5024	220V-240V	Yes	Yes (PDCINT1-10V)	-	-	5m
PSIP24024	220V-240V	Yes	Yes	-	-	4 x 5m
PSDIP10024	220V-240V	Yes	Yes	-	-	2 x 5m

See page 406 for complete offer

ACCESSORIES

LED STRIP PROFILE RANGE	Profile range to house adhesive strip	Sold separately	162
PDCINT1-10V	1-10V dimming interface for use with 24V LED drivers	Sold separately	412

Beam angle: 100°

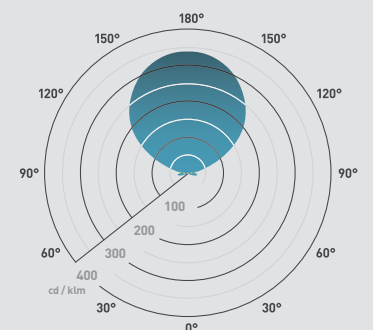

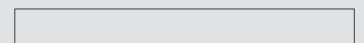

5m/100mm



8mm

LED strips.

01604 495 151
collingwoodlighting.com

 @collingwoodLED
 /collingwoodlighting
 collingwoodled

GUARANTEE / WARRANTY

3 year extended warranty

FEATURES & BENEFITS

IP44 14.4W/m LED strip

Ideal for use in kitchens and bathrooms

Excellent for primary lighting and within coving

Cut points every 100mm

3M self-adhesive backing for secure and easy installation

Supplied in a resealable, antistatic bag to protect during transit

Beam angle: 100°

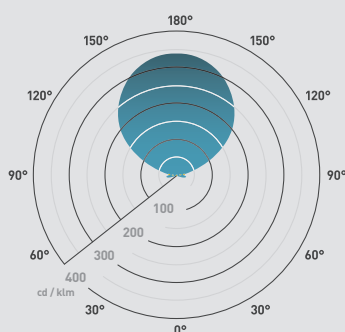

5m/100mm

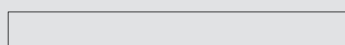

10mm



LSV44

Constant voltage, IP44, self-adhesive 5m LED strip

FEATURES

Wattage	14.4W per metre
IP rating	IP44
Self-adhesive backing	Yes
Colour flexibility	Fixed colour
Input	Driver required (24V)
LED lifetime	30,000h
SDCM	5SDCM

INSTALLATION INFORMATION

Bathroom zone	2
Construction material	Flexible tape with PU coating
Weight	196g per meter
Maximum ambient temperature	40°C
SELV	N/A (refer to LED DRIVERS section below)
Electric class (1, 2, 3)	3

PHOTOMETRICS @ 25°C

Product code	LED/m	Colour	Beam angle	CRI	lm	lm/W	lx at 1m
LSV4465050	60 LEDs/m	6500K	100°	>80Ra	935	65	301
LSV4440050	60 LEDs/m	4000K	100°	>80Ra	1000	69	322
LSV4430050	60 LEDs/m	3000K	100°	>80Ra	1100	76	354
LSV4427050	60 LEDs/m	2700K	100°	>80Ra	745	51	240

WIRING INFORMATION

Cable / flying lead	Supplied with a minimum of 200mm flying lead from one end
Type of wiring required	Parallel

LED DRIVERS

Product code	Input	SELV	Dimming	Bathroom zone	Min	Max
PS5024	220V-240V	Yes	Yes (PDCINT1-10V)	-	-	3m
PS7524	220V-240V	Yes	Yes	-	-	5m
PSIP24024	220V-240V	Yes	Yes	-	-	3 x 5m

See page 406 for complete offer

ACCESSORIES

LED STRIP PROFILE RANGE	Profile range to house adhesive strip	Sold separately	162
LED COVE PACK	Coving to house adhesive strip	Sold separately	165
PDC/GRID DIMMER	Grid dimmer kit for multiple fitting types	Sold separately	422
PDCINT1-10V	1-10V dimming interface for use with 24V LED drivers	Sold separately	412

LED strip.

01604 495 151
collingwoodlighting.com

 @collingwoodLED

 /collingwoodlighting

 collingwoodled

GUARANTEE / WARRANTY

3 year extended warranty

FEATURES & BENEFITS

IP44 19.2W/m LED strip

Ideal for use in kitchens and bathrooms

Excellent for primary lighting with high ceilings and exposed beams.

Cut points every 100mm

3M self-adhesive backing for secure and easy installation

Supplied in a resealable, antistatic bag to protect during transit

Beam angle: 120°

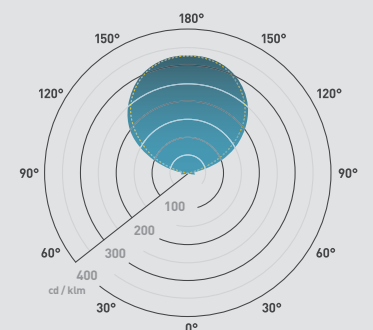

5m/100mm

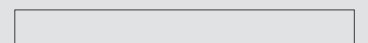

 10mm



LSV46

Constant voltage, IP44, self-adhesive 5m LED strip

FEATURES

Wattage	19.2W per metre
IP rating	IP44
Self-adhesive backing	Yes
Colour flexibility	Fixed colour
Input	Driver required (24V)
LED lifetime	30,000h
SDCM	5SDCM

INSTALLATION INFORMATION

Bathroom zone	2
Construction material	Flexible tape
Weight	200g per meter
Maximum ambient temperature	40°C
SELV	N/A (refer to LED DRIVERS section below)
Electric class (1, 2, 3)	3

PHOTOMETRICS @ 25°C

Product code	LED/m	Colour	Beam angle	CRI	lm	lm/W	lx at 1m
LSV4665050	120 LEDs/m	6500K	120°	>80Ra	1630	85	536
LSV4640050	120 LEDs/m	4000K	120°	>80Ra	1485	77	488
LSV4630050	120 LEDs/m	3000K	120°	>80Ra	1360	71	447
LSV4627050	120 LEDs/m	2700K	120°	>80Ra	1295	67	426

WIRING INFORMATION

Cable / flying lead	Supplied with a minimum of 200mm flying lead from one end
Type of wiring required	Parallel

LED DRIVERS

Product code	Input	SELV	Dimming	Bathroom zone	Min	Max
PSDIP6024	220V-240V	Yes	Yes (PDCINT1-10V)	-	-	3m
PSDIP10024	220V-240V	Yes	Yes	-	-	5m
PSIP24024	220V-240V	Yes	Yes	-	-	2 x 5m



See page 406 for complete offer

ACCESSORIES

LED STRIP PROFILE RANGE	Profile range to house adhesive strip	Sold separately	162
LED COVE PACK	Coving to house adhesive strip	Sold separately	165
PDC/GRID DIMMER	Grid dimmer kit for multiple fitting types	Sold separately	422
PDCINT1-10V	1-10V dimming interface for use with 24V LED drivers	Sold separately	412

LED strips.

01604 495 151
collingwoodlighting.com

 @collingwoodLED
 /collingwoodlighting
 collingwoodled

GUARANTEE / WARRANTY

3 year extended warranty

FEATURES & BENEFITS

IP68 4.8W/m LED strip

Ideal for use outside when waterproofing is required

Can be submerged in water permanently as a complete length

Any cuts are IP65

Excellent for secondary lighting

Cut points every 100mm (IP65 maximum)

Supplied in a resealable, antistatic bag to protect during transit

Not suitable for installation in chlorine or bromine environments

Beam angle: 120°

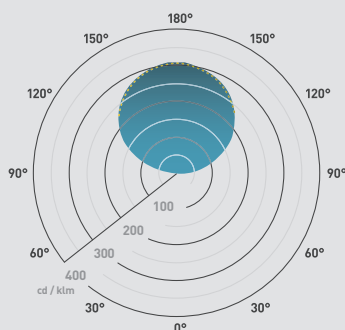

5m/100mm

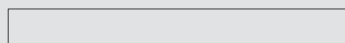

LSV82

Constant voltage, IP68, self-adhesive 5m LED strip

FEATURES

Wattage	4.8W per metre
IP rating	IP68
Self-adhesive backing	Yes
Colour flexibility	Fixed colour
Input	Driver required (24V)
LED lifetime	30,000h
SDCM	5SDCM

INSTALLATION INFORMATION

Bathroom zone	0
Construction material	Flexible tape
Weight	244g per meter
Maximum ambient temperature	40°C
SELV	N/A (refer to LED DRIVERS section below)
Electric class (1, 2, 3)	3

PHOTOMETRICS @ 25°C

Product code	LED/m	Colour	Beam angle	CRI	lm	lm/W	lx at 1m
LSV8265050	60 LEDs/m	6500K	120°	>80Ra	475	99	156
LSV8240050	60 LEDs/m	4000K	120°	>80Ra	415	86	136
LSV8230050	60 LEDs/m	3000K	120°	>80Ra	385	80	127
LSV8227050	60 LEDs/m	2700K	120°	>80Ra	365	76	120

WIRING INFORMATION

Cable / flying lead	Supplied with a minimum of 200mm flying lead from one end
Type of wiring required	Parallel

LED DRIVERS

Product code	Input	SELV	Dimming	Bathroom zone	Min	Max
PS3024B	220V-240V	Yes	Yes (PDCINT1-10V)	-	-	5m
PSDIP10024	220V-240V	Yes	Yes	-	-	3 x 5m
PSDIP6024	220V-240V	Yes	Yes	-	-	2 x 5m

See page 406 for complete offer

ACCESSORIES

PDC/GRID DIMMER	Grid dimmer kit for multiple fitting types	Sold separately	422
PDCINT1-10V	1-10V dimming interface for use with 24V LED drivers	Sold separately	412

LED strip.



LSV85

Constant voltage, IP68, self-adhesive 5m LED strip

FEATURES

Wattage	9.6W per metre
IP rating	IP68
Self-adhesive backing	Yes
Colour flexibility	Fixed colour
Input	Driver required (24V)
LED lifetime	30,000h
SDCM	5SDCM

INSTALLATION INFORMATION

Bathroom zone	0
Construction material	Flexible tape
Weight	250g per meter
Maximum ambient temperature	40°C
SELV	N/A (refer to LED DRIVERS section below)
Electric class (1, 2, 3)	3

PHOTOMETRICS @ 25°C

Product code	LED/m	Colour	Beam angle	CRI	lm	lm/W	lx at 1m
LSV8565050	120 LEDs/m	6500K	100°	>80Ra	815	85	279
LSV8540050	120 LEDs/m	4000K	100°	>80Ra	745	78	255
LSV8530050	120 LEDs/m	3000K	100°	>80Ra	680	71	233
LSV8527050	120 LEDs/m	2700K	100°	>80Ra	650	68	223

WIRING INFORMATION

Cable / flying lead	Supplied with a minimum of 200mm flying lead from one end
Type of wiring required	Parallel

LED DRIVERS

Product code	Input	SELV	Dimming	Bathroom zone	Min	Max
PS3024B	220V-240V	Yes	Yes (PDCINT1-10V)	-	-	5m
PSDIP10024	220V-240V	Yes	Yes	-	-	2 x 5m
PSIP24024	220V-240V	Yes	Yes	-	-	4 x 5m

See page 406 for complete offer

ACCESSORIES

PDC/GRID DIMMER	Grid dimmer kit for multiple fitting types	Sold separately	422
PDCINT1-10V	1-10V dimming interface for use with 24V LED drivers	Sold separately	412

01604 495 151
collingwoodlighting.com

- @collingwoodLED
- /collingwoodlighting
- collingwoodled

GUARANTEE / WARRANTY

3 year extended warranty

FEATURES & BENEFITS

IP68 9.6W/m LED strip

Ideal for use outside when waterproofing is required

Can be submerged in water permanently as a complete length

Any cuts are IP65

Excellent for secondary lighting

Cut points every 100mm (IP65 maximum)

Supplied in a resealable, antistatic bag to protect during transit

Not suitable for installation in chlorine or bromine environments

Beam angle: 100°

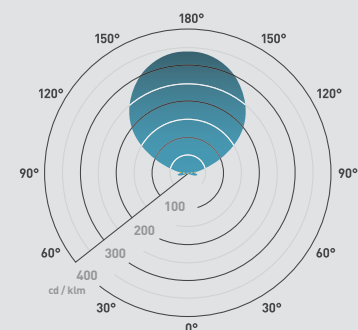

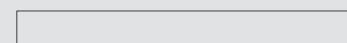

5m/100mm



10mm

LED strips.

01604 495 151
collingwoodlighting.com

-  @collingwoodLED
-  /collingwoodlighting
-  collingwoodled

GUARANTEE / WARRANTY

3 year extended warranty

FEATURES & BENEFITS

IP68 14.4W/m LED strip

Ideal for use outside when waterproofing is required

Can be submerged in water permanently as a complete length

Any cuts are IP65

Excellent for secondary lighting

Cut points every 100mm (IP65 maximum)

Supplied in a resealable, antistatic bag to protect during transit

Not suitable for installation in chlorine or bromine environments

Beam angle: 100°

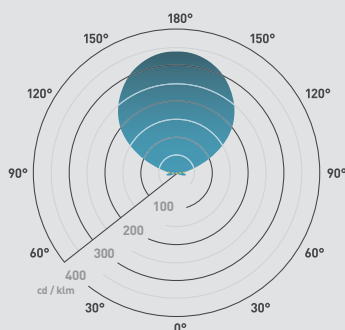

5m/100mm

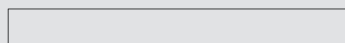

LSV84

Constant voltage, IP68, self-adhesive 5m LED strip

FEATURES

Wattage	14.4W per metre
IP rating	IP68
Self-adhesive backing	Yes
Colour flexibility	Fixed colour
Input	Driver required (24V)
LED lifetime	30,000h
SDCM	5SDCM

INSTALLATION INFORMATION

Bathroom zone	0
Construction material	Flexible tape
Weight	330g per meter
Maximum ambient temperature	40°C
SELV	N/A (refer to LED DRIVERS section below)
Electric class (1, 2, 3)	3

PHOTOMETRICS @ 25°C

Product code	LED/m	Colour	Beam angle	CRI	lm	lm/W	lx at 1m
LSV8465050	60 LEDs/m	6500K	100°	>80Ra	1050	73	341
LSV8440050	60 LEDs/m	4000K	100°	>80Ra	1100	76	357
LSV8430050	60 LEDs/m	3000K	100°	>80Ra	1000	69	325
LSV8427050	60 LEDs/m	2700K	100°	>80Ra	950	66	309

WIRING INFORMATION

Cable / flying lead	Supplied with a minimum of 200mm flying lead from one end
Type of wiring required	Parallel

LED DRIVERS

Product code	Input	SELV	Dimming	Bathroom zone	Min	Max
PS3024B	220V-240V	Yes	Yes (PDCINT1-10V)	-	-	3m
PSDIP10024	220V-240V	Yes	Yes	-	-	5m
PSIP24024	220V-240V	Yes	Yes	-	-	3 x 5m

See page 406 for complete offer

ACCESSORIES

PDC/GRID DIMMER	Grid dimmer kit for multiple fitting types	Sold separately	422
PDCINT1-10V	1-10V dimming interface for use with 24V LED drivers	Sold separately	412

LED strip.



LSV86

Constant voltage, IP68, self-adhesive 5m LED strip

FEATURES

Wattage	19.2W per metre
IP rating	IP68
Self-adhesive backing	Yes
Colour flexibility	Fixed colour
Input	Driver required (24V)
LED lifetime	30,000h
SDCM	5SDCM

INSTALLATION INFORMATION

Bathroom zone	0
Construction material	Flexible tape
Weight	312g per meter
Maximum ambient temperature	40°C
SELV	N/A (refer to LED DRIVERS section below)
Electric class (1, 2, 3)	3

PHOTOMETRICS @ 25°C

Product code	LED/m	Colour	Beam angle	CRI	lm	lm/W	lx at 1m
LSV8665050	120 LEDs/m	6500K	120°	>80Ra	1630	85	536
LSV8640050	120 LEDs/m	4000K	120°	>80Ra	1485	77	488
LSV8630050	120 LEDs/m	3000K	120°	>80Ra	1360	71	447
LSV8627050	120 LEDs/m	2700K	120°	>80Ra	1295	67	426

WIRING INFORMATION

Cable / flying lead	Supplied with a minimum of 200mm flying lead from one end
Type of wiring required	Parallel

LED DRIVERS

Product code	Input	SELV	Dimming	Bathroom zone	Min	Max
PSDIP6024	220V-240V	Yes	Yes (PDCINT1-10V)	-	-	3m
PSDIP10024	220V-240V	Yes	Yes	-	-	5m
PSIP24024	220V-240V	Yes	Yes	-	-	2 x 5m

See page 406 for complete offer

ACCESSORIES

PDC/GRID DIMMER	Grid dimmer kit for multiple fitting types	Sold separately	422
PDCINT1-10V	1-10V dimming interface for use with 24V LED drivers	Sold separately	412

01604 495 151
collingwoodlighting.com

@collingwoodLED

/collingwoodlighting

collingwoodled

GUARANTEE / WARRANTY

3 year extended warranty

FEATURES & BENEFITS

IP68 19.2W/m LED strip

Ideal for use outside when waterproofing is required

Can be submerged in water permanently as a complete length

Any cuts are IP65

Excellent for primary lighting

Cut points every 100mm (IP65 maximum)

Supplied in a resealable, antistatic bag to protect during transit

Not suitable for installation in chlorine or bromine environments

Beam angle: 120°

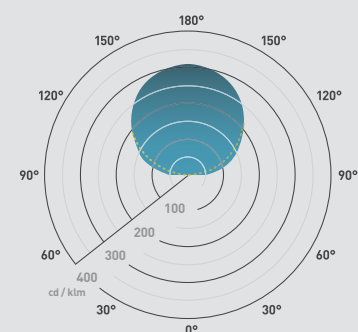

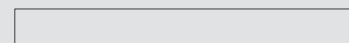

5m/100mm



11mm

LED strips.

01604 495 151
collingwoodlighting.com

-  @collingwoodLED
-  /collingwoodlighting
-  collingwoodled

GUARANTEE / WARRANTY

3 year extended warranty

FEATURES & BENEFITS

IP20 4.8W/m LED strip pack

Ideal for indoor use in a wide range of applications including task lighting

Excellent for secondary lighting

Cut points every 100mm

3M self-adhesive backing for secure and easy installation

Supplied in a resealable, antistatic bag to protect during transit

Beam angle: 120°

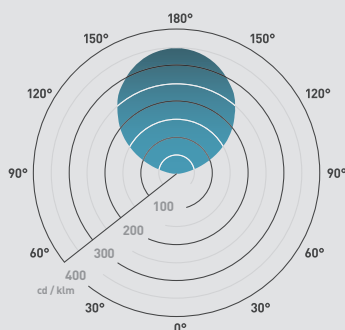

5m/100mm

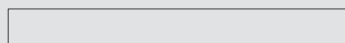

 8mm



SP50

IP20 LED strip pack and driver

FEATURES

Wattage	24W per 5m 4.8W per m
IP rating	IP20
Self-adhesive backing	Yes
Colour flexibility	Fixed colour
Input	Mains AC
LED lifetime	30,000h
SDCM	5SDCM

INSTALLATION INFORMATION

Bathroom zone	2
Construction material	Flexible tape
Weight	53g per meter
Maximum ambient temperature	40°C
SELV	Yes
Electric class [1, 2, 3]	3

PHOTOMETRICS @ 25°C

Product code	LED/m	Colour	Beam angle	CRI	lm	lm/W	lx at 1m
SP5040	60 LEDs/m	4000K	120°	>80Ra	490	102	161
SP5030	60 LEDs/m	3000K	120°	>80Ra	450	94	148
SP5027	60 LEDs/m	2700K	120°	>80Ra	430	90	141

WIRING INFORMATION

Cable / flying lead	Supplied with a minimum of 200mm flying lead from one end
Type of wiring required	Parallel

LED DRIVERS

Product code	Input	SELV	Dimming	Bathroom zone	Min	Max
PS3024B	220V-240V	Yes	Yes (PDCINT1-10V)	-	-	5m

See page 406 for complete offer



ACCESSORIES

LED STRIP PROFILE RANGE	Profile range to house adhesive strip	Sold separately	162
PDC/GRID DIMMER	Grid dimmer kit for multiple fitting types	Sold separately	422
LED COVE PACK	Coving to house adhesive strip	Sold separately	165
PDCINT1-10V	1-10V dimming interface for use with 24V LED drivers	Sold separately	412
LSBFC8 / LSBFCS8 / LSBFCD8	Range of fast fix connectors	Sold separately	166



LED strip.

01604 495 151
collingwoodlighting.com

-  @collingwoodLED
-  /collingwoodlighting
-  collingwoodled

SP54

IP44 LED strip pack and IP20 driver

FEATURES

Wattage	24W per 5m 4.8W per m
IP rating	IP44
Self-adhesive backing	Yes
Colour flexibility	Fixed colour
Input	Mains AC
LED lifetime	30,000h
SDCM	5SDCM

INSTALLATION INFORMATION

Bathroom zone	2
Construction material	Flexible tape with PU coating
Weight	80g per meter
Maximum ambient temperature	40°C
SELV	Yes
Electric class (1, 2, 3)	3

GUARANTEE / WARRANTY

3 year extended warranty

FEATURES & BENEFITS

- 4.8W/m LED strip pack
- Ideal for use in kitchens and bathrooms
- Excellent for secondary lighting
- Cut points every 100mm
- 3M self-adhesive backing for secure and easy installation
- Supplied in a resealable, antistatic bag to protect during transit

PHOTOMETRICS @ 25°C

Product code	LED/m	Colour	Beam angle	CRI	lm	lm/W	lx at 1m
SP5440	60 LEDs/m	4000K	120°	>80Ra	415	86	136
SP5430	60 LEDs/m	3000K	120°	>80Ra	385	80	127
SP5427	60 LEDs/m	2700K	120°	>80Ra	380	79	125

WIRING INFORMATION

Cable / flying lead	Supplied with a minimum of 200mm flying lead from one end
Type of wiring required	Parallel

LED DRIVERS

Product code	Input	SELV	Dimming	Bathroom zone	Min	Max
PS3024B	220V-240V	Yes	Yes (PDCINT1-10V)	-	-	5m

See page 406 for complete offer

ACCESSORIES

LED STRIP PROFILE RANGE	Profile range to house adhesive strip	Sold separately	162
PDC/GRID DIMMER	Grid dimmer kit for multiple fitting types	Sold separately	422
LED COVE PACK	Coving to house adhesive strip	Sold separately	165
PDCINT1-10V	1-10V dimming interface for use with 24V LED drivers	Sold separately	412
LSBFC8 / LSBFCS8 / LSBFCD8	Range of fast fix connectors	Sold separately	166

Beam angle: 120°

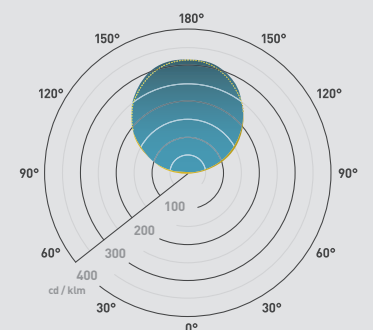

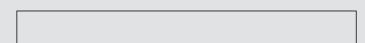

5m/100mm



8mm

LED strips.

01604 495 151
collingwoodlighting.com

 @collingwoodLED
 /collingwoodlighting
 collingwoodled

GUARANTEE / WARRANTY

3 year extended warranty

FEATURES & BENEFITS

IP44 14.4W/m LED strip pack
Ideal for use in kitchens and bathrooms
Excellent primary lighting and within coving
Cut points every 100mm
3M self-adhesive backing for secure and easy installation
Supplied in a resealable, antistatic bag to protect during transit

Beam angle: 100°

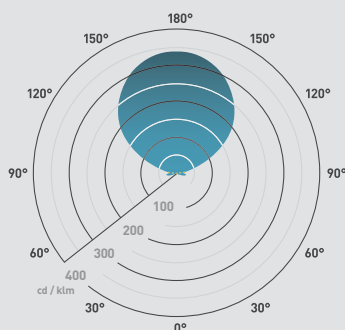

5m/100mm

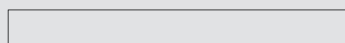

 10mm



SP154

IP44 LED strip pack and IP20 driver

FEATURES

Wattage	72W per 5m 14.4W per m
IP rating	IP44
Self-adhesive backing	Yes
Colour flexibility	Fixed colour
Input	Mains AC
LED lifetime	30,000h
SDCM	5SDCM

INSTALLATION INFORMATION

Bathroom zone	2
Construction material	Flexible tape with PU coating
Weight	196g per meter
Maximum ambient temperature	40°C
SELV	Yes
Electric class (1, 2, 3)	3

PHOTOMETRICS @ 25°C

Product code	LED/m	Colour	Beam angle	CRI	lm	lm/W	lx at 1m
SP15440	60 LEDs/m	4000K	100°	>80Ra	1200	83	411
SP15430	60 LEDs/m	3000K	100°	>80Ra	1050	73	360
SP15427	60 LEDs/m	2700K	100°	>80Ra	875	61	300

WIRING INFORMATION

Cable / flying lead	Supplied with a minimum of 200mm flying lead from one end
Type of wiring required	Parallel

LED DRIVERS

Product code	Input	SELV	Dimming	Bathroom zone	Min	Max
PS7524	220V-240V	Yes	Yes (PDCINT1-10V)	-	-	5m



See page 406 for complete offer

ACCESSORIES

LED STRIP PROFILE RANGE	Profile range to house adhesive strip	Sold separately	162
PDC/GRID DIMMER	Grid dimmer kit for multiple fitting types	Sold separately	422
LED COVE PACK	Coving to house adhesive strip	Sold separately	165
PDCINT1-10V	1-10V dimming interface for use with 24V LED drivers	Sold separately	412

LED strip.

01604 495 151
collingwoodlighting.com

-  @collingwoodLED
-  /collingwoodlighting
-  collingwoodled

GUARANTEE / WARRANTY

3 year extended warranty

FEATURES & BENEFITS

- Cut point every 100mm
- 250mm flying leads attached (reel)
- High quality LED strip using current regulation
- Next generation strip. Long lengths (up to 20m) suffer no light loss
- Foil backed flexible PCB dissipates heat (improves LED life and colour stability)
- 3M self-adhesive backing
- Supplied in customised lengths (0.1m up to 19.9m in 0.1m increments)
- NB: Cutting to required length will render this product non-returnable

Beam angle: 150°

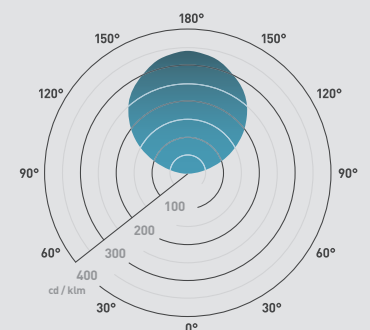

20m/5m/100mm

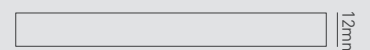

LSC03

Current regulated, self-adhesive, flexible strip

FEATURES

Wattage	4.8W per metre
IP rating	IP20
Self-adhesive backing	Yes
Bespoke lengths	Yes, call 01604 495 151 for more information
Colour flexibility	Fixed colour
Input	Driver required (24V)
LED lifetime	70,000h
SDCM	3SDCM

INSTALLATION INFORMATION

Bathroom zone	N/A
Construction material	Flexible tape
Weight	50g per meter
Maximum ambient temperature	35°C
SELV	N/A (refer to LED DRIVERS section below)
Electric class (1, 2, 3)	3

PHOTOMETRICS @ 25°C

Product code	LED/m	Colour	Beam angle	CRI	lm	lm/W	lx at 1m
LSC0340050	50 LEDs/m	4000K	150°	>80Ra	350	73	85
LSC0330050	50 LEDs/m	3000K	150°	>80Ra	350	73	85
LSC0327050	50 LEDs/m	2700K	150°	>80Ra	350	73	85

WIRING INFORMATION

Cable / flying lead	150mm flying lead with fast fix connector (LSFCS12) supplied on bespoke strip (Bespoke lengths up to 5m are available on request at extra charge)
Type of wiring required	Parallel

LED DRIVERS

Product code	Input	SELV	Dimming	Bathroom zone	Min	Max
PS1524	220V-240V	Yes	Yes (PDCINT1-10V)	-	-	3m
PS5024	220V-240V	Yes	Yes (PDCINT1-10V)	-	-	10m
PSDIP10024	220V-240V	Yes	Yes	-	-	20m



See page 406 for complete offer

ACCESSORIES

LSFC12 / LSFCS12 / LSFCD12	Range of fast fix connectors for use with LSC03	Sold separately	166
LED STRIP PROFILE RANGE	Profile range to house adhesive strip	Sold separately	162
LED COVE PACK	Coving to house adhesive strip	Sold separately	165
PDCINT1-10V	1-10V dimming interface for use with 24V LED drivers	Sold separately	412

LED strips.

01604 495 151
collingwoodlighting.com

 @collingwoodLED
 /collingwoodlighting
 collingwoodled

GUARANTEE / WARRANTY

3 year extended warranty

FEATURES & BENEFITS

Hard-wearing clear splashproof covering

High quality LED strip using current regulation

Next generation strip. Long lengths suffer no light loss

Cut point every 100mm

250mm fly leads attached

Foil backed flexible PCB dissipates heat (improves LED life and colour stability)

3M self-adhesive backing

Supplied in customised lengths (0.1m up to 4.9m in 0.1m increments)

Bespoke lengths are sealed with heat shrink for complete IP44 connections

NB: Cutting to required length will render this product non-returnable

Beam angle: 150°

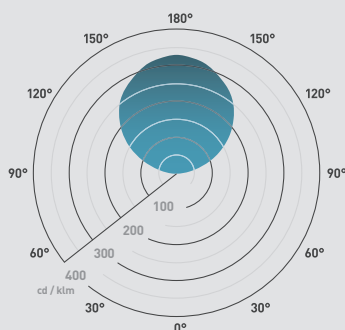

5m/100mm

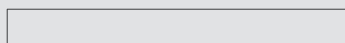

 12mm



LSC43

Current regulated, self-adhesive, flexible splash-proof strip

FEATURES

Wattage	4.8W per metre
IP rating	IP44
Self-adhesive backing	Yes
Bespoke lengths	Yes, call 01604 495 151 for more information
Colour flexibility	Fixed colour
Input	Driver required (24V)
LED lifetime	70,000h
SDCM	3SDCM

INSTALLATION INFORMATION

Bathroom zone	2
Construction material	Flexible tape
Weight	10g per meter
Maximum ambient temperature	40°C
SELV	N/A (refer to LED DRIVERS section below)
Electric class (1, 2, 3)	3

PHOTOMETRICS @ 25°C

Product code	LED/m	Colour	Beam angle	CRI	lm	lm/W	lx at 1m
LSC4340050	50 LEDs/m	4000K	150°	>80Ra	350	73	85
LSC4330050	50 LEDs/m	3000K	150°	>80Ra	350	73	85
LSC4327050	50 LEDs/m	2700K	150°	>80Ra	350	73	85

WIRING INFORMATION

Cable / flying lead	0.25m (bespoke lengths up to 5m are available on request at an extra charge)
Type of wiring required	Parallel

LED DRIVERS

Product code	Input	SELV	Dimming	Bathroom zone	Min	Max
PS1524	220V-240V	Yes	Yes (PDCINT1-10V)	-	-	3m
PS5024	220V-240V	Yes	Yes (PDCINT1-10V)	-	-	10m
PSDIP10024	220V-240V	Yes	Yes	-	-	20m

See page 406 for complete offer

ACCESSORIES

LED STRIP PROFILE RANGE	Profile range to house adhesive strip	Sold separately	162
PDC/GRID DIMMER	Grid dimmer kit for multiple fitting types	Sold separately	422

LED strip.



LSC45

Current regulated, self-adhesive, flexible splash-proof strip

FEATURES

Wattage	14.4W per metre
IP rating	IP44
Self-adhesive backing	Yes
Bespoke lengths	Yes, call 01604 495 151 for more information
Colour flexibility	Fixed colour
Input	Driver required (24V)
LED lifetime	70,000h
SDCM	3SDCM

INSTALLATION INFORMATION

Bathroom zone	2
Construction material	Flexible tape
Weight	50g per meter
Maximum ambient temperature	40°C
SELV	N/A (refer to LED DRIVERS section below)
Electric class (1, 2, 3)	3

PHOTOMETRICS @ 25°C

Product code	LED/m	Colour	Beam angle	CRI	lm	lm/W	lx at 1m
LSC4540050	50 LEDs/m	4000K	150°	>85Ra	1040	72	290
LSC4530050	50 LEDs/m	3000K	150°	>85Ra	1000	69	280
LSC4527050	50 LEDs/m	2700K	150°	>85Ra	1010	70	290

WIRING INFORMATION

Cable / flying lead	0.25m (bespoke lengths up to 5m are available on request at an extra charge)
Type of wiring required	Parallel

LED DRIVERS

Product code	Input	SELV	Dimming	Bathroom zone	Min	Max
PS5024	220V-240V	Yes	Yes (PDCINT1-10V)	-	-	3m
PSDIP10024	220V-240V	Yes	Yes	-	-	5m
PSIP24024	220V-240V	Yes	Yes (PDCINT1-10V)	-	-	3x5m

See page 406 for complete offer

ACCESSORIES

LED STRIP PROFILE RANGE	Profile range to house adhesive strip	Sold separately	162
PDC/GRID DIMMER	Grid dimmer kit for multiple fitting types	Sold separately	422

01604 495 151
collingwoodlighting.com

@collingwoodLED

/collingwoodlighting

collingwoodled

GUARANTEE / WARRANTY

3 year extended warranty

FEATURES & BENEFITS

Hard-wearing clear splashproof covering

High output LED strip using next generation current regulation technology

Long lengths suffer no light loss

Cut point every 100mm

Bespoke lengths are sealed with heat shrink for complete IP44 connections

Foil backed flexible PCB dissipates heat (improves LED life and colour stability)

3M self-adhesive backing

Supplied in customised lengths (0.1m up to 4.9m in 0.1m increments)

NB: Cutting to required length will render this product non-returnable

Beam angle: 150°

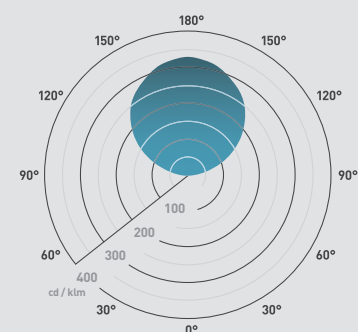

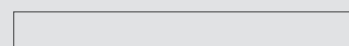

5m (cut point every 100mm)



12mm

LED strips.

01604 495 151
collingwoodlighting.com

 @collingwoodLED
 /collingwoodlighting
 collingwoodled

GUARANTEE / WARRANTY

3 year extended warranty

FEATURES & BENEFITS

Hard-wearing clear waterproof covering
Available in 5m lengths (Join up to 10m with no light loss)
Also supplied in customised lengths (0.1m up to 9.9m in 0.1m increments)
IP68 up to 1.5m
Complete with fixing clips
Not suitable for installation in chlorine or bromine environments

Beam angle: 120°

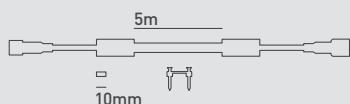
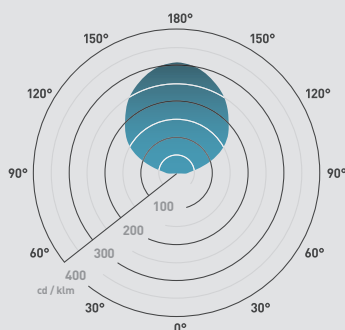

LSC83

Current regulated IP68 waterproof strip

FEATURES

Wattage	4.8W per metre
IP rating	IP68
Self-adhesive backing	Yes
Bespoke lengths	Yes, call 01604 495 151 for more information
Colour flexibility	Fixed colour
Input	Driver required (24V)
LED lifetime	70,000h
SDCM	3SDCM

INSTALLATION INFORMATION

Bathroom zone	0
Construction material	Flexible tape with PU coating
Weight	250g per meter
Maximum ambient temperature	35°C
SELV	N/A (refer to LED DRIVERS section below)
Electric class (1, 2, 3)	3

PHOTOMETRICS @ 25°C

Product code	LED/m	Colour	Beam angle	CRI	lm	lm/W	lx at 1m
LSC8340050	50 LEDs/m	4000K	120°	>85Ra	400	85	137
LSC8330050	50 LEDs/m	3000K	120°	>85Ra	360	76	123
LSC8327050	50 LEDs/m	2700K	120°	>85Ra	350	74	120

WIRING INFORMATION

Cable / flying lead	0.25m (bespoke lengths up to 5m are available on request at an extra charge)
Type of wiring required	Parallel

LED DRIVERS

Product code	Input	SELV	Dimming	Bathroom zone	Min	Max
PS1524	220V-240V	Yes	Yes (PDCINT1-10V)	-	-	3m
PS5024	220V-240V	Yes	Yes (PDCINT1-10V)	-	-	10m
PSDIP10024	220V-240V	Yes	Yes	-	-	20m

See page 406 for complete offer

ACCESSORIES

PDC/GRID DIMMER	Grid dimmer kit for multiple fitting types	Sold separately	422
PDCINT1-10V	1-10V dimming interface for use with 24V LED drivers	Sold separately	412
LSC8PWL	1.8m cable, male IP68 (submersible to 1.5m) connector & end terminal	Sold separately	167
LSC8EXT	1m IP68 (submersible to 1.5m) extension lead with male/female connectors	Sold separately	167
JB6	Inline gel filled cable connector IP68 (submersible to 1.3m)	Sold separately	423

LED strip.

01604 495 151
collingwoodlighting.com

 @collingwoodLED

 /collingwoodlighting

 collingwoodled

GUARANTEE / WARRANTY

1 year extended warranty

FEATURES & BENEFITS

Cut point every 167mm

Range of wall & floor profiles available

Suitable for indoor & outdoor use

Use with LINE PROFILE 20MM 1M to fix in place

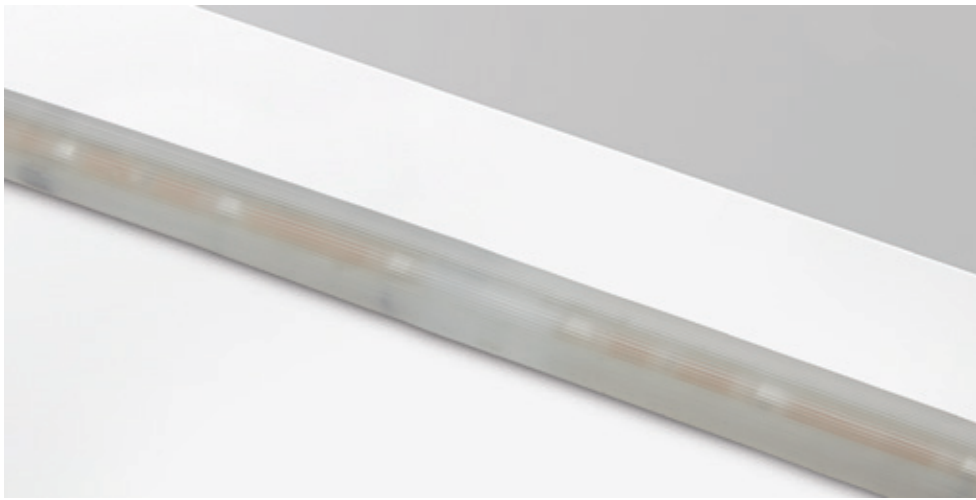

LEDSTRIP IP

Flexible waterproof LED strip

FEATURES

Wattage	2.9W per metre
IP rating	IP66
Self-adhesive backing	Yes
Colour flexibility	Fixed colour
Input	Driver required (24V)
LED lifetime	70,000h
SDCM	3SDCM

INSTALLATION INFORMATION

Bathroom zone	1
Construction material	Plastic
Weight	100g per meter
Maximum ambient temperature	35°C
SELV	N/A (refer to LED DRIVERS section below)
Electric class (1, 2, 3)	3

PHOTOMETRICS @ 25°C

Product code	Colour	Beam angle	CRI	lm	lm/W	lx at 1m
LEDSTRIP IP NW	4000K	130°	>70Ra	224	77	35
LEDSTRIP IP WW	3000K	130°	>60Ra	207	71	28
LEDSTRIP IP AMB	Amber	130°	-	-	-	-
LEDSTRIP IP BL	Blue	130°	-	-	-	-
LEDSTRIP IP RED	Red	130°	-	-	-	-

WIRING INFORMATION

Type of wiring required	Parallel
-------------------------	----------

LED DRIVERS

Product code	Input	SELV	Dimming	Bathroom zone	Min	Max
PS3024B	220V-240V	Yes	Yes (PDCINT1-10V)	1	1m	5m
PS5024	220V-240V	Yes	Yes (PDCINT1-10V)	1	-	17m
PSDIP10024	220V-240V	Yes	Yes (1-10V)	1	-	34m

See page 406 for complete offer

ACCESSORIES

CONNECTOR 6X12 / 5M	450mm/5m IP rated connector set for LEDSTRIP IP	Sold separately	167
CON EXT M/F 6X12	Extension lead for LEDSTRIP IP	Sold separately	167
CONNECTOR L, T, X 6X12	Connectors for LEDSTRIP IP	Sold separately	167
PDCINT1-10V	1-10V dimming interface for use with 24V LED drivers	Sold separately	412
LED STRIP PROFILES	Profile range to house LEDSTRIP IP	Sold separately	164

Beam angle: 130°

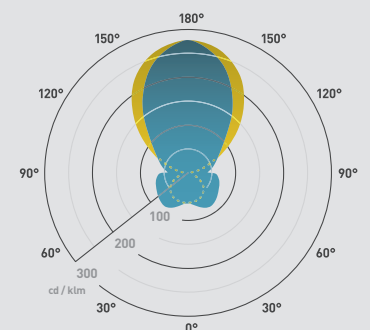

167mm (cut point)

12mm

Residential floodlights.

Popular for illuminating environments with bright washes of light, floodlights are becoming an indispensable element of security in today's society. Our 10W and 20W floodlights offer a crisp, flicker-free light to compliment any CCTV recordings and ensuring a perfect image when played back, providing reassurance and peace of mind.

Not only this, the circular bracket provides full 360° orientation of the light - even after installation - allowing for incredible illumination for every requirement. Should the installation requirements change in the future, the 360° control means the process is as simple as rotating the product in the desired direction. Colour switchable technology is also present with a convenient IP65 rated toggle switch, located on the back of the product. This can also be used after installation to aid you in choosing the right colour temperature for the environment.



Residential floodlights.

Functional and security lighting

Floodlights add security and illumination to outdoor areas of a home, outbuildings and business premises. LED floodlights are cost effective to run and can provide high intensity lighting to any space.

PIR - passive infrared sensor

PIR sensors utilise infrared technology to detect motion in the surrounding area, only activating when required. These are a great option for adding safety and security to outside spaces such as parking areas, driveways and entrances.

How does it work

PIR sensors detect changes in heat within the surrounding space.

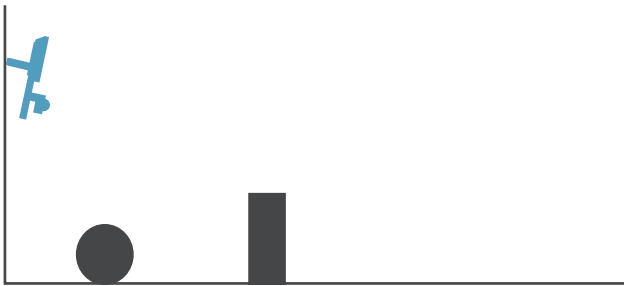

When a new object enters the area the infrared energy levels change rapidly, this trips the sensor and turns on the light.

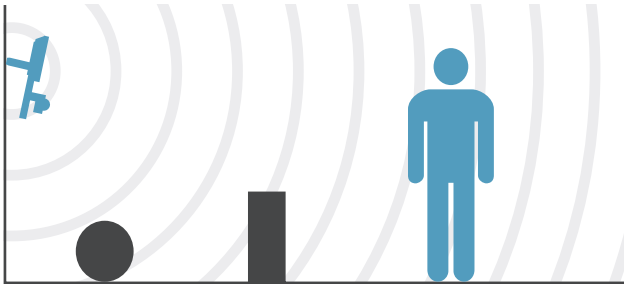

Directional sensor

Our floodlight PIR sensors are fully adjustable, allowing the option to point and trip the sensor in one direction and illuminate another.

In an ideal situation, this would be practised in areas such as alley ways, whereby the floodlight will light if the sensor is triggered as a person approaches the walkway.



PIR override

In some instances, there may be a requirement for the floodlight to remain permanently on or off, eliminating the need for the PIR sensor on a temporary basis.

With the PIR override our floodlights have the ability to cater for a multitude of requirements, allowing for flexible and easy use.

To disable the PIR sensor, switch the floodlight off and on within two seconds. In this mode, the floodlight will remain illuminated until the PIR is activated again. To reactivate the PIR sensor, switch the floodlight off for 10 seconds. When turned back on again, the floodlight will return to PIR mode.

Colour switchable

We've designed this light with three colour temperatures which can be changed using an IP65 switch on the back.

3000K



4000K



6500K



High efficacy

With 118lm/W, we're proud to offer our floodlights as the most energy efficient we've ever produced.

Not only does this provide a cost saving over time, but is also hugely beneficial with regards to environmental welfare.



Flicker-free

The two benefits of a flicker-free light are:

Visual comfort

Flickering lights can create uncomfortable environments and health problems such as migraines, so flicker-free alternatives make for a more comfortable setting.

Security

Flickering floodlights disrupt the quality of CCTV images. However, using flicker-free alongside cameras will ensure a perfect, crisp image.

Adjustable bracket

With an adjustable bracket, our product can be positioned in any direction.

Flexibility and reliability

Combining 360° rotation and 180° tilt, this light can be pointed in any direction, ensuring you can illuminate a space from any position.

360° rotation

The product has a circular bracket at the end which allows it to be rotated in any direction. Once installed onto a wall, the light can be pointed in any direction with ease.

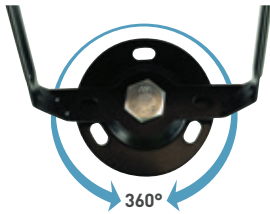

180° tiltable

The bracket directly attached to the floodlight allows the product to tilt both upwards and downwards.



Easy installation

The circular bracket is detachable and can be mounted to the surface before the rest of the product, allowing for a remarkably easy installation. The product is then simply attached onto the bracket with screws and installation is completed.

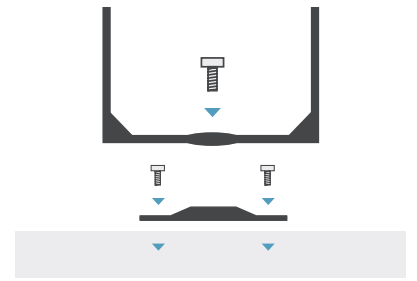

Product comparison

Using the diagram below, determine which size product and output is suitable for your installation.

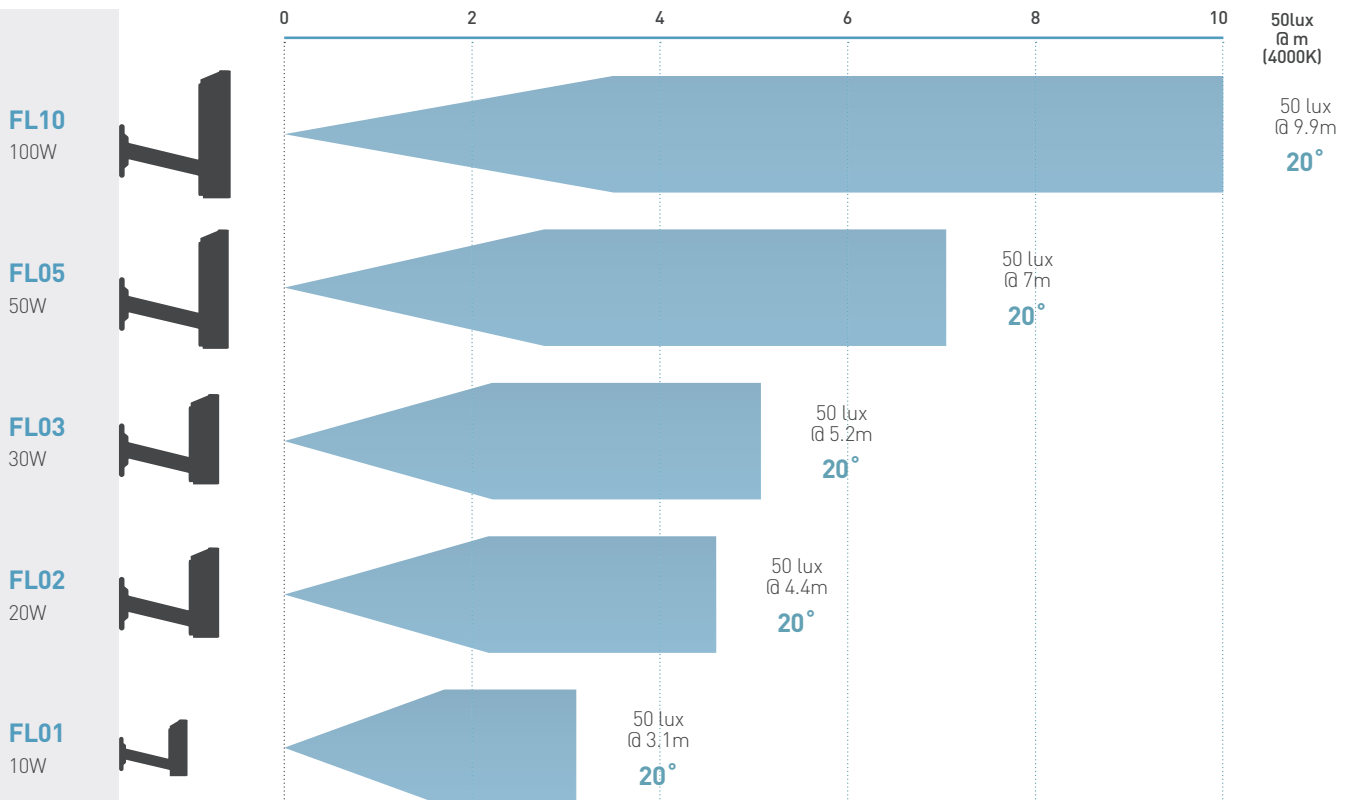

Residential floodlights.

01604 495 151
collingwoodlighting.com

 @collingwoodLED

 /collingwoodlighting

 collingwoodled

GUARANTEE / WARRANTY

3 year extended warranty

FEATURES & BENEFITS

Colour switchable

IP44 (PIR version)

115lm/W

180° tilt

360° rotation - complete adjustability

Supplied with 1m cable

25,000 hours L70 / B50

Flicker free

Wide 120° beam angle, reducing the number of fittings per area required

PIR override

Beam angle: C0/C180 C90/C270

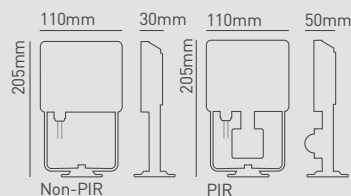
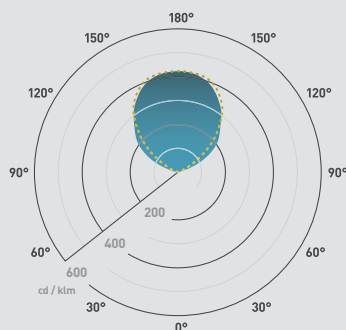

FL01

10W colour switchable floodlight

FEATURES

Wattage	10W
IP rating	IP65
IK rating	IK07
Colour flexibility	Colour switchable
Tiltable	180°
Rotatable	360°
UGR	UGR 14
Dimmable	No
Input	Mains AC
LED lifetime	25,000h
SDCM	5SDCM
Flicker free	Yes

INSTALLATION INFORMATION

Inrush current	10A 0.262ms
Construction material	Black painted cast aluminium
Weight	440g
Maximum ambient temperature	40°C
Electric class (1, 2, 3)	1

PHOTOMETRICS @ 25°C

Product code	Finish	Sensor	Colour	Beam angle	CRI	lm	lm/W	lx at 1m
FL01BXCS	Black	Non PIR sensor	6500K	120°	>80Ra	1100	110	463
			4000K	120°	>80Ra	1150	115	484
			3000K	120°	>80Ra	1000	100	421
FL01BPCS	Black	PIR sensor	6500K	120°	>80Ra	1100	110	463
			4000K	120°	>80Ra	1150	115	484
			3000K	120°	>80Ra	1000	100	421

WIRING INFORMATION

Cable / flying lead	1m H05RN-F rubberised cable 3x1.0mm ² Ø7mm
Type of wiring required	Parallel

ACCESSORIES

N/A	No accessories required
-----	-------------------------

Residential floodlights.

01604 495 151
collingwoodlighting.com

 @collingwoodLED

 /collingwoodlighting

 collingwoodled

GUARANTEE / WARRANTY

3 year extended warranty

FEATURES & BENEFITS

Colour switchable
IP44 (PIR version)
115lm/W
180° tilt
360° rotation - complete adjustability
Supplied with 1m cable
25,000 hours L70 / B50
Flicker free
Wide 120° beam angle, reducing the number of fittings per area required
PIR override

Beam angle: C0/C180 C90/C270

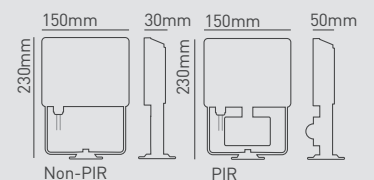
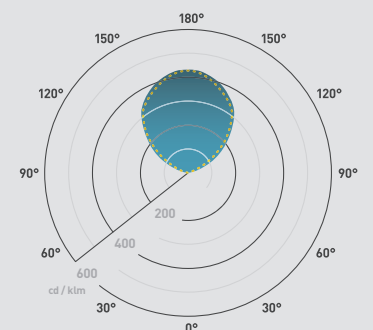

FL02

20W colour switchable floodlight

FEATURES

Wattage	20W
IP rating	IP65
IK rating	IK07
Colour flexibility	Colour switchable
Tilttable	180°
Rotatable	360°
UGR	UGR 14
Dimmable	No
Input	Mains AC
LED lifetime	25,000h
SDCM	5SDCM
Flicker free	Yes

INSTALLATION INFORMATION

Inrush current	11A 0.474ms
Construction material	Black painted cast aluminium
Weight	580g
Maximum ambient temperature	40°C
Electric class (1, 2, 3)	1

PHOTOMETRICS @ 25°C

Product code	Finish	Sensor	Colour	Beam angle	CRI	lm	lm/W	lx at 1m
FL02BXCS	Black	Non PIR sensor	6500K	120°	>80Ra	2200	110	943
			4000K	120°	>80Ra	2300	115	986
			3000K	120°	>80Ra	2000	100	858
FL02BPCS	Black	PIR sensor	6500K	120°	>80Ra	2200	110	943
			4000K	120°	>80Ra	2300	115	986
			3000K	120°	>80Ra	2000	100	858

WIRING INFORMATION



Cable / flying lead	1m H05RN-F rubberised cable 3x1.0mm ² Ø7mm
Type of wiring required	Parallel

ACCESSORIES

N/A	No accessories required
-----	-------------------------

Residential floodlights.

01604 495 151
collingwoodlighting.com

 @collingwoodLED
 /collingwoodlighting
 collingwoodled

GUARANTEE / WARRANTY

3 year extended warranty

FEATURES & BENEFITS

Colour switchable
IP65 (non-PIR version)
107lm/W
180° tilt
360° rotation - complete adjustability
Supplied with 1m cable
25,000 hours L70 / B50
Flicker free
Wide 120° beam angle, reducing the number of fittings per area required

Beam angle: C0/C180 C90/C270

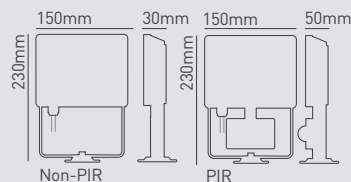
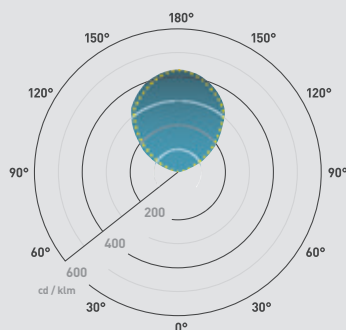

FL03

30W colour switchable floodlight

FEATURES

Wattage	30W
IP rating	IP65
IK rating	IK07
Colour flexibility	Colour switchable
Tilttable	180°
Rotatable	360°
UGR	UGR 14
Dimmable	No
Input	Mains AC
LED lifetime	25,000h
SDCM	5SDCM

INSTALLATION INFORMATION

Inrush current	30A 0.004ms
Construction material	Black painted cast aluminium
Weight	590g
Maximum ambient temperature	40°C
Electric class (1, 2, 3)	1

PHOTOMETRICS @ 25°C

Product code	Finish	Sensor	Colour	Beam angle	CRI	lm	lm/W	lx at 1m
FL03BXCS	Black	Non PIR sensor	6500K	120°	>80Ra	3000	100	1280
			4000K	120°	>80Ra	3200	107	1366
			3000K	120°	>80Ra	2800	93	1195
FL03BPCS	Black	PIR sensor	6500K	120°	>80Ra	3000	100	1280
			4000K	120°	>80Ra	3200	107	1366
			3000K	120°	>80Ra	2800	93	1195

WIRING INFORMATION

Cable / flying lead	1m H05RN-F rubberised cable 3x1.0mm² Ø7mm
Type of wiring required	Parallel

ACCESSORIES

N/A	No accessories required
-----	-------------------------

Residential floodlights.

01604 495 151
collingwoodlighting.com

 @collingwoodLED

 /collingwoodlighting

 collingwoodled

GUARANTEE / WARRANTY

3 year extended warranty

FEATURES & BENEFITS

Colour switchable
IP44 (PIR version)
112lm/W
180° tilt
360° rotation - complete adjustability
Supplied with 1m cable
25,000 hours L70 / B50
Flicker free
Wide 120° beam angle, reducing the number of fittings per area required
PIR override

Beam angle: C0/C180 C90/C270

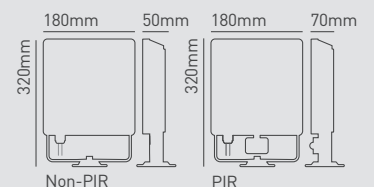
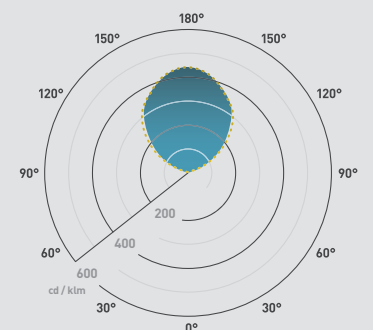

FL05

50W colour switchable floodlight

FEATURES

Wattage	50W
IP rating	IP65
IK rating	IK07
Colour flexibility	Colour switchable
Tilttable	180°
Rotatable	360°
UGR	UGR 14
Dimmable	No
Input	Mains AC
LED lifetime	25,000h
SDCM	4SDCM

INSTALLATION INFORMATION

Inrush current	28A 0.013ms
Construction material	Black painted cast aluminium
Weight	1220g
Maximum ambient temperature	40°C
Electric class (1, 2, 3)	1

PHOTOMETRICS @ 25°C

Product code	Finish	Sensor	Colour	Beam angle	CRI	lm	lm/W	lx at 1m
FL05BXCS	Black	Non PIR sensor	6500K	120°	>80Ra	5100	102	2230
			4000K	120°	>80Ra	5600	112	2449
			3000K	120°	>80Ra	5000	100	2230
FL05BPCS	Black	PIR sensor	6500K	120°	>80Ra	5100	102	2230
			4000K	120°	>80Ra	5600	112	2449
			3000K	120°	>80Ra	5000	100	2230

WIRING INFORMATION



Cable / flying lead	1m H05RN-F rubberised cable 3x1.0mm² Ø7mm
Type of wiring required	Parallel

ACCESSORIES

N/A	No accessories required
-----	-------------------------

Residential floodlights.

01604 495 151
collingwoodlighting.com

 @collingwoodLED
 /collingwoodlighting
 collingwoodled

GUARANTEE / WARRANTY

3 year extended warranty

FEATURES & BENEFITS

Colour switchable
IP65
118lm/W
180° tilt
360° rotation - complete adjustability
Supplied with 1m cable
25,000 hours L70 / B50
Flicker free
Wide 120° beam angle, reducing the number of fittings per area required

Beam angle: **C0/C180** **C90/C270**

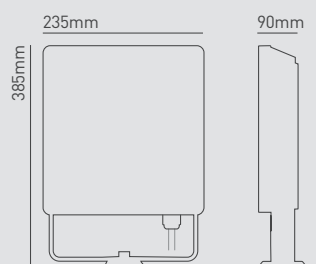
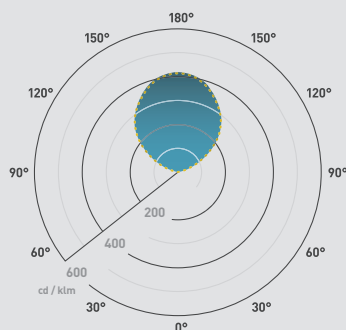

FL10

100W colour switchable floodlight

FEATURES

Wattage	100W
IP rating	IP65
IK rating	IK07
Colour flexibility	Colour switchable
Tilttable	180°
Rotatable	360°
UGR	UGR 14
Dimmable	No
Input	Mains AC
LED lifetime	25,000h
SDCM	4SDCM

INSTALLATION INFORMATION

Inrush current	75A 0.005ms
Construction material	Black painted cast aluminium
Weight	2100g
Maximum ambient temperature	40°C
Electric class (1, 2, 3)	1

PHOTOMETRICS @ 25°C

Product code	Finish	Sensor	Colour	Beam angle	CRI	lm	lm/W	lx at 1m
FL10BXCS	Black	Non PIR sensor	6500K	120°	>80Ra	10970	110	4575
			4000K	120°	>80Ra	11810	118	4926
			3000K	120°	>80Ra	10250	103	4275

WIRING INFORMATION

Cable / flying lead	1m H05RN-F rubberised cable 3x1.0mm ² Ø7mm
Type of wiring required	Parallel

ACCESSORIES

N/A	No accessories required
-----	-------------------------

Residential floodlights.

01604 495 151
collingwoodlighting.com

 @collingwoodLED

 /collingwoodlighting

 collingwoodled

GUARANTEE / WARRANTY

7 year extended warranty

FEATURES & BENEFITS

Neat and compact, straight to the mains linear floodlight

Complete with wall fixings

Mains waterproof connector included

Max. 3 on 500W mains dimmer
Max. 5 on 1000W mains dimmer

Compatible with many leading lighting control systems



FL200

Dimmable linear LED floodlight

FEATURES

Wattage	21W
IP rating	IP65
Colour flexibility	Fixed colour
Tilttable	180°
Rotatable	360°
Dimmable	Yes
Input	Mains AC
LED lifetime	70,000h L70 B10
SDCM	3SDCM
Flicker free	Yes

INSTALLATION INFORMATION

Inrush current	15A 0.5ms
Construction material	Anodised aluminium (body) stainless steel 316 (bracket)
Weight	1300g
Maximum ambient temperature	35°C
Electric class (1, 2, 3)	1

PHOTOMETRICS @ 25°C

Product code	Colour	Beam angle	CRI	lm	lm/W	lx at 1m
FL200FNW	4000K	50°	>80Ra	1830	87	4366
FL200FWW	3000K	50°	>80Ra	1690	80	4032
FL200F27	2700K	50°	>80Ra	1650	79	3936

WIRING INFORMATION

Cable / flying lead	N/A (IP65 waterproof connector)
Type of wiring required	Parallel

ACCESSORIES

Dimming options	Call us on 01604 495151 for more information
-----------------	--

Beam angle: 50°

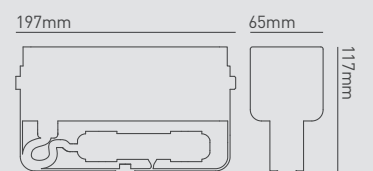
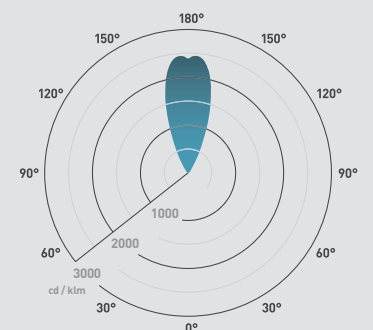

Landscape.

Lighting has the potential to dramatically enhance the overall design of any landscape, and should be considered at the start of every design. Providing an abundance of benefits for both residential and commercial spaces, landscape lighting can add safety, security, ambiance, mood and drama to the overall environment. Limited only by the designer's imagination, the practical functions and various mood effects that can be established are endless. Our range of ground lights are built to last and can be used in many environments, even coastal areas with our marine grade stainless steel 316 products, providing you with the reassurance that the products will look as good as the day they were fitted.

In addition to ground lights the use of wall and spike lights in any design will amplify the overall look and feel. Available in contemporary finishes such as anodised bronze and copper, they are sure to add depth and edge to any design. Charismatic and timeless, finishing your overall design with our hand crafted, bespoke bollard range will ensure a safe, dynamic and elegantly lit space to compliment the surroundings.



Landscape lighting.

Adding depth to landscapes

Transforming any landscape with lighting design is as important as interior lighting. It can invigorate the environment and bring the space to life.

Incorporating lighting into landscape design

To amplify the quality of a landscape, lighting should be incorporated into the design. When it comes to landscape lighting, three areas should be considered; functional areas, feature areas and entertainment areas. If consideration is taken for these, landscapes will have added depth and can really be brought to life.

Functional areas

The correct lighting should be considered when illumination is required for a certain task, such as visibility or circulation. Pathways and storage areas usually require functional lighting but can be used as a layer of light that contributes to the overall landscape.

Feature areas

Sculptures, ponds and interesting plant life can form distinct features in a landscape design, but may be lost at night. Consider the most appropriate way to light them to ensure they become the focal point in a landscape.

Entertainment areas

Lighting in this area should be used to create ambience as it often becomes the most used area in a landscape. As such, it is a good idea to consider lighting at the start of the design. This can be further enhanced through the use of controls.



Maximising materials

Importance of colour temperature

Accentuating the materials in a landscape can be achieved by selecting a colour temperature that enhances the colour of the material being highlighted.

Wood / sand

Warmer tones found in materials such as these would be complimented by a colour temperature of 2700K - 3000K.

Stone

For featuring the natural components of stone, a colour temperature of 2700K - 4000K will be most suitable.

Whites

For white materials, such as painted brick or furniture, choose 4000K to emphasise the tones.



Layering light

Layering light in a space is key to effective lighting design and is important because it provides functionality and visual interest to every scheme. This can be done by picking key areas and ensuring dark is used as effectively as light.



Atmosphere

Correct colour temperature is paramount for the choice of material you wish to highlight and the atmosphere you wish to create. Landscape designs are easily transformed by the correct colour temperature.

Warmest

2700K

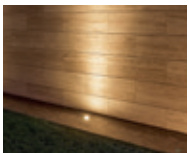

Warm

3000K

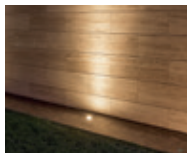

Natural white

4000K

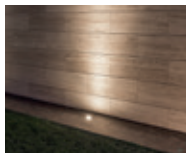

Flood vs. spot

Choose the ideal beam angle to achieve the effect that you need.

Flood

Wash light over an area with a wider beam angle.



Spot

Concentrated beam of light with a narrower beam angle.



Textured surfaces vs. flat surfaces

When choosing a light fitting, it is imperative to consider the surface that the light will be used on. At this stage, it is a great opportunity to bring the materials to life and compliment the landscape design.

Textured surface

Use a spot, close to the surface, to graze light over the surface, highlighting the texture and adding depth to the surface.



Flat surfaces

Use a flood to wash light over the surface, highlighting the clean nature of the surface/design.

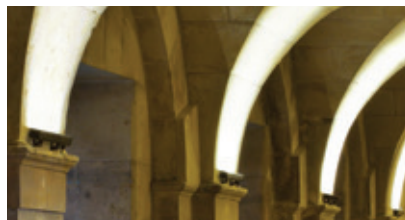

Underwater lighting

IP68 rated lights are completely air tight and can be used underwater. Patented technology, unique to Collingwood, prevents water ingress from the back of the light, where the cable enters the product.

When designing a pond area, ensure that you are using IP68 rated products.



Ground lights.

Highlighting features inside and out

Using ground lights in any light design can transform your space from dark and uninspiring to a perfectly illuminated space to suit any requirement.

What type of ground light?

We offer the ideal ground light for every installation.

- 1 High power ground light**
 Powerful in output and large in scale, these fittings are ideal for illuminating big trees and the facades of taller buildings.
- 2 Mid power ground light**
 Choose these to light smaller façades, trees shrubs and garden walls. These fittings can also be used inside large scale buildings to highlight architectural features.
- 3 Low power ground light**
 Ideal for uplighting domestic façades and for use on wide steps and terraces with low level planting, these fittings can also be used inside to highlight architectural features. They can also be recessed into ceilings to provide small downlight options in display cases, alcoves or in showers.
- 4 Low glare ground light**
 These fittings are ideal for use indoors or near terraces, seating areas and along pathways where people pass nearby.
- 5 Marker light**
 Providing a subtle, diffused glow of light, these fittings are ideal for steps, pathways, driveways and car parks.
- 6 Underwater lighting**
 IP rated to IP68 and tested to 9m submersion.

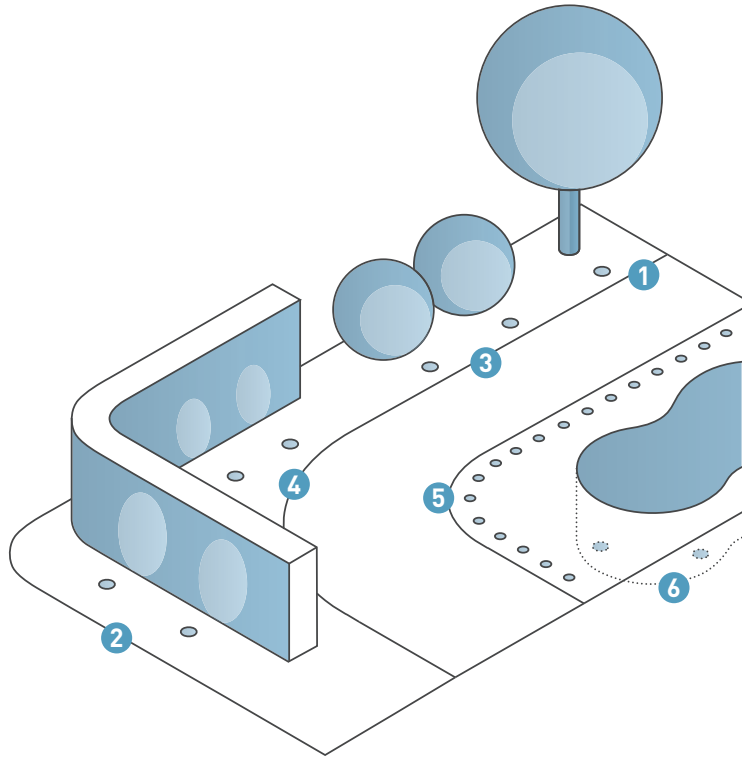

Choose the ideal size and output

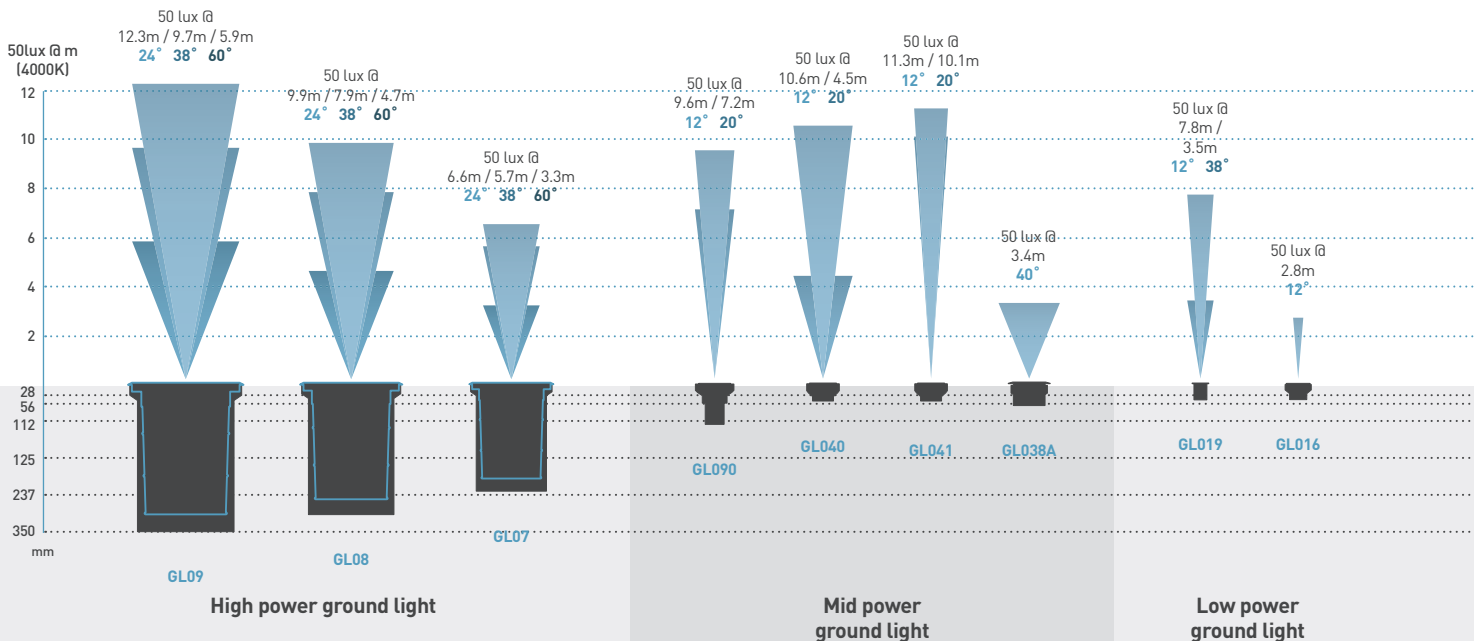

Underwater lighting

IP68 rated ground lights are completely air tight and can be used under water.

Our low voltage groundlights utilise patented technology, unique to Collingwood, which prevents water ingress from the back of the light, where the cable enters the product.



Visibility of the fitting

Low glare options are available for installations where the fitting may be situated in a high-traffic area, helping to create a comfortable environment.

We offer baffled technology and honeycomb low glare options.

Baffled (ULG)

Honeycomb (LG)



GLA01 square transformer plate

The perfect accessory to change the look of ground lights. The GLA01 is a square plate to transform round ground lights to square ground lights.

This is also a marine grade stainless steel 316.

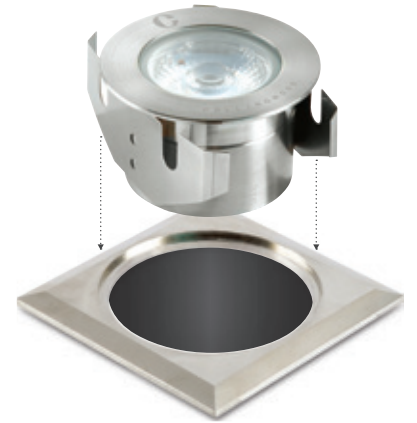

50 lux @
7.6m / 3.7m
12° 34°

50 lux @
6.8m / 1.5m
12° 30°

50 lux @
4.2m / 2.2m
12° 30°



GL040
ULG

GL019
ULG

GL019 LG



GL007
Frosted



GL050
GL051



GL019
Frosted



GL016
Frosted



GL018



GL063
GL064



GL100



GL200



Low glare

Marker lights

Multi window
marker lights

Ground lights.

01604 495 151
collingwoodlighting.com

-  @collingwoodLED
-  /collingwoodlighting
-  collingwoodled

GUARANTEE / WARRANTY

3 year extended warranty

FEATURES & BENEFITS

- Adjustable LED fittings
- Equivalent to 50W Halogen & 100W AR111
- Straight to mains
- Robust cable for outdoor use

Beam angle: 24° 38° 60°

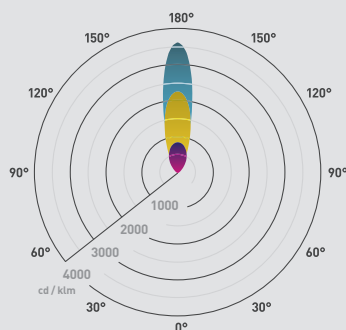

Ø300/290mm

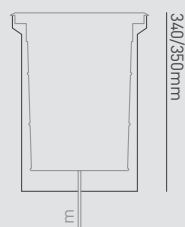

GL09

Triple LED drive over ground light

FEATURES

Wattage	25.5W
IP rating	IP67
IK rating	IK10
Colour flexibility	Fixed colour
Tilttable	20°
Walk over / drive over	Drive over (15mph maximum)
Input	Mains AC
LED lifetime	70,000h L70 B10
SDCM	3SDCM

INSTALLATION INFORMATION

Bathroom zone	2
Inrush current	2.8A 0.2ms
Construction material	Stainless steel 304 (cover ring) / Aluminium (body)
Weight	7.51Kg
Maximum ambient temperature	40°C
SELV	Yes
Electric class (1, 2, 3)	1

PHOTOMETRICS @ 25°C

Product code	Colour	Beam angle	CRI	lm	lm/W	lx at 1m
GL09D60X40	4000K	60°	>80Ra	2085	82	1742
GL09D38X40	4000K	38°	>80Ra	2085	82	4752
GL09D24X40	4000K	24°	>80Ra	2085	82	7529
GL09D60X30	3000K	60°	>80Ra	2085	82	1742
GL09D38X30	3000K	38°	>80Ra	2085	82	4752
GL09D24X30	3000K	24°	>80Ra	2085	82	7529
GL09D60X27	2700K	60°	>80Ra	2040	80	1704
GL09D38X27	2700K	38°	>80Ra	2040	80	4649
GL09D24X27	2700K	24°	>80Ra	2040	80	7367

WIRING INFORMATION

Cable / flying lead	1m H05RN-F rubberised cable (outside diameter: 7mm)
Type of wiring required	Parallel

LED DRIVERS

Product code	Input	SELV	Dimming	Bathroom zone	Min	Max
N/A (driver built in)	220-240V	-	No	2	-	-

ACCESSORIES

Installation tube	Included	236
JB5	Gel filled waterproof connector	Sold separately 423
WC 5-9	Quick waterproof connector	Sold separately 422

Ground lights.

01604 495 151
collingwoodlighting.com

 @collingwoodLED

 /collingwoodlighting

 collingwoodled

GUARANTEE / WARRANTY

3 year extended warranty

FEATURES & BENEFITS

- Adjustable LED fittings
- Equivalent to 50W Halogen & 100W AR111
- Straight to mains
- Robust cable for outdoor use
- Installation tube included
- 10mm toughened glass, ideal for use in driveways



GL08

Twin LED drive over ground light

FEATURES

Wattage	17W
IP rating	IP67
IK rating	IK10
Colour flexibility	Fixed colour
Tilttable	20°
Walk over / drive over	Drive over (15mph maximum)
Input	Mains AC
LED lifetime	70,000h L70 B10
SDCM	3SDCM

INSTALLATION INFORMATION

Bathroom zone	2
Inrush current	1.8A 0.2ms
Construction material	Stainless steel 304 (cover ring) / Aluminium (body)
Weight	4.1Kg
Maximum ambient temperature	40°C
SELV	Yes
Electric class [1, 2, 3]	1

PHOTOMETRICS @ 25°C

Product code	Colour	Beam angle	CRI	lm	lm/W	lx at 1m
GL08D60X40	4000K	60°	>80Ra	1390	82	1103
GL08D38X40	4000K	38°	>80Ra	1390	82	3146
GL08D24X40	4000K	24°	>80Ra	1390	82	4862
GL08D60X30	3000K	60°	>80Ra	1390	82	1103
GL08D38X30	3000K	38°	>80Ra	1390	82	3146
GL08D24X30	3000K	24°	>80Ra	1390	82	4862
GL08D60X27	2700K	60°	>80Ra	1360	80	1079
GL08D38X27	2700K	38°	>80Ra	1360	80	3078
GL08D24X27	2700K	24°	>80Ra	1360	80	4757

WIRING INFORMATION

Cable / flying lead	1m H05RN-F rubberised cable (outside diameter: 7mm)
Type of wiring required	Parallel

LED DRIVERS

Product code	Input	SELV	Dimming	Bathroom zone	Min	Max
N/A (driver built in)	220-240V	Yes	No	2	-	-

ACCESSORIES

Installation tube	Included	236
JB5	Gel filled waterproof connector	Sold separately 423
WC 5-9	Quick waterproof connector	Sold separately 422

Beam angle: 24° 38° 60°

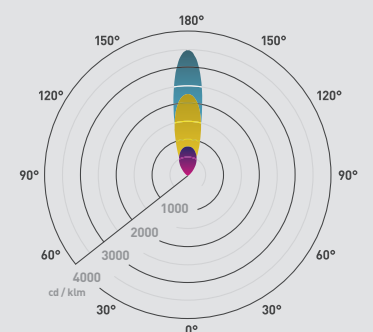

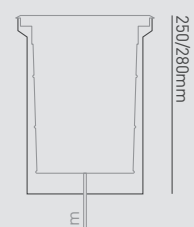

Ø225/212mm



Ground lights.

01604 495 151
collingwoodlighting.com

-  @collingwoodLED
-  /collingwoodlighting
-  collingwoodled

GUARANTEE / WARRANTY

3 year extended warranty

FEATURES & BENEFITS

- Adjustable LED fittings
- Equivalent to 50W Halogen
- Robust cable for outdoor use
- Straight to mains
- Installation tube included
- 10mm toughened glass, ideal for us in driveways

Beam angle: 24° 38° 60°

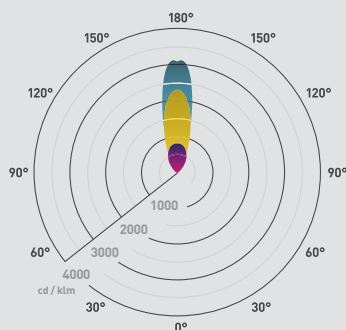

Ø185/180mm

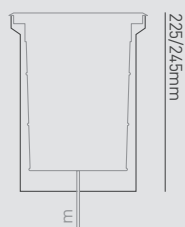

GL07

Drive over LED ground light

FEATURES

Wattage	8.5W
IP rating	IP67
IK rating	IK10
Colour flexibility	Fixed colour
Tilttable	20°
Walk over / drive over	Drive over (15mph maximum)
Input	Mains AC
LED lifetime	70,000h L70 B10
SDCM	3SDCM

INSTALLATION INFORMATION

Bathroom zone	2
Inrush current	0.92A 0.13ms
Construction material	Stainless steel 304 (cover ring) / Aluminium (body)
Weight	2.8Kg
Maximum ambient temperature	40°C
SELV	Yes
Electric class (1, 2, 3)	1

PHOTOMETRICS @ 25°C

Product code	Colour	Beam angle	CRI	lm	lm/W	lx at 1m
GL07D60X40	4000K	60°	>80Ra	695	82	550
GL07D38X40	4000K	38°	>80Ra	695	82	1620
GL07D24X40	4000K	24°	>80Ra	695	82	2198
GL07D60X30	3000K	60°	>80Ra	695	82	550
GL07D38X30	3000K	38°	>80Ra	695	82	1620
GL07D24X30	3000K	24°	>80Ra	695	82	2198
GL07D60X27	2700K	60°	>80Ra	685	81	542
GL07D38X27	2700K	38°	>80Ra	685	81	1596
GL07D24X27	2700K	24°	>80Ra	685	81	2167

WIRING INFORMATION

Cable / flying lead	1m H05RN-F rubberised cable (outside diameter: 7mm)
Type of wiring required	Parallel

LED DRIVERS



Product code	Input	SELV	Dimming	Bathroom zone	Min	Max
N/A (driver built in)	220-240V	-	No	2	-	-

ACCESSORIES

Installation tube	Included	236
JB5	Gel filled waterproof connector	Sold separately 423
WC 5-9	Quick waterproof connector	Sold separately 422

Ground lights.

01604 495 151
collingwoodlighting.com

-  @collingwoodLED
-  /collingwoodlighting
-  collingwoodled

GUARANTEE / WARRANTY

7 year extended warranty

FEATURES & BENEFITS

- Frosted effect for softer tone of light
- Straight to mains
- Installation tube included
- 10mm toughened glass, ideal for use in driveways



GL007 Frosted

Frosted LED drive over ground / marker light

FEATURES

Wattage	8W
IP rating	IP67
IK rating	IK10
Colour flexibility	Fixed colour
Walk over / drive over	Drive over (15mph maximum)
Input	Mains AC
LED lifetime	70,000h L70 B10
SDCM	3SDCM

INSTALLATION INFORMATION

Bathroom zone	2
Inrush current	10.7A 0.7ms
Construction material	Stainless steel 304 (cover ring) / Aluminium (body)
Weight	2.7Kg
Maximum ambient temperature	35°C
SELV	Yes
Electric class [1, 2, 3]	1

PHOTOMETRICS @ 25°C

Product code	Colour	Beam angle	CRI	lm	lm/W	lx at 1m
GL007 FROSTED NW	4000K	120°	>80Ra	101	13	43
GL007 FROSTED WW	3000K	120°	>80Ra	96	12	33

WIRING INFORMATION

Cable / flying lead	1m H05RN-F rubberised cable (outside diameter: 7mm)
Type of wiring required	Parallel

LED DRIVERS

Product code	Input	SELV	Dimming	Bathroom zone	Min	Max
N/A (integrated SELV driver)	220-240V	-	No	2	-	-

ACCESSORIES

Installation tube		Included	101
JB5	Gel filled waterproof connector	Sold separately	423
WC 5-9	Quick waterproof connector	Sold separately	422

Beam angle: 120°

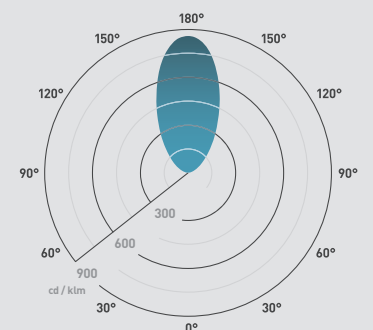

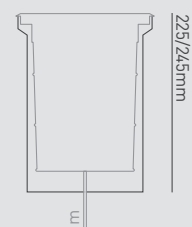

Ø185/180mm



Ground lights.

01604 495 151
collingwoodlighting.com

-  @collingwoodLED
-  /collingwoodlighting
-  collingwoodled

GUARANTEE / WARRANTY

7 year extended warranty

FEATURES & BENEFITS

Equivalent to 35W halogen & 35W AR111
Robust cable for outdoor use



GL090

7W LED ground light

FEATURES

Wattage	7W
IP rating	IP68
IK rating	IK09
Colour flexibility	Fixed colour
Walk over / drive over	Walk over (5mm toughened glass)
Input	700mA
LED lifetime	70,000h L70 B10
SDCM	3SDCM

INSTALLATION INFORMATION

Cut out size	Ø 65mm
Bathroom zone	0
Inrush current	N/A
Construction material	Stainless steel (316)
Weight	800g
Maximum ambient temperature	35°C
SELV	N/A
Electric class (1, 2, 3)	3

PHOTOMETRICS @ 25°C

Product code	Colour	Beam angle	CRI	lm	lm/W	lx at 1m
GL090 F NW	4000K	20°	>80Ra	400	57	2594
GL090 S NW	4000K	12°	>80Ra	400	57	4590
GL090 F WW	3000K	20°	>80Ra	320	46	2076
GL090 S WW	3000K	12°	>80Ra	320	46	3671
GL090 F 27	2700K	20°	>80Ra	310	44	2011
GL090 S 27	2700K	12°	>80Ra	310	44	3556
GL090 F BL	Blue	20°	-	43	6	493
GL090 S BL	Blue	12°	-	-	-	-

WIRING INFORMATION

Cable / flying lead	1m (H05RN-F) rubberised cable (outside diameter: 6mm)
Type of wiring required	Series

LED DRIVERS

Product code	Input	SELV	Dimming	Bathroom zone	Min	Max
PLU/700 3-9	220-240V	Yes	No	1	1	3
PLD UNI-DRIVE 700mA	110-240V	Yes	Yes (1-10V)	1	1	3

ACCESSORIES

JB2 / JB4 / JB6	IP68 waterproof connectors	Sold separately	422-433
TUBE/68	Installation tube	Sold separately	236
WCR 275 BLACK	2-core rubber cable	Sold separately	423
PDC/GRID DIMMER	Grid dimmer kit for multiple fitting types	Sold separately	422

Beam angle: 12° 20°

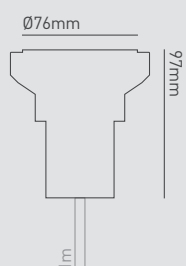
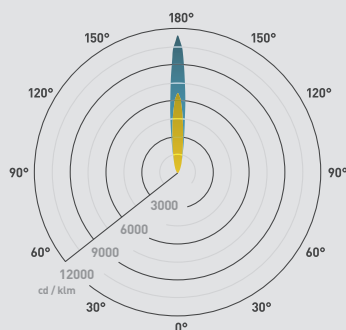

Ground lights.

01604 495 151
collingwoodlighting.com

 @collingwoodLED

 /collingwoodlighting

 collingwoodled

GUARANTEE / WARRANTY

7 year extended warranty

FEATURES & BENEFITS

Improved look and feel with single LED
Low voltage product
Marine grade stainless steel 316
Long lifetime of 70,000hrs
350mA or 700mA driver available



GL040 SPS

LED ground light with single point source lens

FEATURES

Wattage	2.2W (350mA) 4.6W (700mA)
IP rating	IP68
IK rating	IK08
Colour flexibility	Fixed colour
Walk over / drive over	Walk over (5mm toughened glass)
Input	350mA / 700mA
LED lifetime	70,000h L70 B10
SDCM	3SDCM

INSTALLATION INFORMATION

Cut out size	Ø 65mm
Bathroom zone	0
Inrush current	N/A
Construction material	Stainless steel (316)
Weight	818g
Maximum ambient temperature	35°C
SELV	N/A
Electric class [1, 2, 3]	3

PHOTOMETRICS @ 25°C

Product code	Colour	Beam angle	CRI	350mA			700mA		
				lm	lm/W	lx at 1m	lm	lm/W	lx at 1m
GL040DWBX40	4000K	40°	>80Ra	310	141	600	530	115	1027
GL040DNBX40	4000K	12°	>80Ra	310	141	3310	530	115	5659
GL040DWBX30	3000K	40°	>80Ra	300	136	581	520	113	1008
GL040DNBX30	3000K	12°	>80Ra	300	136	3203	520	113	5552
GL040DWBX27	2700K	40°	>80Ra	290	132	562	515	112	998
GL040DNBX27	2700K	12°	>80Ra	290	132	3096	515	112	5499

WIRING INFORMATION

Cable / flying lead	1m (H05RN-F) rubberised cable (outside diameter: 6mm)
Type of wiring required	Series

LED DRIVERS

Product code	Input	SELV	Dimming	Bathroom zone	Min	Max
PLR/350 1-5	220-240V	Yes	No	0	1	3
PLD UNI-DRIVE 350MA	110-240V	Yes	Yes [1-10V]	1	1	8
PLD UNI-DRIVE 700MA	110-240V	Yes	Yes [1-10V]	1	1	7

ACCESSORIES

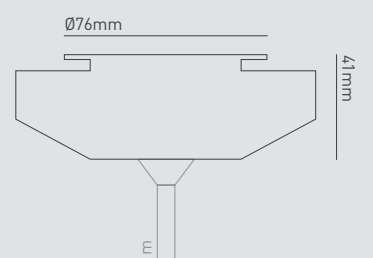
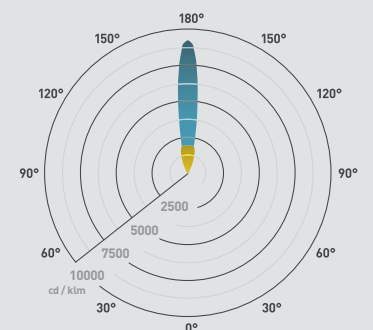

JB2 / JB4 / JB6	IP68 waterproof connectors	Sold separately	422-433
TUBE/68	Installation tube	Sold separately	236

Beam angle: 12° 40°



Ground lights.

01604 495 151
collingwoodlighting.com

-  @collingwoodLED
-  /collingwoodlighting
-  collingwoodled

GUARANTEE / WARRANTY

7 year extended warranty

FEATURES & BENEFITS

A stylish, baffled ground light

Perfect for both interior and exterior applications

Compliments environments with ultra low glare up-lighting effect



GL040 Ultra low-glare

2W LED ground light

FEATURES

Wattage	2W
IP rating	IP68
IK rating	IK08
Colour flexibility	Fixed colour
UGR	<10
Walk over / drive over	Walk over (5mm toughened glass)
Input	350mA / 700mA
LED lifetime	70,000h L70 B10
SDCM	3SDCM

INSTALLATION INFORMATION

Cut out size	Ø 65mm
Bathroom zone	1
Inrush current	N/A
Construction material	Stainless steel (316)
Weight	818g
Maximum ambient temperature	35°C
SELV	N/A
Electric class (1, 2, 3)	3

PHOTOMETRICS @ 25°C

Product code	Colour	Beam angle	CRI	lm	lm/W	lx at 1m
GL040DMBL40	4000K	34°	>80Ra	215	108	694
GL040DNBL40	4000K	12°	>80Ra	215	108	2891
GL040DMBL30	3000K	34°	>80Ra	208	104	671
GL040DNBL30	3000K	12°	>80Ra	208	104	2797
GL040DMBL27	2700K	34°	>80Ra	200	100	645
GL040DNBL27	2700K	12°	>80Ra	200	100	2689

WIRING INFORMATION

Cable / flying lead	1m (H05RN-F) rubberised cable (outside diameter: 6mm)
Type of wiring required	Series

LED DRIVERS

Product code	Input	SELV	Dimming	Bathroom zone	Min	Max
PLU/350 1-9	220-240V	Yes	No	1	1	3
PLR/350 1-5	N/A	Yes	No	0	1	1
PLD UNI-DRIVE 350MA	N/A	Yes	Yes (1-10V)	1	1	3

ACCESSORIES

JB2 / JB4 / JB6	IP68 waterproof connectors	Sold separately	422-433
TUBE/68	Installation tube	Sold separately	236
PDC/GRID DIMMER	Grid dimmer kit for multiple fitting types	Sold separately	422

Beam angle: 12° 34°

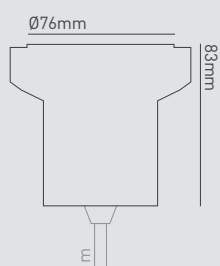
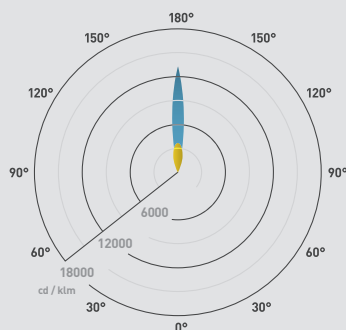

Ground lights.

01604 495 151
collingwoodlighting.com

 @collingwoodLED

 /collingwoodlighting

 collingwoodled

GUARANTEE / WARRANTY

7 year extended warranty

FEATURES & BENEFITS

Equivalent to 20W halogen & 35W AR111

Robust cable for outdoor use

350mA or 700mA driver available



GL041

Square 3W LED ground light

FEATURES

Wattage	3W (350mA) 6W (700mA)
IP rating	IP68
IK rating	IK08
Colour flexibility	Fixed colour
Walk over / drive over	Walk over (5mm toughened glass)
Input	350mA / 700mA
LED lifetime	70,000h L70 B10
SDCM	3SDCM

INSTALLATION INFORMATION

Cut out size	Ø 65mm
Bathroom zone	0
Inrush current	N/A
Construction material	Stainless steel (316)
Weight	760g
Maximum ambient temperature	35°C
SELV	N/A
Electric class [1, 2, 3]	3

PHOTOMETRICS @ 25°C

Product code	Colour	Beam angle	CRI	350mA			700mA		
				lm	lm/W	lx at 1m	lm	lm/W	lx at 1m
GL041 F NW	4000K	20°	>80Ra	200	67	1800	450	75	5163
GL041 S NW	4000K	12°	>80Ra	200	67	4500	450	75	6486
GL041 F WW	3000K	20°	>80Ra	160	53	1253	440	73	2853
GL041 S WW	3000K	12°	>80Ra	160	53	3210	440	73	5049

WIRING INFORMATION

Cable / flying lead	1m (H05RN-F) rubberised cable (outside diameter: 6mm)
Type of wiring required	Series

LED DRIVERS

Product code	Input	SELV	Dimming	Bathroom zone	Min	Max
PLU/350 1-9	220-240V	Yes	No	1	1	3
PLR/350 1-5	N/A	Yes	No	0	1	1
PLD UNI-DRIVE 700MA	N/A	Yes	Yes (1-10V)	1	1	3

ACCESSORIES

JB2 / JB4 / JB6	IP68 waterproof connectors	Sold separately	422-433
TUBE/68	Installation tube	Sold separately	236
PDC/GRID DIMMER	Grid dimmer kit for multiple fitting types	Sold separately	422

Beam angle: 12° 20°

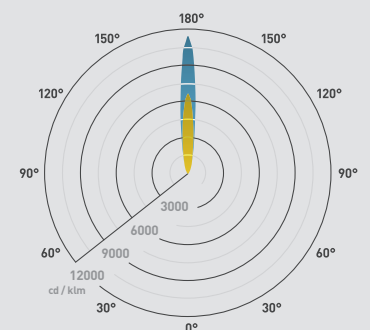

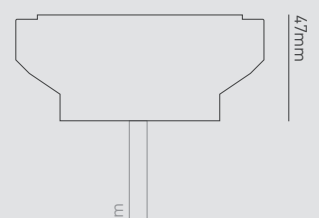

76x76mm



Ground lights.

01604 495 151
collingwoodlighting.com

-  @collingwoodLED
-  /collingwoodlighting
-  collingwoodled

GUARANTEE / WARRANTY

7 year extended warranty

FEATURES & BENEFITS

- Improved look and feel with single LED
- Straight to mains
- Marine grade stainless steel 316
- Long lifetime of 70,000hrs



GL038

LED ground light

FEATURES

Wattage	2.9W
IP rating	IP67
IK rating	IK08
Colour flexibility	Fixed colour
Walk over / drive over	Walk over (5mm toughened glass)
Input	Mains AC
LED lifetime	70,000h L70 B10
SDCM	3SDCM

INSTALLATION INFORMATION

Cut out size	Ø 80-85mm
Bathroom zone	2
Inrush current	60A 0.037ms
Construction material	Stainless steel 316 (top) / Aluminium (body)
Weight	696g
Maximum ambient temperature	35°C
SELV	Yes
Electric class (1, 2, 3)	1

PHOTOMETRICS @ 25°C

Product code	Colour	Beam angle	CRI	lm	lm/W	lx at 1m
GL038DWBM40	4000K	40°	>80Ra	300	103	563
GL038DWBM30	3000K	40°	>80Ra	290	100	544
GL038DWBM27	2700K	40°	>80Ra	280	96	526

WIRING INFORMATION

Cable / flying lead	1m H05RN-F rubberised cable (outside diameter: 7mm)
Type of wiring required	Parallel

LED DRIVERS

Product code	Input	SELV	Dimming	Bathroom zone	Min	Max
N/A (integrated SELV driver)	220-240V	Yes	No	2		

ACCESSORIES

Installation tube	Included	236
JB5	Gel filled waterproof connector	Sold separately 423
WC 5-9	Quick release waterproof joint	Sold separately 422

Beam angle: 40°

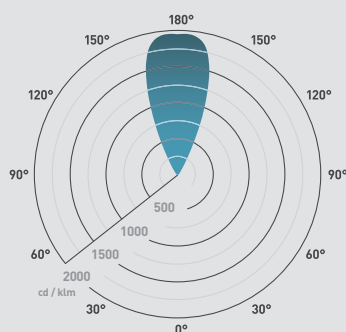

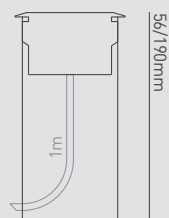

Ø98mm



Ground lights.

01604 495 151
collingwoodlighting.com

-  @collingwoodLED
-  /collingwoodlighting
-  collingwoodled

GUARANTEE / WARRANTY

7 year extended warranty

FEATURES & BENEFITS

- New - can now also be used with a 700mA driver for increased light output
- Compact yet powerful fitting
- Shallow depth for easy installation
- Robust cable for outdoor use
- 350mA or 700mA driver available



GL019

1W mini LED ground light

FEATURES

Wattage	1W (350mA) 2W (700mA)
IP rating	IP68
IK rating	IK07
Colour flexibility	Fixed colour
Walk over / drive over	Walk over (5mm toughened glass)
Input	350mA / 700mA
LED lifetime	70,000h L70 B10
SDCM	3SDCM

INSTALLATION INFORMATION

Cut out size	Ø 33mm
Bathroom zone	0
Inrush current	N/A
Construction material	Stainless steel (316)
Weight	204g
Maximum ambient temperature	50°C
SELV	N/A
Electric class (1, 2, 3)	3

PHOTOMETRICS @ 25°C

Product code	Colour	Beam angle	CRI	350mA			700mA		
				lm	lm/W	lx at 1m	lm	lm/W	lx at 1m
GL019 F NW	4000K	38°	>80Ra	100	100	356	180	90	641
GL019 S NW	4000K	12°	>80Ra	100	100	1543	180	90	3087
GL019 F WW	3000K	38°	>80Ra	90	90	320	150	75	534
GL019 S WW	3000K	12°	>80Ra	90	90	1543	150	75	2572
GL019 F 27	2700K	38°	>80Ra	80	80	285	130	65	463
GL019 S 27	2700K	12°	>80Ra	80	80	1372	130	65	2229
GL019 F AMBER	Amber	38°	-	20	20	88	-	-	-
GL019 S AMBER	Amber	12°	-	20	20	407	-	-	-
GL019 F BLUE	Blue	38°	-	10	10	66	25	13	88
GL019 S BLUE	Blue	12°	-	10	10	509	25	13	407
GL019 F GREEN	Green	38°	-	80	80	352	120	60	528
GL019 S GREEN	Green	12°	-	80	80	1630	120	60	2444
GL019 F RED	Red	38°	-	35	35	154	-	-	-
GL019 S RED	Red	12°	-	35	35	712	-	-	-

WIRING INFORMATION

Cable / flying lead	1m (H05RN-F) rubberised cable (outside diameter: 6mm)
Type of wiring required	Series

LED DRIVERS

Product code	Input	SELV	Dimming	Bathroom zone	Min	Max
PLR/350 1-5	220-240V	Yes	No	0	1	5
PLU/700 3-9	N/A	Yes	No	1	3	9

ACCESSORIES

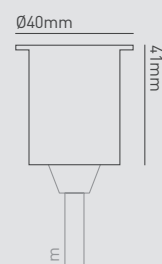
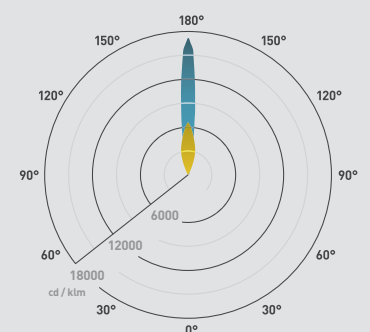

JB2 / JB4 / JB6	IP68 waterproof connectors	Sold separately	422-423
TUBE332	Installation tube	Sold separately	236

Beam angle: 12° 38°



Ground lights.

01604 495 151
collingwoodlighting.com

-  @collingwoodLED
-  /collingwoodlighting
-  collingwoodled

GUARANTEE / WARRANTY

7 year extended warranty

FEATURES & BENEFITS

A stylish, baffled mini ground light

Perfect for both interior and exterior applications

Compliments environments with ultra low glare up-lighting effect



GL019 Ultra low-glare

1W mini LED ground light

FEATURES

Wattage	1W
IP rating	IP68
IK rating	IK07
Colour flexibility	Fixed colour
UGR	<10
Walk over / drive over	Walk over (5mm toughened glass)
Input	350mA / 700mA
LED lifetime	70,000h L70 B10
SDCM	3SDCM

INSTALLATION INFORMATION

Cut out size	Ø 33mm
Bathroom zone	0
Inrush current	N/A
Construction material	Stainless steel (316)
Weight	260g
Maximum ambient temperature	50°C
SELV	N/A
Electric class (1, 2, 3)	3

PHOTOMETRICS @ 25°C

Product code	Colour	Beam angle	CRI	lm	lm/W	lx at 1m
GL019DMBL40	4000K	30°	>80Ra	68	68	125
GL019DNBL40	4000K	12°	>80Ra	78	78	2369
GL019DMBL30	3000K	30°	>80Ra	64	64	25
GL019DNBL30	3000K	12°	>80Ra	74	74	1324
GL019DMBL27	2700K	30°	>80Ra	60	60	24
GL019DNBL27	2700K	12°	>80Ra	70	70	1292

WIRING INFORMATION

Cable / flying lead	1m (H05RN-F) rubberised cable (outside diameter: 6mm)
Type of wiring required	Series

LED DRIVERS

Product code	Input	SELV	Dimming	Bathroom zone	Min	Max
PLU/350 1-9	220-240V	Yes	No	1	1	9
PLR/350 1-5	N/A	Yes	No	0	1	5
PLD UNI-DRIVE 350MA	N/A	Yes	Yes (1-10V)	1	1	10

ACCESSORIES

JB2 / JB4 / JB6	IP68 waterproof connectors	Sold separately	422-423
TUBE332	Installation tube	Sold separately	236
PDC/GRID DIMMER	Grid dimmer kit for multiple fitting types	Sold separately	422

Beam angle: 12° 30°

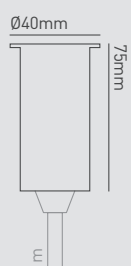
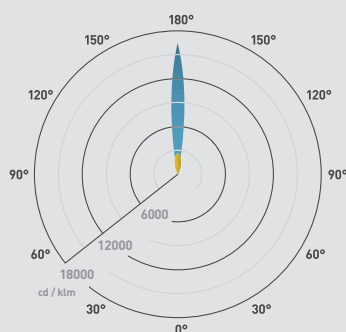

Ground lights.

01604 495 151
collingwoodlighting.com

 @collingwoodLED

 /collingwoodlighting

 collingwoodled

GUARANTEE / WARRANTY

7 year extended warranty

FEATURES & BENEFITS

- Compact yet powerful fitting
- Shallow depth for easy installation
- Robust cable for outdoor use
- Built-in glare reducing honeycomb baffle



GL019 LG

1W mini low glare LED ground light

FEATURES

Wattage	1W
IP rating	IP68
IK rating	IK07
Colour flexibility	Fixed colour
UGR	<10
Walk over / drive over	Walk over (5mm toughened glass)
Input	350mA / 700mA
LED lifetime	70,000h L70 B10
SDCM	3SDCM

INSTALLATION INFORMATION

Cut out size	Ø 33mm
Bathroom zone	0
Inrush current	N/A
Construction material	Stainless steel (316)
Weight	204g
Maximum ambient temperature	50°C
SELV	N/A
Electric class [1, 2, 3]	3

PHOTOMETRICS @ 25°C

Product code	Colour	Beam angle	CRI	lm	lm/W	Lx at 1m
GL019LGFNW	4000K	30°	>80Ra	65	65	262
GL019LGSNW	4000K	12°	>80Ra	65	65	908
GL019LGFWW	3000K	30°	>80Ra	55	55	222
GL019LGSWW	3000K	12°	>80Ra	55	55	768
GL019LGF27	2700K	30°	>80Ra	53	53	214
GL019LGS27	2700K	12°	>80Ra	53	53	740

WIRING INFORMATION

Cable / flying lead	1m (H05RN-F) rubberised cable (outside diameter: 6mm)
Type of wiring required	Series

LED DRIVERS

Product code	Input	SELV	Dimming	Bathroom zone	Min	Max
PLU/350 1-9	220-240V	Yes	No	1	1	9
PLR/350 1-5	N/A	Yes	No	0	1	5
PLD UNI-DRIVE 350MA	N/A	Yes	Yes (1-10V)	1	1	10

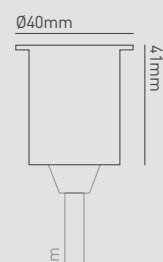
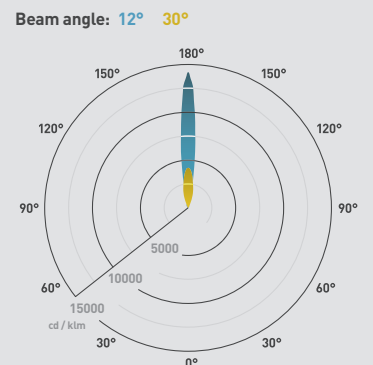

ACCESSORIES

JB2 / JB4 / JB6	IP68 waterproof connectors	Sold separately	422-423
TUBE332	Installation tube	Sold separately	236
PDC/GRID DIMMER	Grid dimmer kit for multiple fitting types	Sold separately	422



Ground lights.

01604 495 151
collingwoodlighting.com

-  @collingwoodLED
-  /collingwoodlighting
-  collingwoodled

GUARANTEE / WARRANTY

7 year extended warranty

FEATURES & BENEFITS

- Frosted effect for softer light
- Robust cable for outdoor use
- Shallow depth for easy installation

Beam angle: 100°

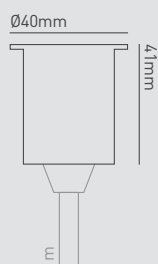
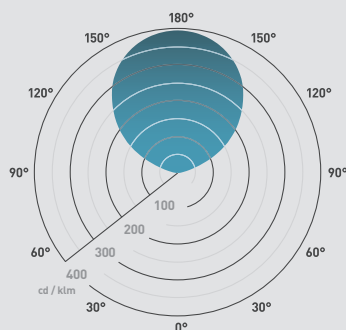

GL019 Frosted

Frosted 1W mini LED ground / marker light

FEATURES

Wattage	1W
IP rating	IP68
IK rating	IK07
Colour flexibility	Fixed colour
Walk over / drive over	Walk over (5mm toughened glass)
Input	350mA / 700mA
LED lifetime	70,000h L70 B10
SDCM	3SDCM

INSTALLATION INFORMATION

Cut out size	Ø 33mm
Bathroom zone	0
Inrush current	N/A
Construction material	Stainless steel (316)
Weight	196g
Maximum ambient temperature	50°C
SELV	N/A
Electric class (1, 2, 3)	3

PHOTOMETRICS @ 25°C

Product code	Colour	Beam angle	CRI	lm	lm/W	lx at 1m
GL019DC0F40	4000K	100°	>80Ra	13	13	5
GL019DC0F30	3000K	100°	>80Ra	11	11	4
GL019DC0F27	2700K	100°	>80Ra	10	10	4

WIRING INFORMATION

Cable / flying lead	1m (H05RN-F) rubberised cable (outside diameter: 6mm)
Type of wiring required	Series

LED DRIVERS

Product code	Input	SELV	Dimming	Bathroom zone	Min	Max
PLU/350 1-9	220-240V	Yes	No	1	1	9
PLR/350 1-5	N/A	Yes	No	0	1	5
PLD UNI-DRIVE 350MA	N/A	Yes	Yes (1-10V)	1	1	10

ACCESSORIES

JB2 / JB4 / JB6	IP68 waterproof connectors	Sold separately	422-423
TUBE332	Installation tube	Sold separately	236
WCR 275 BLACK	2-core rubber cable	Sold separately	423
PDC/GRID DIMMER	Grid dimmer kit for multiple fitting types	Sold separately	422



GL019 SQ

1W square mini LED ground light

FEATURES

Wattage	1W (350mA) 2W (700mA)
IP rating	IP68
IK rating	IK07
Colour flexibility	Fixed colour
Walk over / drive over	Walk over (5mm toughened glass)
Input	350mA / 700mA
LED lifetime	70,000h L70, B10
SDCM	3SDCM

INSTALLATION INFORMATION

Cut out size	Ø 33mm
Bathroom zone	0
Inrush current	N/A
Construction material	Stainless steel (316)
Weight	134g
Maximum ambient temperature	35°C
SELV	N/A
Electric class [1, 2, 3]	3

PHOTOMETRICS @ 25°C

Product code	Colour	Beam angle	CRI	350mA			700mA		
				lm	lm/W	lx at 1m	lm	lm/W	lx at 1m
GL019 SQ F NW	4000K	20°	>80Ra	90	90	396	130	65	572
GL019 SQ S NW	4000K	12°	>80Ra	90	90	1833	130	65	2648
GL019 SQ F WW	3000K	20°	>80Ra	80	80	353	125	63	551
GL019 SQ F BLUE	Blue	20°	-	10	10	44	20	10	88
GL019 SQ S BLUE	Blue	12°	-	10	10	204	20	10	407

WIRING INFORMATION

Cable / flying lead	1m (H05RN-F) rubberised cable (outside diameter: 6mm)
Type of wiring required	Series

LED DRIVERS

Product code	Input	SELV	Dimming	Bathroom zone	Min	Max
PLU/350 1-9	220-240V	Yes	No	1	1	9
PLD UNI-DRIVE 350MA	N/A	Yes	Yes [1-10V]	1	1	10
PLU/700 3-9	N/A	Yes	No	1	3	9

ACCESSORIES

JB2 / JB4 / JB6	IP68 waterproof connectors	Sold separately	422-423
TUBE332	Installation tube	Sold separately	236
PDC/GRID DIMMER	Grid dimmer kit for multiple fitting types	Sold separately	422

Ground lights.

01604 495 151
collingwoodlighting.com

@collingwoodLED

/collingwoodlighting

collingwoodled

GUARANTEE / WARRANTY

7 year extended warranty

FEATURES & BENEFITS

New - can now also be used with a 700mA driver for increased light output (see page 282 for driver matrix)

Shallow depth for easy installation

Square fascia for a different decorative effect

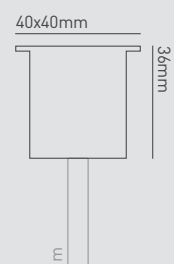
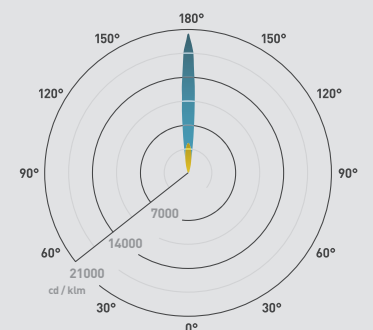

350mA or 700mA driver available

Beam angle: 12° 20°



Ground lights.

01604 495 151
collingwoodlighting.com

 @collingwoodLED
 /collingwoodlighting
 collingwoodled

GUARANTEE / WARRANTY

7 year extended warranty

FEATURES & BENEFITS

New - can now also be used with a 700mA driver for increased light output (see page 282 for driver matrix)

Incorporated thread and nut for secure fitting into panels, walls or ceilings

Shallow depth for easy installation

350mA or 700mA driver available



GL019 S T

1W mini LED ground light threaded

FEATURES

Wattage	1W (350mA) 2W (700mA)
IP rating	IP68
IK rating	IK07
Colour flexibility	Fixed colour
Walk over / drive over	Walk over (5mm toughened glass)
Input	350mA / 700mA
LED lifetime	70,000h L70 B10
SDCM	3SDCM

INSTALLATION INFORMATION

Cut out size	Ø 32mm
Bathroom zone	0
Inrush current	N/A
Construction material	Stainless steel (316)
Weight	140g
Maximum ambient temperature	50°C
SELV	N/A
Electric class (1, 2, 3)	3

PHOTOMETRICS @ 25°C

Product code	Colour	Beam angle	CRI	350mA			700mA		
				lm	lm/W	lx at 1m	lm	lm/W	lx at 1m
GL019 S T NW	4000K	12°	>80Ra	90	90	1833	130	65	2648
GL019 S T WW	3000K	12°	>80Ra	80	80	1629	125	63	2545
GL019 S T 27	2700K	12°	>80Ra	70	70	1425	115	58	2341
GL019 S T BLUE	Blue	12°	-	10	10	204	20	10	407

WIRING INFORMATION

Cable / flying lead	1m (H05RN-F) rubberised cable (outside diameter: 6mm)
Type of wiring required	Series

LED DRIVERS

Product code	Input	SELV	Dimming	Bathroom zone	Min	Max
PLU/350 1-9	220-240V	Yes	No	1	1	9
PLD UNI-DRIVE 350MA	N/A	Yes	Yes (1-10V)	1	1	10
PLU/700 3-9	N/A	Yes	No	1	3	9

ACCESSORIES

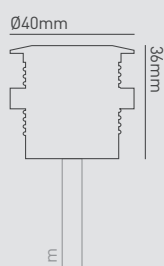
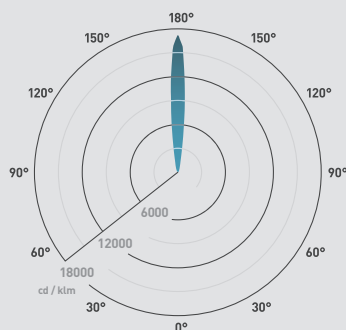

JB2 / JB4 / JB6	IP68 waterproof connectors	Sold separately	422-423
PDC/GRID DIMMER	Grid dimmer kit for multiple fitting types	Sold separately	422

Beam angle: 12°



Ground lights.

01604 495 151
collingwoodlighting.com

-  @collingwoodLED
-  /collingwoodlighting
-  collingwoodled

GUARANTEE / WARRANTY

7 year extended warranty

FEATURES & BENEFITS

New - can now also be used with a 700mA driver for increased light output (see page 282 for driver matrix)

Theft/vandal-proof. Threaded body fits securely into supplied aluminium tube using tightening key

Aluminium tube for secure installation in concrete or soft ground environments

Low profile waterproof ground light. Ideal for decking or by swimming pools

350mA or 700mA driver available



GL019 S TK

1W mini LED ground light threaded kit

FEATURES

Wattage	1W (350mA) 2W (700mA)
IP rating	IP68
IK rating	IK07
Colour flexibility	Fixed colour
Walk over / drive over	Walk over (5mm toughened glass)
Input	350mA / 700mA
LED lifetime	70,000h L70 B10
SDCM	3SDCM

INSTALLATION INFORMATION

Cut out size	Ø 37mm
Bathroom zone	0
Inrush current	N/A
Construction material	Stainless steel (316)
Weight	304g
Maximum ambient temperature	50°C
SELV	N/A
Electric class [1, 2, 3]	3

PHOTOMETRICS @ 25°C

Product code	Colour	Beam angle	CRI	350mA			700mA		
				lm	lm/W	lx at 1m	lm	lm/W	lx at 1m
GL019 S TK NW	4000K	12°	>80Ra	90	90	1833	130	65	2648
GL019 S TK 27	2700K	12°	>80Ra	70	70	1425	115	58	2341
GL019 S TK BLUE	Blue	12°	-	10	10	204	20	10	407

WIRING INFORMATION

Cable / flying lead	1m (H05RN-F) rubberised cable (outside diameter: 6mm)
Type of wiring required	Series

LED DRIVERS

Product code	Input	SELV	Dimming	Bathroom zone	Min	Max
PLU/350 1-9	220-240V	Yes	No	1	1	9
PLD UNI-DRIVE 350MA	N/A	Yes	Yes (1-10V)	1	1	10
PLU/700 3-9	N/A	Yes	No	1	3	9

ACCESSORIES

JB2 / JB4 / JB6	IP68 waterproof connectors	Sold separately	422-423
PDC/GRID DIMMER	Grid dimmer kit for multiple fitting types	Sold separately	422

Beam angle: 12°

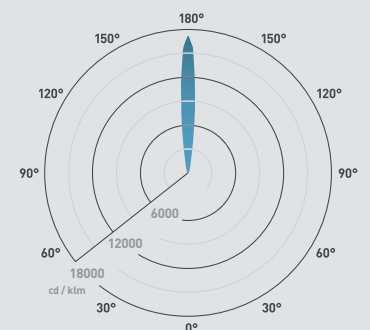

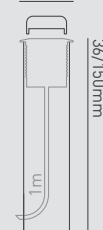

Ø40/37mm



Ground lights.

01604 495 151
collingwoodlighting.com

-  @collingwoodLED
-  /collingwoodlighting
-  collingwoodled

GUARANTEE / WARRANTY

7 year extended warranty

FEATURES & BENEFITS

Can now also be used with a 700mA driver for increased light output

Robust cable for outdoor use

Shallow depth for easy installation

350mA or 700mA driver available



GL016

1W LED ground light

FEATURES

Wattage	1W (350mA) 2W (700mA)
IP rating	IP68
IK rating	IK09
Colour flexibility	Fixed colour
Walk over / drive over	Walk over (5mm toughened glass)
Input	350mA / 700mA
LED lifetime	70,000h L70 B10
SDCM	3SDCM

INSTALLATION INFORMATION

Cut out size	Ø 50mm
Bathroom zone	0
Inrush current	N/A
Construction material	Stainless steel (316)
Weight	400g
Maximum ambient temperature	50°C
SELV	N/A
Electric class (1, 2, 3)	3

PHOTOMETRICS @ 25°C

Product code	Colour	Beam angle	CRI	350mA			700mA		
				lm	lm/W	lx at 1m	lm	lm/W	lx at 1m
GL016 F NW	4000K	26°	>80Ra	95	95	267	140	70	393
GL016 F WW	3000K	26°	>80Ra	75	75	210	135	68	379
GL016 F 27	2700K	26°	>80Ra	70	70	196	120	60	337
GL016 F AMBER	Amber	26°	-	-	-	-	-	-	-
GL016 F BLUE	Blue	26°	-	20	20	28	20	10	56
GL016 F GREEN	Green	26°	-	75	75	211	110	55	310
GL016 F RED	Red	26°	-	-	-	-	-	-	-

WIRING INFORMATION

Cable / flying lead	1m (H05RN-F) rubberised cable (outside diameter: 6mm)
Type of wiring required	Series

LED DRIVERS

Product code	Input	SELV	Dimming	Bathroom zone	Min	Max
PLU/350 1-9	220-240V	Yes	No	1	1	9
PLD UNI-DRIVE 350MA	N/A	Yes	Yes (1-10V)	1	1	10
PLU/700 3-9	N/A	Yes	No	1	3	9

ACCESSORIES

JB2 / JB4 / JB6	IP68 waterproof connectors	Sold separately	422-423
TUBE/50	Installation tube	Sold separately	236
WCR 275 BLACK	2-core rubber cable	Sold separately	423
PDC/GRID DIMMER	Grid dimmer kit for multiple fitting types	Sold separately	422

Beam angle: 26°

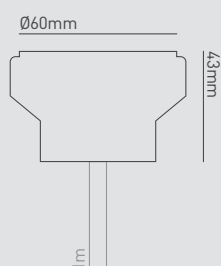
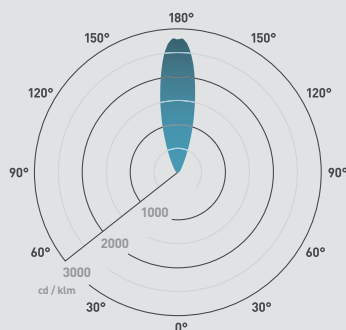

Ground lights.

01604 495 151
collingwoodlighting.com

 @collingwoodLED

 /collingwoodlighting

 collingwoodled

GUARANTEE / WARRANTY

7 year extended warranty

FEATURES & BENEFITS

Can now also be used with a 700mA driver for increased light output

Robust cable for outdoor use

Shallow depth for easy installation

Solid brass for antique effect

350mA or 700mA driver available

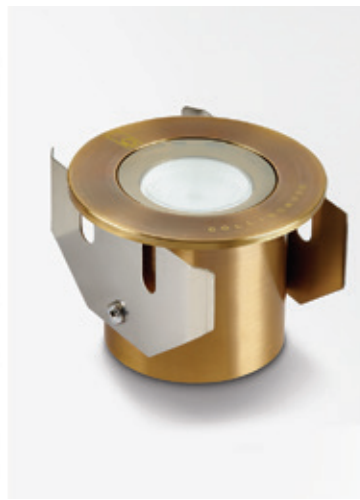
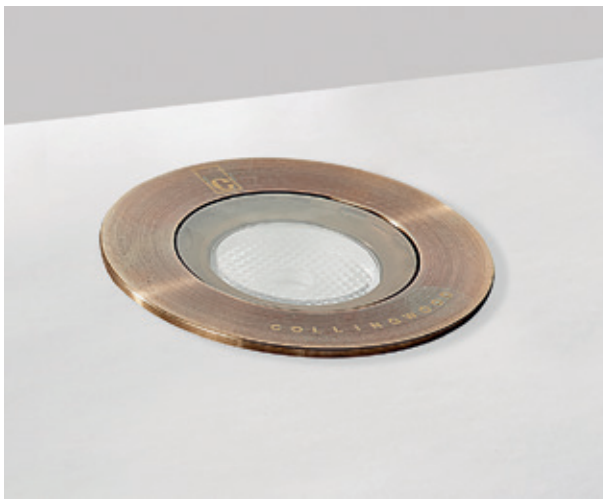

GL016 F AB

1W LED ground light

FEATURES

Wattage	1W (350mA) 2W (700mA)
IP rating	IP68
IK rating	IK09
Colour flexibility	Fixed colour
Walk over / drive over	Walk over (5mm toughened glass)
Input	350mA / 700mA
LED lifetime	70,000h L70 B10
SDCM	3SDCM

INSTALLATION INFORMATION

Cut out size	Ø 50mm
Bathroom zone	0
Inrush current	N/A
Construction material	Brass
Weight	400g
Maximum ambient temperature	50°C
SELV	N/A
Electric class [1, 2, 3]	3

PHOTOMETRICS @ 25°C

Product code	Colour	Beam angle	CRI	350mA			700mA		
				lm	lm/W	lx at 1m	lm	lm/W	lx at 1m
GL016 F AB NW	4000K	26°	>80Ra	95	95	267	140	70	393
GL016 F AB WW	3000K	26°	>80Ra	75	75	210	135	68	379
GL016 F AB 27	2700K	26°	>80Ra	70	70	196	120	60	337
GL016 F AB AMBER	Amber	26°	-	-	-	-	-	-	-
GL016 F AB BLUE	Blue	26°	-	20	20	28	20	10	56
GL016 F AB GREEN	Green	26°	-	75	75	211	110	55	310
GL016 F AB RED	Red	26°	-	-	-	-	-	-	-

WIRING INFORMATION

Cable / flying lead	1m (H05RN-F) rubberised cable (outside diameter: 6mm)
Type of wiring required	Series

LED DRIVERS

Product code	Input	SELV	Dimming	Bathroom zone	Min	Max
PLR/350 1-5	220-240V	Yes	No	0	1	5
PLD UNI-DRIVE 350MA	N/A	Yes	Yes (1-10V)	1	1	10
PLU/700 3-9	N/A	Yes	No	1	3	9

ACCESSORIES

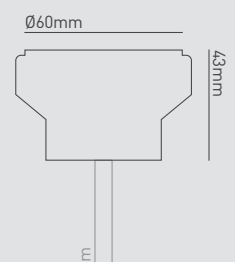
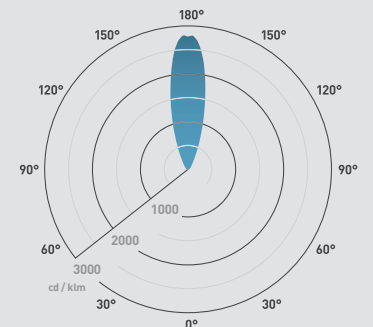

JB2 / JB4 / JB6	IP68 waterproof connectors	Sold separately	422-423
TUBE/50	Installation tube	Sold separately	236
WCR 275 BLACK	2-core rubber cable	Sold separately	423
PDC/GRID DIMMER	Grid dimmer kit for multiple fitting types	Sold separately	422

Beam angle: 26°



Ground lights.

01604 495 151
collingwoodlighting.com

-  @collingwoodLED
-  /collingwoodlighting
-  collingwoodled

GUARANTEE / WARRANTY

7 year extended warranty

FEATURES & BENEFITS

- Can now also be used with a 700mA driver for increased light output
- Robust cable for outdoor use
- Shallow depth for easy installation
- 350mA or 700mA driver available



GL016 SQ

Square 1W LED ground light

FEATURES

Wattage	1W (350mA) 2W (700mA)
IP rating	IP68
IK rating	IK09
Colour flexibility	Fixed colour
Walk over / drive over	Walk over (5mm toughened glass)
Input	350mA / 700mA
LED lifetime	70,000h L70 B10
SDCM	3SDCM

INSTALLATION INFORMATION

Cut out size	Ø 50mm
Bathroom zone	0
Inrush current	N/A
Construction material	Stainless steel (316)
Weight	400g
Maximum ambient temperature	50°C
SELV	N/A
Electric class (1, 2, 3)	3

PHOTOMETRICS @ 25°C

Product code	Colour	Beam angle	CRI	350mA			700mA		
				lm	lm/W	lx at 1m	lm	lm/W	lx at 1m
GL016 SQ NW	4000K	26°	>80Ra	95	95	267	140	70	381
GL016 SQ WW	3000K	26°	>80Ra	75	75	210	135	68	379
GL016 SQ 27	2700K	26°	>80Ra	70	70	196	120	60	337
GL016 SQ BLUE	Blue	26°	-	20	20	28	20	10	56

WIRING INFORMATION

Cable / flying lead	1m (H05RN-F) rubberised cable (outside diameter: 6mm)
Type of wiring required	Series

LED DRIVERS

Product code	Input	SELV	Dimming	Bathroom zone	Min	Max
PLU/350 1-9	220-240V	Yes	No	1	1	9
PLD UNI-DRIVE 350MA	N/A	Yes	Yes (1-10V)	1	1	10
PLU/700 3-9	N/A	Yes	No	1	3	9

ACCESSORIES

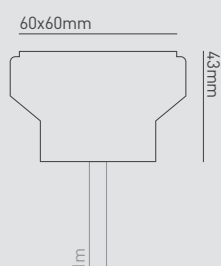
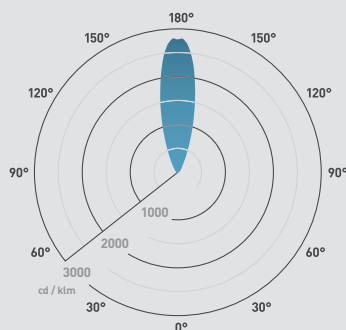

JB2 / JB4 / JB6	IP68 waterproof connectors	Sold separately	422-423
TUBE/50	Installation tube	Sold separately	236
WCR 275 BLACK	2-core rubber cable	Sold separately	423
PDC/GRID DIMMER	Grid dimmer kit for multiple fitting types	Sold separately	422

Beam angle: 26°



Ground lights.

01604 495 151
collingwoodlighting.com

-  @collingwoodLED
-  /collingwoodlighting
-  collingwoodled

GUARANTEE / WARRANTY

7 year extended warranty

FEATURES & BENEFITS

- Frosted effect for softer light
- Robust cable for outdoor use
- Shallow depth for easy installation



GL016 Frosted

Frosted 1W LED ground / marker light

FEATURES

Wattage	1W
IP rating	IP68
IK rating	IK09
Colour flexibility	Fixed colour
Walk over / drive over	Walk over (5mm toughened glass)
Input	350mA / 700mA
LED lifetime	70,000h L70, B10
SDCM	3SDCM

INSTALLATION INFORMATION

Cut out size	Ø 50mm
Bathroom zone	0
Inrush current	N/A
Construction material	Stainless steel (316)
Weight	400g
Maximum ambient temperature	35°C
SELV	N/A
Electric class [1, 2, 3]	3

PHOTOMETRICS @ 25°C

Product code	Colour	Beam angle	CRI	lm	lm/W	lx at 1m
GL016DC0F40	4000K	100°	>80Ra	15	15	5
GL016DC0F30	3000K	100°	>80Ra	13	13	5
GL016DC0F27	2700K	100°	>80Ra	12	12	4

WIRING INFORMATION

Cable / flying lead	1m (H05RN-F) rubberised cable (outside diameter: 6mm)
Type of wiring required	Series

LED DRIVERS

Product code	Input	SELV	Dimming	Bathroom zone	Min	Max
PLU/350 1-9	220-240V	Yes	No	1	1	9
PLR/350 1-5	N/A	Yes	No	0	1	5
PLD UNI-DRIVE 350MA	N/A	Yes	Yes (1-10V)	1	1	10

ACCESSORIES

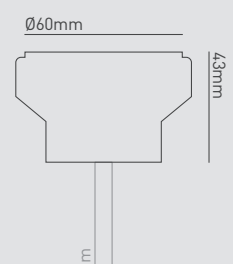
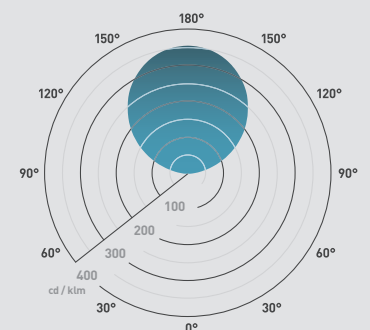

JB2 / JB4 / JB6	IP68 waterproof connectors	Sold separately	422-423
TUBE/50	Installation tube	Sold separately	236
WCR 275 BLACK	2-core rubber cable	Sold separately	423
PDC/GRID DIMMER	Grid dimmer kit for multiple fitting types	Sold separately	422

Beam angle: 100°



Ground lights.

01604 495 151
collingwoodlighting.com

-  @collingwoodLED
-  /collingwoodlighting
-  collingwoodled

GUARANTEE / WARRANTY

7 year extended warranty

FEATURES & BENEFITS

- Cast stainless steel for aged effect
- Raised profile sending light in three or four directions

Plane: **C0/C180 C90/C270**

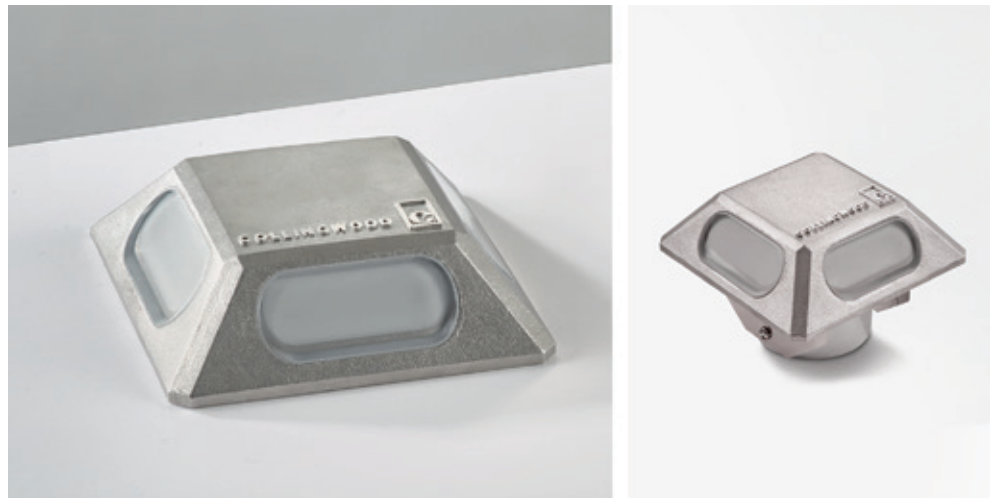
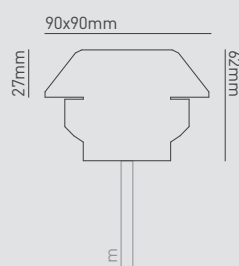
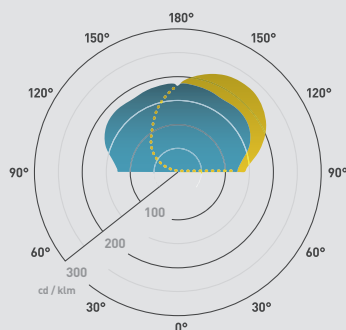

GL063

3-way LED marker light

FEATURES

Wattage	3W
IP rating	IP67
IK rating	IK10
Colour flexibility	Fixed colour
Walk over / drive over	No
Input	350mA
LED lifetime	70,000h L70 B10
SDCM	3SDCM

INSTALLATION INFORMATION

Cut out size	Ø 55mm
Bathroom zone	1
Inrush current	N/A
Construction material	Cast stainless steel (316)
Weight	1.165Kg
Maximum ambient temperature	35°C
SELV	N/A
Electric class (1, 2, 3)	3

PHOTOMETRICS @ 25°C

Product code	Colour	CRI	lm	lm/W	lx at 1m
GL063	3000K	>80Ra	45	15	9
GL063 27	2700K	>80Ra	44	15	9

WIRING INFORMATION

Cable / flying lead	1m (H05RN-F) rubberised cable (outside diameter: 6mm)
Type of wiring required	Series

LED DRIVERS



Product code	Input	SELV	Dimming	Bathroom zone	Min	Max
PLU/350 1-9	220-240V	Yes	No	1	1	3/2
PLR/350 1-5	N/A	Yes	No	1	1	1
PLD UNI-DRIVE 350MA	N/A	Yes	Yes (1-10V)	2	1	3/2

ACCESSORIES

JB2 / JB4 / JB6	IP68 waterproof connectors	Sold separately	422-423
TUBE/68	Installation tube	Sold separately	236
WCR 275 BLACK	2-core rubber cable	Sold separately	423

Ground lights.

01604 495 151
collingwoodlighting.com

-  @collingwoodLED
-  /collingwoodlighting
-  collingwoodled

GUARANTEE / WARRANTY

7 year extended warranty

FEATURES & BENEFITS

- Cast stainless steel for aged effect
- Raised profile sending light in three or four directions

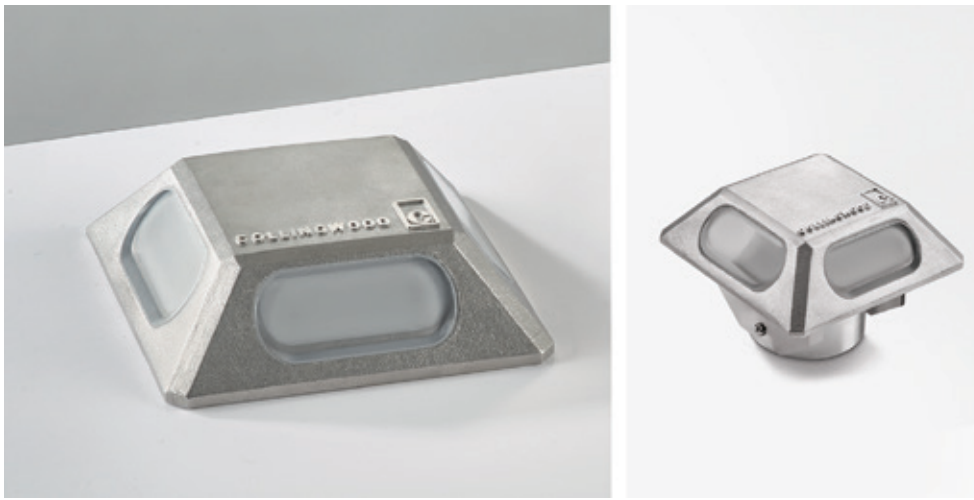

GL064

4-way LED marker light

FEATURES

Wattage	4W
IP rating	IP67
IK rating	IK10
Colour flexibility	Fixed colour
Walk over / drive over	No
Input	350mA
LED lifetime	70,000h L70 B10
SDCM	3SDCM

INSTALLATION INFORMATION

Cut out size	Ø 55mm
Bathroom zone	1
Inrush current	N/A
Construction material	Cast stainless steel (316)
Weight	1.165Kg
Maximum ambient temperature	35°C
SELV	N/A
Electric class (1, 2, 3)	3

PHOTOMETRICS @ 25°C

Product code	Colour	CRI	lm	lm/W	lx at 1m
GL064	3000K	>80Ra	65	16	9
GL064 27	2700K	>80Ra	63	16	9

WIRING INFORMATION

Cable / flying lead	1m (H05RN-F) rubberised cable (outside diameter: 6mm)
Type of wiring required	Series

LED DRIVERS

Product code	Input	SELV	Dimming	Bathroom zone	Min	Max
PLU/350 1-9	220-240V	Yes	No	1	1	3/2
PLR/350 1-5	N/A	Yes	No	1	1	1
PLD UNI-DRIVE 350MA	N/A	Yes	Yes (1-10V)	2	1	3/2

ACCESSORIES

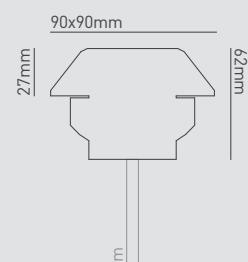
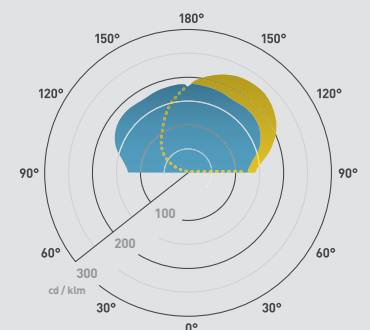

JB2 / JB4 / JB6	IP68 waterproof connectors	Sold separately	422-423
TUBE/68	Installation tube	Sold separately	236
WCR 275 BLACK	2-core rubber cable	Sold separately	423

Plane: C0/C180 C90/C270



Ground lights.

01604 495 151
collingwoodlighting.com

-  @collingwoodLED
-  /collingwoodlighting
-  collingwoodled

GUARANTEE / WARRANTY

7 year extended warranty

FEATURES & BENEFITS

Walk over - perfect for foot traffic areas such as paths and steps

Marine-grade stainless steel 316

IP68

Long-lifetime of 70,000hrs

Low power consumption of 1W

350mA or 700mA driver available



GL100 (1 window - 2 windows)

Small domed marker light

FEATURES

Wattage	1W (350mA) 2W (700mA)
IP rating	IP68
IK rating	IK07
Colour flexibility	Fixed colour
Walk over / drive over	Walk over
Input	350mA / 700mA
LED lifetime	70,000h L70 B10
SDCM	3SDCM

INSTALLATION INFORMATION

Cut out size	Ø 33mm
Bathroom zone	0
Inrush current	N/A
Construction material	Stainless steel (316)
Weight	221g
Maximum ambient temperature	35°C
SELV	N/A
Electric class (1, 2, 3)	3

PHOTOMETRICS @ 25°C

Product code	Window style	Colour	Beam angle	CRI	350mA		700mA	
					lm	lm/W	lm	lm/W
GL100DX1X40	1 window	4000K	75°	>80Ra	3	3	4	2
GL100DX1X30	1 window	3000K	75°	>80Ra	2	2	4	2
GL100DX1X27	1 window	2700K	75°	>80Ra	2	2	3	2
GL100DX2140	2 windows, 1 direction	4000K	75°	>80Ra	6	6	7	4
GL100DX2130	2 windows, 1 direction	3000K	75°	>80Ra	4	4	8	4
GL100DX2127	2 windows, 1 direction	2700K	75°	>80Ra	4	4	6	3
GL100DX2240	2 windows, 2 directions	4000K	75°	>80Ra	6	6	7	4
GL100DX2230	2 windows, 2 directions	3000K	75°	>80Ra	4	4	8	4
GL100DX2227	2 windows, 2 directions	2700K	75°	>80Ra	4	4	6	3

WIRING INFORMATION

Cable / flying lead	1m (H05RN-F) rubberised cable (outside diameter: 6mm)
Type of wiring required	Series

LED DRIVERS

Product code	Input	SELV	Dimming	Bathroom zone	Min	Max
PLR/350 1-5	220-240V	Yes	No	0	1	5
PLD UNI-DRIVE 350MA	N/A	Yes	Yes (1-10V)	1	1	10
PLU/700 3-9	N/A	Yes	No	1	3	9

ACCESSORIES

JB2 / JB4 / JB6	IP68 waterproof connectors	Sold separately	422-423
TUBE332	Installation tube	Sold separately	236
PDC/GRID DIMMER	Grid dimmer kit for multiple fitting types	Sold separately	422

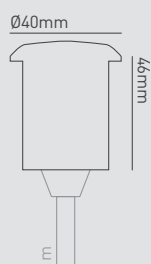
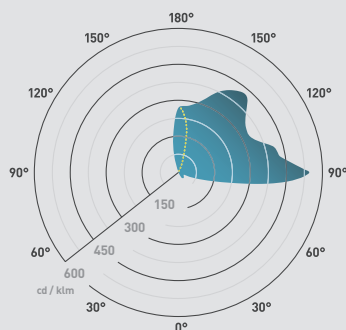

Beam angle: 75°





Ground lights.

01604 495 151
collingwoodlighting.com

-  @collingwoodLED
-  /collingwoodlighting
-  collingwoodled

GL100 (3 windows - 4 windows)

Small domed marker light

FEATURES

Wattage	1W (350mA) 2W (700mA)
IP rating	IP68
IK rating	IK07
Colour flexibility	Fixed colour
Walk over / drive over	Walk over
Input	350mA / 700mA
LED lifetime	70,000h L70 B10
SDCM	3SDCM

INSTALLATION INFORMATION

Cut out size	Ø 33mm
Bathroom zone	0
Inrush current	N/A
Construction material	Stainless steel (316)
Weight	221g
Maximum ambient temperature	35°C
SELV	N/A
Electric class [1, 2, 3]	3

GUARANTEE / WARRANTY

7 year extended warranty

FEATURES & BENEFITS

Walk over - perfect for foot traffic areas such as paths and steps

Marine-grade stainless steel 316

IP68

Long-lifetime of 70,000hrs

Low power consumption of 1W

350mA or 700mA driver available

PHOTOMETRICS @ 25°C

Product code	Window style	Colour	Beam angle	CRI	350mA		700mA	
					lm	lm/W	lm	lm/W
GL100DX3X40	3 windows	4000K	75°	>80Ra	9	9	11	5
GL100DX3X30	3 windows	3000K	75°	>80Ra	6	6	12	6
GL100DX3X27	3 windows	2700K	75°	>80Ra	6	6	9	5
GL100DX4X40	4 windows	4000K	75°	>80Ra	12	12	14	7
GL100DX4X30	4 windows	3000K	75°	>80Ra	8	8	14	7
GL100DX4X27	4 windows	2700K	75°	>80Ra	8	8	12	6

WIRING INFORMATION

Cable / flying lead	1m (H05RN-F) rubberised cable (outside diameter: 6mm)
Type of wiring required	Series

LED DRIVERS

Product code	Input	SELV	Dimming	Bathroom zone	Min	Max
PLR/350 1-5	220-240V	Yes	No	0	1	5
PLD UNI-DRIVE 350MA	N/A	Yes	Yes (1-10V)	1	1	10
PLU/700 3-9	N/A	Yes	No	1	3	9

ACCESSORIES

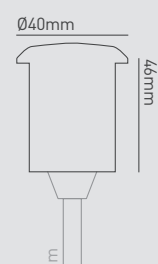
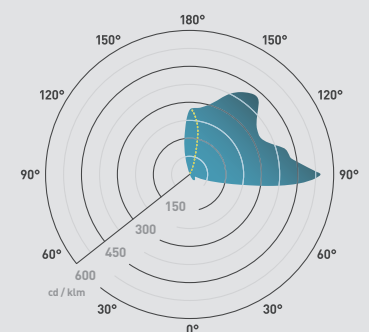

JB2 / JB4 / JB6	IP68 waterproof connectors	Sold separately	422-423
TUBE332	Installation tube	Sold separately	236
PDC/GRID DIMMER	Grid dimmer kit for multiple fitting types	Sold separately	422

Beam angle: 75°



Ground lights.

01604 495 151
collingwoodlighting.com

 @collingwoodLED
 /collingwoodlighting
 collingwoodled

GUARANTEE / WARRANTY

7 year extended warranty

FEATURES & BENEFITS

Straight to mains
Large diameter
Drive over up to 18kN (approx. a 7 ton vehicle) - use with TUBE/68
Marine grade stainless steel 316
Long lifetime of 70,000hrs

Beam angle: 90°

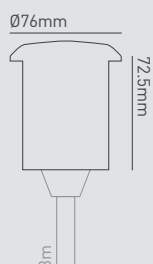
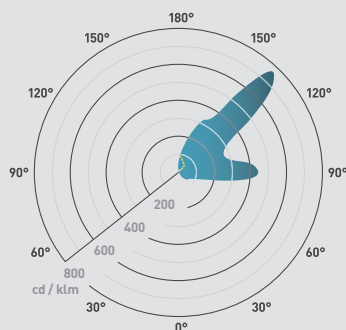

GL200 (1 window - 2 windows)

Large domed marker light

FEATURES

Wattage	5.7W
IP rating	IP67
IK rating	IK10
Colour flexibility	Fixed colour
Walk over / drive over	Drive over (15mph maximum)
Input	Mains AC
LED lifetime	70,000h L70
SDCM	3SDCM

INSTALLATION INFORMATION

Cut out size	Ø 65mm
Bathroom zone	2
Inrush current	31A 0.12ms
Construction material	Stainless steel (316)
Weight	960g
Maximum ambient temperature	35°C
SELV	Yes
Electric class (1, 2, 3)	1

PHOTOMETRICS @ 25°C

Product code	Window style	Colour	Beam angle	CRI	lm	lm/W
GL200DX1X40	1 window	4000K	90°	>80Ra	10	2
GL200DX1X30	1 window	3000K	90°	>80Ra	10	2
GL200DX1X27	1 window	2700K	90°	>80Ra	10	2
GL200DX2140	2 windows, 1 direction	4000K	90°	>80Ra	20	4
GL200DX2130	2 windows, 1 direction	3000K	90°	>80Ra	20	4
GL200DX2127	2 windows, 1 direction	2700K	90°	>80Ra	20	4
GL200DX2240	2 windows, 2 directions	4000K	90°	>80Ra	20	4
GL200DX2230	2 windows, 2 directions	3000K	90°	>80Ra	20	4
GL200DX2227	2 windows, 2 directions	2700K	90°	>80Ra	20	4

WIRING INFORMATION

Cable / flying lead	3m H05RN-F rubberised cable (outside diameter: 7mm)
Type of wiring required	Parallel

LED DRIVERS

Product code	Input	SELV	Dimming	Bathroom zone	Min	Max
N/A (intergrated SELV driver)	220-240V	Yes	No	2	-	-

ACCESSORIES

TUBE/68	Installation tube	Sold separately	236
JB5	Gel filled waterproof connector	Sold separately	423
WC 5-9	Quick waterproof connector	Sold separately	422

Ground lights.

01604 495 151
collingwoodlighting.com

 @collingwoodLED

 /collingwoodlighting

 collingwoodled

GUARANTEE / WARRANTY

7 year extended warranty

FEATURES & BENEFITS

Straight to mains

Large diameter

Drive over up to 18kN (approx. a 7 ton vehicle) - use with TUBE/68

Marine grade stainless steel 316

Long lifetime of 70,000hrs



GL200 (3 windows - 4 windows)

Large domed marker light

FEATURES

Wattage	5.7W
IP rating	IP67
IK rating	IK10
Colour flexibility	Fixed colour
Walk over / drive over	Drive over (15mph maximum)
Input	Mains AC
LED lifetime	70,000h L70
SDCM	3SDCM

INSTALLATION INFORMATION

Cut out size	Ø 65mm
Bathroom zone	2
Inrush current	31A 0.12ms
Construction material	Stainless steel (316)
Weight	960g
Maximum ambient temperature	35°C
SELV	Yes
Electric class [1, 2, 3]	1

PHOTOMETRICS @ 25°C

Product code	Window style	Colour	Beam angle	CRI	lm	lm/W
GL200DX3X40	3 windows	4000K	90°	>80Ra	30	5
GL200DX3X30	3 windows	3000K	90°	>80Ra	30	5
GL200DX3X27	3 windows	2700K	90°	>80Ra	30	5
GL200DX4X40	4 windows	4000K	90°	>80Ra	40	7
GL200DX4X30	4 windows	3000K	90°	>80Ra	40	7
GL200DX4X27	4 windows	2700K	90°	>80Ra	40	7

WIRING INFORMATION

Cable / flying lead	3m H05RN-F rubberised cable (outside diameter: 7mm)
Type of wiring required	Parallel

LED DRIVERS

Product code	Input	SELV	Dimming	Bathroom zone	Min	Max
N/A (intergrated SELV driver)	220-240V	Yes	No	2	-	-

ACCESSORIES

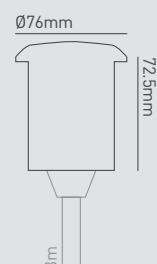
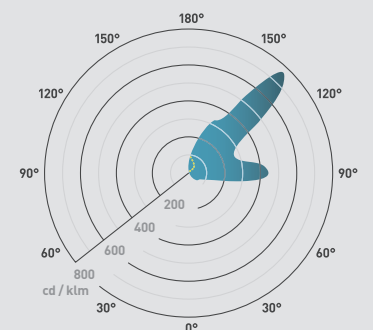

TUBE/68	Installation tube	Sold separately	236
JB5	Gel filled waterproof connector	Sold separately	423
WC 5-9	Quick waterproof connector	Sold separately	422

Beam angle: 90°



Ground lights.

01604 495 151
collingwoodlighting.com

-  @collingwoodLED
-  /collingwoodlighting
-  collingwoodled

GUARANTEE / WARRANTY

7 year extended warranty

FEATURES & BENEFITS

- Frosted effect for softer tone of light
- Robust cable for outdoor use
- Brushed steel finish for sleek effect

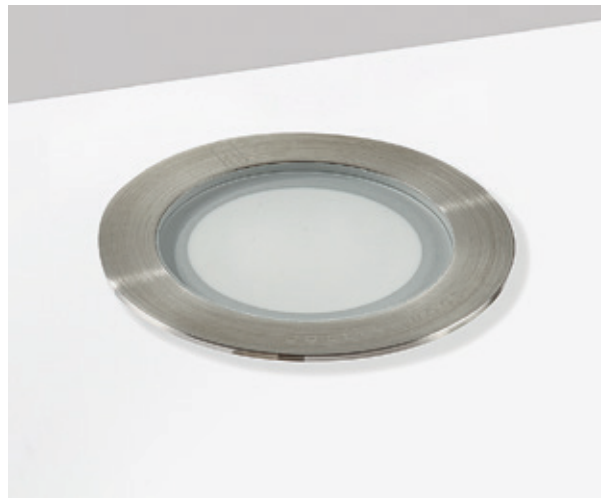

GL050

3W LED ground / marker light

FEATURES

Wattage	3W
IP rating	IP68
IK rating	IK08
Colour flexibility	Fixed colour
Walk over / drive over	Walk over (5mm toughened glass)
Input	350mA
LED lifetime	70,000h L70 B10
SDCM	3SDCM

INSTALLATION INFORMATION

Cut out size	Ø 65mm
Bathroom zone	0
Inrush current	N/A
Construction material	Stainless steel (316)
Weight	552g
Maximum ambient temperature	35°C
SELV	N/A
Electric class (1, 2, 3)	3

PHOTOMETRICS @ 25°C

Product code	Colour	Beam angle	CRI	lm	lm/W	lx at 1m
GL050 NW	4000K	100°	>80Ra	50	17	20
GL050 WW	3000K	100°	>80Ra	46	15	16
GL050 27	2700K	100°	>80Ra	46	15	16
GL050 BLUE	Blue	100°	-	7	2	2

WIRING INFORMATION

Cable / flying lead	1m (H05RN-F) rubberised cable (outside diameter: 6mm)
Type of wiring required	Series

LED DRIVERS

Product code	Input	SELV	Dimming	Bathroom zone	Min	Max
PLU/350 1-9	220-240V	Yes	No	1	1	3
PLR/350 1-5	N/A	Yes	No	0	1	1
PLD UNI-DRIVE 350MA	N/A	Yes	Yes (1-10V)	1	1	3

ACCESSORIES

JB2 / JB4 / JB6	IP68 waterproof connectors	Sold separately	422-423
TUBE/68	Installation tube	Sold separately	236
WCR 275 BLACK	2-core rubber cable	Sold separately	423
PDC/GRID DIMMER	Grid dimmer kit for multiple fitting types	Sold separately	422

Beam angle: 100°

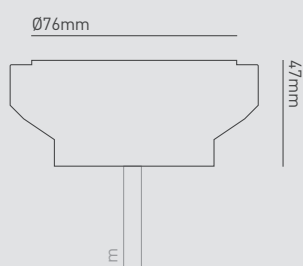
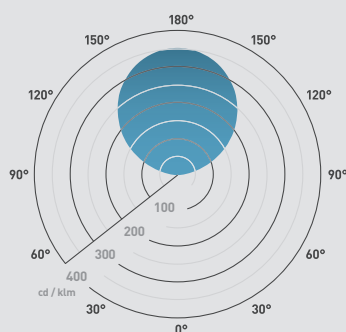

Ground lights.

01604 495 151
collingwoodlighting.com

 @collingwoodLED

 /collingwoodlighting

 collingwoodled

GUARANTEE / WARRANTY

7 year extended warranty

FEATURES & BENEFITS

Frosted effect for softer tone of light

Robust cable for outdoor use

Brushed steel finish for sleek effect

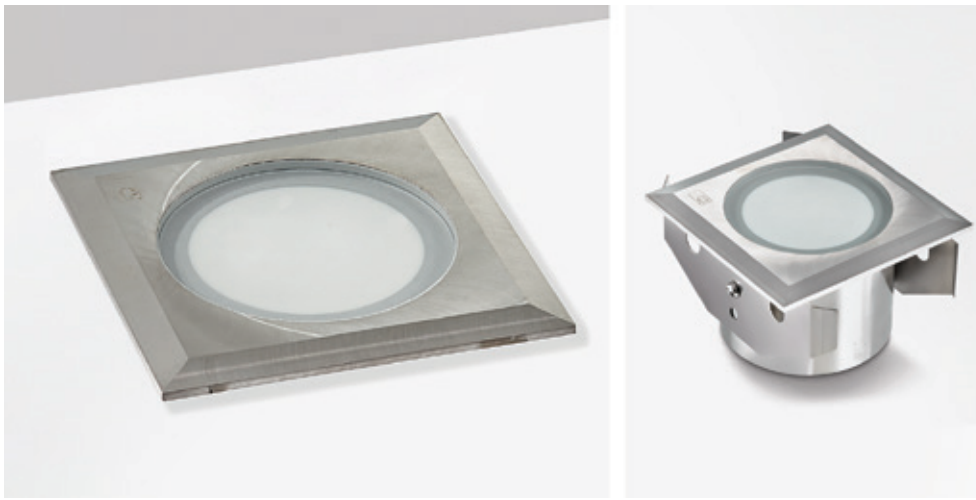

GL051

Square 3W LED ground / marker light

FEATURES

Wattage	3W
IP rating	IP68
IK rating	IK08
Colour flexibility	Fixed colour
Walk over / drive over	Walk over (5mm toughened glass)
Input	350mA
LED lifetime	70,000h L70 B10
SDCM	3SDCM

INSTALLATION INFORMATION

Cut out size	Ø 65mm
Bathroom zone	0
Inrush current	N/A
Construction material	Stainless steel (316)
Weight	600g
Maximum ambient temperature	35°C
SELV	N/A
Electric class [1, 2, 3]	3

PHOTOMETRICS @ 25°C

Product code	Colour	Beam angle	CRI	lm	lm/W	lx at 1m
GL051 NW	4000K	100°	>80Ra	50	17	20
GL051 WW	3000K	100°	>80Ra	46	15	16
GL051 27	2700K	100°	>80Ra	46	15	16
GL051 BLUE	Blue	100°	-	7	2	2

WIRING INFORMATION

Cable / flying lead	1m (H05RN-F) rubberised cable (outside diameter: 6mm)
Type of wiring required	Series

LED DRIVERS

Product code	Input	SELV	Dimming	Bathroom zone	Min	Max
PLU/350 1-9	220-240V	Yes	No	1	1	3
PLR/350 1-5	N/A	Yes	No	0	1	1
PLD UNI-DRIVE 350MA	N/A	Yes	Yes [1-10V]	1	1	3

ACCESSORIES

JB2 / JB4 / JB6	IP68 waterproof connectors	Sold separately	422-423
TUBE/68	Installation tube	Sold separately	236
WCR 275 BLACK	2-core rubber cable	Sold separately	423
PDC/GRID DIMMER	Grid dimmer kit for multiple fitting types	Sold separately	422

Beam angle: 100°

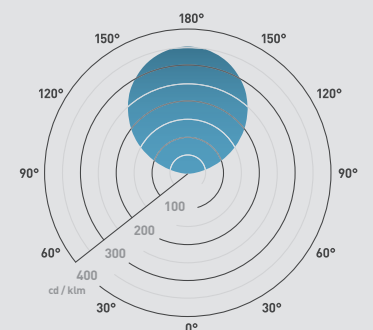

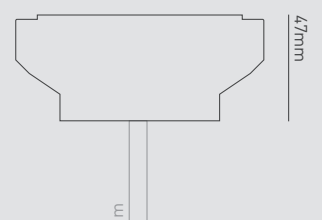

76x76mm



Ground lights.

01604 495 151
collingwoodlighting.com

-  @collingwoodLED
-  /collingwoodlighting
-  collingwoodled

GUARANTEE / WARRANTY

7 year extended warranty

FEATURES & BENEFITS

- Frosted effect for softer tone of light
- Low profile for easy installation
- Robust cable for outdoor use
- Parallel wiring for easier installation and more fittings to a power supply

Beam angle: 120°

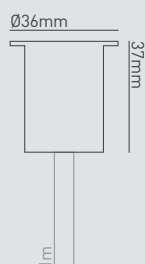
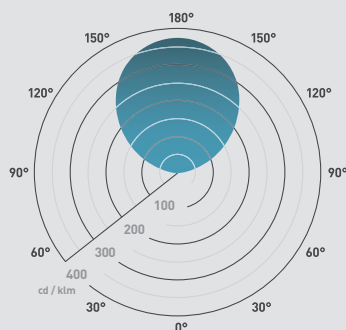

GL018 C

Small LED marker light

FEATURES

Wattage	0.5W
IP rating	IP68
IK rating	IK07
Colour flexibility	Fixed colour
Walk over / drive over	Walk over (5mm toughened glass)
Input	24V DC
LED lifetime	30,000h
SDCM	3SDCM

INSTALLATION INFORMATION

Cut out size	Ø 28mm
Bathroom zone	0
Inrush current	N/A
Construction material	Stainless steel (316)
Weight	300g
Maximum ambient temperature	35°C
SELV	N/A
Electric class (1, 2, 3)	3

PHOTOMETRICS @ 25°C

Product code	Colour	Beam angle	CRI	lm	lm/W	lx at 1m
GL018 C NW	4000K	120°	>70Ra	3	6	1
GL018 C WW	3000K	120°	>80Ra	3	6	1
GL018 C 27	2700K	120°	>80Ra	3	6	1
GL018 C AMBER	Amber	120°	-	-	-	-
GL018 C BLUE	Blue	120°	-	1	2	1
GL018 C GREEN	Green	120°	-	-	-	-
GL018 C RED	Red	120°	-	-	-	-

WIRING INFORMATION

Cable / flying lead	1m (H05RN-F) rubberised cable (outside diameter: 6mm)
Type of wiring required	Parallel

LED DRIVERS

Product code	Input	SELV	Dimming	Bathroom zone	Min	Max
PS1524	220-240V	Yes	Yes (PDCINT1-10V)	0 (1 when dimming)	1	30
PS5024	N/A	Yes	Yes (PDCINT1-10V)	0 (1 when dimming)	1	100
PSDIP10024	N/A	Yes	Yes (1-10V)	0 (1 when dimming)	1	200



ACCESSORIES

JB1 / JB5 / JB6	IP68 waterproof connectors	Sold separately	422-423
PDC/GRID DIMMER	Grid dimmer kit for multiple fitting types	Sold separately	422
PDCINT1-10V	1-10V dimming interface for use with 24V LED drivers	Sold separately	412



Ground lights.

01604 495 151
collingwoodlighting.com

-  @collingwoodLED
-  /collingwoodlighting
-  collingwoodled

GL018 C AB

Small antique brass LED marker light

FEATURES

Wattage	0.5W
IP rating	IP68
IK rating	IK07
Colour flexibility	Fixed colour
Walk over / drive over	Walk over (5mm toughened glass)
Input	24V DC
LED lifetime	30,000h
SDCM	3SDCM

INSTALLATION INFORMATION

Cut out size	Ø 28mm
Bathroom zone	0
Inrush current	N/A
Construction material	Brass
Weight	300g
Maximum ambient temperature	35°C
SELV	N/A
Electric class [1, 2, 3]	3

GUARANTEE / WARRANTY

7 year extended warranty

FEATURES & BENEFITS

- Frosted effect for softer tone of light
- Robust cable for outdoor use
- Shallow depth for easy installation
- Solid brass for antique effect
- Parallel wiring for easier installation and more fittings to a power supply

PHOTOMETRICS @ 25°C

Product code	Colour	Beam angle	CRI	lm	lm/W	lx at 1m
GL018 C AB NW	4000K	120°	>70Ra	3	6	1
GL018 C AB WW	3000K	120°	>80Ra	3	6	1
GL018 C AB 27	2700K	120°	>80Ra	3	6	1
GL018 C AB AMBER	Amber	120°	-	-	-	-
GL018 C AB BLUE	Blue	120°	-	-	-	-
GL018 C AB GREEN	Green	120°	-	-	-	-
GL018 C AB RED	Red	120°	-	-	-	-

WIRING INFORMATION

Cable / flying lead	1m (H05RN-F) rubberised cable (outside diameter: 6mm)
Type of wiring required	Parallel

LED DRIVERS

Product code	Input	SELV	Dimming	Bathroom zone	Min	Max
PS1524	220-240V	Yes	Yes (PDCINT1-10V)	0 (1 when dimming)	1	30
PS5024	N/A	Yes	Yes (PDCINT1-10V)	0 (1 when dimming)	1	100
PSDIP10024	N/A	Yes	Yes (1-10V)	0 (1 when dimming)	1	200

ACCESSORIES

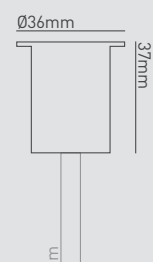
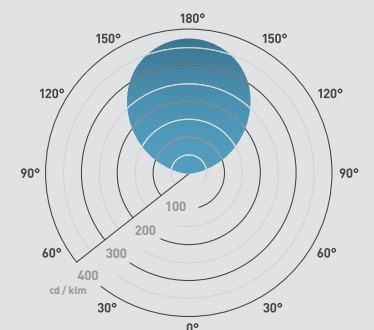

JB1 / JB5 / JB6	IP68 waterproof connectors	Sold separately	422-423
PDC/GRID DIMMER	Grid dimmer kit for multiple fitting types	Sold separately	422
PDCINT1-10V	1-10V dimming interface for use with 24V LED drivers	Sold separately	412

Beam angle: 120°



Ground lights.

01604 495 151
collingwoodlighting.com

-  @collingwoodLED
-  /collingwoodlighting
-  collingwoodled

GUARANTEE / WARRANTY

7 year extended warranty

FEATURES & BENEFITS

- Frosted effect for softer tone of light
- Low profile for easy installation
- Robust cable for outdoor use
- Square fascia for a different decorative effect
- Parallel wiring for easier installation and more fittings to a power supply

Beam angle: 120°

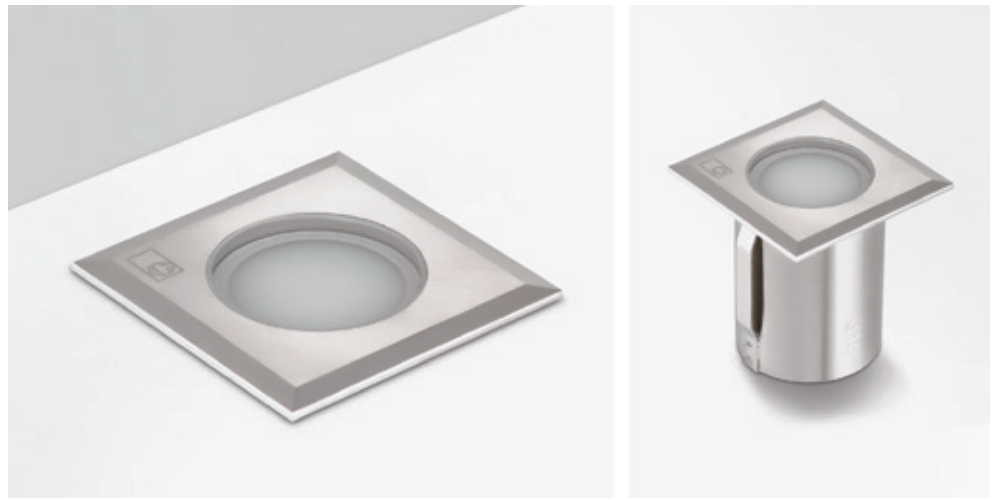
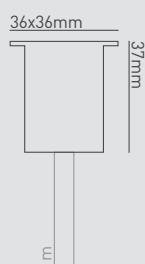
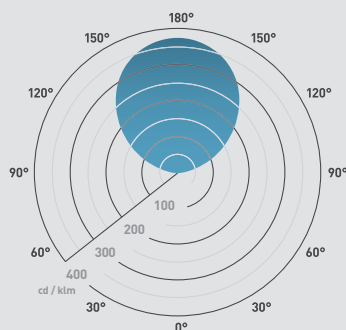

GL018 SQ

Small square LED marker light

FEATURES

Wattage	0.5W
IP rating	IP68
IK rating	IK07
Colour flexibility	Fixed colour
Walk over / drive over	Walk over (5mm toughened glass)
Input	24V DC
LED lifetime	30,000h
SDCM	3SDCM

INSTALLATION INFORMATION

Cut out size	Ø 28mm
Bathroom zone	0
Inrush current	N/A
Construction material	Stainless steel (316)
Weight	300g
Maximum ambient temperature	35°C
SELV	N/A
Electric class (1, 2, 3)	3

PHOTOMETRICS @ 25°C

Product code	Colour	Beam angle	CRI	lm	lm/W	lx at 1m
GL018 SQ NW	4000K	120°	>70Ra	3	6	1
GL018 SQ WW	3000K	120°	>80Ra	3	6	1
GL018 SQ 27	2700K	120°	>80Ra	3	6	1
GL018 SQ BLUE	Blue	120°	-	-	-	-

WIRING INFORMATION

Cable / flying lead	1m (H05RN-F) rubberised cable (outside diameter: 6mm)
Type of wiring required	Parallel

LED DRIVERS



Product code	Input	SELV	Dimming	Bathroom zone	Min	Max
PS1524	220-240V	Yes	Yes (PDCINT1-10V)	0 (1 when dimming)	1	30
PS5024	N/A	Yes	Yes (PDCINT1-10V)	0 (1 when dimming)	1	100
PSDIP10024	N/A	Yes	Yes (1-10V)	0 (1 when dimming)	1	200

ACCESSORIES

JB1 / JB5 / JB6	IP68 waterproof connectors	Sold separately	422-423
PDC/GRID DIMMER	Grid dimmer kit for multiple fitting types	Sold separately	422
PDCINT1-10V	1-10V dimming interface for use with 24V LED drivers	Sold separately	412

Ground lights.

01604 495 151
collingwoodlighting.com

-  @collingwoodLED
-  /collingwoodlighting
-  collingwoodled

GUARANTEE / WARRANTY

7 year extended warranty

FEATURES & BENEFITS

- Frosted effect for softer tone of light
- Incorporated thread and nut for secure fitting into panels, walls or ceilings
- Robust cable for outdoor use
- Parallel wiring for easier installation and more fittings to a power supply



GL018 T

Small panel mount LED marker light

FEATURES

Wattage	0.5W
IP rating	IP68
IK rating	IK07
Colour flexibility	Fixed colour
Walk over / drive over	Walk over (5mm toughened glass)
Input	24V DC
LED lifetime	30,000h
SDCM	3SDCM

INSTALLATION INFORMATION

Cut out size	Ø 28mm
Bathroom zone	0
Inrush current	N/A
Construction material	Stainless steel (316)
Weight	300g
Maximum ambient temperature	35°C
SELV	N/A
Electric class [1, 2, 3]	3

PHOTOMETRICS @ 25°C

Product code	Colour	Beam angle	CRI	lm	lm/W	lx at 1m
GL018 T NW	4000K	120°	>70Ra	3	6	1
GL018 T BLUE	Blue	120°	-	-	-	-

WIRING INFORMATION

Cable / flying lead	1m (H05RN-F) rubberised cable (outside diameter: 6mm)
Type of wiring required	Parallel

LED DRIVERS

Product code	Input	SELV	Dimming	Bathroom zone	Min	Max
PS1524	220-240V	Yes	Yes (PDCINT1-10V)	0 (1 when dimming)	1	30
PS5024	N/A	Yes	Yes (PDCINT1-10V)	0 (1 when dimming)	1	100
PSDIP10024	N/A	Yes	Yes (1-10V)	0 (1 when dimming)	1	200

ACCESSORIES

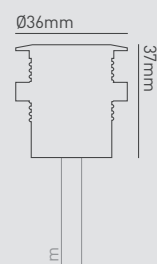
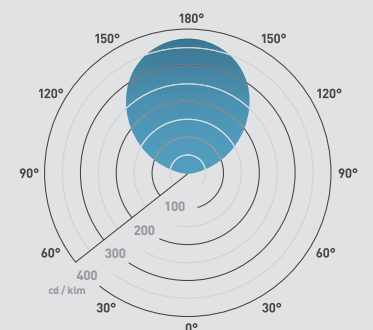

JB1 / JB5 / JB6	IP68 waterproof connectors	Sold separately	422-423
PDC/GRID DIMMER	Grid dimmer kit for multiple fitting types	Sold separately	422
PDCINT1-10V	1-10V dimming interface for use with 24V LED drivers	Sold separately	412

Beam angle: 120°



Ground lights.

01604 495 151
collingwoodlighting.com

-  @collingwoodLED
-  /collingwoodlighting
-  collingwoodled

GUARANTEE / WARRANTY

1 year guarantee

FEATURES & BENEFITS

- Use in concrete as shutter / formwork
- Use in slabs to retain soil / sand

TUBE332



Ø37mm

TUBE/50



Ø56mm

TUBE/68

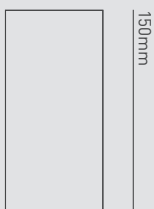

Ø72mm

236



TUBE332 | TUBE/50 | TUBE/68

Installation tubes

INSTALLATION INFORMATION

Construction material	Anodised aluminium
Weight	TUBE332 - 142g TUBE/50 - 252g TUBE/68 - 362g

PRODUCT CODES

Product codes	Description
TUBE332	Ground light installation tube
TUBE/50	Ground light installation tube
TUBE/68	Ground light installation tube

USE WITH

TUBE332	TUBE/50	TUBE/68
GL019	GL016	GL040
GL019 Ultra low glare	GL016FAB	GL040 Ultra low glare
GL019LG	GL016RGBW	GL040CARGB
GL019SQ	GL016SQ	GL041
GL019 Frosted	GL016 Frosted	GL050
GL100	GL021	GL050RGBW
	GL022	GL051
		GL090
		GL090RGBW
		GL063
		GL064
		GL200

Ground lights.

01604 495 151
collingwoodlighting.com

 @collingwoodLED

 /collingwoodlighting

 collingwoodled

GUARANTEE / WARRANTY

7 year extended warranty

FEATURES & BENEFITS

Marine grade stainless steel 316

Transform round ground lights to square ground lights



GLA01

Square transformer plate for ground lights

INSTALLATION INFORMATION

Construction material	Stainless steel (316)
Weight	165g

PRODUCT CODES

Product codes	Description
GLA01	Ground Light Accessory, square plate, stainless steel 316, 65mm cut-out

USE WITH

GL040	LED ground light with single point source lens
GL040CARGB	Colour change LED ground light (3.5W max.)
GL040 Ultra low-glare	2W LED ground light
GL050	3W LED ground / marker light
GL050RGBW	Colour change LED ground / marker light (5W max.)
GL090	7W LED ground light
GL090RGBW	High output LED colour change ground light (12W max.)

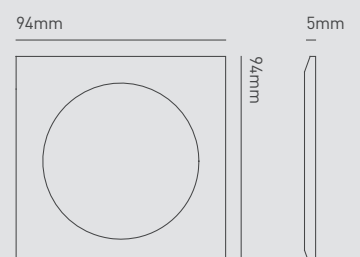

Step lighting.

Functional and decorative

Step lights are the perfect solution for highlighting stairs and pathways.

They are both functional and decorative whilst highlighting a potentially hazardous area in the dark.

Functional step lighting

Using lighting to highlight steps improves visual aesthetics and enhances safety, whilst adding an inviting glow to your space.

Considerations should be made for maintenance and glare when positioning lighting, ensuring ultimate visual appeal and added security knowing the walkway is correctly lit.



Low glare step lighting

The purpose of step lighting is to mark or highlight a particular area. As this type of lighting serves a functional purpose, it is important that the fittings do not cause any visual discomfort from glare.

Hooded

Using a hood over the light will restrict upwards light spill. This results in low visibility of the light source from above and will prevent glare to passers-by.



Asymmetric

An asymmetric light source will direct the light downwards, ensuring the stairway is illuminated without upwards glare, without the need of a hood. Eliminating the need for a hood allows these lights to also be used as ground lights.



Decorative step lighting

Step lights can be used to enhance your landscape, to amplify your overall lighting when entertaining and for commercial exterior lighting. Linking people and spaces together, highlighting steps can make a real difference.

Choose Collingwood's range of decorative step lighting which emit light from a decorative face-plate to transform your overall lighting design.



Round and square fittings

Choose between round and square fittings to achieve the ideal style for your installation.

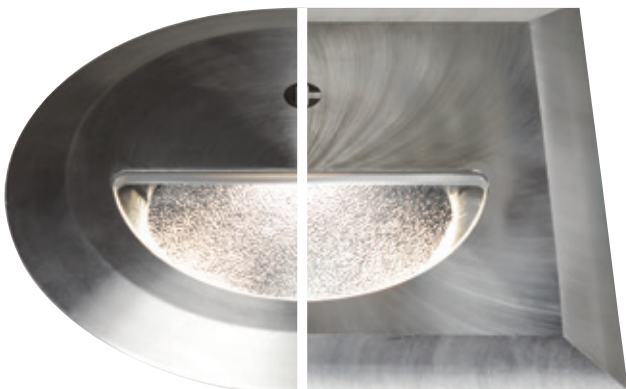



Highlight features as a ground light

The asymmetric beam of step lights makes them great for using as a ground light that directs its light onto a feature.



Step lights.

01604 495 151
collingwoodlighting.com

-  @collingwoodLED
-  /collingwoodlighting
-  collingwoodled

GUARANTEE / WARRANTY

7 year extended warranty

FEATURES & BENEFITS

Recessed, asymmetric wall or ground light perfect for illuminating walls, steps and pathways

Straight to mains for easy retrofit

Available in rustic cast stainless steel and sleek brushed stainless steel finishes

Installation tube included



WL339

Asymmetric, straight to mains, cast finish step light

FEATURES

Wattage	2.6W
IP rating	IP67
IK rating	N/A
Colour flexibility	Fixed colour
Walk over / drive over	Walk over
Input	Mains AC
LED lifetime	70,000h L70 B10
SDCM	3SDCM

INSTALLATION INFORMATION

Cut out size	Ø 80mm
Bathroom zone	2
Inrush current	9A 0.8ms
Construction material	Stainless steel (316)
Weight	1000g
Maximum ambient temperature	35°C
SELV	Yes
Electric class (1, 2, 3)	1

PHOTOMETRICS @ 25°C

Product code	Colour	Beam angle	CRI	lm	lm/W	lx at 1m
WL339NW	4000K	50°	>70Ra	59	22	65
WL339WW	3000K	50°	>80Ra	50	19	54
WL33927	2700K	50°	>80Ra	49	19	52

WIRING INFORMATION

Cable / flying lead	1m (H05RN-F) rubberised cable (outside diameter: 7mm)
Type of wiring required	Parallel

LED DRIVERS

Product code	Input	SELV	Dimming	Bathroom zone	Min	Max
N/A (integrated SELV driver)	220-240V	Yes	No	2	-	-

ACCESSORIES

Installation tube	Included	236
JB5	Gel filled waterproof connector	Sold separately 423
WC 5-9	Quick release waterproof joint	Sold separately 422

Plane: 50° C0/C180 50° C90/C270

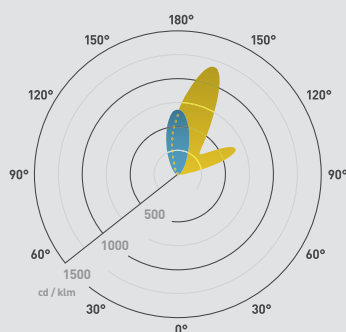

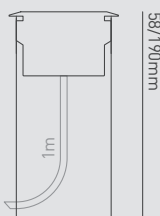

Ø98mm



Step lights.

01604 495 151
collingwoodlighting.com

 @collingwoodLED

 /collingwoodlighting

 collingwoodled

GUARANTEE / WARRANTY

7 year extended warranty

FEATURES & BENEFITS

Recessed, asymmetric wall or ground light perfect for illuminating walls, steps and pathways

Straight to mains for easy retrofit

Available in rustic cast stainless steel and sleek brushed stainless steel finishes

Installation tube included



WL340

Asymmetric, straight to mains, brush finish step light

FEATURES

Wattage	2.6W
IP rating	IP67
IK rating	N/A
Colour flexibility	Fixed colour
Walk over / drive over	Walk over
Input	Mains AC
LED lifetime	70,000h L70 B10
SDCM	3SDCM

INSTALLATION INFORMATION

Cut out size	Ø 80mm
Bathroom zone	2
Inrush current	9A 0.8ms
Construction material	Stainless steel (316)
Weight	1000g
Maximum ambient temperature	35°C
SELV	Yes
Electric class [1, 2, 3]	1

PHOTOMETRICS @ 25°C

Product code	Colour	Beam angle	CRI	lm	lm/W	lx at 1m
WL340NW	4000K	50°	>70Ra	59	22	65
WL340WW	3000K	50°	>80Ra	50	19	54
WL34027	2700K	50°	>80Ra	49	19	52

WIRING INFORMATION

Cable / flying lead	1m (H05RN-F) rubberised cable (outside diameter: 7mm)
Type of wiring required	Parallel

LED DRIVERS

Product code	Input	SELV	Dimming	Bathroom zone	Min	Max
N/A (integrated SELV driver)	220-240V	-	No	2	-	-

ACCESSORIES

Installation tube	Included	236
JB5	Gel filled waterproof connector	Sold separately 423
WC 5-9	Quick release waterproof joint	Sold separately 422

Plane: 50° C0/C180 50° C90/C270

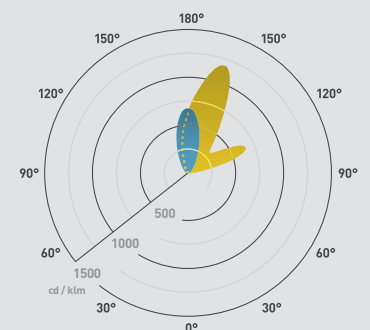

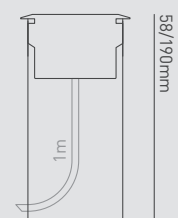

Ø98mm



Step lights.

01604 495 151
collingwoodlighting.com

-  @collingwoodLED
 /collingwoodlighting
 collingwoodled

GUARANTEE / WARRANTY

7 year extended warranty

FEATURES & BENEFITS

- Can be used as a wall light or ground light
- Straight to mains for easy installation
- Installation tube included
- 1m H05RN-F rubber cable attached for permanent use outdoors

Plane: 50° C0/C180 50° C90/C270

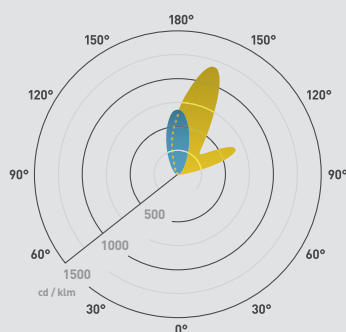

98x98mm

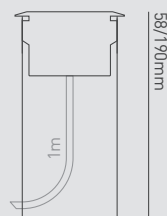

WL341

Asymmetric, straight to mains, cast finish step light

FEATURES

Wattage	2.6W
IP rating	IP67
IK rating	N/A
Colour flexibility	Fixed colour
Walk over / drive over	Walk over
Input	Mains AC
LED lifetime	70,000h L70 B10
SDCM	3SDCM

INSTALLATION INFORMATION

Cut out size	Ø 80mm
Bathroom zone	2
Inrush current	9A 0.8ms
Construction material	Stainless steel (316)
Weight	1000g
Maximum ambient temperature	35°C
SELV	Yes
Electric class (1, 2, 3)	1

PHOTOMETRICS @ 25°C

Product code	Colour	Beam angle	CRI	lm	lm/W	lx at 1m
WL341NW	4000K	50°	>70Ra	59	22	65
WL341WW	3000K	50°	>80Ra	50	19	54
WL34127	2700K	50°	>80Ra	49	19	52

WIRING INFORMATION

Cable / flying lead	1m (H05RN-F) rubberised cable (outside diameter: 7mm)
Type of wiring required	Parallel

LED DRIVERS



Product code	Input	SELV	Dimming	Bathroom zone	Min	Max
N/A (integrated SELV driver)	220-240V	-	No	2	-	-

ACCESSORIES

Installation tube	Included	236
JB5	Gel filled waterproof connector	Sold separately 423
WC 5-9	Quick release waterproof joint	Sold separately 422

Step lights.

01604 495 151
collingwoodlighting.com

-  @collingwoodLED
-  /collingwoodlighting
-  collingwoodled

GUARANTEE / WARRANTY

7 year extended warranty

FEATURES & BENEFITS

- Can be used as a wall light or ground light
- Straight to mains for easy installation
- Installation tube included
- 1m H05RN-F rubber cable attached for permanent use outdoors



WL342

Asymmetric, straight to mains, brush finish step light

FEATURES

Wattage	2.6W
IP rating	IP67
IK rating	N/A
Colour flexibility	Fixed colour
Walk over / drive over	Walk over
Input	Mains AC
LED lifetime	70,000h L70 B10
SDCM	3SDCM

INSTALLATION INFORMATION

Cut out size	Ø 80mm
Bathroom zone	2
Inrush current	9A 0.8ms
Construction material	Stainless steel (316)
Weight	1000g
Maximum ambient temperature	35°C
SELV	Yes
Electric class [1, 2, 3]	1

PHOTOMETRICS @ 25°C

Product code	Colour	Beam angle	CRI	lm	lm/W	lx at 1m
WL342NW	4000K	50°	>70Ra	59	22	65
WL342WW	3000K	50°	>80Ra	50	19	54
WL34227	2700K	50°	>80Ra	49	19	52

WIRING INFORMATION

Cable / flying lead	1m (H05RN-F) rubberised cable (outside diameter: 7mm)
Type of wiring required	Parallel

LED DRIVERS

Product code	Input	SELV	Dimming	Bathroom zone	Min	Max
N/A (integrated SELV driver)	220-240V	-	No	2	-	-

ACCESSORIES

Installation tube	Included	236
JB5	Gel filled waterproof connector	Sold separately 423
WC 5-9	Quick release waterproof joint	Sold separately 422

Plane: 50° C0/C180 50° C90/C270

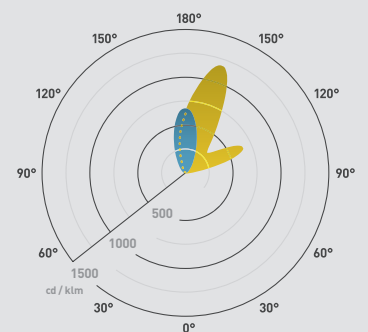

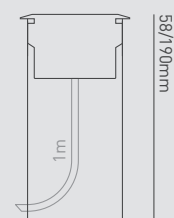

98x98mm



Step lights.

01604 495 151
collingwoodlighting.com

 @collingwoodLED

 /collingwoodlighting

 collingwoodled

GUARANTEE / WARRANTY

7 year extended warranty

FEATURES & BENEFITS

Angled light, ideal for use as a step light

Robust cable for outdoor use

Brushed stainless steel for sleek effect



GL021

30° slotted LED ground / step light

FEATURES

Wattage	1W
IP rating	IP68
IK rating	IK07
Colour flexibility	Fixed colour
Walk over / drive over	Walk over (5mm toughened glass)
Input	350mA
LED lifetime	70,000h L70 B10
SDCM	3SDCM

INSTALLATION INFORMATION

Cut out size	Ø 50mm
Bathroom zone	0
Inrush current	N/A
Construction material	Stainless steel (316)
Weight	400g
Maximum ambient temperature	35°C
SELV	N/A
Electric class (1, 2, 3)	3

PHOTOMETRICS @ 25°C

Product code	Colour	Beam angle	CRI	lm	lm/W	lx at 1m
GL021 NW	4000K	30°	>80Ra	10	10	10
GL021 WW	3000K	30°	>80Ra	8	8	8
GL021 27	2700K	30°	>80Ra	8	8	7
GL021 BLUE	Blue	30°	-	-	-	-

WIRING INFORMATION

Cable / flying lead	1m (H05RN-F) rubberised cable (outside diameter: 6mm)
Type of wiring required	Series

LED DRIVERS

Product code	Input	SELV	Dimming	Bathroom zone	Min	Max
PLU/350 1-9	220-240V	Yes	No	1	1	9
PLR/350 1-5	220-240V	Yes	No	0	1	5
PLD UNI-DRIVE 350MA	220-240V	Yes	Yes (1-10V)	2	1	10

ACCESSORIES

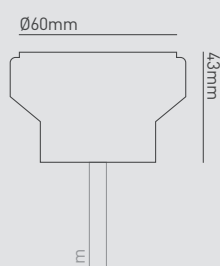
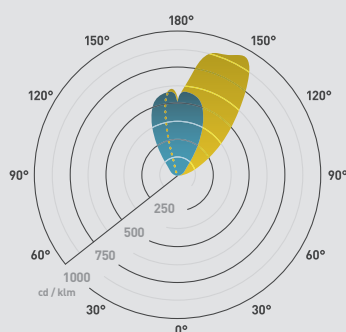

JB2 / JB4 / JB6	IP68 waterproof connectors	Sold separately	422-423
TUBE/50	Installation tube	Sold separately	236
WCR 275 BLACK	2-core rubber cable	Sold separately	423
PDC/GRID DIMMER	Grid dimmer kit for multiple fitting types	Sold separately	422

Plane: C0/C180 C90/C270



Step lights.

01604 495 151
collingwoodlighting.com

-  @collingwoodLED
-  /collingwoodlighting
-  collingwoodled

GUARANTEE / WARRANTY

7 year extended warranty

FEATURES & BENEFITS

- Angled light, ideal for use as a step light
- Cast stainless steel for aged effect
- Robust cable for outdoor use



GL022

Square 30° slotted LED ground / step light

FEATURES

Wattage	1W
IP rating	IP68
IK rating	IK07
Colour flexibility	Fixed colour
Walk over / drive over	Walk over (5mm toughened glass)
Input	350mA
LED lifetime	70,000h L70 B10
SDCM	3SDCM

INSTALLATION INFORMATION

Cut out size	Ø 50mm
Bathroom zone	0
Inrush current	N/A
Construction material	Stainless steel (316)
Weight	400g
Maximum ambient temperature	35°C
SELV	N/A
Electric class [1, 2, 3]	3

PHOTOMETRICS @ 25°C

Product code	Colour	Beam angle	CRI	lm	lm/W	lx at 1m
GL022 NW	4000K	30°	>80Ra	10	10	10
GL022 WW	3000K	30°	>80Ra	8	8	8
GL022 27	2700K	30°	>80Ra	8	8	7
GL022 BLUE	Blue	30°	-	-	-	-

WIRING INFORMATION

Cable / flying lead	1m (H05RN-F) rubberised cable (outside diameter: 6mm)
Type of wiring required	Series

LED DRIVERS

Product code	Input	SELV	Dimming	Bathroom zone	Min	Max
PLU/350 1-9	220-240V	Yes	No	1	1	9
PLR/350 1-5	220-240V	Yes	No	0	1	5
PLD UNI-DRIVE 350MA	220-240V	Yes	Yes [1-10V]	2	1	10

ACCESSORIES

JB2 / JB4 / JB6	IP68 waterproof connectors	Sold separately	422-423
TUBE/50	Installation tube	Sold separately	236
WCR 275 BLACK	2-core rubber cable	Sold separately	423
PDC/GRID DIMMER	Grid dimmer kit for multiple fitting types	Sold separately	422

Plane: C0/C180 C90/C270

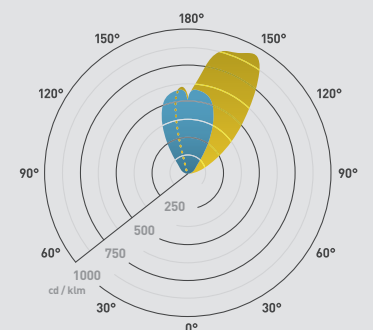

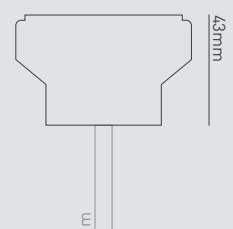

60x60mm



Step lights.

01604 495 151
collingwoodlighting.com

 @collingwoodLED
 /collingwoodlighting
 collingwoodled

GUARANTEE / WARRANTY

7 year extended warranty

FEATURES & BENEFITS

Improved look and feel with single LED
Straight to mains
Marine grade stainless steel 316
Long lifetime of 70,000hrs

Beam angle: 40°

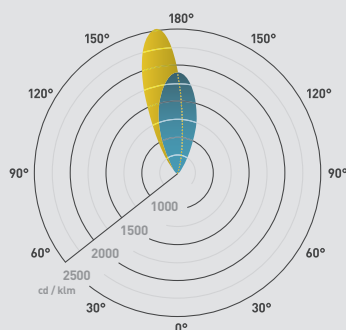

Ø98mm

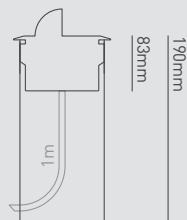

GL034

Hooded LED ground light

FEATURES

Wattage	2.9W
IP rating	IP67
IK rating	IK08
Colour flexibility	Fixed colour
Walk over / drive over	Walk over (5mm toughened glass)
Input	Mains AC
LED lifetime	70,000h L70 B10
SDCM	3SDCM

INSTALLATION INFORMATION

Cut out size	Ø 80-85mm
Bathroom zone	2
Inrush current	60A 0.037ms
Construction material	Stainless steel 316 (top) / Aluminium (body)
Weight	724g
Maximum ambient temperature	35°C
SELV	Yes
Electric class (1, 2, 3)	1

PHOTOMETRICS @ 25°C

Product code	Colour	Beam angle	CRI	lm	lm/W	lx at 1m
GL034DWBM40	4000K	40°	>80Ra	190	66	357
GL034DWBM30	3000K	40°	>80Ra	180	62	338
GL034DWBM27	2700K	40°	>80Ra	170	59	320

WIRING INFORMATION

Cable / flying lead	1m H05RN-F rubberised cable (outside diameter: 7mm)
Type of wiring required	Parallel

LED DRIVERS

Product code	Input	SELV	Dimming	Bathroom zone	Min	Max
N/A (integrated SELV driver)	220-240V	Yes	No	2	-	-

ACCESSORIES

Installation tube	Included	236
JB5	Gel filled waterproof connector	Sold separately 423
WC 5-9	Quick release waterproof joint	Sold separately 422



Wall lights.

To create secure and adventurous spaces

Wall lights provide security as well as atmospheric and decorative lighting. Available in a range of styles and finishes, choose the perfect solution for your installation.

Choose your effect and how to create it

Highlight architecture or illuminate an entrance with Collingwood wall lights. The images below illustrate how your choice of lighting creates different effects.

Choose your effect:

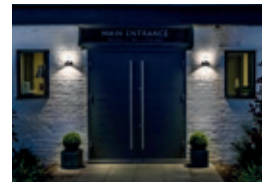

Create it using:



WL070A

This up / down light produces a narrow and concentrated beam of light up and downwards. This is used most effectively in situations where there is a great deal of height to fully appreciate the effect of the columns of light. As a result, these fittings are great for framing doors and windows.

WL075A

The narrow and intense beam of light from this fitting will enhance the texture of the surface upon which it is mounted. This product works well on uneven stone and provides plenty of contrast between areas of light and shade.

MC050

This product perfectly combines practicality and drama. The wide-angle, downwards beam lights a broad area, while the narrow flume of uplight creates visual interest and a touch of glamour.

MC040

This clean and contemporary fitting provides a broad spread of light, which is great for lighting the threshold of any doorway. This product is also useful for providing general illumination and highlighting plant features.

WL060

This fitting provides a diffused decorative light from its top and a broad spread of down light which will light the threshold of a doorway. This fitting will also ensure both comfort and safety are accommodated in addition to highlighting any decorative planting positioned below.

 Check out our wall light comparison video on the Collingwood Lighting YouTube channel or call 01604 495 151 to speak to our design team.

Premium finishes

Available in a range of stylish finishes such as anodised aluminium and copper, our powerful WL220 wall lights also sport an attractive single point source LED, maximising the look and feel of the luminaires without compromising on performance.

Alongside our ultra-premium solid copper finish, we've updated our range to include stainless steel 316 and anodised bronze, giving you even more choice when designing your installation.



WL220B

WL220C

WL220D

WL220Z

Framing vs. feature lighting

With several styles and finishes available, we have the solution that creates the perfect lighting effect for your installation. Types of light effects to consider are:

Wall grazing



WL175A

A direct to mains LED wall light that is suitable for decorating walls, pillars or posts with floods of light.

Directional



WL220

Creating an effect that is both modern and elegant, this product can be rotated against a wall to select any angle of light as required, bringing that wow factor to any space.

Decorative



WL041IP

Over one hundred tiny fins produce large blades of light across walls and ceilings in a dramatic fashion. This decorative wall light is a must for any striking lighting scheme.

Low glare hoods and snoots

Upgrade the look and feel of your wall light installation with a simple low glare hood or snoot accessory. The accessories minimise any 'spill light' from the product to create a crisp beam of light which is low glare.

Standard wall light

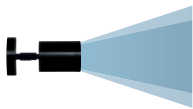

Flexible wall lighting with a high-quality fixture. Without using an accessory the beam of light has a soft halo around the measured beam angle.

Low glare hood



A simple solution to create discreet lighting whilst optimising the light distribution. The widest part of the hood reduces the spill light from one side of the light.

Low glare snoot



This cylindrical snoot accentuates the style factor. Perfect for creating a moonlight effect the snoot reduces the spill light in all directions.

Height of wall lights

A general rule of choosing the correct height and position for wall lights is 1650mm from floor or ground level (eye level to a person of 5ft 8in height.)

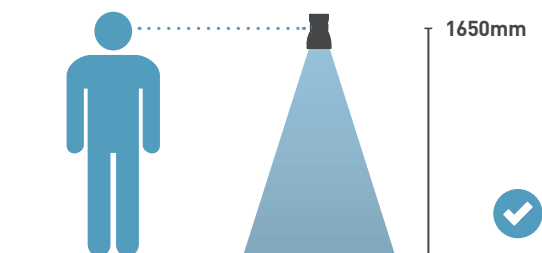

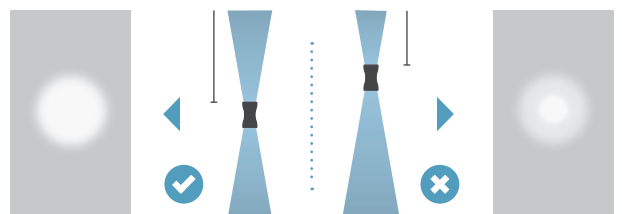

Light positioning

To avoid hot spots when using up/down lights to frame doors and windows, ensure that they are not positioned too closely to the ceiling or other horizontal surfaces.



Wall lights.

01604 495 151
collingwoodlighting.com

-  @collingwoodLED
-  /collingwoodlighting
-  collingwoodled

GUARANTEE / WARRANTY

7 year extended warranty

FEATURES & BENEFITS

Improved look and feel with single LED

Bi-directional, straight to mains wall light, perfect for framing entrances and illuminating columns

Solid copper option gradually ages over time to offer a wonderful antique effect

Long lifetime of 70,000hrs



WL070

Straight to mains, high output LED wall light

FEATURES

Wattage	5.1W
IP rating	IP65
Colour flexibility	Fixed colour
Tiltable	No
Rotatable	No
Dimmable	No
Input	Mains AC
LED lifetime	70,000h L70 B10
SDCM	3SDCM

INSTALLATION INFORMATION

Bathroom zone	2
Inrush current	60A 0.037ms
Construction material	Anodised aluminium
Weight	0.9kg
Maximum ambient temperature	40°C
SELV	Yes
Electric class [1, 2, 3]	1

PHOTOMETRICS @ 25°C

Product code	Finish	Colour	Beam angle	CRI	lm	lm/W	lx at 1m
WL070BNBM40	Black	4000K	12°	>80Ra	560 / 280	110	3455 / 1727
WL070BNBM30	Black	3000K	12°	>80Ra	550 / 275	108	3394 / 1697
WL070BNBM27	Black	2700K	12°	>80Ra	510 / 255	100	3147 / 1573
WL070ZNBM40	Bronze	4000K	12°	>80Ra	560 / 280	110	3455 / 1727
WL070ZNBM30	Bronze	3000K	12°	>80Ra	550 / 275	108	3394 / 1697
WL070ZNBM27	Bronze	2700K	12°	>80Ra	510 / 255	100	3147 / 1573
WL070CNBM30	Copper	3000K	12°	>80Ra	550 / 275	108	3394 / 1697
WL070CNBM27	Copper	2700K	12°	>80Ra	510 / 255	100	3147 / 1573
WL070SNBM40	Silver	4000K	12°	>80Ra	560 / 280	110	3455 / 1727
WL070SNBM30	Silver	3000K	12°	>80Ra	550 / 275	108	3394 / 1697
WL070SNBM27	Silver	2700K	12°	>80Ra	510 / 255	100	3147 / 1573

WIRING INFORMATION

Cable / flying lead	0.3m
Type of wiring required	Parallel

LED DRIVERS

Product code	Input	SELV	Dimming	Bathroom zone	Min	Max
N/A (integrated SELV driver)	220-240V	Yes	No	N/A	N/A	N/A

ACCESSORIES

N/A	No accessories required
-----	-------------------------

Beam angle: 12°

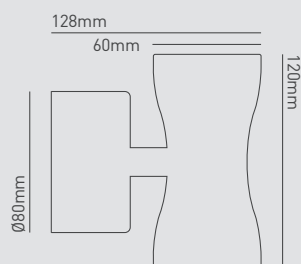
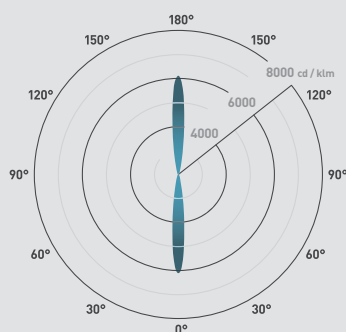

Wall lights.

01604 495 151
collingwoodlighting.com

 @collingwoodLED

 /collingwoodlighting

 collingwoodled

GUARANTEE / WARRANTY

7 year extended warranty

FEATURES & BENEFITS

Bi-directional wall light offering decorative halo effect and functional downward flood light

Straight to mains

Complete with wall fixings and waterproof crimp connectors



WL060

Straight to mains LED halo / flood wall light

FEATURES

Wattage	2.6W
IP rating	IP65
Colour flexibility	Fixed colour
Tiltable	No
Rotatable	No
Dimmable	No
Input	Mains AC
LED lifetime	70,000h L70 B10
SDCM	3SDCM

INSTALLATION INFORMATION

Bathroom zone	2
Inrush current	9A 0.8ms
Construction material	Anodised aluminium
Weight	0.6kg
Maximum ambient temperature	40°C
SELV	Yes
Electric class [1, 2, 3]	1

PHOTOMETRICS @ 25°C

Product code	Finish	Colour	Beam angle	CRI	lm	lm/W	lx at 1m
WL060 NW	Silver	4000K	110°	>80Ra	82	32	46
WL060 WW	Silver	3000K	110°	>80Ra	58	22	26
WL060 27	Silver	2700K	110°	>80Ra	56	22	25

WIRING INFORMATION

Cable / flying lead	0.3m
Type of wiring required	Parallel

LED DRIVERS

Product code	Input	SELV	Dimming	Bathroom zone	Min	Max
N/A (integrated SELV driver)	220-240V	Yes	No	N/A	N/A	N/A

ACCESSORIES

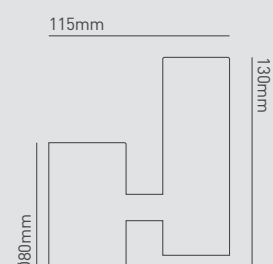
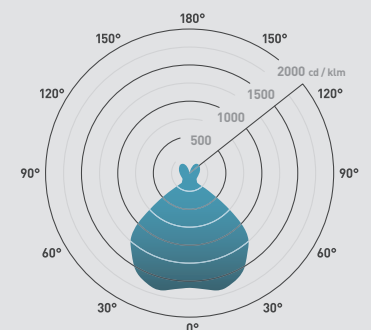

N/A	No accessories required
-----	-------------------------

Beam angle: 110°



Wall lights.

01604 495 151
collingwoodlighting.com

-  @collingwoodLED
-  /collingwoodlighting
-  collingwoodled

GUARANTEE / WARRANTY

7 year extended warranty

FEATURES & BENEFITS

Bi-directional wall light offering decorative halo effect and functional downward flood light

Straight to mains

Complete with wall fixings and waterproof crimp connectors



WL160

Straight to mains LED halo / flood wall light

FEATURES

Wattage	2.6W
IP rating	IP65
Colour flexibility	Fixed colour
Tiltable	No
Rotatable	No
Dimmable	No
Input	Mains AC
LED lifetime	70,000h L70 B10
SDCM	3SDCM

INSTALLATION INFORMATION

Bathroom zone	2
Inrush current	9A 0.8ms
Construction material	Anodised aluminium
Weight	0.6kg
Maximum ambient temperature	40°C
SELV	Yes
Electric class [1, 2, 3]	1

PHOTOMETRICS @ 25°C

Product code	Finish	Colour	Beam angle	CRI	lm	lm/W	lx at 1m
WL160 NW	Black	4000K	110°	>80Ra	82	32	46
WL160 WW	Black	3000K	110°	>80Ra	58	22	26
WL160 27	Black	2700K	110°	>80Ra	56	22	25

WIRING INFORMATION

Cable / flying lead	0.3m
Type of wiring required	Parallel

LED DRIVERS

Product code	Input	SELV	Dimming	Bathroom zone	Min	Max
N/A (integrated SELV driver)	220-240V	Yes	No	N/A	N/A	N/A

ACCESSORIES

N/A	No accessories required
-----	-------------------------

Beam angle: 110°

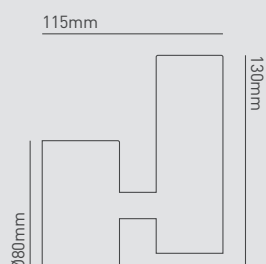
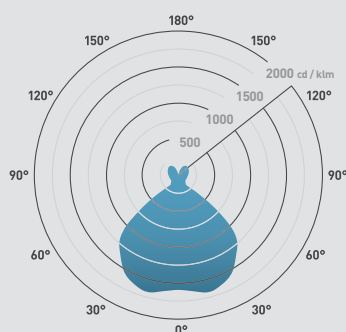

Wall lights.

01604 495 151
collingwoodlighting.com

 @collingwoodLED

 /collingwoodlighting

 collingwoodled

GUARANTEE / WARRANTY

7 year extended warranty

FEATURES & BENEFITS

Improved look and feel with single LED

Straight to mains wall light, perfect for framing entrances and illuminating columns

Quality brushed aluminium finish

Long lifetime of 70,000hrs



WL075

Straight to mains, high output LED wall light

FEATURES

Wattage	5.7W
IP rating	IP65
Colour flexibility	Fixed colour
Tiltable	No
Rotatable	No
Dimmable	No
Input	Mains AC
LED lifetime	70,000h L70 B10
SDCM	3SDCM

INSTALLATION INFORMATION

Bathroom zone	2
Inrush current	60A 0.037ms
Construction material	Anodised aluminium
Weight	1.2kg
Maximum ambient temperature	40°C
SELV	Yes
Electric class (1, 2, 3)	1

PHOTOMETRICS @ 25°C

Product code	Finish	Colour	Beam angle	CRI	lm	lm/W	lx at 1m
WL075BNBM40	Black	4000K	12°	>80Ra	530	93	2843
WL075BNBM30	Black	3000K	12°	>80Ra	520	91	2789
WL075BNBM27	Black	2700K	12°	>80Ra	515	90	2763
WL075ZNBM40	Bronze	4000K	12°	>80Ra	530	93	2843
WL075ZNBM30	Bronze	3000K	12°	>80Ra	520	91	2789
WL075ZNBM27	Bronze	2700K	12°	>80Ra	515	90	2763
WL075SNBM40	Silver	4000K	12°	>80Ra	530	93	2843
WL075SNBM30	Silver	3000K	12°	>80Ra	520	91	2789
WL075SNBM27	Silver	2700K	12°	>80Ra	515	90	2763

WIRING INFORMATION

Cable / flying lead	0.3m
Type of wiring required	Parallel

LED DRIVERS

Product code	Input	SELV	Dimming	Bathroom zone	Min	Max
N/A (integrated SELV driver)	220-240V	Yes	No	N/A	N/A	N/A

ACCESSORIES

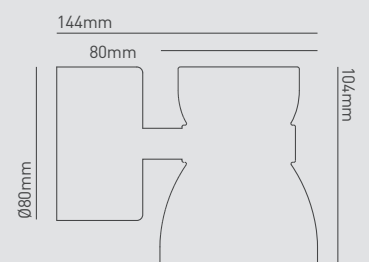
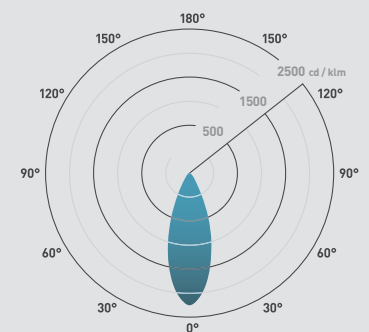

N/A	No accessories required
-----	-------------------------

Beam angle: 12°



Wall lights.

01604 495 151
collingwoodlighting.com

 @collingwoodLED
 /collingwoodlighting
 collingwoodled

GUARANTEE / WARRANTY

7 year extended warranty

FEATURES & BENEFITS

Unique radial appearance creates a decorative lit effect on surrounding surfaces

Can be used for interior and exterior applications

Straight to mains for easy installation

Complete with bracket and waterproof crimp connectors



WL041IP

Straight to mains, fan effect LED wall light

FEATURES

Wattage	1.6W
IP rating	IP65
Colour flexibility	Fixed colour
Tiltable	No
Rotatable	No
Dimmable	No
Input	Mains AC
LED lifetime	70,000h L70 B10
SDCM	3SDCM

INSTALLATION INFORMATION

Bathroom zone	2
Inrush current	9A 0.8ms
Construction material	Anodised aluminium
Weight	0.3kg
Maximum ambient temperature	35°C
SELV	Yes
Electric class [1, 2, 3]	1

PHOTOMETRICS @ 25°C

Product code	Finish	Colour	CRI	lm	lm/W	lx at 1m
WL041 IP NW	Silver	4000K	>80Ra	37	23	8
WL041 IP WW	Silver	3000K	>80Ra	33	21	6
WL041 IP 27	Silver	2700K	>80Ra	32	20	6
WL041 IP AMBER	Silver	Amber	>80Ra	-	-	-
WL041 IP BLUE	Silver	Blue	>80Ra	-	-	-

WIRING INFORMATION

Cable / flying lead	0.3m
Type of wiring required	Parallel

LED DRIVERS

Product code	Input	SELV	Dimming	Bathroom zone	Min	Max
N/A (integrated SELV driver)	220-240V	Yes	No	N/A	N/A	N/A

ACCESSORIES

N/A	No accessories required
-----	-------------------------

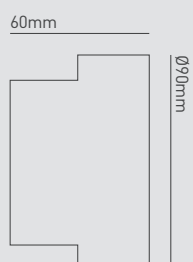
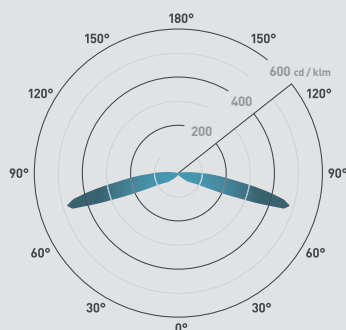

Wall lights.

01604 495 151
collingwoodlighting.com

 @collingwoodLED

 /collingwoodlighting

 collingwoodled

GUARANTEE / WARRANTY

7 year extended warranty

FEATURES & BENEFITS

Straight to mains

High efficacy - up to 93lm/W

Improved look and feel with single LED

New stainless steel and anodised bronze finishes

Higher light output than predecessor



WL220 MAINS

Straight to mains LED wall light

FEATURES

Wattage	5.7W
IP rating	IP65
Colour flexibility	Fixed colour
Tiltable	90°
Rotatable	330°
Dimmable	No
Input	Mains AC
LED lifetime	70,000h L70 B10
SDCM	3SDCM

INSTALLATION INFORMATION

Bathroom zone	2
Inrush current	60A 0.037ms
Construction material	Anodised aluminium Stainless steel 316 Copper
Weight	0.5kg
Maximum ambient temperature	50°C
SELV	Yes
Electric class [1, 2, 3]	1

PHOTOMETRICS @ 25°C

Product code	Finish	Colour	Beam angle	CRI	lm	lm/W	lx at 1m
WL220BWBM40	Black	4000K	40°	>80Ra	530	93	1205
WL220BWBM30	Black	3000K	40°	>80Ra	520	91	1182
WL220BWBM27	Black	2700K	40°	>80Ra	515	90	1171
WL220ZWBM40	Bronze	4000K	40°	>80Ra	530	93	1205
WL220ZWBM30	Bronze	3000K	40°	>80Ra	520	91	1182
WL220ZWBM27	Bronze	2700K	40°	>80Ra	515	90	1171
WL220CWBM27	Copper	2700K	40°	>80Ra	515	90	1171
WL220DWBM40	Silver	4000K	40°	>80Ra	530	93	1205
WL220DWBM30	Silver	3000K	40°	>80Ra	520	91	1182
WL220DWBM27	Silver	2700K	40°	>80Ra	515	90	1171

WIRING INFORMATION

Cable / flying lead	0.3m
Type of wiring required	Parallel

LED DRIVERS

Product code	Input	SELV	Dimming	Bathroom zone	Min	Max
N/A (integrated SELV driver)	220-240V	Yes	No	N/A	N/A	N/A

ACCESSORIES

GH220	Simple hood to reduce glare whilst maintaining a good light distribution	Sold Separately	282
GS220	Simple snoot to reduce glare whilst maintaining a good light distribution	Sold Separately	282

Beam angle: 40°

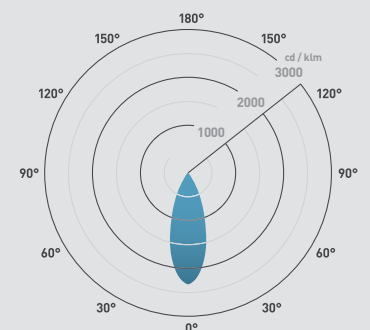

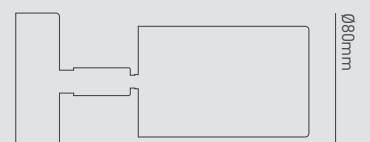

145mm



Wall lights.

01604 495 151
collingwoodlighting.com

-  @collingwoodLED
-  /collingwoodlighting
-  collingwoodled

GUARANTEE / WARRANTY

7 year extended warranty

FEATURES & BENEFITS

- Equivalent to 50W halogen
- Complete with wall fixings and waterproof crimp connectors
- Adjustable angle to direct light
- Cowl design to reduce glare
- Suitable for indoor and outdoor use

Beam angle: 38°

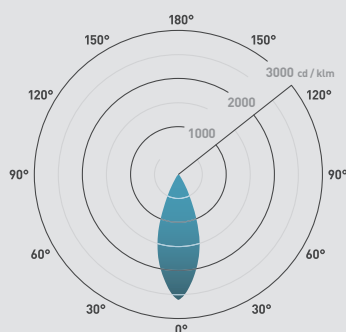

208mm

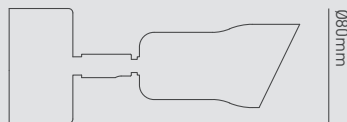

256



WL140A F

Straight to mains LED wall light

FEATURES

Wattage	8W
IP rating	IP65
Colour flexibility	Fixed colour
Tiltable	90°
Rotatable	350°
Dimmable	No
Input	Mains AC
LED lifetime	70,000h L70 B10
SDCM	3SDCM

INSTALLATION INFORMATION

Bathroom zone	2
Inrush current	15A 0.5ms
Construction material	Anodised aluminium
Weight	0.7kg
Maximum ambient temperature	35°C
SELV	Yes
Electric class [1, 2, 3]	1

PHOTOMETRICS @ 25°C

Product code	Finish	Colour	Beam angle	CRI	lm	lm/W	lx at 1m
WL140A F NW	Black	4000K	38°	>80Ra	520	65	1471
WL140A F WW	Black	3000K	38°	>80Ra	413	52	1168
WL140A F 27	Black	2700K	38°	>80Ra	400	50	1135

WIRING INFORMATION

Cable / flying lead	0.3m
Type of wiring required	Parallel

LED DRIVERS

Product code	Input	SELV	Dimming	Bathroom zone	Min	Max
N/A (integrated SELV driver)	220-240V	Yes	No	N/A	N/A	N/A

ACCESSORIES

N/A	No accessories required
-----	-------------------------

Wall lights.

01604 495 151
collingwoodlighting.com

 @collingwoodLED

 /collingwoodlighting

 collingwoodled

GUARANTEE / WARRANTY

7 year extended warranty

FEATURES & BENEFITS

Equivalent to 50W halogen

Complete with wall fixings and waterproof crimp connectors

Adjustable angle to direct light

Cowl design to reduce glare

Suitable for indoor and outdoor use



WL240A F

Straight to mains LED wall light

FEATURES

Wattage	8W
IP rating	IP65
Colour flexibility	Fixed colour
Tilttable	90°
Rotatable	350°
Dimmable	No
Input	Mains AC
LED lifetime	70,000h L70 B10
SDCM	3SDCM

INSTALLATION INFORMATION

Bathroom zone	2
Inrush current	15A 0.5ms
Construction material	Anodised aluminium
Weight	0.7kg
Maximum ambient temperature	35°C
SELV	
Electric class [1, 2, 3]	1

PHOTOMETRICS @ 25°C

Product code	Finish	Colour	Beam angle	CRI	lm	lm/W	lx at 1m
WL240A F NW	Silver	4000K	38°	>80Ra	520	65	1471
WL240A F WW	Silver	3000K	38°	>80Ra	413	52	1168
WL240A F 27	Silver	2700K	38°	>80Ra	400	50	1135

WIRING INFORMATION

Cable / flying lead	0.3m
Type of wiring required	Parallel

LED DRIVERS

Product code	Input	SELV	Dimming	Bathroom zone	Min	Max
N/A (integrated SELV driver)	220-240V	Yes	No	N/A	N/A	N/A

ACCESSORIES

N/A	No accessories required
-----	-------------------------

Beam angle: 38°

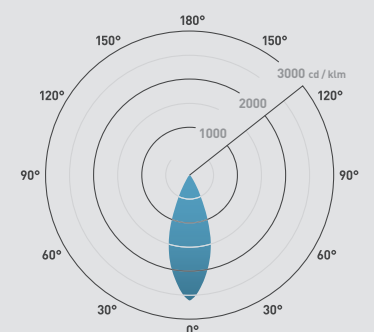

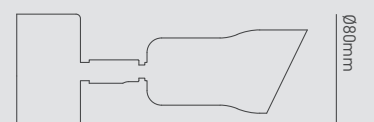

208mm



Wall lights.

01604 495 151
collingwoodlighting.com

-  @collingwoodLED
-  /collingwoodlighting
-  collingwoodled

GUARANTEE / WARRANTY

7 year extended warranty

FEATURES & BENEFITS

Grazes light across the surrounding surface in four directions to create a decorative lit effect

Can be rotated to direct light in desired direction

Complete with wall fixings

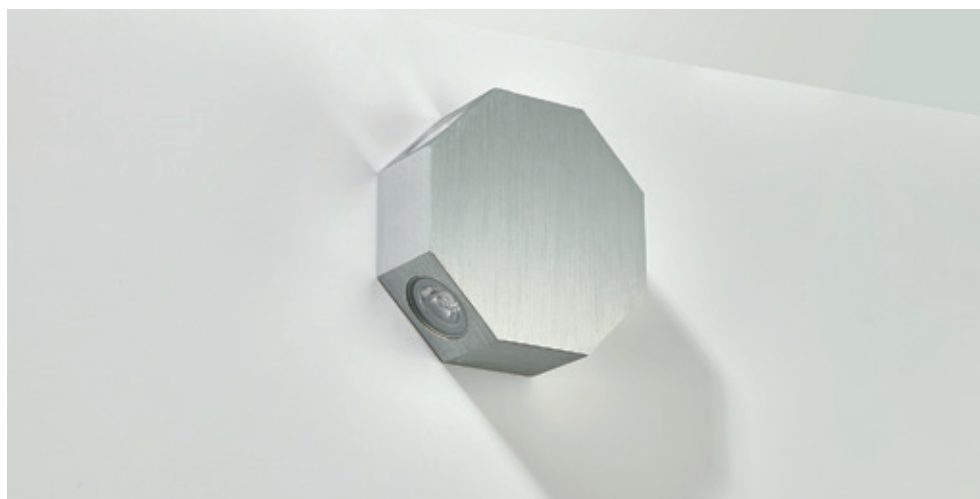

OCTOLED

Rotatable, octagonal LED wall light

FEATURES

Wattage	4W
IP rating	IP65
Colour flexibility	Fixed colour
Tiltable	No
Rotatable	350°
Dimmable	No
Input	350mA
LED lifetime	70,000h L70 B10
SDCM	3SDCM

INSTALLATION INFORMATION

Bathroom zone	1
Inrush current	N/A
Construction material	Anodised aluminium
Weight	0.7kg
Maximum ambient temperature	35°C
SELV	N/A
Electric class [1, 2, 3]	3

PHOTOMETRICS @ 25°C

Product code	Finish	Colour	Beam angle	CRI	lm	lm/W	lx at 1m
OCTOLEDNW	Silver	4000K	12°	>80Ra	280	70	1485
OCTOLEDWW	Silver	3000K	12°	>80Ra	220	55	1466
OCTOLED27	Silver	2700K	12°	>80Ra	214	54	1425

WIRING INFORMATION

Cable / flying lead	0.05m (0.205mm² red & black PTFE)
Type of wiring required	Series

LED DRIVERS

Product code	Input	SELV	Dimming	Bathroom zone	Min	Max
PLU/350 1-9	220-240V	Yes	No	1	1	2
PLR/350 1-5		Yes	No	1	1	2
PLD UNI-DRIVE 350MA		Yes	Yes (1-10V)	2	1	2

ACCESSORIES

PDC/GRID DIMMER	Grid dimmer kit for multiple fitting types	422
-----------------	--	---------------------

Beam angle: 12°

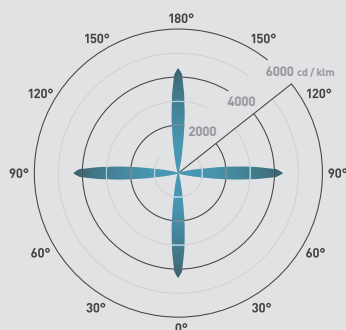



38mm



Wall lights.

01604 495 151
collingwoodlighting.com

-  @collingwoodLED
-  /collingwoodlighting
-  collingwoodled

GUARANTEE / WARRANTY

7 year extended warranty

FEATURES & BENEFITS

Complete with wall fixings and waterproof crimp connectors

Equivalent to 35W halogen



MC040

Straight to mains LED wall light

FEATURES

Wattage	5W
IP rating	IP65
Colour flexibility	Fixed colour
Tilttable	No
Rotatable	No
Dimmable	No
Input	Mains AC
LED lifetime	70,000h L70 B10
SDCM	3SDCM

INSTALLATION INFORMATION

Bathroom zone	2
Inrush current	9A 0.8ms
Construction material	Anodised aluminium
Weight	0.9kg
Maximum ambient temperature	35°C
SELV	Yes
Electric class (1, 2, 3)	1

PHOTOMETRICS @ 25°C

Product code	Finish	Colour	Beam angle	CRI	lm	lm/W	lx at 1m
MC040 NW	Silver	4000K	110°	>80Ra	312	62	163
MC040 WW	Silver	3000K	110°	>80Ra	243	48	118
MC040 27	Silver	2700K	110°	>80Ra	236	47	158

WIRING INFORMATION

Cable / flying lead	0.3m
Type of wiring required	Parallel

LED DRIVERS

Product code	Input	SELV	Dimming	Bathroom zone	Min	Max
N/A (integrated SELV driver)	220-240V	Yes	No	N/A	N/A	N/A

ACCESSORIES

N/A	No accessories required
-----	-------------------------

Beam angle: 110°

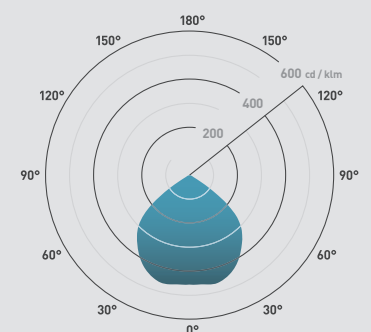

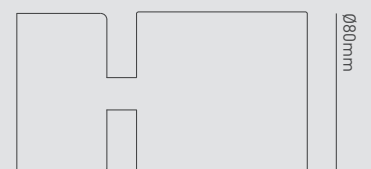

156mm



Wall lights.

01604 495 151
collingwoodlighting.com

-  @collingwoodLED
-  /collingwoodlighting
-  collingwoodled

GUARANTEE / WARRANTY

7 year extended warranty

FEATURES & BENEFITS

Complete with wall fixings and waterproof crimp connectors

Integral LED light for decorative effect (MC050)

Equivalent to 35W halogen

Beam angle: 110°

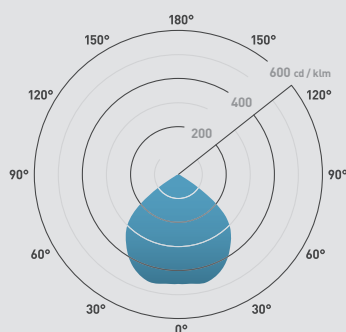

156mm

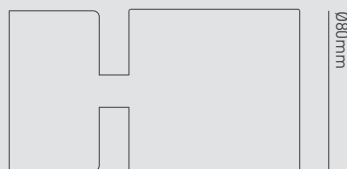

MC050

Straight to mains, decorative wall light

FEATURES

Wattage	6.5W
IP rating	IP65
Colour flexibility	Fixed colour
Tiltable	No
Rotatable	No
Dimmable	No
Input	Mains AC
LED lifetime	70,000h L70 B10
SDCM	3SDCM

INSTALLATION INFORMATION

Bathroom zone	2
Inrush current	9A 0.8ms
Construction material	Anodised aluminium
Weight	0.9kg
Maximum ambient temperature	35°C
SELV	Yes
Electric class [1, 2, 3]	1

PHOTOMETRICS @ 25°C

Product code	Finish	Colour	Beam angle	CRI	lm	lm/W	lx at 1m
MC050 NW	Silver	4000K	110°	>80Ra	312	48	163
MC050 WW	Silver	3000K	110°	>80Ra	243	37	118
MC050 27	Silver	2700K	110°	>80Ra	236	36	158

WIRING INFORMATION

Cable / flying lead	0.3m
Type of wiring required	Parallel

LED DRIVERS

Product code	Input	SELV	Dimming	Bathroom zone	Min	Max
N/A (integrated SELV driver)	220-240V	Yes	No	N/A	N/A	N/A

ACCESSORIES

N/A	No accessories required
-----	-------------------------



Pond lights.

A flexible solution

Whether illuminating the edges of ponds or completely submerging in water, the durability of Collingwood products will suit every requirement.

Flexibility

With a 360° rotation and 180° tilt, our pond lights provide ultimate flexibility with the ability to be pointed in any direction, illuminating the areas you want to showcase.

360° rotation

This is achieved with an adjustable bracket at the base of the product.



180° tiltable

Using the bracket directly attached to the product, the light can be tilted up and downwards.



Marine grade steel

Using stainless steel 316, our products are completely protected from the effects of rust and salt water corrosion.

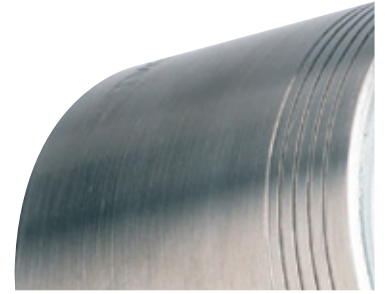

Mount anywhere

Designed with flexibility in mind, our fittings can be mounted on to most surfaces. The screw-in structure allows for attaching to a hard surface securely, where recessing a light is impossible.

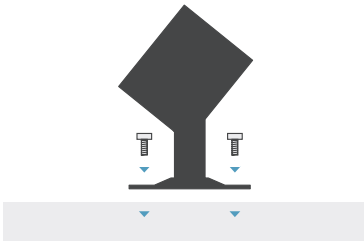

Output options

Both products have a narrow beam which means punchy illumination from a neat and compact fitting. As each installation is unique, it may require a high or low output fitting.

High output

The UL030 is ideal for general illumination.



Low output

The UL010 works well for subtle feature illumination.



Discreet fittings

We understand the focus of lighting should be the illumination, not the fitting, which is why the flexible nature of these products ensure they are easy to conceal in a landscape.



Pond lights.

Underwater lighting

Illuminating a pond or water feature will help transform any landscape design, creating a focal point whilst also adding a layer of protection, ensuring passers-by are aware of where water is located.

Lighting effect

A number of effects can be created when strategically lighting water and water features.

Backlighting waterfalls

Adding lighting to the soothing sound of a waterfall can create a calm and peaceful atmosphere.



Reflections

Aesthetically pleasing to the eye, uplight shrubs and trees to allow unique reflections to be cast into the water.



Highlighting water features

Maintain maximum visual impact after the sun sets by using spot lighting to highlight water features.



Adding depth to your landscape

Highlighting water features can add significant depth and appeal to the overall landscape design.



Submersible fittings

Our Collingwood patented technology ensures that our IP68 rated pond lights are completely air tight and can be used underwater. Using stainless steel 316, our products are completely protected from the effects of rust and salt water corrosion.



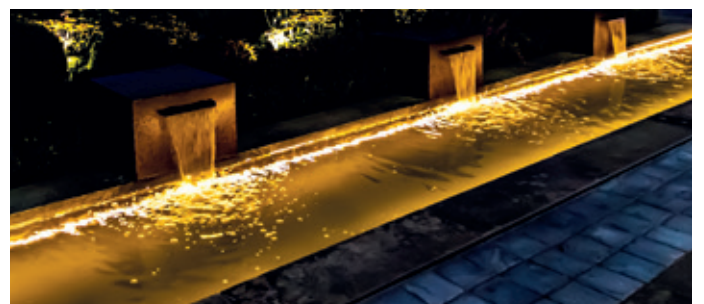

The ripple effects

As water moves and ripples, the light moves with it. This adds a sense of motion and fluidity to your scheme and sparks visual interest.



Pond lights.

01604 495 151
collingwoodlighting.com

-  @collingwoodLED
-  /collingwoodlighting
-  collingwoodled

GUARANTEE / WARRANTY

7 year extended warranty

FEATURES & BENEFITS

- Improved look and feel with single LED
- Complete with wall fixings
- Tilt & rotate for adjusting light
- Marine grade stainless steel 316
- Long lifetime of 70,000hrs



UL030

High output universal LED light

FEATURES

Wattage	7W
IP rating	IP68
Colour flexibility	Fixed colour
Tilttable	360°
Rotatable	360°
Dimmable	N/A
Input	Driver required
LED lifetime	70,000h L70 B10
SDCM	3SDCM

INSTALLATION INFORMATION

Bathroom zone	0
Construction material	Stainless steel (316)
Weight	645g
Maximum ambient temperature	50°C
SELV	N/A
Electric class (1, 2, 3)	3

PHOTOMETRICS @ 25°C

Product code	Colour	Beam angle	CRI	lm	lm/W	lx at 1m
UL030DWBX40	4000K	40°	>80Ra	490	109	1050
UL030DNBX40	4000K	12°	>80Ra	490	109	7975
UL030DWBX30	3000K	40°	>80Ra	480	107	1029
UL030DNBX30	3000K	12°	>80Ra	480	107	7812
UL030DWBX27	2700K	40°	>80Ra	470	104	1007
UL030DNBX27	2700K	12°	>80Ra	470	104	7649

WIRING INFORMATION

Cable / flying lead	1m (H05RN-F) rubberised cable (outside diameter: 6mm)
Type of wiring required	Series

LED DRIVERS

Product code	Input	SELV	Dimming	Bathroom zone	Min	Max
PLU/700 3-9	220-240V	Yes	No	1	1	1
PLD UNI-DRIVE 700mA	220-240V	Yes	Yes (1-10V)	2	1	6

ACCESSORIES

JB2 / JB4	Waterproof junction box / Gel filled waterproof connector	Sold separately	422-423
PDC/GRID DIMMER	Grid dimmer kit for multiple fitting types	Sold separately	422
WCR 275 BLACK	2-core rubber cable	Sold separately	423

Beam angle: 12° 40°

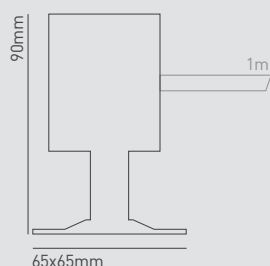
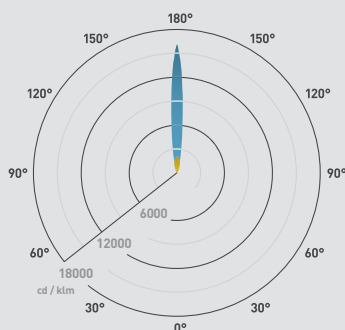

Pond lights.

01604 495 151
collingwoodlighting.com

 @collingwoodLED

 /collingwoodlighting

 collingwoodled

GUARANTEE / WARRANTY

7 year extended warranty

FEATURES & BENEFITS

Complete with wall fixings
Robust cable for use outdoors
Tilt & rotate for adjusting light



UL010

Universal LED light

FEATURES

Wattage	3W
IP rating	IP68
Colour flexibility	Fixed colour
Tilttable	360°
Rotatable	360°
Dimmable	N/A
Input	700mA
LED lifetime	70,000h L70 B10
SDCM	3SDCM

INSTALLATION INFORMATION

Bathroom zone	0
Construction material	Stainless steel (316)
Weight	567g
Maximum ambient temperature	35°C
SELV	N/A
Electric class [1, 2, 3]	3

PHOTOMETRICS @ 25°C

Product code	Colour	Beam angle	CRI	lm	lm/W	lx at 1m
UL010 NW	4000K	18°	>80Ra	119	40	648
UL010 WW	3000K	18°	>80Ra	95	32	411
UL010 27	2700K	18°	>80Ra	92	31	399
UL010 BL	Blue	18°	-	-	-	-

WIRING INFORMATION

Cable / flying lead	3m (H05RN-F) rubberised cable (outside diameter: 6mm)
Type of wiring required	Series

LED DRIVERS

Product code	Input	SELV	Dimming	Bathroom zone	Min	Max
PLU/700 3-9	220-240V	Yes	No	1	3	9
PLD UNI-DRIVE 700mA	220-240V	Yes	Yes (1-10V)	2	1	10

ACCESSORIES

JB2 / JB4	Waterproof junction box / Gel filled waterproof connector	Sold separately	422-423
PDC/GRID DIMMER	Grid dimmer kit for multiple fitting types	Sold separately	422
WCR 275 BLACK	2-core rubber cable	Sold separately	423

Beam angle: 18°

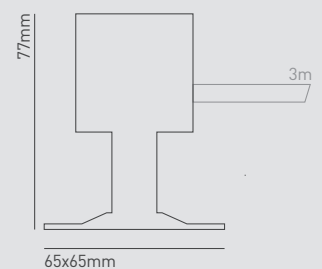
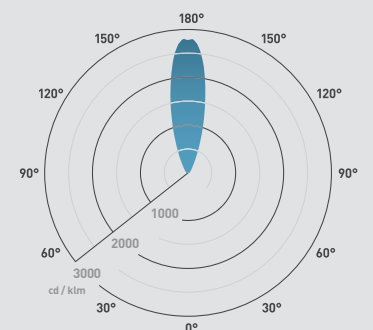

Uplights.

To create exceptionally lit environments

In architecture, the façade of a building is the first place a visitor will see, and sets the tone for the rest of the building. Captivate passers-by with a mesmerising wash of light over any beautiful structure.

Choosing the right beam angle

Our uplighting range is ideal for creating an array of effects; whether you are adding grandeur to buildings, highlighting intricate architectural features or drawing guests to an entrance, we have a solution for many applications.

110° beam

This wide beam is perfect for creating a wash of light on flat surfaces or to illuminate surfaces from further away.



45° beam

Some architectural features require mid-level lighting and the 45° beam is perfect for this, allowing a swathe of light to be cast across a dedicated area.



25x6° beam

Choose the asymmetric 25x6° beam for a more directed beam of light, perfect for walls and entrances.



Choosing the ideal size and output

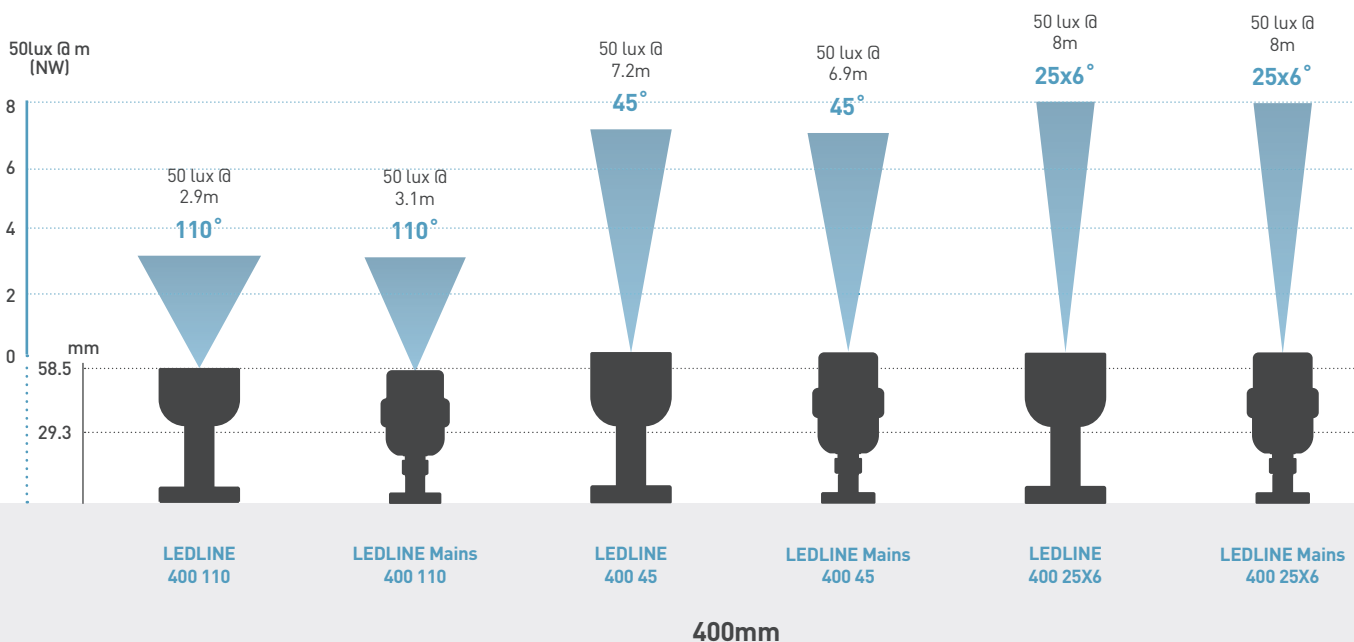

400 vs. 200

Choosing between a 400mm and 200mm LED light bar is very much determined by the application. Opt for a 400mm bar to illuminate larger surfaces such as walls and ledges and 200mm in narrower spaces and more complex structures. Both lengths are available in three beam angle options and three colour temperatures, offering a wide variety of suitable options for your install.

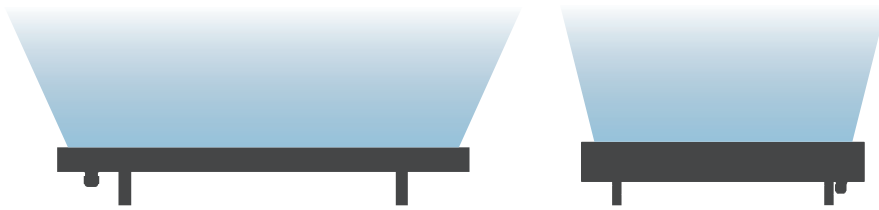

Mains vs. 700mA

Using existing mains cables, the built-in mains driver ensures installation is quicker and easier than ever. With an IP65 rating, robust cable and seven year extended warranty, you can rest assured that our LEDLINE range has the capability to stand the test of time.

UL bracket

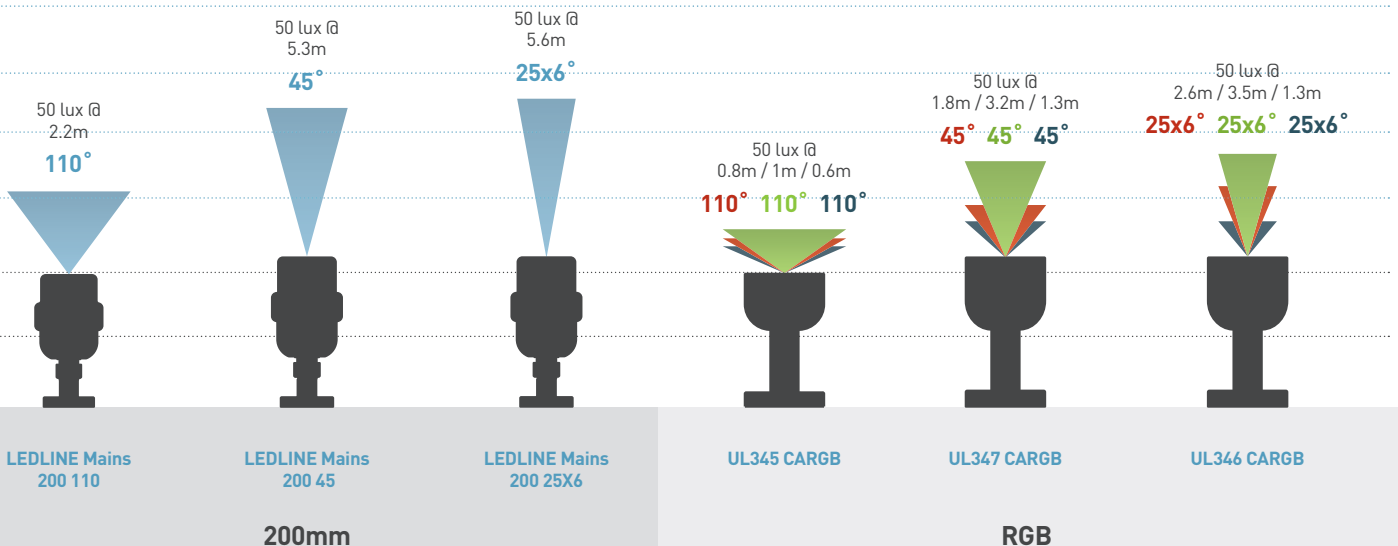

The UL bracket offers the ability to adjust the LEDLINE fitting to an angle of your choice; providing more options for how and where you direct the light.

The bracket is perfect for directing the light back onto a façade, highlighting particular signage or features. The UL bracket must be ordered separately using the partcode: ULBRACKET



Uplights.

01604 495 151
collingwoodlighting.com

-  @collingwoodLED
-  /collingwoodlighting
-  collingwoodled

GUARANTEE / WARRANTY

7 year extended warranty

FEATURES & BENEFITS

Robust cable for permanent use outdoors
Wide beam angle ideal for wall wash

Beam angle: 110°

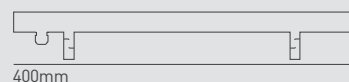
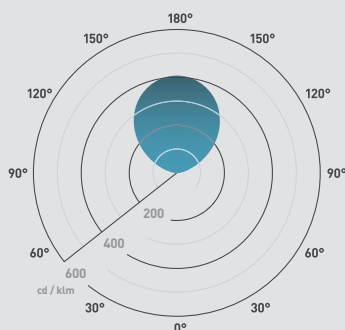

LEDLINE 400 110

110° wall washing light bar

FEATURES

Wattage	16W
IP rating	IP65
IK rating	IK02
Colour flexibility	Fixed colour
Tilttable	180°
Input	Driver Required
LED lifetime	70,000h L70 B10
SDCM	3SDCM

INSTALLATION INFORMATION

Bathroom zone	1
Inrush current	N/A
Construction material	Anodised aluminium
Weight	0.8kg
Maximum ambient temperature	40°C
SELV	N/A
Electric class (1, 2, 3)	3

PHOTOMETRICS @ 25°C

Product code	Colour	Beam angle	CRI	lm	lm/W	lx at 1m
LEDLINE 400 NW 110	4000K	110°	>70Ra	1000	63	422
LEDLINE 400 WW 110	3000K	110°	>80Ra	750	47	316
LEDLINE 400 27 110	2700K	110°	>80Ra	730	46	308

WIRING INFORMATION

Cable / flying lead	3m (H05RN-F) rubberised cable (outside diameter: 6mm)
Type of wiring required	Series

LED DRIVERS

Product code	Input	SELV	Dimming	Bathroom zone	Min	Max
PLU/700 3-9	220-240V	Yes	No	1	1	1
PL/IP/700 3-9	220-240V	Yes	No	1	1	1
PLD UNI-DRIVE 700MA	220-240V	Yes	Yes (1-10V)	2	1	1

ACCESSORIES

JB4 / JB6	Gel filled junction box	Sold separately	423
PDC/GRID DIMMER	Grid dimmer kit for multiple fitting types	Sold separately	422
WCR 275 BLACK	2-core rubber cable	Sold separately	423
ULBRACKET	2-piece black anodised aluminium bracket	Sold separately	277

Uplights.

01604 495 151
collingwoodlighting.com

 @collingwoodLED

 /collingwoodlighting

 collingwoodled

GUARANTEE / WARRANTY

7 year extended warranty

FEATURES & BENEFITS

Wide beam angle ideal for wall wash

Mains driver built-in for quick installation

Robust cable for permanent use outdoors



LEDLINE MAINS 400 110°

110° straight to mains wall washing light bar

FEATURES

Wattage	19W
IP rating	IP65
IK rating	IK02
Colour flexibility	Fixed colour
Tilttable	180°
Input	Mains AC
LED lifetime	70,000h L70 B50
SDCM	3SDCM

INSTALLATION INFORMATION

Bathroom zone	2
Inrush current	2.1A 0.1ms
Construction material	Anodised aluminium
Weight	1.3kg
Maximum ambient temperature	35°C
SELV	Yes
Electric class [1, 2, 3]	1

PHOTOMETRICS @ 25°C

Product code	Colour	Beam angle	CRI	lm	lm/W	lx at 1 m
ULM345M40	4000K	110°	>80Ra	1210	64	493
ULM345M30	3000K	110°	>80Ra	1320	70	537
ULM345M27	2700K	110°	>80Ra	1200	63	489

WIRING INFORMATION

Cable / flying lead	3m (H05RN-F) rubberised cable (outside diameter: 7mm)
Type of wiring required	Parallel

LED DRIVERS

Product code	Input	SELV	Dimming	Bathroom zone	Min	Max
N/A (integrated SELV driver)	220-240V	Yes	No	2	-	-

ACCESSORIES

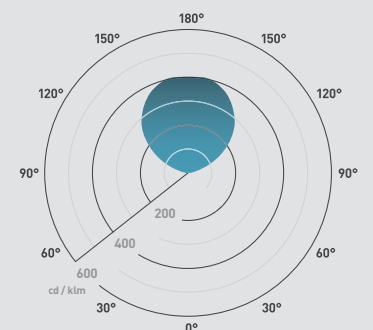

ULBRACKET	2-piece black anodised aluminium bracket	Sold separately	277
-----------	--	-----------------	---------------------

Beam angle: 110°



Uplights.

01604 495 151
collingwoodlighting.com

-  @collingwoodLED
-  /collingwoodlighting
-  collingwoodled

GUARANTEE / WARRANTY

7 year extended warranty

FEATURES & BENEFITS

- Wide beam angle ideal for wall wash
- Mains driver built-in for quick installation
- Robust cable for permanent use outdoors

Beam angle: 110°

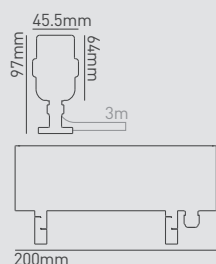
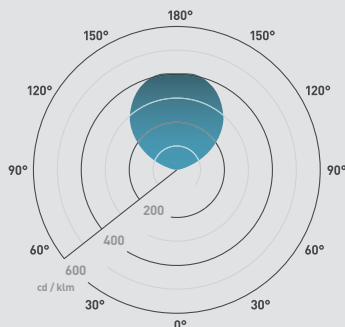

270

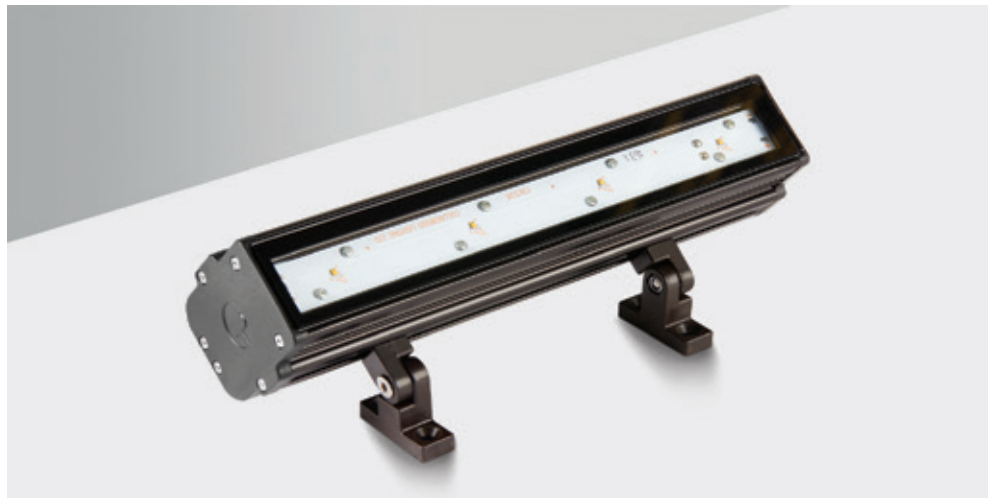

LEDLINE MAINS 200 110°

110° straight to mains wall washing light bar

FEATURES

Wattage	10W
IP rating	IP65
IK rating	IK02
Colour flexibility	Fixed colour
Tilttable	180°
Input	Mains AC
LED lifetime	70,000h L70 B50
SDCM	3SDCM

INSTALLATION INFORMATION

Bathroom zone	2
Inrush current	2.1A 0.1ms
Construction material	Anodised aluminium
Weight	0.8kg
Maximum ambient temperature	35°C
SELV	Yes
Electric class (1, 2, 3)	1

PHOTOMETRICS @ 25°C

Product code	Colour	Beam angle	CRI	lm	lm/W	lx at 1m
ULS345M40	4000K	110°	>80Ra	590	59	253
ULS345M30	3000K	110°	>80Ra	600	60	258
ULS345M27	2700K	110°	>80Ra	580	58	249

WIRING INFORMATION

Cable / flying lead	3m (H05RN-F) rubberised cable (outside diameter: 7mm)
Type of wiring required	Parallel

LED DRIVERS

Product code	Input	SELV	Dimming	Bathroom zone	Min	Max
N/A (integrated SELV driver)	220-240V	Yes	No	2	-	-

ACCESSORIES

ULBRACKET	2-piece black anodised aluminium bracket	Sold separately	277
-----------	--	-----------------	---------------------

Uplights.

01604 495 151
collingwoodlighting.com

 @collingwoodLED

 /collingwoodlighting

 collingwoodled

GUARANTEE / WARRANTY

7 year extended warranty

FEATURES & BENEFITS

Asymmetric beam angle for distance wall wash

Robust cable for permanent use outdoors



LEDLINE 400 25x6

25x6° wall washing light bar

FEATURES

Wattage	16W
IP rating	IP65
IK rating	IK02
Colour flexibility	Fixed colour
Tilttable	180°
Input	Driver Required
LED lifetime	70,000h L70 B10
SDCM	3SDCM

INSTALLATION INFORMATION

Bathroom zone	1
Inrush current	N/A
Construction material	Anodised aluminium
Weight	0.9kg
Maximum ambient temperature	40°C
SELV	N/A
Electric class [1, 2, 3]	3

PHOTOMETRICS @ 25°C

Product code	Colour	Beam angle	CRI	lm	lm/W	lx at 1 m
LEDLINE 400 NW 25X6	4000K	25x6°	>70Ra	1000	63	3174
LEDLINE 400 WW 25X6	3000K	25x6°	>80Ra	750	47	2380
LEDLINE 400 27 25X6	2700K	25x6°	>80Ra	730	46	2317

WIRING INFORMATION

Cable / flying lead	3m (H05RN-F) rubberised cable (outside diameter: 6mm)
Type of wiring required	Series

LED DRIVERS

Product code	Input	SELV	Dimming	Bathroom zone	Min	Max
PLU/700 3-9	220-240V	Yes	No	1	1	1
PL/IP/700 3-9	220-240V	Yes	No	1	1	1
PLD UNI-DRIVE 700MA	220-240V	Yes	Yes (1-10V)	2	1	1

ACCESSORIES

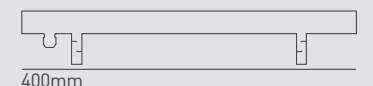
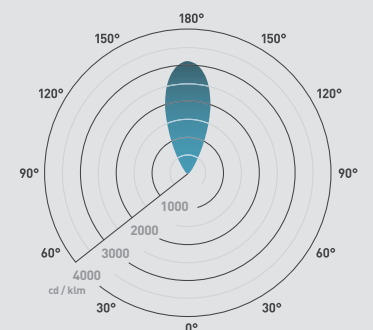

JB4 / JB6	Gel filled junction box	Sold separately	423
PDC/GRID DIMMER	Grid dimmer kit for multiple fitting types	Sold separately	422
WCR 275 BLACK	2-core rubber cable	Sold separately	423
ULBRACKET	2-piece black anodised aluminium bracket	Sold separately	277

Beam angle: 25x6°



Uplights.

01604 495 151
collingwoodlighting.com

-  @collingwoodLED
-  /collingwoodlighting
-  collingwoodled

GUARANTEE / WARRANTY

7 year extended warranty

FEATURES & BENEFITS

- Asymmetric beam angle for distance wall wash
- Mains driver built-in for quick installation
- Robust cable for permanent use outdoors

Beam angle: **C0/C180** **C90/C270**

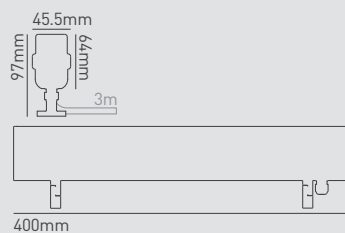
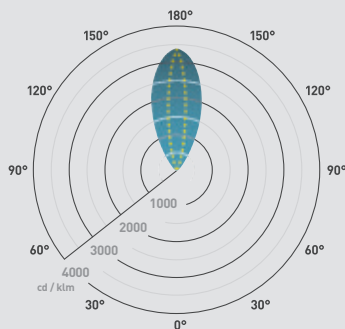

LEDLINE MAINS 400 25x6°

25x6° straight to mains wall washing light bar

FEATURES

Wattage	19W
IP rating	IP65
IK rating	IK02
Colour flexibility	Fixed colour
Tilttable	180°
Input	Mains AC
LED lifetime	70,000h L70 B50
SDCM	3SDCM

INSTALLATION INFORMATION

Bathroom zone	2
Inrush current	2.1A 0.1ms
Construction material	Anodised aluminium
Weight	1.4kg
Maximum ambient temperature	35°C
SELV	Yes
Electric class (1, 2, 3)	1

PHOTOMETRICS @ 25°C

Product code	Colour	Beam angle	CRI	lm	lm/W	lx at 1m
ULM346M40	4000K	25x6°	>80Ra	940	50	3191
ULM346M30	3000K	25x6°	>80Ra	880	46	2987
ULM346M27	2700K	25x6°	>80Ra	860	45	2919

WIRING INFORMATION

Cable / flying lead	3m (H05RN-F) rubberised cable (outside diameter: 7mm)
Type of wiring required	Parallel

LED DRIVERS



Product code	Input	SELV	Dimming	Bathroom zone	Min	Max
N/A (integrated SELV driver)	220-240V	Yes	No	2	-	-

ACCESSORIES

ULBRACKET	2-piece black anodised aluminium bracket	Sold separately	277
-----------	--	-----------------	---------------------

Uplights.

01604 495 151
collingwoodlighting.com

-  @collingwoodLED
-  /collingwoodlighting
-  collingwoodled

GUARANTEE / WARRANTY

7 year extended warranty

FEATURES & BENEFITS

- Asymmetric beam angle for distance wall wash
- Mains driver built-in for quick installation
- Robust cable for permanent use outdoors



LEDLINE MAINS 200 25x6°

25x6° straight to mains wall washing light bar

FEATURES

Wattage	10W
IP rating	IP65
IK rating	IK02
Colour flexibility	Fixed colour
Tilttable	180°
Input	Mains AC
LED lifetime	70,000h L70 B50
SDCM	3SDCM

INSTALLATION INFORMATION

Bathroom zone	2
Inrush current	2.1A 0.1ms
Construction material	Anodised aluminium
Weight	0.9kg
Maximum ambient temperature	35°C
SELV	Yes
Electric class [1, 2, 3]	1

PHOTOMETRICS @ 25°C

Product code	Colour	Beam angle	CRI	lm	lm/W	lx at 1 m
ULS346M40	4000K	25x6°	>80Ra	490	49	1592
ULS346M30	3000K	25x6°	>80Ra	460	46	1494
ULS346M27	2700K	25x6°	>80Ra	450	45	1462

WIRING INFORMATION

Cable / flying lead	3m (H05RN-F) rubberised cable (outside diameter: 7mm)
Type of wiring required	Parallel

LED DRIVERS

Product code	Input	SELV	Dimming	Bathroom zone	Min	Max
N/A (integrated SELV driver)	220-240V	Yes	No	2	-	-

ACCESSORIES

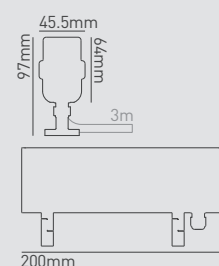
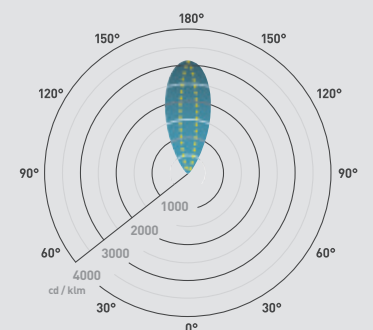

ULBRACKET	2-piece black anodised aluminium bracket	Sold separately	277
-----------	--	-----------------	---------------------

Beam angle: C0/C180 C90/C270



Uplights.

01604 495 151
collingwoodlighting.com

-  @collingwoodLED
-  /collingwoodlighting
-  collingwoodled

GUARANTEE / WARRANTY

7 year extended warranty

FEATURES & BENEFITS

45° beam angle ideal for mid-level wall wash
Robust cable for permanent use outdoors

Beam angle: 45°

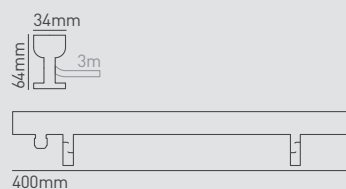
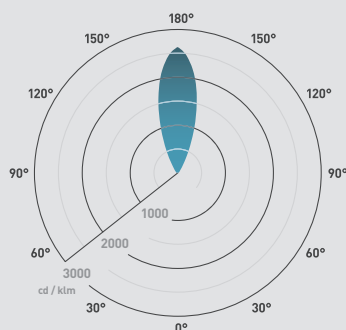

LEDLINE 400 45

45° wall washing light bar

FEATURES

Wattage	16W
IP rating	IP65
IK rating	IK02
Colour flexibility	Fixed colour
Tilttable	180°
Input	Driver Required
LED lifetime	70,000h L70 B10
SDCM	3SDCM

INSTALLATION INFORMATION

Bathroom zone	1
Inrush current	N/A
Construction material	Anodised aluminium
Weight	0.9kg
Maximum ambient temperature	40°C
SELV	N/A
Electric class (1, 2, 3)	3

PHOTOMETRICS @ 25°C

Product code	Colour	Beam angle	CRI	lm	lm/W	lx at 1m
LEDLINE 400 NW 45	4000K	45°	>70Ra	1000	63	2629
LEDLINE 400 WW 45	3000K	45°	>80Ra	750	47	1972
LEDLINE 400 27 45	2700K	45°	>80Ra	730	46	1919

WIRING INFORMATION

Cable / flying lead	3m (H05RN-F) rubberised cable (outside diameter: 6mm)
Type of wiring required	Series

LED DRIVERS

Product code	Input	SELV	Dimming	Bathroom zone	Min	Max
PLU/700 3-9	220-240V	Yes	No	1	1	1
PL/IP/700 3-9	220-240V	Yes	No	1	1	1
PLD UNI-DRIVE 700MA	220-240V	Yes	Yes (1-10V)	2	1	1

ACCESSORIES

JB4 / JB6	Gel filled junction box	Sold separately	423
PDC/GRID DIMMER	Grid dimmer kit for multiple fitting types	Sold separately	422
WCR 275 BLACK	2-core rubber cable	Sold separately	423
ULBRACKET	2-piece black anodised aluminium bracket	Sold separately	277



LEDLINE MAINS 400 45°

45° straight to mains wall washing light bar

FEATURES

Wattage	19W
IP rating	IP65
IK rating	IK02
Colour flexibility	Fixed colour
Tilttable	180°
Input	Mains AC
LED lifetime	70,000h L70 B50
SDCM	3SDCM

INSTALLATION INFORMATION

Bathroom zone	2
Inrush current	2.1A 0.1ms
Construction material	Anodised aluminium
Weight	1.4kg
Maximum ambient temperature	35°C
SELV	Yes
Electric class [1, 2, 3]	1

PHOTOMETRICS @ 25°C

Product code	Colour	Beam angle	CRI	lm	lm/W	lx at 1 m
ULM347M40	4000K	45°	>80Ra	1020	54	2366
ULM347M30	3000K	45°	>80Ra	1000	53	2320
ULM347M27	2700K	45°	>80Ra	970	51	2250

WIRING INFORMATION

Cable / flying lead	3m (H05RN-F) rubberised cable (outside diameter: 7mm)
Type of wiring required	Parallel

LED DRIVERS

Product code	Input	SELV	Dimming	Bathroom zone	Min	Max
N/A (integrated SELV driver)	220-240V	Yes	No	2	-	-

ACCESSORIES

ULBRACKET	2-piece black anodised aluminium bracket	Sold separately	277
-----------	--	-----------------	---------------------

Uplights.

01604 495 151
collingwoodlighting.com

- @collingwoodLED
- /collingwoodlighting
- collingwoodled

GUARANTEE / WARRANTY

7 year extended warranty

FEATURES & BENEFITS

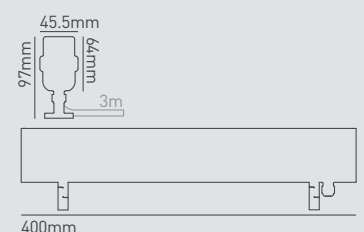
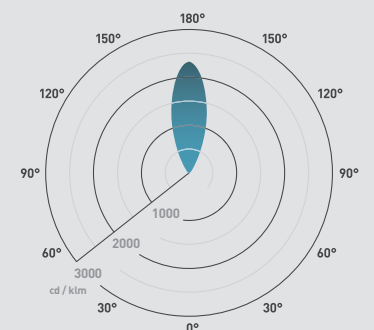

- 45° beam angle ideal for mid-level wall wash
- Mains driver built-in for quick installation
- Robust cable for permanent use outdoors

Beam angle: 45°



Uplights.

01604 495 151
collingwoodlighting.com

-  @collingwoodLED
-  /collingwoodlighting
-  collingwoodled

GUARANTEE / WARRANTY

7 year extended warranty

FEATURES & BENEFITS

- 45° beam angle ideal for mid-level wall wash
- Mains driver built-in for quick installation
- Robust cable for permanent use outdoors

Beam angle: 45°

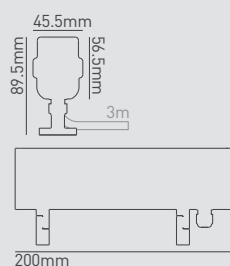
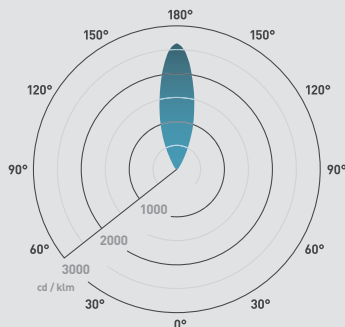

LEDLINE MAINS 200 45°

45° straight to mains wall washing light bar

FEATURES

Wattage	10W
IP rating	IP65
IK rating	IK02
Colour flexibility	Fixed colour
Tilttable	180°
Input	Mains AC
LED lifetime	70,000h L70 B50
SDCM	3SDCM

INSTALLATION INFORMATION

Bathroom zone	2
Inrush current	2.1A 0.1ms
Construction material	Anodised aluminium
Weight	0.9kg
Maximum ambient temperature	35°C
SELV	Yes
Electric class (1, 2, 3)	1

PHOTOMETRICS @ 25°C

Product code	Colour	Beam angle	CRI	lm	lm/W	lx at 1m
ULS347M40	4000K	45°	>80Ra	530	53	1401
ULS347M30	3000K	45°	>80Ra	470	47	1242
ULS347M27	2700K	45°	>80Ra	460	46	1216

WIRING INFORMATION

Cable / flying lead	3m (H05RN-F) rubberised cable (outside diameter: 7mm)
Type of wiring required	Parallel

LED DRIVERS

Product code	Input	SELV	Dimming	Bathroom zone	Min	Max
N/A (integrated SELV driver)	220-240V	Yes	No	2	-	-

ACCESSORIES

ULBRACKET	2-piece black anodised aluminium bracket	Sold separately	277
-----------	--	-----------------	---------------------

Uplights.

01604 495 151
collingwoodlighting.com

 @collingwoodLED

 /collingwoodlighting

 collingwoodled

GUARANTEE / WARRANTY

1 year guarantee

FEATURES & BENEFITS

Supplied with fixtures & fittings



ULBRACKET

2-piece black anodised aluminium bracket

INSTALLATION INFORMATION

Construction material	Aluminium
Weight	150g

PRODUCT CODES

Product codes	Description
ULBRACKET	2-piece black anodised aluminium bracket

USE WITH

LEDLINE 400 110	110° LED wall washing light bar
LEDLINE 400 25X6	25X6° LED wall washing light bar
LEDLINE 400 45	45° LED wall washing light bar
LEDLINE MAINS 400 110	110° straight to mains LED wall washing light bar
LEDLINE MAINS 400 25x6	25X6° straight to mains LED wall washing light bar
LEDLINE MAINS 400 45	45° straight to mains LED wall washing light bar
LEDLINE MAINS 200 110	110° straight to mains LED wall washing light bar
LEDLINE MAINS 200 25x6	25X6° straight to mains LED wall washing light bar
LEDLINE MAINS 200 45	45° straight to mains LED wall washing light bar
UL345CARGB	110° colour change LED wall washing light bar
UL346CARGB	25x6° colour change LED wall washing light bar
UL347CARGB	45° colour change LED wall washing light bar

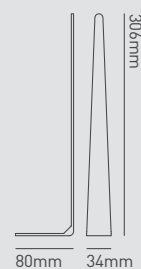

Spike lights.

To create engaging outdoor spaces

Whether lighting a pathway, planting or to really embellish an outdoor feature, spike lights are a great addition to any environment.

Choose your effect

Spike lights can be used in a variety of ways, for example, illuminating pathways, highlighting mid-level planting or to pick out certain features within a garden. The great thing about these products is that they can move as your landscape changes season to season, year to year.



Pathways



Mid-level planting



Features

Layering light

Spike lights can effectively work as the main focus of an outdoor lighting scheme; however, they also work well in spreading the focus throughout an installation. Combine various effects using these versatile fittings to light features at different levels and to create a scene with depth and interest. Pathway lighting can be combined with uplighting to create a multi-layered effect.



Light confined to one area



Light spread across installation

Product comparison

Use the diagram to work out which size product and output is ideal for your installation.

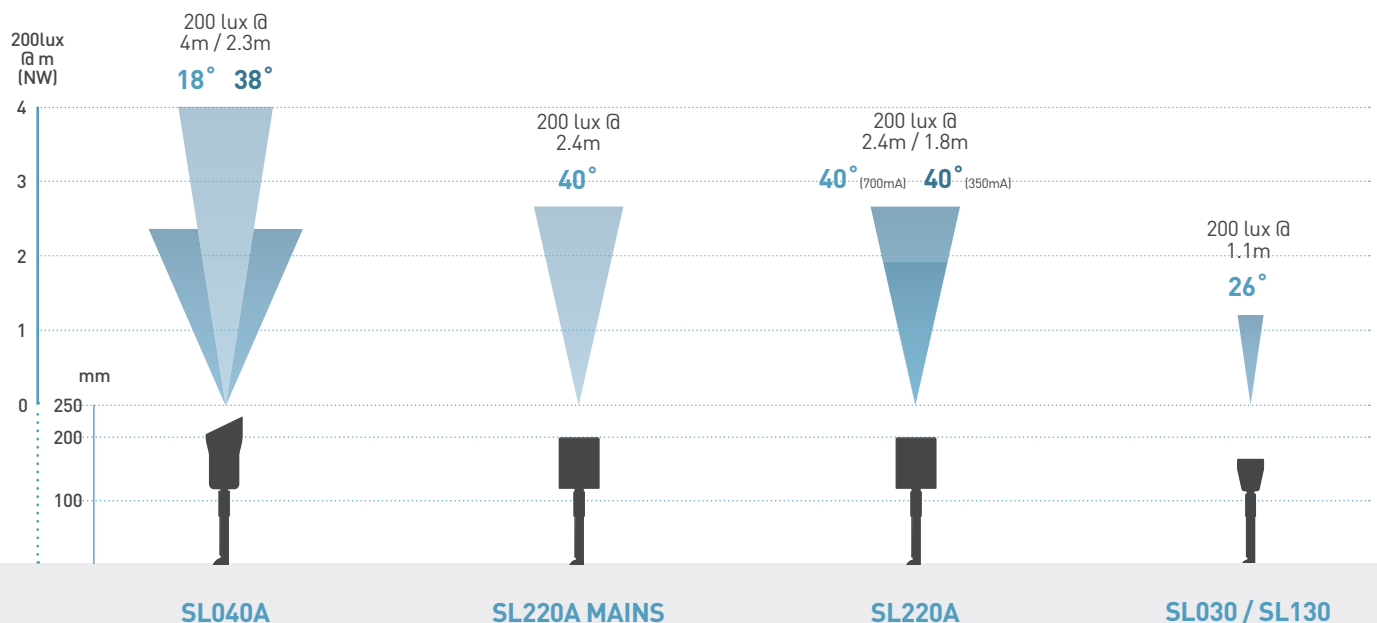

All spike lights continue 240mm under the surface.

Low voltage vs. mains

Choose the right connection for any install with both mains and low voltage options available. These are ideal for both retro-fit and new installations.

All of our spike lights come with 3m integrated cable as standard for ease of installation.

Waterproof

Our spike lights are waterproof to IP65 and have been designed for permanent use outdoors. Spike lights must be installed using waterproof connections to avoid moisture ingress through non-waterproof joints. To choose from our range waterproof connectors, please see page 422-423.



Check out our IP rated installation video on the Collingwood Lighting YouTube channel.

Low glare hoods and snoots

Upgrade the look and feel of your spike light installation with a simple low glare hood or snoot accessory. The accessories minimise any 'spill light' from the product to create a crisp beam of light which is low glare.

Standard spike light

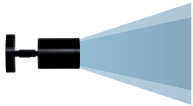

Flexible spike lighting with a high-quality fixture. Without using an accessory the beam of light has a soft halo around the measured beam angle.

Low glare hood



A simple solution to create discreet lighting whilst optimising the light distribution. The widest part of the hood reduces the spill light from one side of the light.

Low glare snoot



This cylindrical snoot accentuates the style factor. Perfect for creating a moonlight effect the snoot reduces the spill light in all directions.

Discreet lighting

Conceal your spike lights to allow attention to focus on the illumination, not the light source.

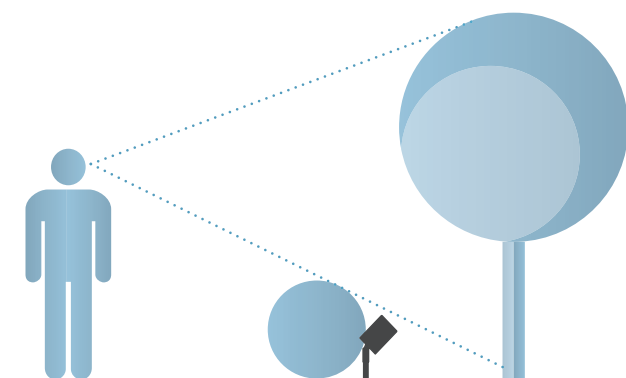

Flexibility

Spike lights are the most flexible lighting choice for a garden as they can be used in a variety of environments and are easy to manoeuvre, allowing the option to change the lighting scheme to reflect the season.

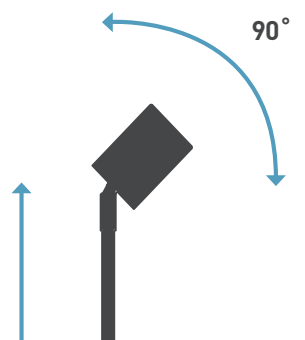

Tilt

Select the best angle to illuminate features.

Move

Simply pick up and move a spike light to illuminate a different feature.

Spike lights.

01604 495 151
collingwoodlighting.com

- @collingwoodLED
- /collingwoodlighting
- collingwoodled

GUARANTEE / WARRANTY

7 year extended warranty

FEATURES & BENEFITS

- High efficacy - up to 144lm/W
- Improved look and feel with single LED
- New stainless steel and anodised bronze finishes
- Higher light output than predecessor
- Low voltage can now run on 700mA drivers
- Reduced body length by 12% for a neat and compact appearance

Beam angle: 40°

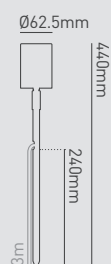
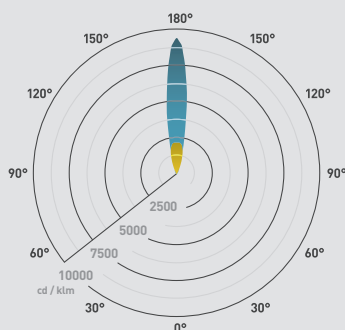

SL220

Low voltage LED spike light

FEATURES

Wattage	2.2W (350mA) 4.6W (700mA)
IP rating	IP65
Colour flexibility	Fixed colour
Tilttable	90°
Input	Driver required (350mA / 700mA)
LED lifetime	70,000h L70 B10
SDCM	3SDCM

INSTALLATION INFORMATION

Bathroom zone	1
Inrush Current	N/A
Construction material	Anodised aluminium Stainless steel 316 Copper
Weight	SL220B / SL220Z: 512g SL220Z: 1301g SL220D: 1000g
Maximum ambient temperature	50°C
SELV	Driver Dependant
Electric class (1, 2, 3)	3

PHOTOMETRICS @ 25°C

Product code	Finish	Colour	Beam angle	CRI	350mA			700mA		
					lm	lm/W	lx at 1m	lm	lm/W	lx at 1m
SL220BWBX40	Black	4000K	40°	>80Ra	310	141	705	530	115	1205
SL220BWBX30	Black	3000K	40°	>80Ra	300	136	682	520	113	1182
SL220BWBX27	Black	2700K	40°	>80Ra	290	132	659	515	112	1171
SL220ZWBX40	Bronze	4000K	40°	>80Ra	310	141	705	530	115	1205
SL220ZWBX30	Bronze	3000K	40°	>80Ra	300	136	682	520	113	1182
SL220ZWBX27	Bronze	2700K	40°	>80Ra	290	132	659	515	112	1171
SL220DWBX30	Stainless steel 316	3000K	40°	>80Ra	300	136	682	520	113	1182
SL220DWBX40	Stainless steel 316	4000K	40°	>80Ra	310	141	705	530	115	1205
SL220DWBX27	Stainless steel 316	2700K	40°	>80Ra	290	132	659	515	112	1171
SL220CWBX27	Copper	2700K	40°	>80Ra	290	132	659	515	112	1171

WIRING INFORMATION

Cable / flying lead	3m H05RN-F rubberised cable (outside diameter: 6mm)
Type of wiring required	Series

LED DRIVERS

Product code	Input	SELV	Dimming	Bathroom zone	Min	Max
PLU/350 1-9	220V-240V	Yes	No	1	1	4
PLR/350 1-5	220V-240V	Yes	No	1	1	3
PLD UNI-DRIVE 700MA	220V-240V	Yes	Yes (1-10V)	2	1	5

ACCESSORIES

JB2 / JB4 / JB6	Waterproof junction box / Gel filled waterproof connectors	Sold separately	422-423
PDC/GRID DIMMER	1-10V dimmer module	Sold separately	422
GH220	Simple hood to reduce glare whilst maintaining a good light distribution	Sold separately	282
GS220	Stylish, baffle-style snoot, perfect for creating a moonlighting effect	Sold separately	282



SL220 MAINS

Straight to mains LED spike light

FEATURES

Wattage	5.7W
IP rating	IP65
Colour flexibility	Fixed colour
Tilttable	90°
Input	Mains AC
LED lifetime	70,000h L70 B10
SDCM	3SDCM

INSTALLATION INFORMATION

Bathroom zone	2
Inrush Current	60A 37µs
Construction material	Anodised aluminium Stainless steel 316 Copper
Weight	SL220B / SL220Z: 550g SL220D: 1037g SL220Z: 550g
Maximum ambient temperature	50°C
SELV	Yes
Electric class (1, 2, 3)	1

PHOTOMETRICS @ 25°C

Product code	Finish	Colour	Beam angle	CRI	lm	lm/W	lx at 1m
SL220BWBM40	Black	4000K	40°	>80Ra	530	93	1205
SL220BWBM30	Black	3000K	40°	>80Ra	520	91	1182
SL220BWBM27	Black	2700K	40°	>80Ra	515	90	1171
SL220ZWBM40	Bronze	4000K	40°	>80Ra	530	93	1205
SL220ZWBM30	Bronze	3000K	40°	>80Ra	520	91	1182
SL220ZWBM27	Bronze	2700K	40°	>80Ra	515	90	1171
SL220DWBM40	Stainless steel 316	4000K	40°	>80Ra	530	93	1205
SL220DWBM30	Stainless steel 316	3000K	40°	>80Ra	520	91	1182
SL220DWBM27	Stainless steel 316	2700K	40°	>80Ra	515	90	1171
SL220CWBM27	Copper	2700K	40°	>80Ra	515	90	1171

WIRING INFORMATION

Cable / flying lead	3m H05RN-F rubberised cable (outside diameter: 7mm)
Type of wiring required	Parallel

LED DRIVERS

Product code	Input	SELV	Dimming	Bathroom zone	Min	Max
N/A (integrated SELV driver)	220V-240V		No	-	-	-

ACCESSORIES

JB5	Gel filled waterproof connector	Sold separately	423
GH220	Simple hood to reduce glare whilst maintaining a good light distribution	Sold separately	282
GS220	Stylish, baffle-style snoot, perfect for creating a moonlighting effect	Sold separately	282

Spike lights.

01604 495 151
collingwoodlighting.com

- @collingwoodLED
- /collingwoodlighting
- collingwoodled

GUARANTEE / WARRANTY

7 year extended warranty

FEATURES & BENEFITS

- High efficacy - up to 93lm/W
- Improved look and feel with single LED
- New stainless steel and anodised bronze finishes
- Higher light output than predecessor
- Mains voltage 700mA as standard
- Reduced body length by 12% for a neat and compact appearance

Beam angle: 40°

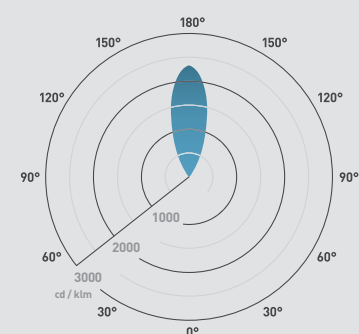

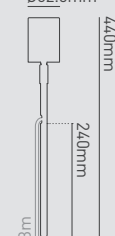

Ø62.5mm



Spike lights.

01604 495 151
collingwoodlighting.com

 @collingwoodLED
 /collingwoodlighting
 collingwoodled

GUARANTEE / WARRANTY

7 year extended warranty

FEATURES & BENEFITS

Supplied with fixtures & fittings

Simple accessories for controlling glare

Can be used on both spike light and wall light families for a consistent outdoor lighting installation

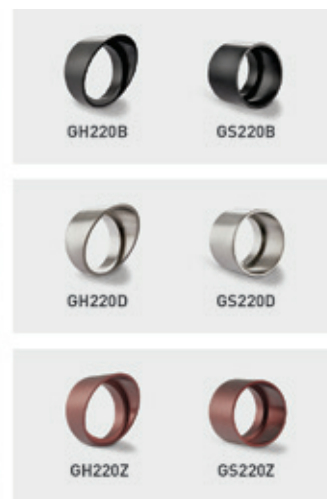
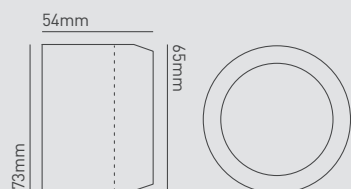
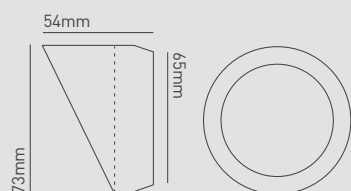

GH220 | GS220

Low-glare, tapered hood | Low-glare, cylindrical snoot

INSTALLATION INFORMATION

Construction material	Anodised aluminium Stainless steel 316
Weight	760g

PRODUCT CODES

Product code	Finish	Description
GH220B	Black	Glare Hood, anodised black
GH220D	Stainless steel 316	Glare Hood, stainless steel 316
GH220Z	Bronze	Glare Hood, anodised bronze
GS220B	Black	Glare Snoot, anodised black
GS220D	Stainless steel 316	Glare Snoot, stainless steel 316
GS220Z	Bronze	Glare Snoot, anodised bronze

USE WITH

SL220	Low voltage LED spike light
SL220 MAINS	Straight to mains LED spike light
SL230	Low voltage LED twin pole spike light
SL230 MAINS	Mains voltage LED twin pole spike light
WL220 MAINS	Straight to mains adjustable LED wall light

Spike lights.

01604 495 151
collingwoodlighting.com

 @collingwoodLED

 /collingwoodlighting

 collingwoodled

GUARANTEE / WARRANTY

7 year extended warranty

FEATURES & BENEFITS

Equivalent to 35W halogen

Long spike included for extra stability

Robust cable for outdoor use

Hooded for reduced glare



SL040A

High output LED spike light

FEATURES

Wattage	7W
IP rating	IP65
Colour flexibility	Fixed colour
Tilttable	90°
Input	Driver required (700mA)
LED lifetime	70,000h L70 B10
SDCM	3SDCM

INSTALLATION INFORMATION

Bathroom zone	1
Inrush Current	N/A
Construction material	Anodised aluminium
Weight	600g
Maximum ambient temperature	35°C
SELV	Yes
Electric class (1, 2, 3)	3

PHOTOMETRICS @ 25°C

Product code	Finish	Colour	Beam angle	CRI	lm	lm/W	lx at 1m
SL040A F NW	Black	4000K	38°	>80Ra	520	74	1471
SL040A S NW	Black	4000K	18°	>80Ra	520	74	4614
SL040A F WW	Black	3000K	38°	>80Ra	413	59	1168
SL040A S WW	Black	3000K	18°	>80Ra	413	59	3665
SL040A F 27	Black	2700K	38°	>80Ra	377	54	1066
SL040A S 27	Black	2700K	18°	>80Ra	377	54	3345

WIRING INFORMATION

Cable / flying lead	3m H05RN-F rubberised cable (outside diameter: 6mm)
Type of wiring required	Series

LED DRIVERS

Product code	Input	SELV	Dimming	Bathroom zone	Min	Max
PLU/700 3-9	220V-240V	Yes	No	1	1	3
PL/IP/700 1-3	220V-240V	Yes	No	1	1	1
PLD UNI-DRIVE 700MA	220V-240V	Yes	Yes (1-10V)	2	1	3

ACCESSORIES

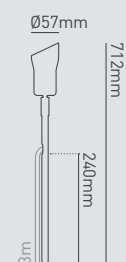
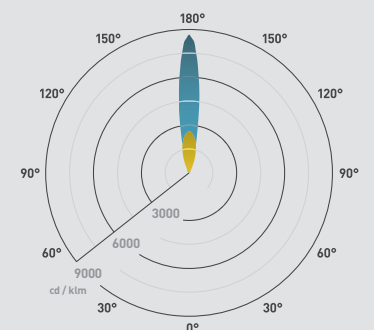

JB2 / JB4 / JB6	Waterproof junction box / Gel filled waterproof connectors	422-423
WCR 275 BLACK	2-core rubber cable	423
PDC/GRID DIMMER	1-10V dimmer module	422

Beam angle: 18° 38°



Spike lights.

01604 495 151
collingwoodlighting.com

-  @collingwoodLED
-  /collingwoodlighting
-  collingwoodled

GUARANTEE / WARRANTY

7 year extended warranty

FEATURES & BENEFITS

- Long spike included for extra stability
- Robust cable for outdoor use
- Small & discreet
- Single point source LED
- IP65 allows for use in exterior spaces



SL030

1W LED spike light

FEATURES

Wattage	1W(350mA) 2W(700mA)
IP rating	IP65
Colour flexibility	Fixed colour
Tilttable	90°
Input	Driver required (350mA / 700mA)
LED lifetime	70,000h L70 B10
SDCM	3SDCM

INSTALLATION INFORMATION

Bathroom zone	1
Inrush Current	N/A
Construction material	Stainless steel (316)
Weight	700g
Maximum ambient temperature	35°C
SELV	N/A
Electric class (1, 2, 3)	3

PHOTOMETRICS @ 25°C

Product code	Finish	Colour	Beam angle	CRI	350mA			700mA		
					lm	lm/W	lx at 1m	lm	lm/W	lx at 1m
SL030 F NW	Stainless steel 316	4000K	26°	>80Ra	95	95	267	140	70	393
SL030 F WW	Stainless steel 316	3000K	26°	>80Ra	75	75	210	135	68	379
SL030 F 27	Stainless steel 316	2700K	26°	>80Ra	70	70	196	120	60	337
SL030 F AMBER	Stainless steel 316	Amber	26°	-	-	-	-	-	-	-
SL030 F BLUE	Stainless steel 316	Blue	26°	-	-	-	-	-	-	-
SL030 F GREEN	Stainless steel 316	Green	26°	-	-	-	-	-	-	-
SL030 F RED	Stainless steel 316	Red	26°	-	-	-	-	-	-	-

Beam angle: 26°

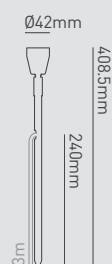
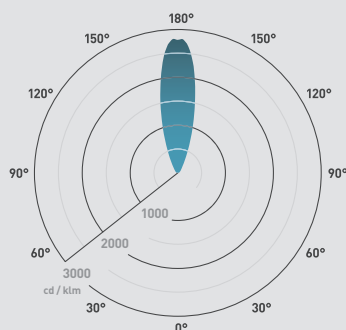

WIRING INFORMATION

Cable / flying lead	3m H05RN-F rubberised cable (outside diameter: 6mm)
Type of wiring required	Series

LED DRIVERS

Product code	Input	SELV	Dimming	Bathroom zone	Min	Max
PLU/350 1-9	220V-240V	Yes	No	1	1	9
PLR/350 1-5	220V-240V	Yes	No	1	1	5
PLD UNI-DRIVE 700MA	220V-240V	Yes	Yes (1-10V)	2	1	10

ACCESSORIES

JB2 / JB4 / JB6	Waterproof junction box / Gel filled waterproof connectors	Sold separately	422-423
WCR 275 BLACK	2-core rubber cable	Sold separately	423
PDC/GRID DIMMER	1-10V dimmer module	Sold separately	422

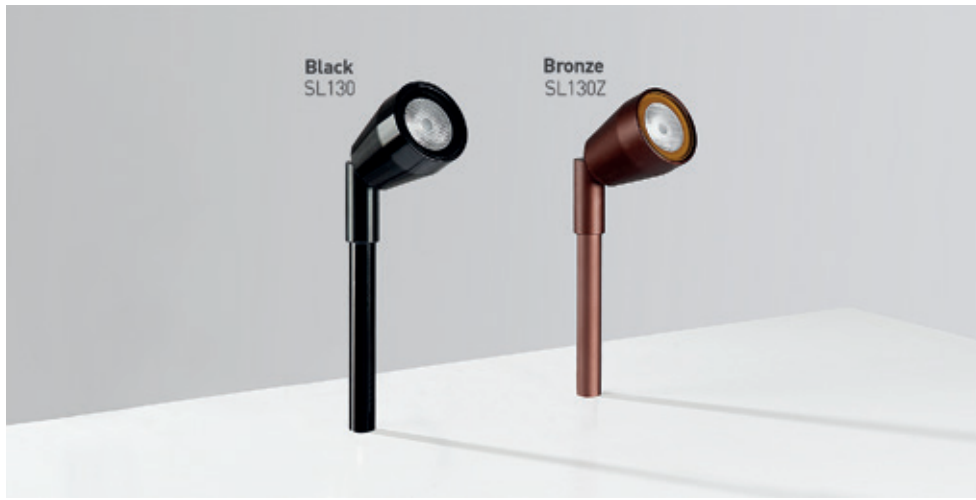

SL130

1W LED spike light

FEATURES

Wattage	1W(350mA) 2W(700mA)
IP rating	IP65
Colour flexibility	Fixed colour
Tilttable	90°
Input	Driver required (350mA / 700mA)
LED lifetime	70,000h L70 B10
SDCM	3SDCM

INSTALLATION INFORMATION

Bathroom zone	1
Inrush Current	N/A
Construction material	Anodised aluminium
Weight	405g
Maximum ambient temperature	35°C
SELV	N/A
Electric class [1, 2, 3]	3

PHOTOMETRICS @ 25°C

Product code	Finish	Colour	Beam angle	CRI	350mA			700mA		
					lm	lm/W	lx at 1m	lm	lm/W	lx at 1m
SL13040	Black	4000K	26°	>80Ra	95	95	267	140	70	393
SL13030	Black	3000K	26°	>80Ra	75	75	210	135	68	379
SL13027	Black	2700K	26°	>80Ra	70	70	196	120	60	337
SL130ZMBX40	Bronze	4000K	26°	>80Ra	95	95	267	140	70	393
SL130ZMBX30	Bronze	3000K	26°	>80Ra	75	75	210	135	68	379
SL130ZMBX27	Bronze	2700K	26°	>80Ra	70	70	196	120	60	337

WIRING INFORMATION

Cable / flying lead	3m H05RN-F rubberised cable (outside diameter: 6mm)
Type of wiring required	Series

LED DRIVERS

Product code	Input	SELV	Dimming	Bathroom zone	Min	Max
PLU/350 1-9	220V-240V	Yes	No	1	1	9
PLR/350 1-5	220V-240V	Yes	No	1	1	5
PLD UNI-DRIVE 700MA	220V-240V	Yes	Yes (1-10V)	2	1	10

ACCESSORIES

JB2 / JB4 / JB6	Waterproof junction box / Gel filled waterproof connectors	Sold separately	422-423
WCR 275 BLACK	2-core rubber cable	Sold separately	423
PDC/GRID DIMMER	1-10V dimmer module	Sold separately	422

Spike lights.

01604 495 151
collingwoodlighting.com

- @collingwoodLED
- /collingwoodlighting
- collingwoodled

GUARANTEE / WARRANTY

7 year extended warranty

FEATURES & BENEFITS

- Long spike included for extra stability
- Robust cable for outdoor use
- Small & discreet
- IP65 allows for use in exterior spaces

Beam angle: 26°

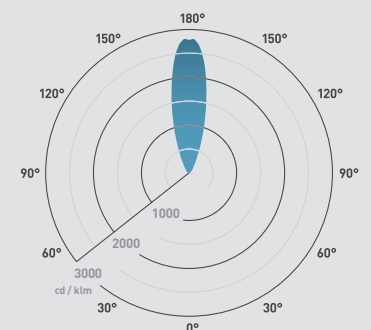

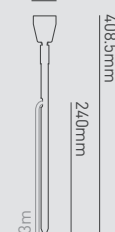

Ø42mm



Spike lights.

01604 495 151
collingwoodlighting.com

-  @collingwoodLED
-  /collingwoodlighting
-  collingwoodled

GUARANTEE / WARRANTY

7 year extended warranty

FEATURES & BENEFITS

Adjustable bar-mounted twin heads, ideal for discreet illumination of shrubbery, trees and other landscape features

Easily ground mounted with two spikes and single cable for quick installation

Elegant and discreet black and bronze finishes

Available in both low voltage and mains voltage

Highly efficient: up to 114lm/W

Beam angle: 40°

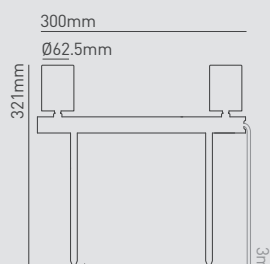
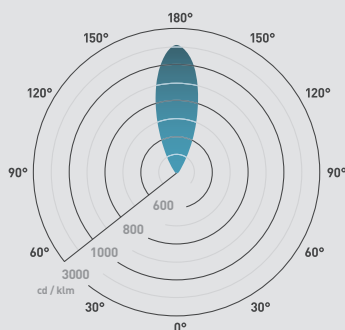

SL240

Low voltage LED twin bar spike light

FEATURES

Wattage	4.4W (350mA) 9.2W (700mA)
IP rating	IP65
Colour flexibility	Fixed colour
Tilttable	90°
Rotatable	330°
Input	Driver required (350mA / 700mA)
LED lifetime	70,000h L70 B10
SDCM	3SDCM

INSTALLATION INFORMATION

Bathroom zone	2
Inrush Current	N/A
Construction material	Anodised aluminium
Weight	1414g
Maximum ambient temperature	35°C
SELV	N/A
Electric class (1, 2, 3)	3

PHOTOMETRICS @ 25°C

Product code	Finish	Colour	Beam angle	CRI	350mA			700mA		
					lm	lm/W	lx at 1m	lm	lm/W	lx at 1m
SL240BWBX40	Black	4000K	40°	>80Ra	620	144	2X 705	1060	114	2X 1205
SL240BWBX30	Black	3000K	40°	>80Ra	600	140	2X 682	1040	112	2X 1182
SL240BWBX27	Black	2700K	40°	>80Ra	580	135	2X 659	1030	111	2X 1171
SL240ZWBX40	Bronze	4000K	40°	>80Ra	620	144	2X 705	1060	114	2X 1205
SL240ZWBX30	Bronze	3000K	40°	>80Ra	600	140	2X 682	1040	112	2X 1182
SL240ZWBX27	Bronze	2700K	40°	>80Ra	580	135	2X 659	1030	111	2X 1171

WIRING INFORMATION

Cable / flying lead	3m H05RN-F rubberised cable (outside diameter: 6mm)
Type of wiring required	Series

LED DRIVERS

Product code	Input	SELV	Dimming	Bathroom zone	Min	Max
PLU/350 1-9	220V-240V	Yes	No	1	1	2
PLD UNI-DRIVE 700MA	220V-240V	Yes	Yes (1-10V)	1	1	3



ACCESSORIES

JB2 / JB4 / JB6	Waterproof junction box / Gel filled waterproof connectors	Sold separately	422-423
GH220	Simple hood to reduce glare whilst maintaining a good light distribution	Sold separately	282
GS220	Simple snoot to reduce glare whilst maintaining a good light distribution	Sold separately	282



Spike lights.

01604 495 151
collingwoodlighting.com

-  @collingwoodLED
-  /collingwoodlighting
-  collingwoodled

SL240

Mains voltage LED twin bar spike light

FEATURES

Wattage	11.4W
IP rating	IP65
Colour flexibility	Fixed colour
Tilttable	90°
Rotatable	330°
Input	Mains AC
LED lifetime	70,000h L70 B10
SDCM	3SDCM

INSTALLATION INFORMATION

Bathroom zone	2
Inrush Current	120A 37µs
Construction material	Anodised aluminium
Weight	1401g
Maximum ambient temperature	35°C
SELV	Yes
Electric class [1, 2, 3]	2

GUARANTEE / WARRANTY

7 year extended warranty

FEATURES & BENEFITS

Adjustable bar-mounted twin heads, ideal for discreet illumination of shrubbery, trees and other landscape features

Easily ground mounted with two spikes and single cable for quick installation

Elegant and discreet black and bronze finishes

Available in both low voltage and mains voltage

Highly efficient: up to 93lm/W

PHOTOMETRICS @ 25°C

Product code	Finish	Colour	Beam angle	CRI	lm	lm/W	lx at 1m
SL240BWBM40	Black	4000K	40°	>80Ra	1060	93	2X 1205
SL240BWBM30	Black	3000K	40°	>80Ra	1040	91	2X 1182
SL240BWBM27	Black	2700K	40°	>80Ra	1030	90	2X 1171
SL240ZWBM40	Bronze	4000K	40°	>80Ra	1060	93	2X 1205
SL240ZWBM30	Bronze	3000K	40°	>80Ra	1040	91	2X 1182
SL240ZWBM27	Bronze	2700K	40°	>80Ra	1030	90	2X 1171

WIRING INFORMATION

Cable / flying lead	3m H05RN-F rubberised cable (outside diameter: 7mm)
Type of wiring required	Parallel

LED DRIVERS

Product code	Input	SELV	Dimming	Bathroom zone	Min	Max
N/A (integrated SELV driver)	220V-240V	Yes	No	2	-	-

ACCESSORIES

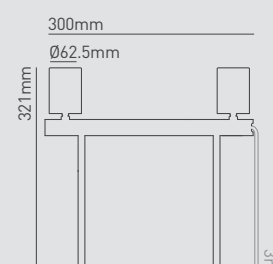
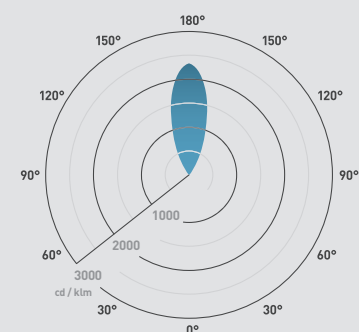

JB5	Gel filled waterproof connector	Sold separately	423
GH220	Simple hood to reduce glare whilst maintaining a good light distribution	Sold separately	282
GS220	Simple snoot to reduce glare whilst maintaining a good light distribution	Sold separately	282

Beam angle: 40°



Spike lights.

01604 495 151
collingwoodlighting.com

-  @collingwoodLED
-  /collingwoodlighting
-  collingwoodled

GUARANTEE / WARRANTY

7 year extended warranty

FEATURES & BENEFITS

Adjustable pole-mounted twin heads are perfect for illuminating paths, steps and trees

Easily ground mounted with spiked pole and single cable for quick installation

Elegant and discreet black and bronze finishes

Available in both low voltage and mains voltage

Highly efficient: up to 114lm/W

Beam angle: 40°

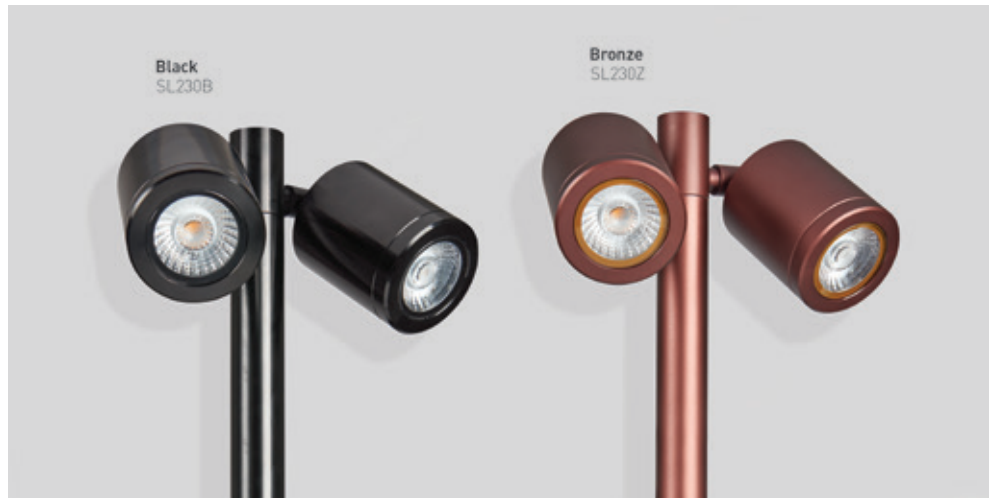
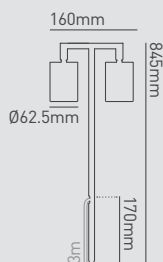
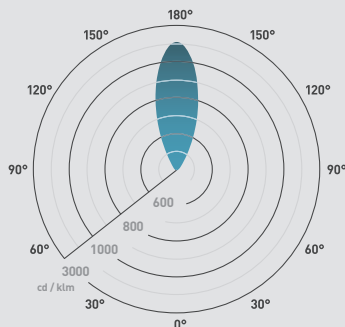

SL230

Low voltage LED twin pole spike light

FEATURES

Wattage	4.4W (350mA) 9.2W (700mA)
IP rating	IP65
Colour flexibility	Fixed colour
Tilttable	90°
Rotatable	330°
Input	Driver required (350mA / 700mA)
LED lifetime	70,000h L70 B10
SDCM	3SDCM

INSTALLATION INFORMATION

Bathroom zone	2
Inrush Current	N/A
Construction material	Anodised aluminium
Weight	1401g
Maximum ambient temperature	35°C
SELV	N/A
Electric class (1, 2, 3)	3

PHOTOMETRICS @ 25°C

Product code	Finish	Colour	Beam angle	CRI	350mA			700mA		
					lm	lm/W	lx at 1m	lm	lm/W	lx at 1m
SL230BWBX40	Black	4000K	40°	>80Ra	620	144	2X 705	1060	114	2X 1205
SL230BWBX30	Black	3000K	40°	>80Ra	600	140	2X 682	1040	112	2X 1182
SL230BWBX27	Black	2700K	40°	>80Ra	580	135	2X 659	1030	111	2X 1171
SL230ZWBX40	Bronze	4000K	40°	>80Ra	620	144	2X 705	1060	114	2X 1205
SL230ZWBX30	Bronze	3000K	40°	>80Ra	600	140	2X 682	1040	112	2X 1182
SL230ZWBX27	Bronze	2700K	40°	>80Ra	580	135	2X 659	1030	111	2X 1171

WIRING INFORMATION

Cable / flying lead	3m H05RN-F rubberised cable (outside diameter: 6mm)
Type of wiring required	Series

LED DRIVERS

Product code	Input	SELV	Dimming	Bathroom zone	Min	Max
PLU/350 1-9	220V-240V	Yes	No	1	1	2
PLD UNI-DRIVE 700MA	220V-240V	Yes	Yes (1-10V)	1	1	3

ACCESSORIES

JB2 / JB4 / JB6	Waterproof junction box / Gel filled waterproof connectors	Sold separately	422-423
GH220	Simple hood to reduce glare whilst maintaining a good light distribution	Sold separately	282
GS220	Simple snoot to reduce glare whilst maintaining a good light distribution	Sold separately	282

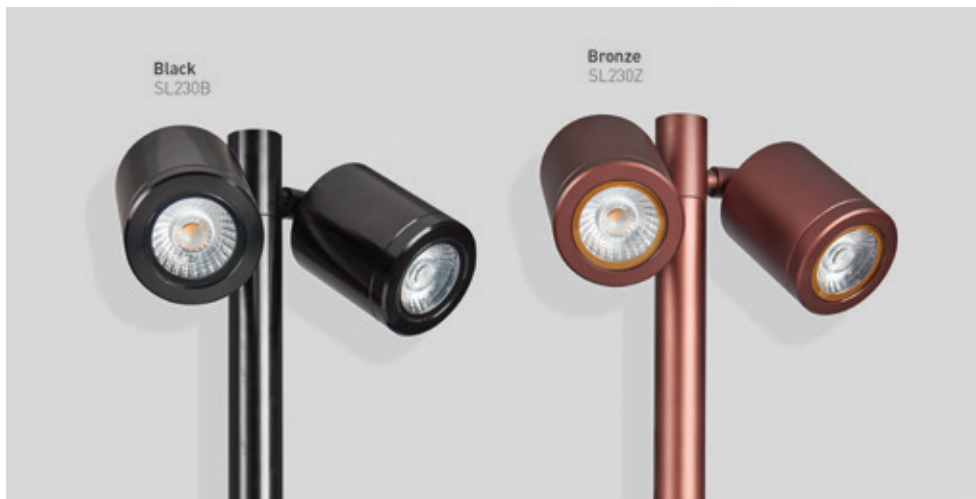

SL230

Mains voltage LED twin pole spike light

FEATURES

Wattage	11.4W
IP rating	IP65
Colour flexibility	Fixed colour
Tilttable	90°
Rotatable	330°
Input	Mains AC
LED lifetime	70,000h L70 B10
SDCM	3SDCM

INSTALLATION INFORMATION

Bathroom zone	2
Inrush Current	120A 37µs
Construction material	Anodised aluminium
Weight	1577g
Maximum ambient temperature	35°C
SELV	Yes
Electric class [1, 2, 3]	2

PHOTOMETRICS @ 25°C

Product code	Finish	Colour	Beam angle	CRI	lm	lm/W	lx at 1m
SL230BWB40	Black	4000K	40°	>80Ra	1060	93	2X 1205
SL230BWB30	Black	3000K	40°	>80Ra	1040	91	2X 1182
SL230BWB27	Black	2700K	40°	>80Ra	1030	90	2X 1171
SL230ZWB27	Bronze	2700K	40°	>80Ra	1030	90	2X 1171
SL230ZWB30	Bronze	3000K	40°	>80Ra	1040	91	2X 1182
SL230ZWB40	Bronze	4000K	40°	>80Ra	1060	93	2X 1205

WIRING INFORMATION

Cable / flying lead	3m H05RN-F rubberised cable (outside diameter: 7mm)
Type of wiring required	Parallel

LED DRIVERS

Product code	Input	SELV	Dimming	Bathroom zone	Min	Max
N/A (integrated SELV driver)	220V-240V	Yes	No	2	-	-

ACCESSORIES

JB5	Gel filled waterproof connector	Sold separately	423
GH220	Simple hood to reduce glare whilst maintaining a good light distribution	Sold separately	282
GS220	Simple snoot to reduce glare whilst maintaining a good light distribution	Sold separately	282

Spike lights.

01604 495 151
collingwoodlighting.com

- @collingwoodLED
- /collingwoodlighting
- collingwoodled

GUARANTEE / WARRANTY

7 year extended warranty

FEATURES & BENEFITS

Adjustable pole-mounted twin heads are perfect for illuminating paths, steps and trees

Easily ground mounted with spiked pole and single cable for quick installation

Elegant and discreet black and bronze finishes

Available in both low voltage and mains voltage

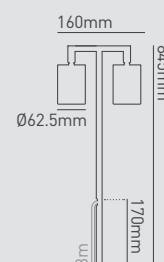
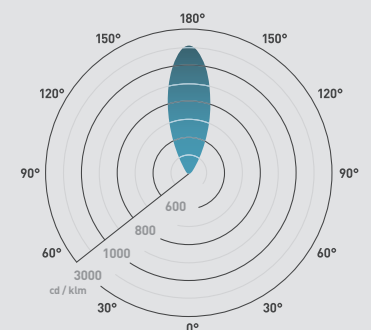

Highly efficient: up to 93lm/W

Beam angle: 40°



Spike lights.

01604 495 151
collingwoodlighting.com

 @collingwoodLED
 /collingwoodlighting
 collingwoodled

GUARANTEE / WARRANTY

7 year extended warranty

FEATURES & BENEFITS

Low voltage product
Robust cable for outdoor use
Long lifetime of 70,000hrs



SL250

Low voltage LED path light with spike

FEATURES

Wattage	4W
IP rating	IP65
Colour flexibility	Fixed colour
Tilttable	N/A
Rotatable	N/A
Input	Driver required (24V)
LED lifetime	50,000h L70 B10
SDCM	6SDCM

INSTALLATION INFORMATION

Bathroom zone	1
Inrush Current	N/A
Construction material	Brass, copper or powder coated aluminium
Weight	1390g
Maximum ambient temperature	35°C
SELV	N/A
Electric class (1, 2, 3)	3

PHOTOMETRICS @ 25°C

Product code	Finish	Colour	Beam angle	CRI	lm	lm/W	lx at 1m
SL250BPX0X40	Black power coated aluminium	4000K	60-110°	>80Ra	240	60	182 / 82
SL250BPX0X30	Black power coated aluminium	3000K	60-110°	>80Ra	220	55	167 / 75
SL250BPX0X27	Black power coated aluminium	2700K	60-110°	>80Ra	200	50	152 / 68
SL250ATX0X27	Brass, treated	2700K	60-110°	>80Ra	200	50	152 / 68
SL250ATX0X30	Brass, treated	3000K	60-110°	>80Ra	220	55	167 / 75
SL250ATX0X40	Brass, treated	4000K	60-110°	>80Ra	240	60	182 / 82
SL250CTX0X27	Copper, treated	2700K	60-110°	>80Ra	200	50	152 / 68

WIRING INFORMATION

Cable / flying lead	1m H05RN-F rubberised cable (outside diameter: 6mm)
Type of wiring required	Parallel

LED DRIVERS

Product code	Input	SELV	Dimming	Bathroom zone	Min	Max
PS1524	220V-240V	Yes	Yes (with PDCINT 1-10V)	-	1	3
PS3024B	220V-240V	Yes	Yes (with PDCINT 1-10V)	-	1	7
PS7524	220V-240V	Yes	Yes (with PDCINT 1-10V)	-	1	18

ACCESSORIES

JB1 / JB5 / JB6	Waterproof junction box / Gel filled waterproof connectors	Sold separately	422-423
WCR 275 BLACK	2-core rubber cable	Sold separately	423

Beam angle: 60-110°

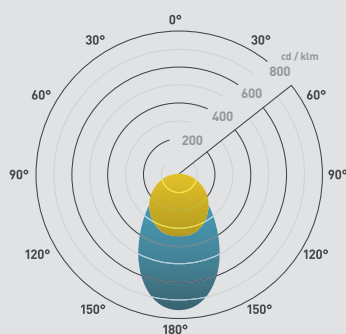

Spike lights.

01604 495 151
collingwoodlighting.com

 @collingwoodLED

 /collingwoodlighting

 collingwoodled

GUARANTEE / WARRANTY

7 year extended warranty

FEATURES & BENEFITS

Quality brushed aluminium finish



SL250A1

Path light surface mount accessory

INSTALLATION INFORMATION

Construction material	Powder coated aluminium
Weight	138g

PRODUCT CODES

Product codes	Description
SL250A1	SL250 Black Powder Coated Aluminium Base Plate Accessory

USE WITH

SL250	Low voltage LED path light with spike
-------	---------------------------------------

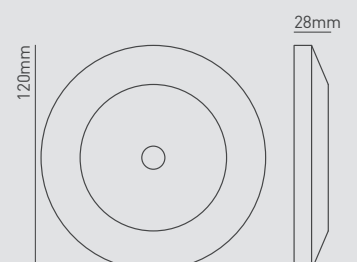

Bespoke wooden bollards.

Create beautifully lit paths and driveways



Adding style and flair to any design scheme, bollards can add depth and dimension to a landscape, creating safer, 24-hour spaces.

Single LED bollard

Use the single LED bollard to add new lighting to existing pathways, gardens or shared spaces. The remote SELV power supply provides increased flexibility when fitting. Long distances of cable can be concealed within trunking.

Bollards are often purposely positioned in a uniformed capacity to highlight a walkway; however, they can also be integrated into a landscape feature, maximising the overall design of the space.



For a pathway with consistent points highlighted:

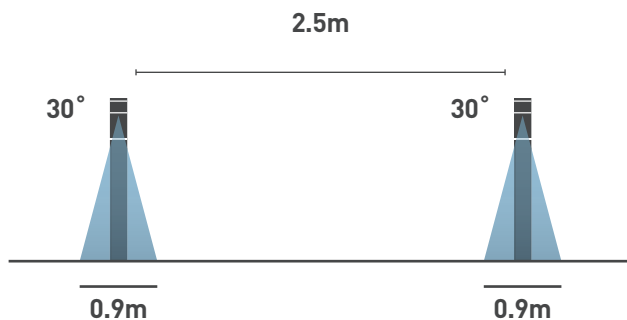

Triple LED bollard

Using an integral power supply, this direct to mains bollard is ideal for replacing existing bollard lighting, which may be looking tired or in need of replacement. It is easy to replace using existing cables or as part of a new build, where cables can easily be installed with minimum impact. Using three LEDs instead of one and with a wider beam angle, these products are capable of being positioned at greater distances whilst still creating an even spread of light.



For a pathway consistently lit at 30 lux:

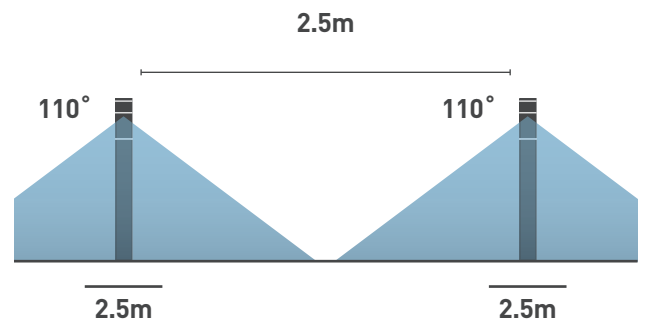

Choice of material

Choose from three beautifully crafted woods to obtain the ideal aesthetic for your bollard.

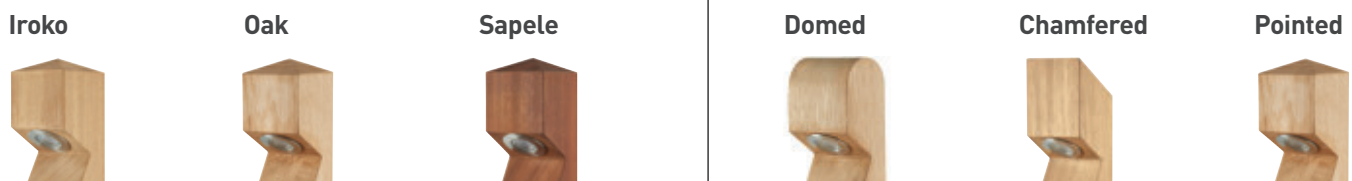

Choice of style

Choose from three unique styles to suit your installation.

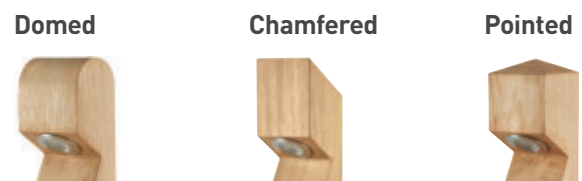

Colour temperature

Choose between three available colour temperatures.



Choosing the ideal bollard.

For your installation

Use the five easy steps below to ascertain the perfect bollard for your installation.

1

Do you prefer a bollard with single or triple LEDs?

Single LED bollard

Beam angle : 30°



Triple LED bollard

Beam angle : 110°



2

Which style head would you like?

Domed



Chamfered



Pointed



3

Which type of wood do you prefer?

Iroko



Oak



Sapele



4

Will the bollard be recessed or surface mounted?

Recessed mount

Side cable entry is required for recess mounting.



Surface mount

Base cable entry is required for surface mounting.



When surface mounting you will also need a bracket.



Partcode: BOL LED BRACKET

5

Which colour temperature do you need?

Warmest

For a warm cosy look use 2700K.



Warm

For the warmth of a halogen use 3000K.



Natural white

For a more neutral look use 4000K.



Now you've determined what you'll need, use the tables on the next page to obtain the correct partcode.

Choosing the ideal wooden bollard.

For your installation

Now you know what attributes you want, use the matrix below to work out which partcode you need.

Use the generator below to build your wooden bollards partcode based on the attributes you have selected.

The example shown is for a single LED with base cable entry, 2700K, iroko wood, domed head bollard, resulting in the partcode BL01DIB27. You can change each element to represent the bollard you need.



1 Product type

BL Bollard

2 Single / triple LED

01 Single LED

03 Triple LED

3 Style

D Domed

F Chamfered

P Pointed

4 **I** | **5** **B** | **6** **2 7**
0 | **S** | **3 0**
S | | **4 0**

4 **Material**

- I** Iroko wood
- O** Oak wood
- S** Sapele wood

5 **Cable entry**



- B** Base entry
- S** Side entry

6 **Colour temperature**

- 27** 2700K
- 30** 3000K
- 40** 4000K

Bollards.

01604 495 151
collingwoodlighting.com

-  @collingwoodLED
-  /collingwoodlighting
-  collingwoodled

GUARANTEE / WARRANTY

7 year extended warranty

FEATURES & BENEFITS

- Choice of wood finishes: Iroko, Sapele or Oak
- Pointed, Chamfered or Domed top
- Choice of low-voltage or straight-to-mains
- Side-entry cable or base-entry cable options
- Three colour temperature options: 2700K, 3000K or 4000K



BOL LED

Straight to mains, Hand crafted and bespoke wooden bollard

FEATURES

Wattage	5W
IP rating	IP65
Colour flexibility	Fixed colour
Input	Mains AC
LED lifetime	70,000h L70 B10
SDCM	3SDCM

INSTALLATION INFORMATION

Bathroom zone	2
Inrush current	17.9A 0.1ms
Construction material	See page 294-295
Weight	5500g
Maximum ambient temperature	35°C
SELV	N/A (Integrated SELV driver)
Electric class (1, 2, 3)	2

PHOTOMETRICS @ 25°C

Product code	Colour	Beam angle	CRI	lm	lm/W	lx at 1m
See page 294-295	4000K	110°	>80Ra	246	49	104
	3000K	110°	>80Ra	160	32	80
	2700K	110°	>80Ra	156	31	78

WIRING INFORMATION

Cable / flying lead	NEW 1.5mm SY 2 Core PVC Steel Braid Cable
Type of wiring required	Parallel

LED DRIVERS

Product code	Input	SELV	Dimming	Bathroom zone	Min	Max
N/A (integrated SELV driver)	-	-	-	N/A	N/A	N/A

ACCESSORIES

BOL LED BRACKET	Stainless steel bracket for BOL LED range	Sold separately	298
JB5	Gel filled junction box	Sold separately	423

Beam angle: 110°

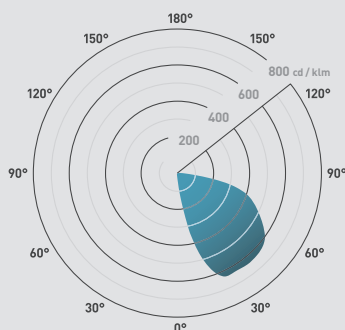

Recessed mount

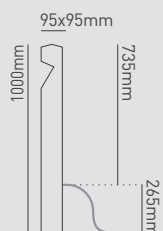

Surface mount

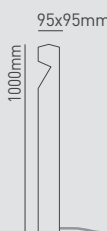



Bollards.

01604 495 151
collingwoodlighting.com

@collingwoodLED

/collingwoodlighting

collingwoodled

BOL LED

Hand crafted and bespoke wooden bollard

FEATURES

Wattage	1W
IP rating	IP65
Colour flexibility	Fixed colour
Input	350mA
LED lifetime	70,000h L70 B10
SDCM	3SDCM

INSTALLATION INFORMATION

Bathroom zone	1
Inrush current	-
Construction material	See page 294-295
Weight	5800g
Maximum ambient temperature	35°C
SELV	-
Electric class (1, 2, 3)	3

PHOTOMETRICS @ 25°C

Product code	Colour	Beam angle	CRI	lm	lm/W	lx at 1m
See page 294-295	4000K	26°	>80Ra	95	95	267
	3000K	26°	>80Ra	75	75	210
	2700K	26°	>80Ra	70	70	204

WIRING INFORMATION

Cable / flying lead	1.8m (H05RN-F) rubberised cable (outside diameter: 6mm)
Type of wiring required	Series

LED DRIVERS

Product code	Input	SELV	Dimming	Bathroom zone	Min	Max
PLU/350 1-9	350mA	Yes	No	N/A	1	9
PLR/350 1-5	350mA	Yes	No	N/A	1	5
PLD UNI-DRIVE 350mA	350mA	Yes	Yes (1-10V)	N/A	1	10

ACCESSORIES

BOL LED BRACKET	Stainless steel bracket for BOL LED range	Sold separately	298
JB2 / JB4 / JB6	Waterproof junction box / Gel filled waterproof connectors	Sold separately	422-423
WCR 275 BLACK	2-core rubber cable	Sold separately	423

GUARANTEE / WARRANTY

7 year extended warranty

FEATURES & BENEFITS

Choice of wood finishes: Iroko, Sapele or Oak
Pointed, Chamfered or Domed top
Choice of low-voltage or straight-to-mains
Side-entry cable or base-entry cable options
Three colour temperature options: 2700K, 3000K or 4000K

Beam angle: 26°

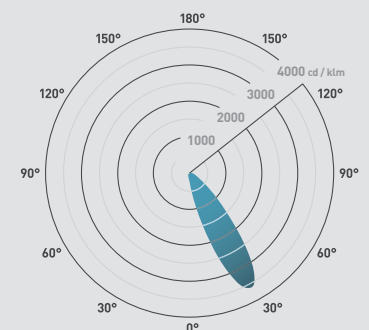

Recessed mount

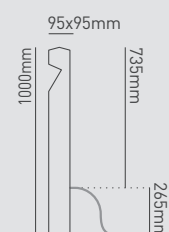

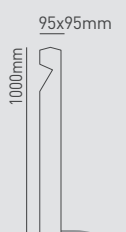

Surface mount



Bollards.

01604 495 151
collingwoodlighting.com

-  @collingwoodLED
-  /collingwoodlighting
-  collingwoodled

GUARANTEE / WARRANTY

1 year extended warranty

FEATURES & BENEFITS

Supplied with stainless steel fixtures & fittings



BOL LED BRACKET

Stainless steel bracket for BOL LED range

FEATURES

Construction material	Stainless steel (304)
Weight	1780g

PRODUCT CODE

Product code	Description
BOLBRACKET	Stainless steel bracket for BOL LED range

USE WITH

BOL LED 1	Hand crafted and bespoke wooden bollard	Sold separately
BOL LED 030 MAINS	Straight to mains, Hand crafted and bespoke wooden bollard	Sold separately

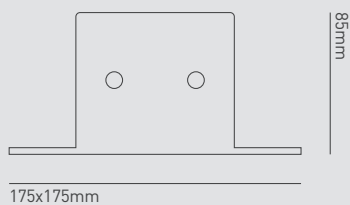



Commercial.

Used in offices, hospitals and retail outlets, commercial lighting has to be functional, durable and serve the appropriate purposes. Consider the illumination of the space and the lux levels required. Consuming less power and having a much greater operating life than that of its more traditional competitors, LED lighting is being quickly adopted in this sector and rapidly proving numerous benefits.

Lighting in commercial spaces can have a huge impact on productivity, morale and basic health and safety. Fitting the correct lighting is massively important in creating a safe and comfortable working environment for all occupants. Not only can LED lighting offer financial, environmental and health benefits, it also allows a space to be controlled easily with the use of dimmers, sensors and smartphone devices. Collingwood's range of commercial lighting caters for all environments and is the ideal solution for your installation.



Solis.

Panels

The Solis range brings all the benefits of low glare LED technology to a commercial space.

Commercial panels

The addition of LED panels to the Collingwood collection means we can now provide a complete solution for your commercial lighting projects. Available in three different sizes, the new Solis range brings all the benefits of LED lighting to a conventional ceiling panel. Ideal for large open-plan commercial areas such as offices, shops, reception areas, schools and universities. All of our panels are back-lit, available in 30W, 40W and 60W options, and both TP(a) and TP(b) options. With a high efficacy of 110lm/W the Solis panels will provide cost and energy savings.

1200 x 600 mm



1200 x 300 mm



600 x 600 mm



Low UGR

Available in both ≤ 19 and ≤ 22 UGR ratings, these products are low glare and the UGR ≤ 19 options are in keeping with Chartered Institution of Building Services Engineers (CIBSE) recommendations. Suitable for office environments where reading, writing, meetings and computer-based work takes place.

UGR 19

UGR 22

Flicker-free

In line with Collingwood values, the best electrical components have been included in the product design. This has resulted in our confidence to assert that the panels are flicker free fittings.

Having flicker free panels result in a more comfortable working environment and increases employee satisfaction and productivity.



IP40

The build quality of our panel range ensures that they are IP40 rated as standard, making them suitable for indoor commercial uses, such as offices, receptions and education establishments.



Dimming options

A choice of two dimming options are available, DALI-2 or 1-10V.

The DALI-2 offers the flexibility for even the largest of applications, and the 1-10V is ideal for retro fitting into applications.

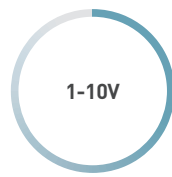

5 year extended warranty

A 5 year extended warranty is available for that added peace of mind.



Which mounting method?

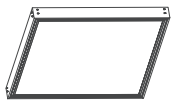
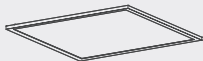

The surface mount frame is an ideal solution to mount panels in places without suspended ceiling grids and where recessed mounting is not possible. The frame screws easily into the ceiling and the panel will slide into the frame, with the remaining side screws on to finalise the installation.

The suspension kit allows the panel to be suspended from a ceiling, which is ideal for situations where recessed mounting is not possible. Installation is quick and easy – simply screw one end to the ceiling while the other side loops through the brackets supplied.

Which mounting method?	Product	Kit required for 600 x 600 mm	Kit required for 1200 x 300 mm	Kit required for 1200 x 600 mm
Suspended To suspend from ceiling	 Suspension kit	P1SK 2 x Suspensions supplied	P1SK 2 x Suspensions supplied	P1SKC 3 x Suspensions supplied
Surface To mount onto a solid surface	 Surface mount kit	P2SMA	P2SMB	P2SMC
Recessed To mount to a ceiling	 Panel	-	-	-

Panels.

01604 495 151
collingwoodlighting.com

-  @collingwoodLED
-  /collingwoodlighting
-  collingwoodled

GUARANTEE / WARRANTY

5 year extended warranty

FEATURES & BENEFITS

Low glare for visual comfort

Each panel is compatible with our three hour non-maintained emergency pack

Installation is quick and easy

Various sizes available

Available in both TP(a) and TP (b) to suit your preference

Suitable for reading, writing, meetings and computer-based work

Supplied with 1m long safety steel cable

Glow wire test:
P2 panels - 650°C
P3 panels - 850°C

Beam angle: 90° 110°

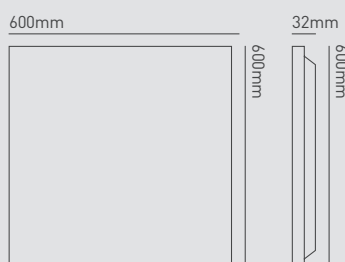
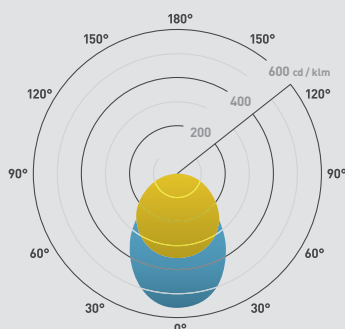

Solis 600X600

600 x 600 LED panel

FEATURES

Wattage	30W 40W
IP rating	IP40
IK rating	IK06
UGR	<19 22
Sensor	No
Dimmable	DALI 2 1-10V
Input	220-240V
LED lifetime	50,000h
SDCM	6SDCM
Flicker free	Yes
Emergency version available	Yes, using CWD LEDEP09 (sold separately)

INSTALLATION INFORMATION

Install connector type	Integrated terminals
Insulation coverable	(Yes, contact us at 01604 495 151)
Inrush current	50A, 0.05ms
Construction material	PS(P2) / PC(P3) Aluminium Painted steel
Weight	UGR19: 2025g UGR22: 1750g
Maximum ambient temperature	40°
SELV	Yes
Building regulations	Part P & L
Electric class (1, 2, 3)	2

PHOTOMETRICS @ 25°C

Product code	Wattage	Dimming	UGR	Colour	Beam angle	CRI	lm	lm/W	lx at 1m
P2A19S30W	30W	Non-Dim	UGR19 TP(a)	4000K	90°	>80Ra	3300	110	1582
P2A19S40W	40W	Non-Dim	UGR19 TP(a)	4000K	90°	>80Ra	4400	110	2099
P3A19D30W	30W	DALI 2	UGR19 TP(a)	4000K	90°	>80Ra	3300	110	1582
P3A19D40W	40W	DALI 2	UGR19 TP(a)	4000K	90°	>80Ra	4400	110	2099
P3A19V30W	30W	1-10V	UGR19 TP(a)	4000K	90°	>80Ra	3300	110	1582
P3A19V40W	40W	1-10V	UGR19 TP(a)	4000K	90°	>80Ra	4400	110	2099
P2A22S30W	30W	Non-Dim	UGR22 TP(b)	4000K	110°	>80Ra	3300	110	1140
P2A22S40W	40W	Non-Dim	UGR22 TP(b)	4000K	110°	>80Ra	4400	110	1511
P2A22D30W	30W	DALI 2	UGR22 TP(b)	4000K	110°	>80Ra	3300	110	1140
P2A22D40W	40W	DALI 2	UGR22 TP(b)	4000K	110°	>80Ra	4400	110	1511
P2A22V30W	30W	1-10V	UGR22 TP(b)	4000K	110°	>80Ra	3300	110	1140
P2A22V40W	40W	1-10V	UGR22 TP(b)	4000K	110°	>80Ra	4400	110	1511

WIRING INFORMATION

Cable / flying lead	0.75-1.5mm ²
Type of wiring required	Parallel

ACCESSORIES

LEDEP09	3hr non-maintained emergency pack	Sold separately	315
P1SK	Suspension kit for 600 x 600 & 1200 x 300 Panels.	Sold separately	307
P2SMA	Surface mount kit for 600 x 600 LED panel	Sold separately	307

Panels.

01604 495 151
collingwoodlighting.com

 @collingwoodLED

 /collingwoodlighting

 collingwoodled

GUARANTEE / WARRANTY

5 year extended warranty

FEATURES & BENEFITS

Low glare for visual comfort

Each panel is compatible with our three hour non-maintained emergency pack

Installation is quick and easy

Various sizes available

Available in both TP(a) and TP (b) to suit your preference

Suitable for reading, writing, meetings and computer-based work

Supplied with 1m long safety steel cable

Glow wire test:
P2 panels - 650°C
P3 panels - 850°C



Solis 1200X300

1200 x 300 LED panel

FEATURES

Wattage	30W
IP rating	IP40
IK rating	IK06
UGR	<19
Sensor	No
Dimmable	DALI 2 1-10V
Input	220-240V
LED lifetime	50,000h
SDCM	6SDCM
Flicker free	Yes
Emergency version available	Yes, using CWD LEDEP09 (sold separately)

INSTALLATION INFORMATION

Install connector type	Integrated terminals
Insulation coverable	(Yes, contact us at 01604 495 151)
Inrush current	50A, 0.05ms
Construction material	PS(P2) / PC(P3) Aluminium Painted steel
Weight	UGR19: 2125g UGR22: 1800g
Maximum ambient temperature	40°
SELV	Yes
Building regulations	Part P & L
Electric class (1, 2, 3)	2

PHOTOMETRICS @ 25°C

Product code	Wattage	Dimming	UGR	Colour	Beam angle	CRI	lm	lm/W
P3B19S30W	30W	Non-Dim	UGR19 TP(a)	4000K	90°	>80Ra	3300	110
P3B19D30W	30W	DALI 2	UGR19 TP(a)	4000K	90°	>80Ra	3300	110
P3B19V30W	30W	1-10V	UGR19 TP(a)	4000K	90°	>80Ra	3300	110

WIRING INFORMATION

Cable / flying lead	0.75-1.5mm ²
Type of wiring required	Parallel

ACCESSORIES

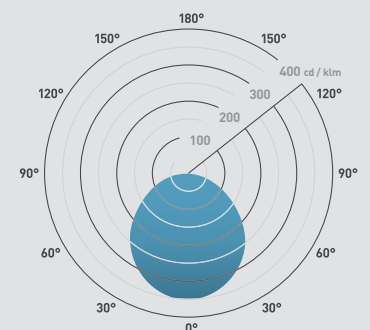

LEDEP09	3hr non-maintained emergency pack	Sold separately	315
P1SK	Suspension kit for 600 x 600 & 1200 x 300 Panels.	Sold separately	307
P2SMB	Surface mount kit for 1200 x 300 LED panel	Sold separately	307

Beam angle: 90°



Panels.

01604 495 151
collingwoodlighting.com

 @collingwoodLED
 /collingwoodlighting
 collingwoodled

GUARANTEE / WARRANTY

5 year extended warranty

FEATURES & BENEFITS

Low glare for visual comfort

Each panel is compatible with our three hour non-maintained emergency pack

Installation is quick and easy

Various sizes available

Available in both TP(a) and TP (b) to suit your preference

Suitable for reading, writing, meetings and computer-based work

Supplied with 1m long safety steel cable

Glow wire test:
P2 panels - 650°C
P3 panels - 850°C

Beam angle: 90° 110°

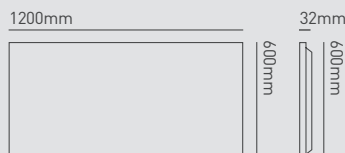
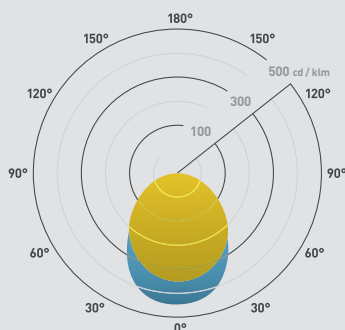

Solis 1200X600

1200 x 600 LED panel

FEATURES

Wattage	60W
IP rating	IP40
IK rating	IK06
UGR	<19 22
Sensor	No
Dimmable	DALI 2 1-10V
Input	220-240V
LED lifetime	50,000h
SDCM	6SDCM
Flicker free	Yes
Emergency version available	Yes, using CWD LEDEP09 (sold separately)

INSTALLATION INFORMATION

Install connector type	Integrated terminals
Insulation coverable	(Yes, contact us at 01604 495 151)
Inrush current	50A, 0.05ms
Construction material	PS(P2) / PC(P3) Aluminium Painted steel
Weight	UGR19: 4500g UGR22: 4300g
Maximum ambient temperature	40°
SELV	Yes
Building regulations	Part P & L
Electric class (1, 2, 3)	2

PHOTOMETRICS @ 25°C

Product code	Wattage	Dimming	UGR	Colour	Beam angle	CRI	lm	lm/W
P3C19S60W	60W	Non-Dim	UGR19 TP(a)	4000K	90°	>80Ra	6600	110
P3C19D60W	60W	DALI 2	UGR19 TP(a)	4000K	90°	>80Ra	6600	110
P3C19V60W	60W	1-10V	UGR19 TP(a)	4000K	90°	>80Ra	6600	110
P2C22S60W	60W	Non-Dim	UGR22 TP(b)	4000K	110°	>80Ra	6600	110
P2C22D60W	60W	DALI 2	UGR22 TP(b)	4000K	110°	>80Ra	6600	110
P2C22V60W	60W	1-10V	UGR22 TP(b)	4000K	110°	>80Ra	6600	110

WIRING INFORMATION

Cable / flying lead	0.75-1.5mm ²
Type of wiring required	Parallel

ACCESSORIES

LEDEP09	3hr non-maintained emergency pack	Sold separately	315
P1SKC	Suspension kit for 1200 x 600 Panels.	Sold separately	307
P2SMC	Surface mount kit for 1200 x 600 LED panel	Sold separately	307

Panels.

01604 495 151
collingwoodlighting.com

 @collingwoodLED

 /collingwoodlighting

 collingwoodled

GUARANTEE / WARRANTY

5 year extended warranty

Mounting kits are ideal solution to mount panels in places without suspended ceiling grids and where recessed mounting is not possible

Suspension kits are ideal for situations where recessed mounting is not possible

Quick and easy installation

Available to use with various sized panels



P1SK | P1SKC | P2SMA | P2SMB | P2SMC

Suspension & mounting kits for 600 x 600, 1200 x 300 & 1200 x 600 LED panels

INSTALLATION INFORMATION

Construction material	Steel / aluminium
-----------------------	-------------------

PRODUCT CODE

Product code	Description
P1SK	Suspension kit for 600 x 600 & 1200 x 300 panels
P1SKC	Suspension kit for 1200 x 600 panels
P2SMA	Surface mount kit for 600 x 600 LED panel
P2SMB	Surface mount kit for 1200 x 300 LED panel
P2SMC	Surface mount kit for 1200 x 600 LED panel

USE WITH

Solis 600X600	600 x 600 LED panel
Solis 1200X300	1200 x 300 LED panel
Solis 1200X600	1200 x 600 LED panel

Commercial downlights.

High output functional lighting

Our range of commercial downlights are suitable for countless applications such as office buildings, hospitals and hotels.

Colour switchable

Easily switch between three colour temperatures by using a conveniently located switch on the integral cable.

3000K



4000K



6500K



IP54

All of our commercial downlights have the added benefit of IP54 rating, allowing for installation near areas with water, such as bathrooms or water features.



Dimming options

As each installation is unique and has individual requirements, choose between mains, DALI or 1-10V dimming options.

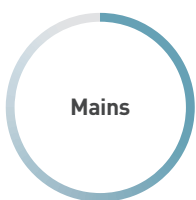

If your product has an integrated mains dimmable driver, no separate driver is required. This is classed as a 'straight to mains' product.



A DALI system can be structured in a way which allows LEDs to respond to certain rooms or zones. Each LED in the same zone will dim an equal amount.

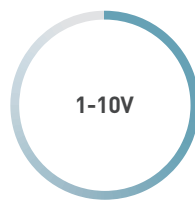

The 1-10V system allows all the LEDs which are connected to the 1-10V driver dim to an equal amount. Up to 10 power supplies can be linked to one dimmer for dimming multiple fittings.

5 year extended warranty

Across our entire commercial downlight range, we offer a five-year warranty, so you can be assured of our commitment to quality.



Emergency pack option*

In the event of a power outage, your emergency lighting system will illuminate a safe evacuation route from commercial and high occupancy buildings such as office spaces, hospitals and hotels. The Plug & play emergency pack can be used with each product in the range offering a flexible solution to complement any lighting scheme.

*For emergency pack enquires please call us on +44 (0) 1604 495 151

Choosing the ideal downlight.

For your installation

As every installation is different, it is important to choose the correct commercial downlight for the environment you are working with to ensure the best possible results.

Things to consider when choosing your commercial downlight

Follow the simple questions below to ascertain which commercial downlight is ideal for your installation. Then use the table to establish the part code of the required product.



<p>What wattage do you need?</p> <p>You will need to consider the distance between your light fittings.</p> <p>The greater the distance between products, the higher wattage product you will need to illuminate the room.</p> <p>The smaller the distance between products, the lower the wattage product you will need to illuminate the room.</p>	<p>What type of dimming do you need?</p> <p>Mains</p> <p>If your product has an integrated, mains dimmable driver, no separate driver is required. This is classed as a 'straight to mains' product.</p> <p>DALI</p> <p>A DALI system can be structured in a way which allows LEDs to respond to certain rooms or zones. Each LED in the same zone will dim an equal amount.</p> <p>1-10V</p> <p>The 1-10V system allows all the LEDs which are connected to the 1-10V driver dim to an equal amount. Up to 10 power supplies can be linked to one dimmer for dimming multiple fittings.</p>	<p>Do you need an emergency pack?</p> <p>In the event of a power outage, your emergency lighting system will illuminate a safe evacuation route from commercial and high occupancy buildings such as office spaces, hospitals and hotels.</p>	<p>Is it a retro-fit & has a hole diameter of 240-290mm?</p> <p>When retro-fitting commercial downlights, the previous downlight may have required a larger hole than is needed for our products.</p> <p>For such instances, we have a converter plate that enables you to install our commercial downlight by creating an additional surface area for the product to slot in to. Our converter plate is compatible with the 24W and 32W Thea commercial downlights.</p>  <p>Partcode: DL801MW</p>
---	--	--	--

Partcode	Wattage	Dimming	Emergency pack	Cut out (mm)
CDL0112M <small>Page 310</small>	12W	Mains	Yes	100
CDL0112D <small>Page 310</small>	12W	DALI	Yes	100
CDL0112V <small>Page 310</small>	12W	1-10V	Yes	100
CDL0116M <small>Page 311</small>	16W	Mains	Yes	150
CDL0116D <small>Page 311</small>	16W	DALI	Yes	150
CDL0116V <small>Page 311</small>	16W	1-10V	Yes	150

Partcode	Wattage	Dimming	Emergency pack	Cut out (mm)
CDL0124M <small>Page 312</small>	24W	Mains	Yes	200
CDL0124D <small>Page 312</small>	24W	DALI	Yes	200
CDL0124V <small>Page 312</small>	24W	1-10V	Yes	200
CDL0132M <small>Page 313</small>	32W	Mains	Yes	200
CDL0132D <small>Page 313</small>	32W	DALI	Yes	200
CDL0132V <small>Page 313</small>	32W	1-10V	Yes	200

Commercial downlights.

01604 495 151
collingwoodlighting.com

-  @collingwoodLED
 /collingwoodlighting
 collingwoodled

GUARANTEE / WARRANTY

5 year extended warranty

FEATURES & BENEFITS

Colour switchable for ultimate flexibility

Highly efficient

Plug & play connector on driver for easy installation to luminaire

Mains dimmable as standard



Thea 12W

Colour switchable, dimmable, plug & play commercial downlight

FEATURES

Wattage	12W
IP rating	IP54
Colour flexibility	Colour switchable
Tilttable	No
Sensor	No
Dimmable	Yes
Input	Mains AC
LED lifetime	50,000h L70 B50
SDCM	5SDCM
Emergency version available	Yes, using CWD LEDEP09 (sold separately)

INSTALLATION INFORMATION

Install connector type	Integrated terminals
Insulation coverable	No
Cut out size	100mm
Bathroom zone	2
Inrush current	1.6A 16µs
Construction material	Aluminium
Maximum ceiling thickness	20mm
Weight	316g
Maximum ambient temperature	40°C
SELV	Yes
Building regulations	P and L
Electric class (1, 2, 3)	2

PHOTOMETRICS @ 25°C

Product code	Finish	Dimming	Colour	Beam angle	CRI	lm	lm/W	lx at 1m
CDL0112M	Matt white	Mains	6500K	100°	>80Ra	1300	108	512
			4000K	100°	>80Ra	1300	108	512
			3000K	100°	>80Ra	1200	100	471
CDL0112D	Matt white	DALI	6500K	100°	>80Ra	1300	108	512
			4000K	100°	>80Ra	1300	108	512
			3000K	100°	>80Ra	1200	100	471
CDL0112V	Matt white	1-10V	6500K	100°	>80Ra	1300	108	512
			4000K	100°	>80Ra	1300	108	512
			3000K	100°	>80Ra	1200	100	471

WIRING INFORMATION

Cable / flying lead	0.5-2.5mm ²
Type of wiring required	Parallel

LED DRIVERS

Product code	Input	SELV	Dimming	Bathroom zone	Min	Max
N/A (Integrated SELV driver)	220-240V	Yes	Yes	2 (Ceiling only)	N/A	N/A

ACCESSORIES

LEDEP09	3 hour non-maintained emergency pack	Sold separately	315
---------	--------------------------------------	-----------------	-----

Beam angle: 100°

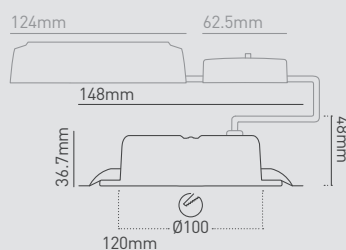
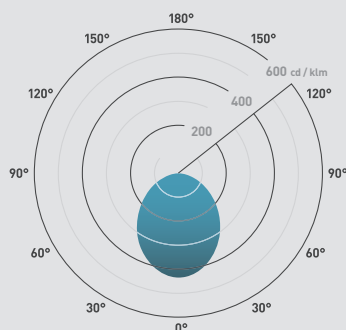

Commercial downlights.

01604 495 151
collingwoodlighting.com

 @collingwoodLED

 /collingwoodlighting

 collingwoodled

GUARANTEE / WARRANTY

5 year extended warranty

FEATURES & BENEFITS

Colour switchable for ultimate flexibility
Highly efficient
Plug & play connector on driver for easy installation to luminaire
Mains dimmable as standard



Thea 16W

Colour switchable, dimmable, plug & play commercial downlight

FEATURES

Wattage	16W
IP rating	IP54
Colour flexibility	Colour switchable
Tilttable	No
Sensor	No
Dimmable	Yes
Input	Mains AC
LED lifetime	50,000h L70 B50
SDCM	5SDCM
Emergency version available	Yes, using CWD LEDEP09 (sold separately)

INSTALLATION INFORMATION

Install connector type	Integrated terminals
Insulation coverable	No
Cut out size	150mm
Bathroom zone	2
Inrush current	1.7A 17µs
Construction material	Aluminium
Maximum ceiling thickness	20mm
Weight	484g
Maximum ambient temperature	40°C
SELV	Yes
Building regulations	P and L
Electric class [1, 2, 3]	2

PHOTOMETRICS @ 25°C

Product code	Finish	Dimming	Colour	Beam angle	CRI	lm	lm/W	lx at 1m
CDL0116M	Matt white	Mains	6500K	100°	>80Ra	1700	106	679
			4000K	100°	>80Ra	1700	106	679
			3000K	100°	>80Ra	1600	100	624
CDL0116D	Matt white	DALI	6500K	100°	>80Ra	1700	106	679
			4000K	100°	>80Ra	1700	106	679
			3000K	100°	>80Ra	1600	100	624
CDL0116V	Matt white	1-10V	6500K	100°	>80Ra	1700	106	679
			4000K	100°	>80Ra	1700	106	679
			3000K	100°	>80Ra	1600	100	624

WIRING INFORMATION

Cable / flying lead	0.5-2.5mm ²
Type of wiring required	Parallel

LED DRIVERS

Product code	Input	SELV	Dimming	Bathroom zone	Min	Max
N/A (Integrated SELV driver)	220-240V	Yes	Yes (Mains)	2 (Ceiling only)	N/A	N/A

ACCESSORIES

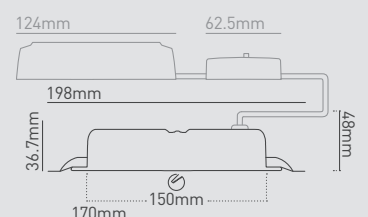
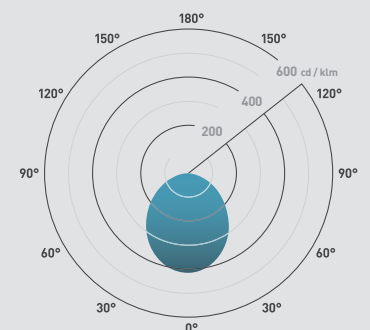

LEDEP09	3 hour non-maintained emergency pack	Sold separately	315
---------	--------------------------------------	-----------------	-----

Beam angle: 100°



Commercial downlights.

01604 495 151
collingwoodlighting.com

 @collingwoodLED
 /collingwoodlighting
 collingwoodled

GUARANTEE / WARRANTY

5 year extended warranty

FEATURES & BENEFITS

Colour switchable for ultimate flexibility

Highly efficient

Plug & play connector on driver for easy installation to luminaire

Mains dimmable as standard



Thea 24W

Colour switchable, dimmable, plug & play commercial downlight

FEATURES

Wattage	24W
IP rating	IP54
Colour flexibility	Colour switchable
Tilttable	No
Sensor	No
Dimmable	Yes
Input	Mains AC
LED lifetime	50,000h L70 B50
SDCM	5SDCM
Emergency version available	Yes, using CWD LEDEP09 (sold separately)

INSTALLATION INFORMATION

Install connector type	Integrated terminals
Insulation coverable	No
Cut out size	200mm
Bathroom zone	2
Inrush current	2.3A 9µs
Construction material	Aluminium
Maximum ceiling thickness	20mm
Weight	703g
Maximum ambient temperature	40°C
SELV	Yes
Building regulations	P and L
Electric class (1, 2, 3)	2

PHOTOMETRICS @ 25°C

Product code	Finish	Dimming	Colour	Beam angle	CRI	lm	lm/W	lx at 1m
CDL0124M	Matt white	Mains	6500K	100°	>80Ra	2800	117	1140
			4000K	100°	>80Ra	2800	117	1140
			3000K	100°	>80Ra	2600	108	1048
CDL0124D	Matt white	DALI	6500K	100°	>80Ra	2800	117	1140
			4000K	100°	>80Ra	2800	117	1140
			3000K	100°	>80Ra	2600	108	1048
CDL0124V	Matt white	1-10V	6500K	100°	>80Ra	2800	117	1140
			4000K	100°	>80Ra	2800	117	1140
			3000K	100°	>80Ra	2600	108	1048

WIRING INFORMATION

Cable / flying lead	0.5-2.5mm ²
Type of wiring required	Parallel

LED DRIVERS

Product code	Input	SELV	Dimming	Bathroom zone	Min	Max
N/A (Integrated SELV driver)	220-240V	Yes	Yes (Mains)	2 (Ceiling only)	N/A	N/A

ACCESSORIES

DL801MW	Converter plate	Sold separately	314
LEDEP09	3 hour non-maintained emergency pack	Sold separately	315

Beam angle: 100°

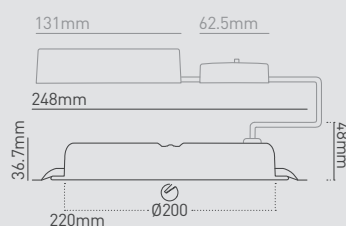
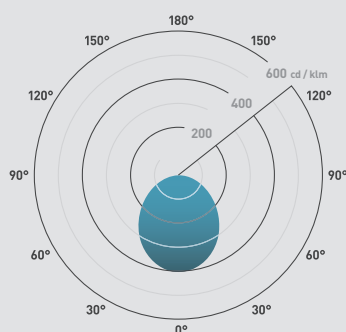



Commercial downlights.

01604 495 151
collingwoodlighting.com

@collingwoodLED

/collingwoodlighting

collingwoodled

Thea 32W

Colour switchable, dimmable, plug & play commercial downlight

FEATURES

Wattage	32W
IP rating	IP54
Colour flexibility	Colour switchable
Tilttable	No
Sensor	No
Dimmable	Yes
Input	Mains AC
LED lifetime	50,000h L70 B50
SDCM	5SDCM
Emergency version available	Yes, using CWD LEDEP09 (sold separately)

INSTALLATION INFORMATION

Install connector type	Integrated terminals
Insulation coverable	No
Cut out size	200mm
Bathroom zone	2
Inrush current	2.88A 2.4µs
Construction material	Aluminium
Maximum ceiling thickness	20mm
Weight	703g
Maximum ambient temperature	40°C
SELV	Yes
Building regulations	P and L
Electric class [1, 2, 3]	2

GUARANTEE / WARRANTY

5 year extended warranty

FEATURES & BENEFITS

- Colour switchable for ultimate flexibility
- Highly efficient
- Plug & play connector on driver for easy installation to luminaire
- Mains dimmable as standard

PHOTOMETRICS @ 25°C

Product code	Finish	Dimming	Colour	Beam angle	CRI	lm	lm/W	lx at 1m
CDL0132M	Matt white	Mains	6500K	100°	>80Ra	3500	109	1338
			4000K	100°	>80Ra	3500	109	1338
			3000K	100°	>80Ra	3400	106	1230
CDL0132D	Matt white	DALI	6500K	100°	>80Ra	3500	109	1338
			4000K	100°	>80Ra	3500	109	1338
			3000K	100°	>80Ra	3400	106	1230
CDL0132V	Matt white	1-10V	6500K	100°	>80Ra	3500	109	1338
			4000K	100°	>80Ra	3500	109	1338
			3000K	100°	>80Ra	3400	106	1230

WIRING INFORMATION

Cable / flying lead	0.5-2.5mm ²
Type of wiring required	Parallel

LED DRIVERS

Product code	Input	SELV	Dimming	Bathroom zone	Min	Max
N/A (Integrated SELV driver)	220-240V	Yes	Yes (Mains)	2 (Ceiling only)	N/A	N/A

ACCESSORIES

DL801MW	Converter plate	Sold separately	314
LEDEP09	3 hour non-maintained emergency pack	Sold separately	315

Beam angle: 100°

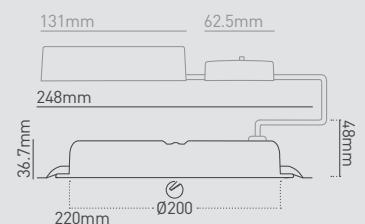
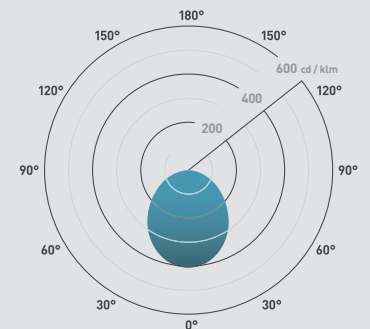

Commercial downlights.

01604 495 151
collingwoodlighting.com

 @collingwoodLED

 /collingwoodlighting

 collingwoodled

GUARANTEE / WARRANTY

1 year guarantee

FEATURES & BENEFITS

Can be used to conceal ceiling cutout that is larger than the diameter of a downlight

Ø319mm

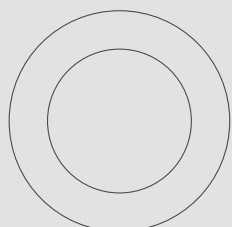

DL801MW

Hole converter plate for CDL0124/CDL0132 range

INSTALLATION INFORMATION

Cut out size	240 -290mm
Construction material	Mild steel
Maximum ceiling thickness	20mm
Weight	380g

PRODUCT CODE

Product code	Finish	Description
DL801MW	Matt White	Hole converter plates for CDL0124/CDL0132 range Ø319mm

USE WITH

THEA	Colour switchable, dimmable, plug & play commercial downlight range
------	---

Commercial downlights.

01604 495 151
collingwoodlighting.com

 @collingwoodLED

 /collingwoodlighting

 collingwoodled

GUARANTEE / WARRANTY

3 year guarantee on LED driver, 1 year
guarantee on battery

FEATURES & BENEFITS

Plug & play connector on driver for easy
installation to luminaire



LEDEP09

3-hour non-maintained emergency pack

FEATURES

Wattage	1.08W
IP rating	IP20
Input	220-240V

INSTALLATION INFORMATION

Install connector type	Flying lead
Insulation coverable	No
Construction material	Plastic
Weight	375g
Maximum ambient temperature	35°C
SELV	Yes
Electric class (1, 2, 3)	2

PRODUCT CODE

Product code	Description
LEDEP09	3hr LED maintained emergency pack

WIRING INFORMATION

Cable / flying lead	Plug & play connectors
---------------------	------------------------

USE WITH

THEA	Colour switchable, dimmable, plug & play commercial downlight
SOLIS	600 x 600, 1200 x 300, 1200 x 600 LED panels

266mm



39mm
70mm

Retail lighting.

Flexible track and recessed lighting

Choose between track and recessed lighting in a variety of finishes to obtain the ideal product for your installation. Each product is available in rotatable and tiltable lenses, providing a flexible and functional solution.

Truer, brighter colour with CrispWhite technology

Our CrispWhite technology unveils the crispest whites and most vibrant reds, allowing products to really attract the eye of customers in retail environments. The high colour rendering index (CRI >90) of this range ensures clothing and other materials look their best.

Existing fittings

Can leave merchandise looking lifeless.



Collingwood retail

Allow the true colours of merchandise to stand out with CRI >90.



Choose white

Using LUXEON CrispWhite technology, the Collingwood retail range delivers on all fronts (3000K options only.) The technology provides a unique combination of warm, saturated colours as well as creating a natural, crisp whiteness. This works by activating fluorescent agents in paints and fabrics to ultimately display merchandise in its true colours. This is ideal for CDM / CMH replacements.



Conventional retail lighting

Materials may appear washed out or 'yellowed'.



LUXEON CrispWhite Technology

Show off the true vibrant colours of materials.

Low glare accessory

To illuminate areas of heavy traffic such as paypoints or customer service desks, add this honeycomb insert to provide a diffused light.



Product families

Many retail outlets have unique layouts which do not allow for a generic install. With Collingwood Lighting's family of retail products, it is possible to include a mixture of track and recessed luminaires to accommodate the bespoke requirements of a space. Small, medium or large track luminaires can be installed in close proximity to each other to project light where needed, or to accommodate low ceilings. Our products can be retrofitted into existing track schemes and are compatible with GlobalTM 3 circuit track.

Track lighting		Round recessed		Square recessed	
Large track lighting Product: TL		Large round recessed Product: RDSL		Large square recessed Product: SQSL	
Medium track lighting Product: TM		Medium round recessed Product: RDSM		Medium square recessed Product: SQSM	
Small track lighting Product: TS		Small round recessed Product: RDSS		Small square recessed Product: SQSS	

The Collingwood Lighting retail products are available in three different sizes and finishes, making it easy to create the perfect installation.

Product comparisons

Using the diagram below, work out which sized product and output is right for your needs.

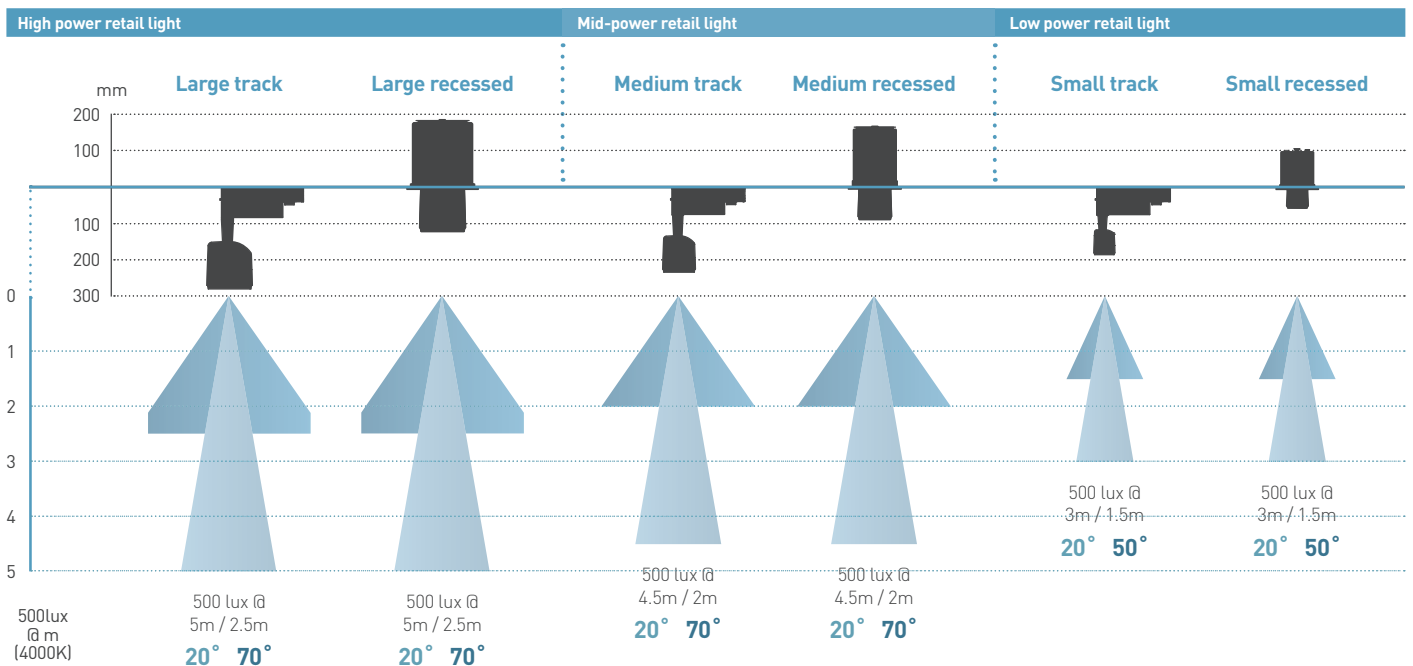

Choosing the ideal track & components.

For your installation

Using the below information, create the ideal grid for your track lighting.

Retail displays are constantly evolving. The flexible nature of track lighting ensures that merchandise will remain beautifully lit wherever displays are positioned. The lighting can be moved along a purpose-built grid with the ability to rotate and tilt, ensuring ultimate flexibility.

When building a grid, it's important to consider where the majority of your merchandise will be displayed. All of our track lighting rotates 355°, and we recommend two track set-up options as shown in diagrams A and B below.

If the majority of merchandise is displayed on walls or outside the area of your grid, you will need to assemble an **'outside'** grid.



If the majority of merchandise is displayed under the grid, you will need to assemble an **'inside'** grid.

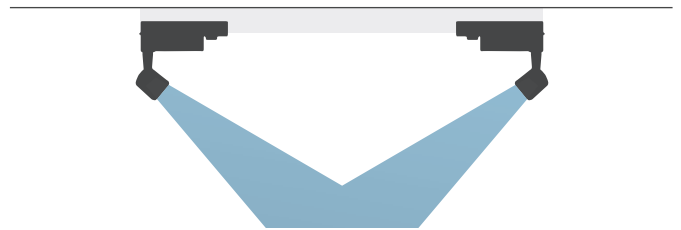

Outside grid

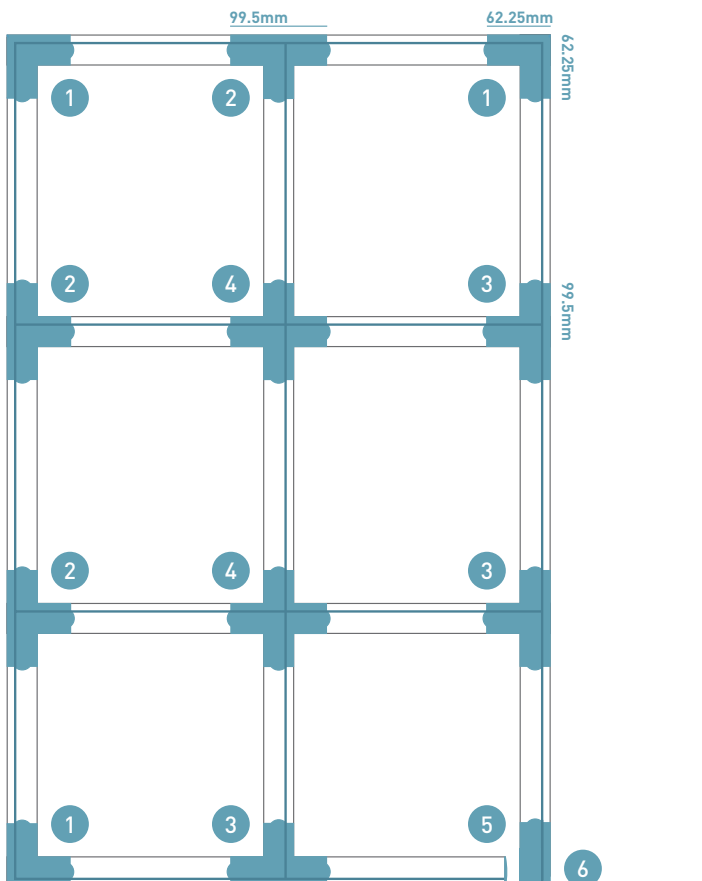

- 1 L - connector**
Use for corners.
See page 320 for partcodes.
- 2 T - connector**
Use to create a T-junction.
See page 320 for partcodes.
Use opposite T-connector mirrored.
- 3 T - connector (mirrored)**
Use to create a T-junction.
See page 320 for partcodes.
Use opposite T-connector.
- 4 X - connector**
Use to join a cross section.
See page 320 for partcodes.
- 5 End cap**
Completes the track.
See page 320 for partcodes.
- 6 Connector end feed**
Connects the grid to the mains.
See page 320 for partcodes.



Corner components

To increase the flexibility of the grid, there are three different types of connectors:

Fixed 90° corner

See page 320 for partcodes.

Flexible corner

See page 320 for partcodes.

Adjustable corner

See page 320 for partcodes.

Fixed 90°

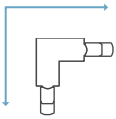

360°

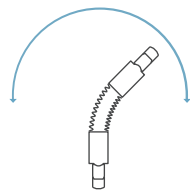

200°

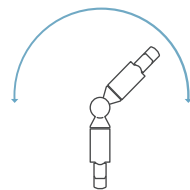

Track extensions

Track fixtures are available in 1m and 2m lengths. These can be cut shorter or increased using extensions, such as:

Straight connector

See page 320 for partcodes.

Extend sections of track using a straight connector. It sits concealed within the track, without adding extra length, for a neat and tidy finish.

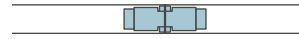

Connector middle feed

See page 320 for partcodes.

This extension adds 99.5mm length to the track. The connector middle feed allows the mains to be fed from the middle of a straight track.



Inside grid

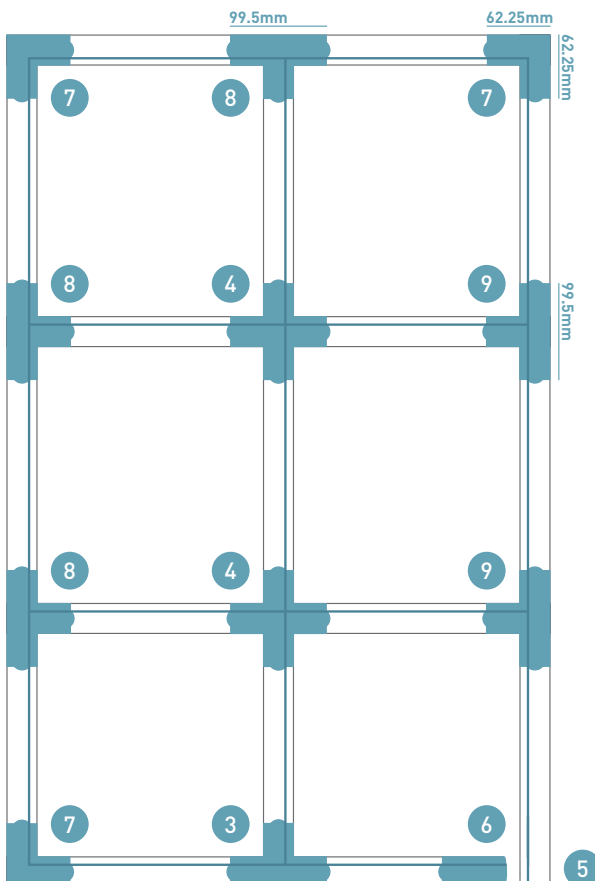

7 L - connector

Use for corners.
See page 320 for partcodes.



8 T - connector

Use to create a T-junction.
See page 320 for partcodes.

Use opposite T-connector mirrored.



9 T - connector (mirrored)

Use to create a T-junction.
See page 320 for partcodes.

Use opposite T-connector.



4 X - connector

Use to join a cross section.
See page 320 for partcodes.



5 End cap

Completes the track.
See page 320 for partcodes.



6 Connector end feed

















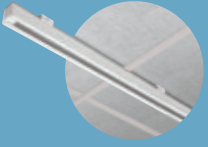

Connects the grid to the mains.
See page 320 for partcodes.

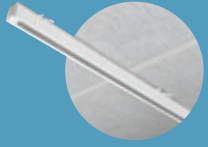

Choosing the ideal track & components.

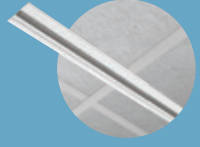
For your installation

Using the table below, determine which components you'll require for your installation.

Choose the mounting method that's relevant to your installation	Clamps required	Choice of suspension kit	Choice of track
 <p>Suspension mount To suspend track from the ceiling</p>	 <p>Suspension mount clamp Silver: SP4R1 Black: SP4R2 White: SP4R3</p>	<p>Or</p> <p>Must be used together</p>  <p>1m rod suspension Black: SPR62 White: SPR62</p>  <p>1.5m wire suspension Silver: SPW11 Black: SPW12 White: SPW13</p>  <p>Recessed ceiling clamp Silver: SKB11R1 Black: SKB11R2 White: SKB11R3</p>	<p>1m surface track Silver: XTS41001 Black: XTS41002 White: XTS41003</p>  <p>2m surface track Silver: XTS42001 Black: XTS42002 White: XTS42003</p> 
 <p>Surface mount To mount track onto a solid surface</p>	 <p>Surface mount clamp Silver: SKB121 Black: SKB122 White: SKB123</p>	<p>-</p>	<p>1m surface track Silver: XTS41001 Black: XTS41002 White: XTS41003</p>  <p>2m surface track Silver: XTS42001 Black: XTS42002 White: XTS42003</p> 
 <p>Surface mount to suspended ceiling To mount track on the surface of a suspended ceiling</p>	 <p>Suspended ceiling clamp Silver: SKB11T1 Black: SKB11T2 White: SKB11T3</p>	<p>-</p>	<p>1m surface track Silver: XTS41001 Black: XTS41002 White: XTS41003</p>  <p>2m surface track Silver: XTS42001 Black: XTS42002 White: XTS42003</p> 
 <p>Recessed mount To mount track flush to a ceiling</p>	<p>-</p>	<p>Must be used together</p>  <p>1.5m wire suspension Silver: SPW11 Black: SPW12 White: SPW13</p>  <p>Recessed ceiling clamp Silver: SKB11R1 Black: SKB11R2 White: SKB11R3</p>	<p>1m recessed track Silver: XTSF41001 Black: XTSF41002 White: XTSF41003</p>  <p>2m recessed track Silver: XTSF42001 Black: XTSF42002 White: XTSF42003</p> 

Use a bending tool to bend the internal copper cores to allow for an electrical connection.

Partcode: XTSV12



Track required

A connector end feed and an end cap are essential

Connector end feed

Silver: XTS111
Black: XTS112
White: XTS113



End cap

Silver: XTS411
Black: XTS412
White: XTS413



Connector end feed

Silver: XTS111
Black: XTS112
White: XTS113



End cap

Silver: XTS411
Black: XTS412
White: XTS413



Connector end feed

Silver: XTS111
Black: XTS112
White: XTS113



End cap

Silver: XTS411
Black: XTS412
White: XTS413



Connector end feed

Silver: XTS111
Black: XTS112
White: XTS113



End cap

Silver: XTS411
Black: XTS412
White: XTS413



Choose the appropriate connectors for your grid

Remember to consider if your grid has an 'outside' or 'inside' set up (Page 318 - 319)

Outside grid connectors



Straight connector

Silver: XTS211
Black: XTS212
White: XTS213



Connector middle feed

Silver: XTS141
Black: XTS142
White: XTS143



Flexible corner

Silver: XTS231
Black: XTS232
White: XTS233



Adjustable corner

Silver: XTS241
Black: XTS242
White: XTS243



L-connector

Silver: XTS351
Black: XTS352
White: XTS353



X-connector

Silver: XTS381
Black: XTS382
White: XTS383



T-connector

Silver: XTS391
Black: XTS392
White: XTS393



T-connector mirrored

Silver: XTS361
Black: XTS362
White: XTS363

OR

Inside grid connectors



Straight connector

Silver: XTS211
Black: XTS212
White: XTS213



Connector middle feed

Silver: XTS141
Black: XTS142
White: XTS143



Flexible corner

Silver: XTS231
Black: XTS232
White: XTS233



Adjustable corner

Silver: XTS241
Black: XTS242
White: XTS243



L-connector

Silver: XTS341
Black: XTS342
White: XTS343



X-connector

Silver: XTS381
Black: XTS382
White: XTS383



T-connector

Silver: XTS371
Black: XTS372
White: XTS373



T-connector mirrored

Silver: XTS401
Black: XTS402
White: XTS403

Cover plates

For concealing components



Feed cover plate

Silver: XTSF101
Black: XTSF102
White: XTSF103

Use with:
Connector end feed
and...
Connector middle feed



Connector cover plate

Silver: XTSF301
Black: XTSF302
White: XTSF303

Use with:
X-connector
and...
all L-connectors
and...
all T-connectors

Retail lighting.

01604 495 151
collingwoodlighting.com

 @collingwoodLED

 /collingwoodlighting

 collingwoodled

GUARANTEE / WARRANTY

7 year extended warranty

FEATURES & BENEFITS

Fully adjustable luminaire. Direct light as required

LUXEON CrispWhite technology makes white materials fluoresce (3000K only) and the >90Ra CRI makes colours bolder

Compatible with Global™ 3 circuit track

Available in white, silver and black finishes

Choice of colour temperatures and beam angles

Beam angle: 20° 70°

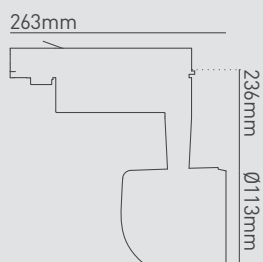
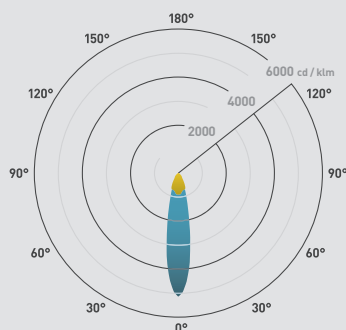

Large track

38W LED track light

FEATURES

Wattage	38W
IP rating	IP20
Colour flexibility	Fixed colour
Tiltable	90°
Rotatable	355°
Dimmable	No
Input	Mains AC
LED lifetime	70,000h L70 B50
SDCM	3SDCM

INSTALLATION INFORMATION

Cut out size	N/A
Bathroom zone	N/A
Inrush current	31A, 0.18ms
Construction material	Steel / aluminium / polycarbonate
Weight	1220g
Maximum ambient temperature	40°C
SELV	Yes
Electric class (1, 2, 3)	1

PHOTOMETRICS @ 25°C

Product code	Finish	Colour	Beam angle	CRI	lm	lm/W	lx at 1m
TLBLK2040	Black	4000K	20°	>90Ra	2800	74	12950
TLBLK7040	Black	4000K	70°	>90Ra	2800	74	2400
TLSIL2040	Silver	4000K	20°	>90Ra	2800	74	12950
TLSIL7040	Silver	4000K	70°	>90Ra	2800	74	2400
TLWH2040	White	4000K	20°	>90Ra	2800	74	12950
TLWH7040	White	4000K	70°	>90Ra	2800	74	2400
TLBLK2030	Black	3000K	20°	>90Ra	2100	55	10300
TLBLK7030	Black	3000K	70°	>90Ra	2100	55	1850
TLSIL2030	Silver	3000K	20°	>90Ra	2100	55	10300
TLSIL7030	Silver	3000K	70°	>90Ra	2100	55	1850
TLWH2030	White	3000K	20°	>90Ra	2100	55	10300
TLWH7030	White	3000K	70°	>90Ra	2100	55	1850

WIRING INFORMATION

Cable / flying lead	3 circuit track
Type of wiring required	Parallel

ACCESSORIES

TRACK ACCESSORIES	Global™ lighting track and accessories	Sold separately	320
RHCL	Glare reducing honeycomb baffle	Sold separately	325



Medium track

38W LED track light

FEATURES

Wattage	31W
IP rating	IP20
Colour flexibility	Fixed colour
Tilttable	90°
Rotatable	355°
Dimmable	No
Input	Mains AC
LED lifetime	70,000h L70 B50
SDCM	3SDCM

INSTALLATION INFORMATION

Cut out size	N/A
Bathroom zone	N/A
Inrush current	21.4A, 0.008ms
Construction material	Steel / aluminium / polycarbonate
Weight	820g
Maximum ambient temperature	40°C
SELV	Yes
Electric class (1, 2, 3)	1

PHOTOMETRICS @ 25°C

Product code	Finish	Colour	Beam angle	CRI	lm	lm/W	Lx at 1m
TMBLK2040	Black	4000K	20°	>90Ra	2000	64	10140
TMBLK7040	Black	4000K	70°	>90Ra	2000	64	2100
TMSIL2040	Silver	4000K	20°	>90Ra	2000	64	10140
TMSIL7040	Silver	4000K	70°	>90Ra	2000	64	2100
TMWH2040	White	4000K	20°	>90Ra	2000	64	10140
TMWH7040	White	4000K	70°	>90Ra	2000	64	2100
TMBLK2030	Black	3000K	20°	>90Ra	1700	55	8900
TMBLK7030	Black	3000K	70°	>90Ra	1700	55	1750
TMSIL2030	Silver	3000K	20°	>90Ra	1700	55	8900
TMSIL7030	Silver	3000K	70°	>90Ra	1700	55	1750
TMWH2030	White	3000K	20°	>90Ra	1700	55	8900
TMWH7030	White	3000K	70°	>90Ra	1700	55	1750

WIRING INFORMATION

Cable / flying lead	3 circuit track
Type of wiring required	Parallel

ACCESSORIES

TRACK ACCESSORIES	Description	Availability	Price
RHCM	Global™ lighting track and accessories	Sold separately	320
	Glare reducing honeycomb baffle	Sold separately	325

Retail lighting.

01604 495 151
collingwoodlighting.com

@collingwoodLED

/collingwoodlighting

collingwoodled

GUARANTEE / WARRANTY

7 year extended warranty

FEATURES & BENEFITS

Fully adjustable luminaire. Direct light as required

LUXEON CrispWhite technology makes white materials fluoresce (3000K only) and the >90Ra CRI makes colours bolder

Compatible with Global™ 3 circuit track

Available in white, silver and black finishes

Choice of colour temperatures and beam angles

Beam angle: 20° 70°

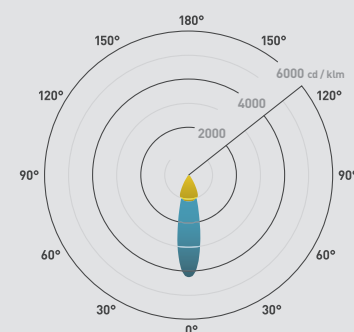

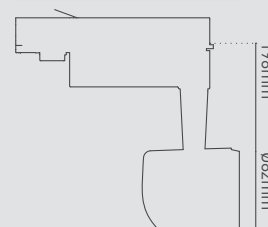

226.5mm



Retail lighting.

01604 495 151
collingwoodlighting.com

 @collingwoodLED

 /collingwoodlighting

 collingwoodled

GUARANTEE / WARRANTY

7 year extended warranty

FEATURES & BENEFITS

Fully adjustable luminaire. Direct light as required

LUXEON CrispWhite technology makes white materials fluoresce (3000K only) and the >90Ra CRI makes colours bolder

Compatible with Global™ 3 circuit track

Available in white, silver and black finishes

Choice of colour temperatures and beam angles

Beam angle: 20° 50°

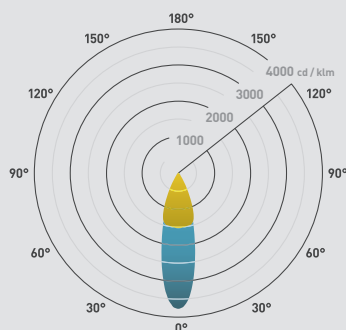

210.5mm

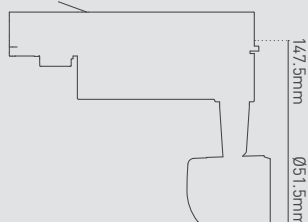

324



Small track

16W LED track light

FEATURES

Wattage	16W
IP rating	IP20
Colour flexibility	Fixed colour
Tiltable	90°
Rotatable	355°
Dimmable	No
Input	Mains AC
LED lifetime	70,000h L70 B50
SDCM	3SDCM

INSTALLATION INFORMATION

Cut out size	N/A
Bathroom zone	N/A
Inrush current	5.5A, 0.015ms
Construction material	Steel / aluminium / polycarbonate
Weight	420g
Maximum ambient temperature	40°C
SELV	Yes
Electric class (1, 2, 3)	1

PHOTOMETRICS @ 25°C

Product code	Finish	Colour	Beam angle	CRI	lm	lm/W	lx at 1m
TSBLK2040	Black	4000K	20°	>90Ra	1000	62	4140
TSBLK5040	Black	4000K	50°	>90Ra	1000	62	1650
TSSIL2040	Silver	4000K	20°	>90Ra	1000	62	4140
TSSIL5040	Silver	4000K	50°	>90Ra	1000	62	1650
TSWH2040	White	4000K	20°	>90Ra	1000	62	4140
TSWH5040	White	4000K	50°	>90Ra	1000	62	1650
TSBLK2030	Black	3000K	20°	>90Ra	750	48	3200
TSBLK5030	Black	3000K	50°	>90Ra	750	48	1300
TSSIL2030	Silver	3000K	20°	>90Ra	750	48	3200
TSSIL5030	Silver	3000K	50°	>90Ra	750	48	1300
TSWH2030	White	3000K	20°	>90Ra	750	48	3200
TSWH5030	White	3000K	50°	>90Ra	750	48	1300

WIRING INFORMATION

Cable / flying lead	3 circuit track
Type of wiring required	Parallel

ACCESSORIES

TRACK ACCESSORIES	Global™ lighting track and accessories	Sold separately	320
RHCS	Glare reducing honeycomb baffle	Sold separately	325

Retail lighting.

01604 495 151
collingwoodlighting.com

 @collingwoodLED

 /collingwoodlighting

 collingwoodled

GUARANTEE / WARRANTY

1 year extended warranty

FEATURES & BENEFITS

Add this honeycomb insert to the Collingwood retail products to provide a diffused light

To illuminate areas of heavy traffic e.g. pay points or customer service desks

RDSL | SQSL | LARGE TRACK

Beam angle: 20° 70°

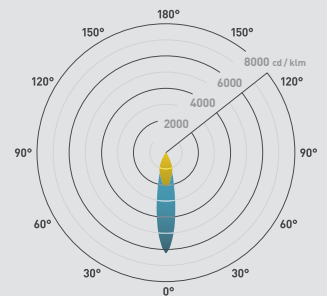

RDSM | SQSM | MEDIUM TRACK

Beam angle: 20° 70°

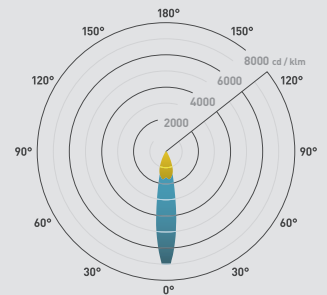

RDSS | SQSS | SMALL TRACK

Beam angle: 20° 50°

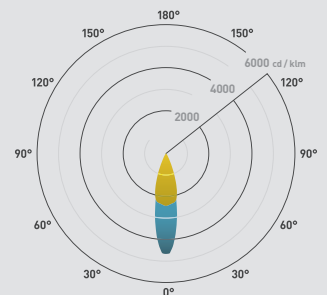

RHCL | RHCM | RHCS

Glare reducing honeycomb baffle

INSTALLATION INFORMATION

Construction material	Steel / Aluminium
Weight	RHCL 27g RHCM 16g RHCS 8g

PRODUCT CODES

Product codes	Description
RHCL (Large)	Glare reducing honeycomb baffle
RHCM (Medium)	Glare reducing honeycomb baffle
RHCS (Small)	Glare reducing honeycomb baffle

USE WITH

RHCL	RHCM	RHCS
RDSL	RDSM	RDSS
SQSL	SQSM	SQSS
LARGE TRACK	MEDIUM TRACK	SMALL TRACK

Retail lighting.

01604 495 151
collingwoodlighting.com

 @collingwoodLED

 /collingwoodlighting

 collingwoodled

GUARANTEE / WARRANTY

7 year extended warranty

FEATURES & BENEFITS

Fully adjustable luminaire. Direct light as required

LUXEON CrispWhite technology makes white materials fluoresce (3000K only) and the >90Ra CRI makes colours bolder

Choice of colour temperatures and beam angles

Ideal for retail and hospitality environments

Beam angle: 20° 70°

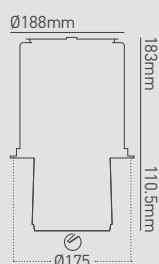
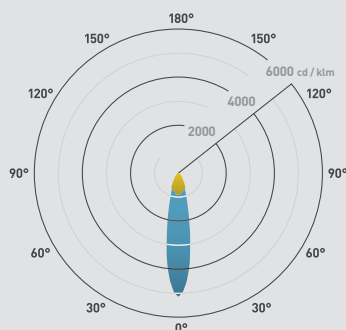

RDSL

Large, round, recessed, 32W adjustable LED downlight

FEATURES

Wattage	32W
IP rating	IP20
Colour flexibility	Fixed colour
Tiltable	90°
Rotatable	355°
Dimmable	Yes
Input	900mA
LED lifetime	70,000h L70 B50
SDCM	3SDCM

INSTALLATION INFORMATION

Cut out size	Ø 175mm
Bathroom zone	N/A
Inrush current	N/A
Construction material	Aluminium / steel
Weight	1760g
Maximum ambient temperature	40°C
SELV	N/A
Electric class (1, 2, 3)	3

PHOTOMETRICS @ 25°C

Product code	Finish	Colour	Beam angle	CRI	lm	lm/W	lx at 1m
RDSLBLK2040	Black	4000K	20°	>90Ra	2800	88 (73)	12950
RDSLBLK7040	Black	4000K	70°	>90Ra	2800	88 (73)	2400
RDSLSIL2040	Silver	4000K	20°	>90Ra	2800	88 (73)	12950
RDSLSIL7040	Silver	4000K	70°	>90Ra	2800	88 (73)	2400
RDSLWH2040	White	4000K	20°	>90Ra	2800	88 (73)	12950
RDSLWH7040	White	4000K	70°	>90Ra	2800	88 (73)	2400
RDSLBLK2030	Black	3000K	20°	>90Ra	2100	66 (55)	10300
RDSLBLK7030	Black	3000K	70°	>90Ra	2100	66 (55)	1850
RDSLSIL2030	Silver	3000K	20°	>90Ra	2100	66 (55)	10300
RDSLSIL7030	Silver	3000K	70°	>90Ra	2100	66 (55)	1850
RDSLWH2030	White	3000K	20°	>90Ra	2100	66 (55)	10300
RDSLWH7030	White	3000K	70°	>90Ra	2100	66 (55)	1850

WIRING INFORMATION

Cable / flying lead	0.30m (0.205mm ² red & black PTFE)
Type of wiring required	Series

LED DRIVERS

Product code	Input	SELV	Dimming	Bathroom zone	Min	Max
PSDIM900	220-240V	Yes	Yes (1-10V)	-	1	1
PSDAL900M	220-240V	Yes	Yes (DALI)	-	1	1

ACCESSORIES

RHCL	Glare reducing honeycomb baffle	Sold separately	325
PDC/GRID DIMMER	Grid dimmer kit for multiple fitting types	Sold separately	422



SQSL

Large, square, recessed, 32W adjustable LED downlight

FEATURES

Wattage	32W
IP rating	IP20
Colour flexibility	Fixed colour
Tilttable	90°
Rotatable	355°
Dimmable	Yes
Input	900mA
LED lifetime	70,000h L70 B50
SDCM	3SDCM

INSTALLATION INFORMATION

Cut out size	160x160mm
Bathroom zone	N/A
Inrush current	N/A
Construction material	Aluminium / steel
Weight	1920g
Maximum ambient temperature	40°C
SELV	N/A
Electric class [1, 2, 3]	3

PHOTOMETRICS @ 25°C

Product code	Finish	Colour	Beam angle	CRI	lm	lm/W	Lx at 1m
SQSLBLK2040	Black	4000K	20°	>90Ra	2800	88 (73)	12950
SQSLBLK7040	Black	4000K	70°	>90Ra	2800	88 (73)	2400
SQSLSIL2040	Silver	4000K	20°	>90Ra	2800	88 (73)	12950
SQSLSIL7040	Silver	4000K	70°	>90Ra	2800	88 (73)	2400
SQSLWH2040	White	4000K	20°	>90Ra	2800	88 (73)	12950
SQSLWH7040	White	4000K	70°	>90Ra	2800	88 (73)	2400
SQSLBLK2030	Black	3000K	20°	>90Ra	2100	66 (55)	10300
SQSLBLK7030	Black	3000K	70°	>90Ra	2100	66 (55)	1850
SQSLSIL2030	Silver	3000K	20°	>90Ra	2100	66 (55)	10300
SQSLSIL7030	Silver	3000K	70°	>90Ra	2100	66 (55)	1850
SQSLWH2030	White	3000K	20°	>90Ra	2100	66 (55)	10300
SQSLWH7030	White	3000K	70°	>90Ra	2100	66 (55)	1850

WIRING INFORMATION

Cable / flying lead	0.30m (0.205mm ² red & black PTFE)
Type of wiring required	Series

LED DRIVERS

Product code	Input	SELV	Dimming	Bathroom zone	Min	Max
PSDIM900	220-240V	Yes	Yes (1-10V)	-	1	1
PSDAL900M	220-240V	Yes	Yes (DALI)	-	1	1

ACCESSORIES

RHCL	Glare reducing honeycomb baffle	Sold separately	325
PDC/GRID DIMMER	Grid dimmer kit for multiple fitting types	Sold separately	422

Retail lighting.

01604 495 151
collingwoodlighting.com

@collingwoodLED

/collingwoodlighting

collingwoodled

GUARANTEE / WARRANTY

7 year extended warranty

FEATURES & BENEFITS

Fully adjustable luminaire. Direct light as required

LUXEON CrispWhite technology makes white materials fluoresce (3000K only) and the >90Ra CRI makes colours bolder

Choice of colour temperatures and beam angles

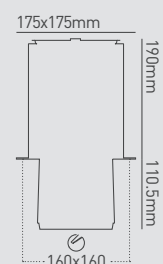
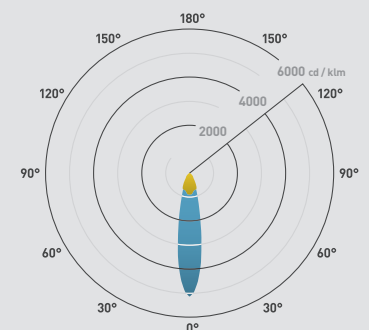

Ideal for retail and hospitality environments

Beam angle: 20° 70°



Retail lighting.

01604 495 151
collingwoodlighting.com

 @collingwoodLED
 /collingwoodlighting
 collingwoodled

GUARANTEE / WARRANTY

7 year extended warranty

FEATURES & BENEFITS

Fully adjustable luminaire. Direct light as required

LUXEON CrispWhite technology makes white materials fluoresce (3000K only) and the >90Ra CRI makes colours bolder

Choice of colour temperatures and beam angles

Ideal for retail and hospitality environments

Beam angle: 20° 70°

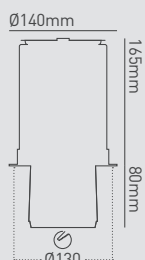
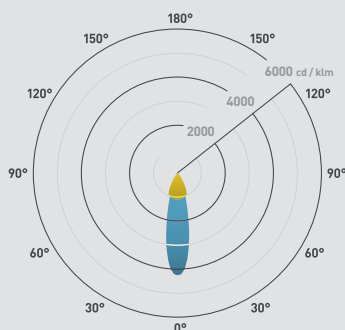

RDSM

Medium, round, recessed, 26W adjustable LED downlight

FEATURES

Wattage	26W
IP rating	IP20
Colour flexibility	Fixed colour
Tiltable	90°
Rotatable	355°
Dimmable	Yes
Input	700mA
LED lifetime	70,000h L70 B50
SDCM	3SDCM

INSTALLATION INFORMATION

Cut out size	Ø 130mm
Bathroom zone	N/A
Inrush current	N/A
Construction material	Aluminium / steel
Weight	1080g
Maximum ambient temperature	40°C
SELV	N/A
Electric class (1, 2, 3)	3

PHOTOMETRICS @ 25°C

Product code	Finish	Colour	Beam angle	CRI	lm	lm/W	lx at 1m
RDSMBLK2040	Black	4000K	20°	>90Ra	2000	77 (64)	10140
RDSMBLK7040	Black	4000K	70°	>90Ra	2000	77 (64)	2100
RDSMSIL2040	Silver	4000K	20°	>90Ra	2000	77 (64)	10140
RDSMSIL7040	Silver	4000K	70°	>90Ra	2000	77 (64)	2100
RDSMWH2040	White	4000K	20°	>90Ra	2000	77 (64)	10140
RDSMWH7040	White	4000K	70°	>90Ra	2000	77 (64)	2100
RDSMBLK2030	Black	3000K	20°	>90Ra	1700	65 (54)	8900
RDSMBLK7030	Black	3000K	70°	>90Ra	1700	65 (54)	1750
RDSMSIL2030	Silver	3000K	20°	>90Ra	1700	65 (54)	8900
RDSMSIL7030	Silver	3000K	70°	>90Ra	1700	65 (54)	1750
RDSMWH2030	White	3000K	20°	>90Ra	1700	65 (54)	8900
RDSMWH7030	White	3000K	70°	>90Ra	1700	65 (54)	1750

WIRING INFORMATION

Cable / flying lead	0.30m (0.205mm² red & black PTFE)
Type of wiring required	Series

LED DRIVERS

Product code	Input	SELV	Dimming	Bathroom zone	Min	Max
PLD UNI-DRIVE 700MA	220-240V	Yes	Yes (1-10V)	-	1	1
PSDIM700	220-240V	Yes	Yes (1-10V)	-	1	2
PSDAL700M	220-240V	Yes	Yes (DALI)	-	1	2

ACCESSORIES

RHCM	Glare reducing honeycomb baffle	Sold separately	325
PDC/GRID DIMMER	Grid dimmer kit for multiple fitting types	Sold separately	422



SQSM

Medium, square, recessed, 26W adjustable LED downlight

FEATURES

Wattage	26W
IP rating	IP20
Colour flexibility	Fixed colour
Tilttable	90°
Rotatable	355°
Dimmable	Yes
Input	700mA
LED lifetime	70,000h L70 B50
SDCM	3SDCM

INSTALLATION INFORMATION

Cut out size	125x125mm
Bathroom zone	N/A
Inrush current	N/A
Construction material	Aluminium / steel
Weight	1260g
Maximum ambient temperature	40°C
SELV	N/A
Electric class [1, 2, 3]	3

PHOTOMETRICS @ 25°C

Product code	Finish	Colour	Beam angle	CRI	lm	lm/W	Lx at 1m
SQSMBLK2040	Black	4000K	20°	>90Ra	2000	77 (64)	10140
SQSMBLK7040	Black	4000K	70°	>90Ra	2000	77 (64)	2100
SQSMSIL2040	Silver	4000K	20°	>90Ra	2000	77 (64)	10140
SQSMSIL7040	Silver	4000K	70°	>90Ra	2000	77 (64)	2100
SQSMWH2040	White	4000K	20°	>90Ra	2000	77 (64)	10140
SQSMWH7040	White	4000K	70°	>90Ra	2000	77 (64)	2100
SQSMBLK2030	Black	3000K	20°	>90Ra	1700	65 (54)	8900
SQSMBLK7030	Black	3000K	70°	>90Ra	1700	65 (54)	1750
SQSMSIL2030	Silver	3000K	20°	>90Ra	1700	65 (54)	8900
SQSMSIL7030	Silver	3000K	70°	>90Ra	1700	65 (54)	1750
SQSMWH2030	White	3000K	20°	>90Ra	1700	65 (54)	8900
SQSMWH7030	White	3000K	70°	>90Ra	1700	65 (54)	1750

WIRING INFORMATION

Cable / flying lead	0.30m (0.205mm² red & black PTFE)
Type of wiring required	Series

LED DRIVERS

Product code	Input	SELV	Dimming	Bathroom zone	Min	Max
PLD UNI-DRIVE 700MA	220-240V	Yes	Yes (1-10V)	-	1	1
PSDIM700	220-240V	Yes	Yes (1-10V)	-	1	2
PSDAL700M	220-240V	Yes	Yes (DALI)	-	1	2

ACCESSORIES

RHCM	Glare reducing honeycomb baffle	Sold separately	325
PDC/GRID DIMMER	Grid dimmer kit for multiple fitting types	Sold separately	422

Retail lighting.

01604 495 151
collingwoodlighting.com

@collingwoodLED

/collingwoodlighting

collingwoodled

GUARANTEE / WARRANTY

7 year extended warranty

FEATURES & BENEFITS

Fully adjustable luminaire. Direct light as required

LUXEON CrispWhite technology makes white materials fluoresce (3000K only) and the >90Ra CRI makes colours bolder

Choice of colour temperatures and beam angles

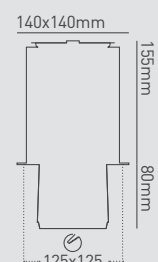
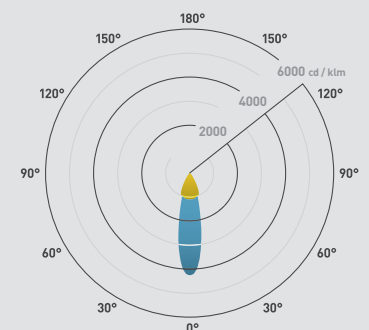

Ideal for retail and hospitality environments

Beam angle: 20° 70°



Retail lighting.

01604 495 151
collingwoodlighting.com

 @collingwoodLED
 /collingwoodlighting
 collingwoodled

GUARANTEE / WARRANTY

7 year extended warranty

FEATURES & BENEFITS

Fully adjustable luminaire. Direct light as required

LUXEON CrispWhite technology makes white materials fluoresce (3000K only) and the >90Ra CRI makes colours bolder

Choice of colour temperatures and beam angles

Ideal for retail and hospitality environments

Beam angle: 20° 50°

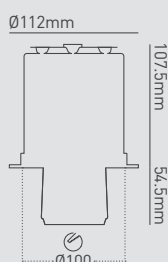
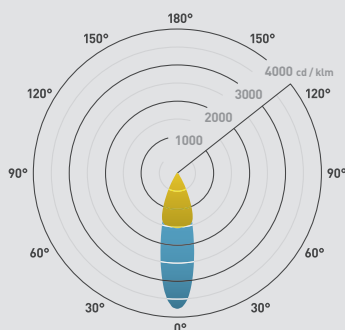

RDSS

Small, round, recessed, 13W adjustable LED downlight

FEATURES

Wattage	13W
IP rating	IP20
Colour flexibility	Fixed colour
Tilttable	90°
Rotatable	355°
Dimmable	Yes
Input	350mA
LED lifetime	70,000h L70 B50
SDCM	3SDCM

INSTALLATION INFORMATION

Cut out size	Ø 100mm
Bathroom zone	N/A
Inrush current	N/A
Construction material	Aluminium / steel
Weight	460g
Maximum ambient temperature	40°C
SELV	N/A
Electric class (1, 2, 3)	3

PHOTOMETRICS @ 25°C

Product code	Finish	Colour	Beam angle	CRI	lm	lm/W	lx at 1m
RDSSBLK2040	Black	4000K	20°	>90Ra	1000	77 (64)	4140
RDSSBLK5040	Black	4000K	50°	>90Ra	1000	77 (64)	1650
RDSSSIL2040	Silver	4000K	20°	>90Ra	1000	77 (64)	4140
RDSSSIL5040	Silver	4000K	50°	>90Ra	1000	77 (64)	1650
RDSSWH2040	White	4000K	20°	>90Ra	1000	77 (64)	4140
RDSSWH5040	White	4000K	50°	>90Ra	1000	77 (64)	1650
RDSSBLK2030	Black	3000K	20°	>90Ra	750	58 (48)	3200
RDSSBLK5030	Black	3000K	50°	>90Ra	750	58 (48)	1300
RDSSSIL2030	Silver	3000K	20°	>90Ra	750	58 (48)	3200
RDSSSIL5030	Silver	3000K	50°	>90Ra	750	58 (48)	1300
RDSSWH2030	White	3000K	20°	>90Ra	750	58 (48)	3200
RDSSWH5030	White	3000K	50°	>90Ra	750	58 (48)	1300

WIRING INFORMATION

Cable / flying lead	0.30m (0.205mm ² red & black PTFE)
Type of wiring required	Series

LED DRIVERS

Product code	Input	SELV	Dimming	Bathroom zone	Min	Max
PLD UNI-DRIVE 350MA	220-240V	Yes	Yes (1-10V)	-	1	1
PSDIM350	220-240V	Yes	Yes (1-10V)	-	1	2
PSDAL350M	220-240V	Yes	Yes (DALI)	-	1	2

ACCESSORIES

RHCS	Glare reducing honeycomb baffle	Sold separately	325
PDC/GRID DIMMER	Grid dimmer kit for multiple fitting types	Sold separately	422



SQSS

Small, square, recessed, 13W adjustable LED downlight

FEATURES

Wattage	13W
IP rating	IP20
Colour flexibility	Fixed colour
Tilttable	90°
Rotatable	355°
Dimmable	Yes
Input	350mA
LED lifetime	70,000h L70 B50
SDCM	3SDCM

INSTALLATION INFORMATION

Cut out size	90x90mm
Bathroom zone	N/A
Inrush current	N/A
Construction material	Aluminium / steel
Weight	540g
Maximum ambient temperature	40°C
SELV	N/A
Electric class [1, 2, 3]	3

PHOTOMETRICS @ 25°C

Product code	Finish	Colour	Beam angle	CRI	lm	lm/W	Lx at 1m
SQSSBLK2040	Black	4000K	20°	>90Ra	1000	77 (64)	4140
SQSSBLK5040	Black	4000K	50°	>90Ra	1000	77 (64)	1650
SQSSSIL2040	Silver	4000K	20°	>90Ra	1000	77 (64)	4140
SQSSSIL5040	Silver	4000K	50°	>90Ra	1000	77 (64)	1650
SQSSWH2040	White	4000K	20°	>90Ra	1000	77 (64)	4140
SQSSWH5040	White	4000K	50°	>90Ra	1000	77 (64)	1650
SQSSBLK2030	Black	3000K	20°	>90Ra	750	58 (48)	3200
SQSSBLK5030	Black	3000K	50°	>90Ra	750	58 (48)	1300
SQSSSIL2030	Silver	3000K	20°	>90Ra	750	58 (48)	3200
SQSSSIL5030	Silver	3000K	50°	>90Ra	750	58 (48)	1300
SQSSWH2030	White	3000K	20°	>90Ra	750	58 (48)	3200
SQSSWH5030	White	3000K	50°	>90Ra	750	58 (48)	1300

WIRING INFORMATION

Cable / flying lead	0.30m (0.205mm ² red & black PTFE)
Type of wiring required	Series

LED DRIVERS

Product code	Input	SELV	Dimming	Bathroom zone	Min	Max
PLD UNI-DRIVE 350MA	220-240V	Yes	Yes (1-10V)	-	1	1
PSDIM350	220-240V	Yes	Yes (1-10V)	-	1	2
PSDAL350M	220-240V	Yes	Yes (DALI)	-	1	2

ACCESSORIES

RHCS	Glare reducing honeycomb baffle	Sold separately	325
PDC/GRID DIMMER	Grid dimmer kit for multiple fitting types	Sold separately	422

Retail lighting.

01604 495 151
collingwoodlighting.com

- @collingwoodLED
- /collingwoodlighting
- collingwoodled

GUARANTEE / WARRANTY

7 year extended warranty

FEATURES & BENEFITS

Fully adjustable luminaire. Direct light as required

LUXEON CrispWhite technology makes white materials fluoresce (3000K only) and the >90Ra CRI makes colours bolder

Choice of colour temperatures and beam angles

Ideal for retail and hospitality environments

Beam angle: 20° 50°

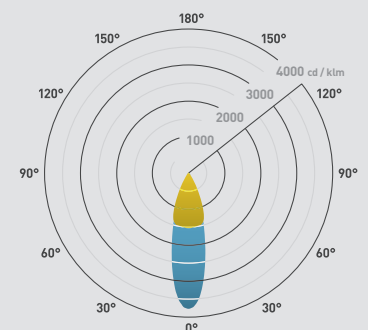

100x100mm

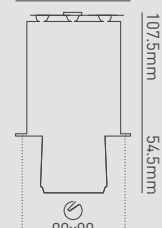

Bulkheads.

Bulkhead lighting is a functional, and simple light that offers a solution to the requirement of lighting indoor communal spaces such as corridors and stairways. They can be used in residential, commercial or industrial settings and can be attached to walls and ceilings. In addition to indoor use, this IP65 rated product is also ideal for use outdoors, whether it is for lighting pathways, car parks or highly-trafficked public areas.

Adding extra efficiency and security, our bulkheads can be purchased with microwave sensors which activate when motion is detected, ensuring appropriate illumination and conserving energy by only lighting when required. This dynamic product is also available in Collingwood's emergency pack service, wherein the lights have already been pre-wired, providing a flexible solution and peace of mind, ultimately reducing installation time.

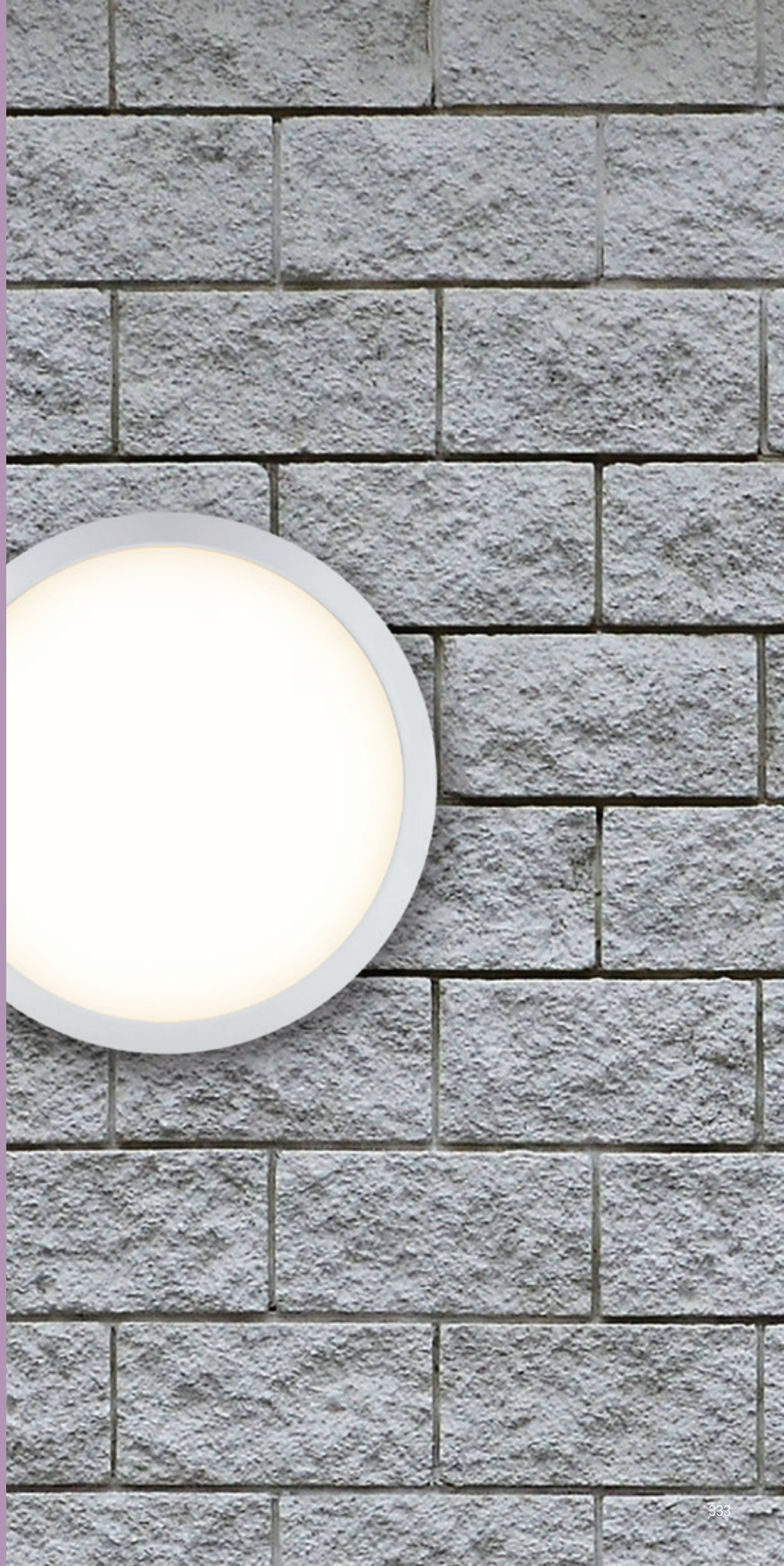

Bulkheads.

Functional illumination

Ideal for exteriors and illuminating large outdoor spaces. This versatile product is also suitable for internal stairwells and where there is a requirement for well lit spaces by a high output luminaire.

Microwave sensors

Microwave sensor versions of our WL92 bulkhead create spaces that are energy efficient as the light will only activate when sensing motion nearby. This option is perfect for areas with high footfall, such as public spaces, communal corridors and staircases.

How does it work

Microwave sensors send out pulses which bounce off nearby objects and measure the reflections.

When a moving object enters the area, the sensor receives a new reflection which trips the sensor and activates the light.

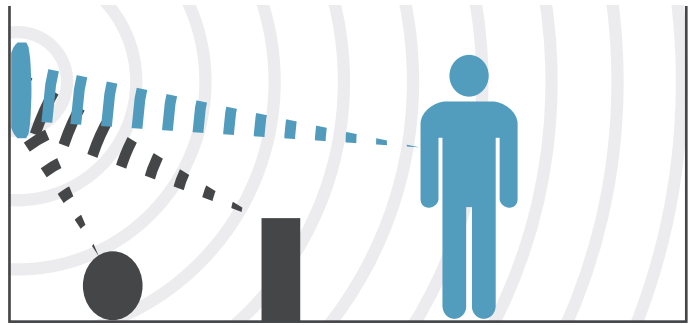
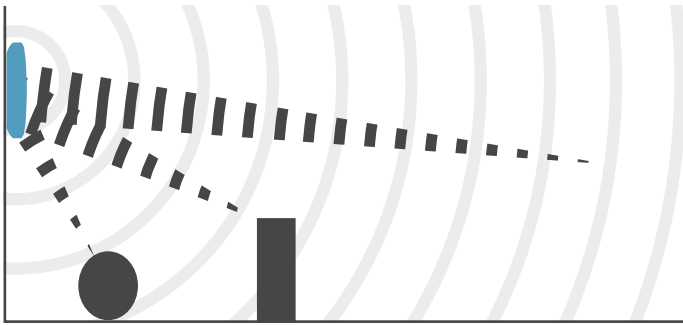

Colour switchable

Easily switch between three colour temperatures by using a switch on the inside of the product.

3000K



4000K



6500K



Easy mounting options

Our bulkheads offer the versatility of different mounting options, allowing for easier install and ensuring that the product is versatile enough to install in most environments.

Two-point cable entry

Cable can run through one of two potential entry points: top and bottom, or side to side, depending on orientation of the fitting.



Rear cable entry

The cable can exit through the back of the product, concealing it and ensuring maximum aesthetic appeal.



BESA box mountable

Our bulkheads have points for screws to pass through, allowing it to easily attach to a BESA box.



Emergency pack service

In the event of a power outage, your emergency lighting system will illuminate a safe evacuation route. Ideal for commercial and high occupancy buildings such as office spaces, hospitals and hotels.

Collingwood Lighting's pre-wired emergency pack service option is available across our bulkhead range offering a flexible solution to compliment any lighting scheme. With this service, the wiring has already been completed so you don't have to, providing peace of mind and reducing installation time.

Waterproof

All of our bulkheads are IP65 rated, meaning they are perfect for outdoor use.

Choosing the ideal bulkhead.

For your installation

As every installation is different, it is important to choose the correct bulkhead for the environment you are working with to ensure the best possible results.

Things to consider when choosing your bulkhead

Follow the simple questions below to ascertain which bulkhead is ideal for your installation. Then use the table to establish the part code of the required product.

What output do you need for your bulkhead?

Use the table below to determine the lumen output you will require for your space, using the wattage of the bulkhead.

Wattage	Lumens
12W (12.5W)*	1350lm
19W (19.5W)*	2050lm

*Microwave

Do you need a microwave sensor?

Microwave sensor versions of our bulkhead create spaces that are energy efficient as the light only activates when sensing movement nearby. This option is perfect for highly trafficked public spaces such as communal corridors and stairwells.

Microwave sensor activated bulkheads also improve security by lighting up areas whenever movement is detected. This means that this product is perfect for outdoor spaces such as car parks and bin yards.

Do you need an emergency pack?

In the event of a power outage, your emergency lighting system will illuminate a safe evacuation route from commercial and high occupancy buildings such as office spaces, hospitals and hotels.

The emergency pack option comes pre-wired across our bulkhead range offering a flexible solution to compliment any lighting scheme. With this service, the wiring has already been completed so you don't have to, providing piece of mind and reducing installation time.

Do you need a bezel for your bulkhead?

Black ring

Ring bezel partcode: WL92BR
Page 338



Black eyelid

Eyelid bezel partcode: WL92BE
Page 338



Black grille

Grille bezel partcode: WL92BG
Page 338



Partcode	Wattage	Microwave sensor	Emergency pack
WL9212SCS Page 336	12W	No	No
WL9212MCS Page 336	12.5W	Yes	No
WL9212WCS Page 336	12W	No	Yes
WL9212CCS Page 336	12.5W	Yes	Yes

Partcode	Wattage	Microwave sensor	Emergency pack
WL9219SCS Page 337	19W	No	No
WL9219MCS Page 337	19.5W	Yes	No
WL9219ECS Page 337	19W	No	Yes
WL9219CCS Page 337	19.5W	Yes	Yes

Bulkheads.

01604 495 151
collingwoodlighting.com

- @collingwoodLED
- /collingwoodlighting
- collingwoodled

GUARANTEE / WARRANTY

3 year extended warranty

FEATURES & BENEFITS

- Colour switchable
- Two lumen levels
- Lid accessories available: Eyelid, Grille and Black trim

Beam angle: 100°

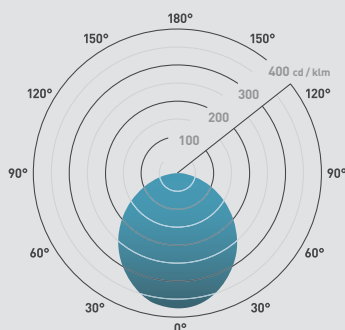

Ø300mm 81mm

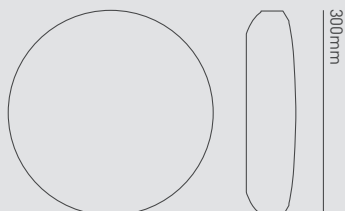

WL92 12W

Straight to mains, 12W general purpose LED bulkhead

FEATURES

Wattage	12 - 12.5W
IP rating	IP65
IK rating	IK10
Colour flexibility	Colour switchable
Dimmable	No
Input	Mains AC
LED lifetime	25,000h L70 B50
Sensor	Microwave
Emergency version available	Yes

INSTALLATION INFORMATION

Bathroom zone	2
Inrush current	4.6A 0.00098ms
Construction material	PC Plastic
Weight	900g
Maximum ambient temperature	40°C
Electric class (1, 2, 3)	2

PHOTOMETRICS @ 25°C

Product code	Sensor	Emergency	Wattage	Colour	Beam angle	CRI	lm	lm/W	lx at 1m
WL9212SCS	Non microwave sensor	Non emergency option	12W	6500K	100°	>80Ra	1350	113	523
				4000K	100°	>80Ra	1350	113	523
				3000K	100°	>80Ra	1350	113	523
WL9212MCS	Microwave sensor	Non emergency option	12.5W	6500K	100°	>80Ra	1350	108	525
				4000K	100°	>80Ra	1350	108	525
				3000K	100°	>80Ra	1350	108	525
WL9212ECS	Non microwave sensor	Emergency option	12W	6500K	100°	>80Ra	1350	113	525
				4000K	100°	>80Ra	1350	113	525
				3000K	100°	>80Ra	1350	113	525
WL9212CCS	Microwave sensor	Emergency option	12.5W	6500K	100°	>80Ra	1350	108	525
				4000K	100°	>80Ra	1350	108	525
				3000K	100°	>80Ra	1350	108	525

WIRING INFORMATION

Cable / flying lead	Push-fit terminals 1.5mm ² max.
Type of wiring required	Parallel

ACCESSORIES

WL92BR	Black Ring Accessory	Sold separately	338
WL92BE	Black Eyelid Accessory	Sold separately	338
WL92BG	Black Grille Accessory	Sold separately	338



Bulkheads.

01604 495 151
collingwoodlighting.com

@collingwoodLED

/collingwoodlighting

collingwoodled

WL92 19W

Straight to mains, 19W general purpose LED bulkhead

FEATURES

Wattage	19 - 19.5W
IP rating	IP65
IK rating	IK10
Colour flexibility	Colour switchable
Dimmable	No
Input	Mains AC
LED lifetime	25,000h L70 B50
Sensor	Microwave
Emergency version available	Yes

INSTALLATION INFORMATION

Bathroom zone	2
Inrush current	4.3A 0.00084ms
Construction material	PC Plastic
Weight	900g
Maximum ambient temperature	40°C
Electric class (1, 2, 3)	2

GUARANTEE / WARRANTY

3 year extended warranty

FEATURES & BENEFITS

Colour switchable

Two lumen levels

Lid accessories available: Eyelid, Grille and Black trim

PHOTOMETRICS @ 25°C

Product code	Sensor	Emergency	Wattage	Colour	Beam angle	CRI	lm	lm/W	lx at 1m
WL9219SCS	Non microwave sensor	Non emergency option	19W	6500K	100°	>80Ra	2050	108	825
				4000K	100°	>80Ra	2050	108	825
				3000K	100°	>80Ra	2050	108	825
WL9219MCS	Microwave sensor	Non emergency option	19.5W	6500K	100°	>80Ra	2050	105	825
				4000K	100°	>80Ra	2050	105	825
				3000K	100°	>80Ra	2050	105	825
WL9219ECS	Non microwave sensor	Emergency option	19W	6500K	100°	>80Ra	2050	108	825
				4000K	100°	>80Ra	2050	108	825
				3000K	100°	>80Ra	2050	108	825
WL9219CCS	Microwave sensor	Emergency option	19.5W	6500K	100°	>80Ra	2050	105	825
				4000K	100°	>80Ra	2050	105	825
				3000K	100°	>80Ra	2050	105	825

WIRING INFORMATION

Cable / flying lead	Push-fit terminals 1.5mm ² max.
Type of wiring required	Parallel

ACCESSORIES

WL92BR	Black Ring Accessory	Sold separately	338
WL92BE	Black Eyelid Accessory	Sold separately	338
WL92BG	Black Grille Accessory	Sold separately	338

Beam angle: 100°

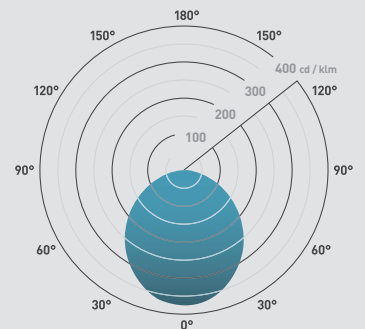

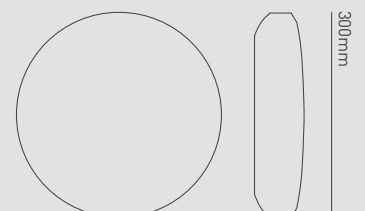

Ø300mm

81mm



Bulkheads.

01604 495 151
collingwoodlighting.com

-  @collingwoodLED
-  /collingwoodlighting
-  collingwoodled

GUARANTEE / WARRANTY

3 year extended warranty

FEATURES & BENEFITS

- Suitable for all the Bulkheads
- Aesthetically appealing
- Tamper proof screw

Ø300mm

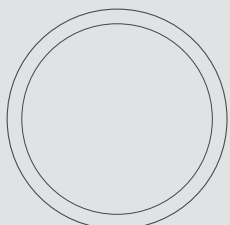

WL92 Bezels

Fascia options for the bulkhead range

INSTALLATION INFORMATION

Construction material	PMMA Plastic
-----------------------	--------------

PRODUCT CODE

Product code	Description
WL92BR	Black Ring Accessory
WL92BE	Black Eyelid Accessory
WL92BG	Black Grille Accessory

USE WITH

WL92	Straight to mains, 12W or 19W general purpose LED bulkhead
------	--



Industrial.

Collingwood has entered Industrial lighting. The range consists of high bays, low bays and industrial floodlights available for specification and installation. Our expertise in LED technology has been applied to this sector to provide a class leading solution. Market leading efficacies, combined with a five year extended warranty, provides low lifetime running cost across products which are built to last.

The industrial range is designed to make installation simple. New, innovative materials reduce the weight of the products to ease the process of mounting and commissioning. Magnesium alloy makes the high bays an average 36% lighter than aluminium equivalents, which makes a positive impact to those installing the products. Collingwood's industrial lighting is full of features and benefits, all of which are explained within the following section.



Industrial lighting.

For a wide variety of industrial settings

We are proud to be able to offer a comprehensive range of industrial lighting. Our expertise in LED lighting has been applied to this market sector so that Collingwood quality is now available for installation.

The industrial range

The range of high bays, low bays, industrial floodlights and anti-corrosives has been developed to far exceed the standard requirements for warehouses, factories and workshop installations. Market leading efficacies reduce running costs across the long warranty periods, ensuring that there is peace of mind to prove that the range is built to last.

Springbok high bays

These IP65 high bays are manufactured from magnesium alloy, which makes them, on average 36% lighter than aluminium equivalents. The light weight makes them simple to install and also offers excellent heat dissipation. The Springbok's have a five year extended warranty available, supported by a 50,000 hour LED lifetime, at an ambient temperature range of -40°C to +50°C.



Lentus low bays

The IP40 lentus low bays have a linear design, which makes them ideal for lighting aisle spaces. Their beam angle is 120° as standard but there are two types of lens accessories available, depending on the installation requirement, 90° or an asymmetric 50°x90°. The lenses can be replaced after installation if the aisle configuration changes over time, without the need to take the fitting down.



K2 floodlights

The IP65 K2 floodlights are the perfect solution for warehouses, loading bays, or car parks. The design of the K2 has been tailored so that installation is simple. There is 1m of flex supplied as standard and the brackets have mounting angles stamped into them, to ensure that the fitting is mounted consistently each and every time. The star washers ensure that the fitting is held in place, in the long term.



Caiman anti-corrosives

The Caiman anti-corrosive is built to withstand the toughest of industrial environments, being IP65 and IK08 makes it resistant to water, dust and high impact. Its robust polycarbonate exterior makes it an ideal choice for both indoor and outdoor car parks, supplied as standard with pre-fitted, tamper resistant clips further protecting it from its surroundings.



Payback

The industrial range can produce up to 150lm/W, which offers low lifetime running cost, especially compared against non-LED equivalents.

The table below shows an example of the cost savings which can be achieved through installing our 150W high bay over a 400W non LED equivalent.

Energy rate £/kWh: £0.15	Existing fitting	Our fitting
Average lamp life	12,000 hours	50,000 hours
Quantity of fittings	100	100
Watts per fitting	400W	150W
Energy £/Year	£26,928	£9,180

Microwave sensors

Save energy and money

Collingwood’s high bay and low bay sensor maximises energy savings by encompassing the most advanced technology in movement detection, and daylight harvesting in one single, fully programmable unit.

Step dimming

The sensor detects movement from up to 15 meters high and allows the user to set up two step-dim parameters, offering full control of the luminaire light output and the time it is on.

Daylight harvesting

Whilst the sensor is detecting movement, the daylight harvesting feature controls the luminaire light output, adjusting the 1-10V signal accordingly with the natural light, provided by skylights and windows, maintaining a programmable pre-set illuminance level on the work surface, and reducing tremendously the energy consumption.

Timer control

The same lumen output is kept during the programmable hold time, since the last movement was detected. After that, the sensor dims the luminaire to an intermediary lumens output stand-by time, for a period selected by the user. After this period, the sensor can switch off the luminaire.

Remote control

All functions are programmable by a user friendly remote controller and one single controller can set the functions of multiple different sensors.



Springbok.

High bays

Our Springbok high bays combine excellent performance with quick payback.

New technology

LED technology and modern electronics drives down the lifetime running cost of the fittings. 140lm/W maximises the usage of electricity and light output to achieve an effective lit environment whilst minimising costs.

Cost savings also arise from the 50,000 LED lifetime at L70B10, reinforced by a five year extended warranty. The long lifetime of the fittings results in fewer replacements over time, reducing both the cost of buying and installing new fittings.

The table below shows an example of the costs savings which can be achieved:

Energy rate £/kWh: £0.15	Existing fitting	Our fitting
Average lamp life	12,000 hours	50,000 hours
Quantity of fittings	100	100
Watts per fitting	400W	150W
Energy £/Year	£26,928	£9,180

Magnesium alloy

Lightweight

The Springbok high bay is made from the lightest metal element, magnesium alloy, which makes it 36% lighter than aluminium equivalents.

Heat dissipation

The magnesium alloy design provides perfect heat dissipation for thermal management which works from -40°C to +50°C.

Corrosion resistant

It is corrosion resistant, making it suitable for coastal environments.



Choosing the ideal high bay and accessories

High bays are selected on a multitude of factors, which range from the purpose of the environment which they are being installed into, the mounting height and beyond. Our three high bays have outputs from 14,000lm to 28,000lm, which can all be used alongside our reflectors and refractor accessories.

Use the graph below to choose your ideal high bay, or for a consultation on your requirements, contact our expert team today. The designers inside The Studio at Collingwood are able to offer expertise throughout the lighting design process, putting together full schemes based around our comprehensive product range. Detailed client consultation ensures a high quality and tailored service.

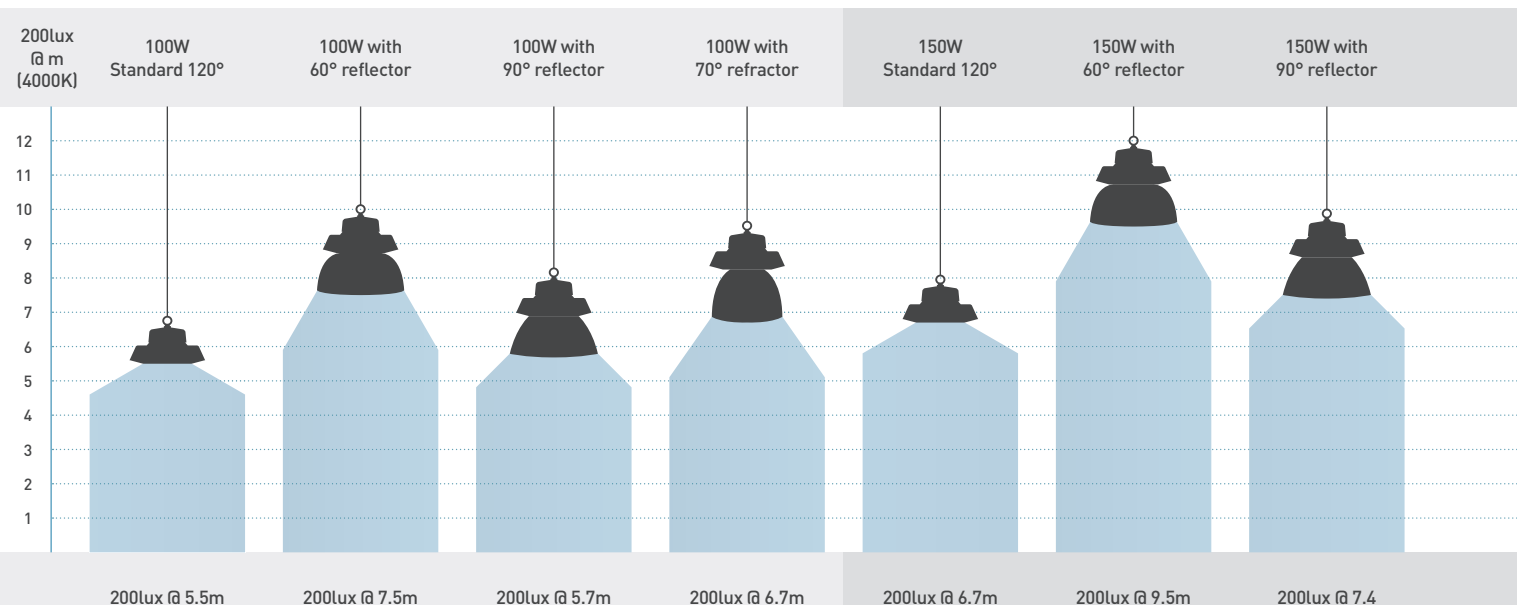

Mounting options

The Springbok high bay is supplied with an M10 SS304 eyelet, meaning they can be surface mounted on a pot hook, or on a chain allowing for flexible mounting heights. They can also be pole mounted for a rigid install.

Surface mount

The Springbok can be surface mounted by fixing the hook directly to the substrate.

Flexible heights

The Springbok can be mounted at virtually any height by using an adequate chain.

Rigid install

Alternatively, the Springbok can be fixed by means of a U-bracket, allowing wall and pole mounting installations.



Flicker free

In line with Collingwood values, the best electrical components have been included in the product design. This has resulted in our confidence to assert that the high bays are flicker free fittings.

Having flicker free high bays results in a more comfortable working environment and increases employee satisfaction and productivity.



Microwave-sensor

Save energy and money

The high bay sensor accessory maximises energy savings in one single, fully programmable unit.

Step dimming

The sensor detects movement and allows the user to set up two step-dim parameter.

Daylight harvesting

The daylight harvesting feature controls the luminaire light output, adjusting the signal accordingly with the natural light.

Timer control

Stand-by times can be set by the user.

Remote control

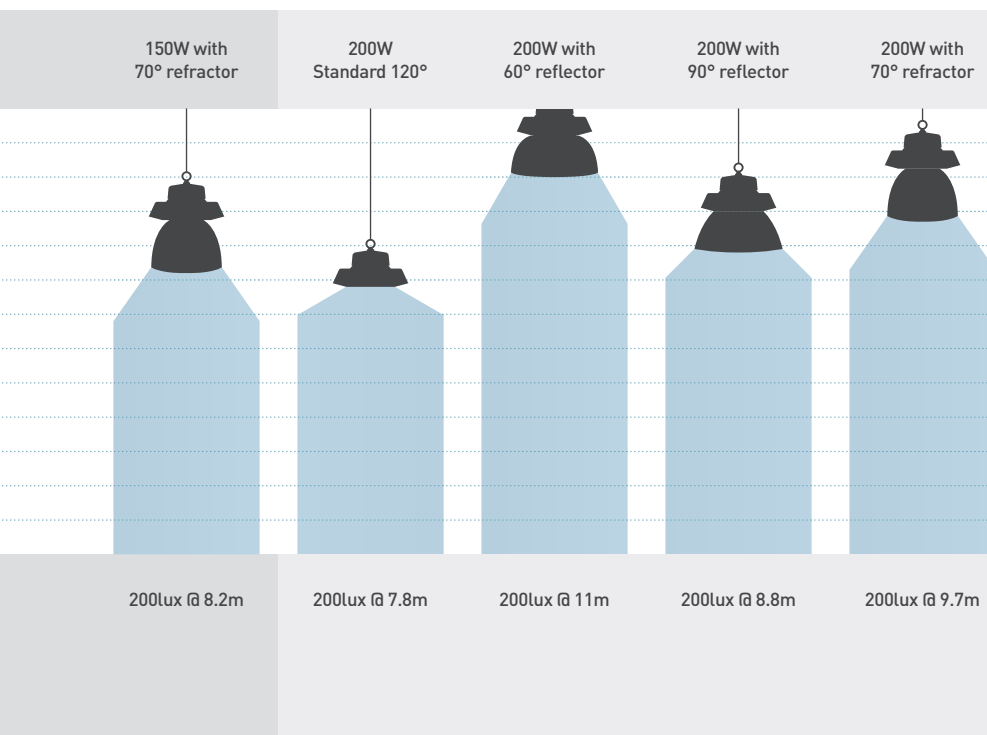

All functions are programmable by a user friendly remote controller.

For more information, see page 341.



High bays.

01604 495 151
collingwoodlighting.com

 @collingwoodLED
 /collingwoodlighting
 collingwoodled

GUARANTEE / WARRANTY

5 year extended guarantee

FEATURES & BENEFITS

Black magnesium alloy design for excellent heat dissipation

Robust and can withstand tough environments

A range of accessories available

Highly efficient 140lm/W

1-10V

Surge protection 4KV



Springbok 200W

High bay, highly efficient 140lm/W, 1-10V dimmable as standard

FEATURES

Wattage	200W
IP rating	IP65
IK rating	IK08
Dimmable	1-10V, PWM & Resistor
Input	100-277 V~ Surge protection 4KV
LED lifetime	50,000h L70 B10
SDCM	5SDCM
Flicker Free	Yes
Emergency version available	No

INSTALLATION INFORMATION

Install connector type	Flying lead
Inrush current	45A 0.6ms
Construction material	Magnesium Alloy Tempered Glass Eyelet SS304
Weight	4.20Kg
Maximum ambient temperature	-40°C to +50°C
Building regulations	Part P
Electric class (1, 2, 3)	1

PHOTOMETRICS @ 25°C

Product code	Finish	Wattage	Colour	Beam angle	CRI	lm	lm/W	lx at 1m
HB20040	Black	200W	4000K	120°	80Ra	28000	140	9909

WIRING INFORMATION

Cable / flying lead	2000mm H05RN-F 3x1.0mm ² Ø7mm
Type of wiring required	Parallel

ACCESSORIES

HBA60	Reflector 60° - Aluminium, natural finishing	Sold separately	349
HBA90	Reflector 90° - Aluminium, natural finishing	Sold separately	349
HBA70	Reflector 70° - Polycarbonate, translucent	Sold separately	349
HBAS	Microwave sensor	Sold separately	349
HBASDHS	Microwave & Daylight harvesting sensor	Sold separately	349
HBASDHSRC	Microwave & Daylight harvesting sensor controller	Sold separately	349

Beam angle: 120°

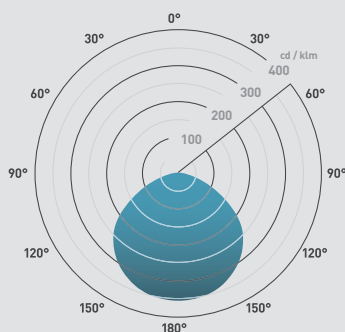

Ø300mm

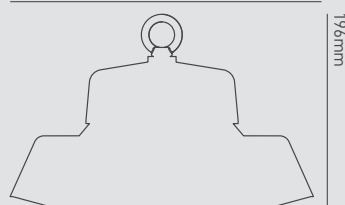



High bays.

01604 495 151
collingwoodlighting.com

@collingwoodLED

/collingwoodlighting

collingwoodled

Springbok 150W

High bay, highly efficient 140lm/W, 1-10V dimmable as standard

FEATURES

Wattage	150W
IP rating	IP65
IK rating	IK08
Dimmable	1-10V, PWM & Resistor
Input	100-277 V~ Surge protection 4KV
LED lifetime	50,000h L70 B10
SDCM	5SDCM
Flicker Free	Yes
Emergency version available	No

INSTALLATION INFORMATION

Install connector type	Flying lead
Inrush current	45A 0.6ms
Construction material	Magnesium Alloy Tempered Glass Eyelet SS304
Weight	3.70Kg
Maximum ambient temperature	-40°C to +50°C
Building regulations	Part P
Electric class [1, 2, 3]	1

GUARANTEE / WARRANTY

5 year extended guarantee

FEATURES & BENEFITS

Black magnesium alloy design for excellent heat dissipation

Robust and can withstand tough environments

A range of accessories available

Highly efficient 140lm/W

1-10V

Surge protection 4KV

PHOTOMETRICS @ 25°C

Product code	Finish	Wattage	Colour	Beam angle	CRI	lm	lm/W	Lx at 1m
HB15040	Black	150W	4000K	120°	80Ra	21000	140	7545

WIRING INFORMATION

Cable / flying lead	2000mm H05RN-F 3x1.0mm ² Ø7mm
Type of wiring required	Parallel

ACCESSORIES

HBA60	Reflector 60° - Aluminium, natural finishing	Sold separately	349
HBA90	Reflector 90° - Aluminium, natural finishing	Sold separately	349
HBA70	Refractor 70° - Polycarbonate, translucent	Sold separately	349
HBAS	Microwave sensor	Sold separately	349
HBASDHS	Microwave & Daylight harvesting sensor	Sold separately	349
HBASDHSRC	Microwave & Daylight harvesting sensor controller	Sold separately	349

Beam angle: 120°

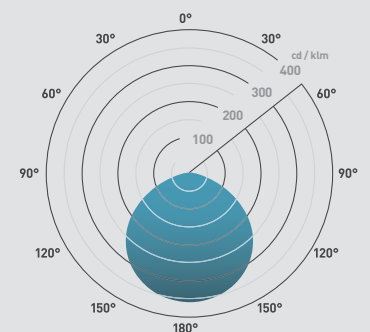

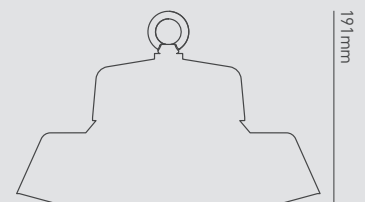

Ø280mm



High bays.

01604 495 151
collingwoodlighting.com

-  @collingwoodLED
 /collingwoodlighting
 collingwoodled

GUARANTEE / WARRANTY

5 year extended guarantee

FEATURES & BENEFITS

Black magnesium alloy design for excellent heat dissipation

Robust and can withstand tough environments

A range of accessories available

Highly efficient 140lm/W

1-10V

Surge protection 4KV



Springbok 100W

High bay, highly efficient 140lm/W, 1-10V dimmable as standard

FEATURES

Wattage	100W
IP rating	IP65
IK rating	IK08
Dimmable	1-10V, PWM & Resistor
Input	100-277 V~ Surge protection 4KV
LED lifetime	50,000h L70 B10
SDCM	5SDCM
Flicker Free	Yes
Emergency version available	No

INSTALLATION INFORMATION

Install connector type	Flying lead
Inrush current	45A 0.6ms
Construction material	Magnesium Alloy Tempered Glass Eyelet SS304
Weight	2.70Kg
Maximum ambient temperature	-40°C to +50°C
Building regulations	Part P
Electric class (1, 2, 3)	1

PHOTOMETRICS @ 25°C

Product code	Finish	Wattage	Colour	Beam angle	CRI	lm	lm/W	lx at 1m
HB10040	Black	100W	4000K	120°	80Ra	14000	140	5030

WIRING INFORMATION

Cable / flying lead	2000mm H05RN-F 3x1.0mm ² Ø7mm
Type of wiring required	Parallel

ACCESSORIES

HBA60	Reflector 60° - Aluminium, natural finishing	Sold separately	349
HBA90	Reflector 90° - Aluminium, natural finishing	Sold separately	349
HBA70	Reflector 70° - Polycarbonate, translucent	Sold separately	349
HBAS	Microwave sensor	Sold separately	349
HBASDHS	Microwave & Daylight harvesting sensor	Sold separately	349
HBASDHSRC	Microwave & Daylight harvesting sensor controller	Sold separately	349

Beam angle: 120°

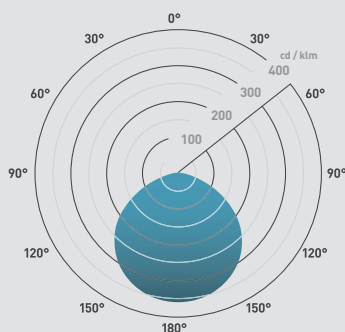

Ø245mm

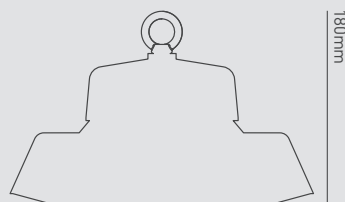



HBA90

Accessory for a intensive beam of light

FEATURES

Product code	HBA90
Beam angle	90°
Finish	Silver
Construction material	Aluminium
Weight	0.57Kg
Guarantee	1 year guarantee

USE WITH

HB20040	346
HB15040	347
HB10040	348

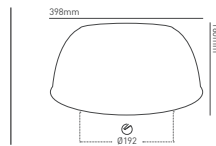

HBA60

Accessory for a intensive beam of light

FEATURES

Product code	HBA60
Beam angle	60°
Finish	Silver
Construction material	Aluminium
Weight	0.52Kg
Guarantee	1 year guarantee

USE WITH

HB20040	346
HB15040	347
HB10040	348

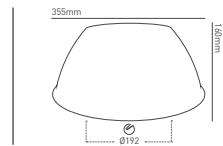

HBA70

A diffuser accessory for mounting a high bay low down, to prevent glare

FEATURES

Product code	HBA70
Beam angle	70°
Finish	Translucent
Construction material	Plastic
Weight	0.90Kg
Guarantee	1 year guarantee

USE WITH

HB20040	346
HB15040	347
HB10040	348

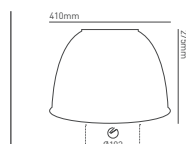

HBAS & HBASDHS

Microwave sensor to save energy and cost

FEATURES

Product code	HBAS
Wattage	200W
Finish	White
Construction material	Plastic
Weight	0.20Kg
Guarantee	1 year guarantee

USE WITH

HB20040	346
HB15040	347
HB10040	348

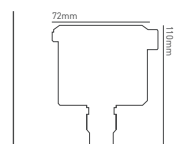

Lentus.

Low bays

The Lentus low bays combine excellent performance with quick payback.

New technology

LED technology and modern electronics drives down the lifetime running cost of the fittings. 150lm/W maximises the usage of electricity and light output to achieve an effective lit environment whilst minimising costs.

Cost savings also arise from the 50,000 LED lifetime at L70B10, reinforced by a five year extended warranty. The long lifetime of the fittings results in fewer replacements over time, reducing both the cost of buying and installing new fittings.

The table below shows an example of the costs savings which can be achieved:

Energy rate £/kWh: £0.15	Existing fitting	Our fitting
Average lamp life	12,000 hours	50,000 hours
Quantity of fittings	100	100
Watts per fitting	400W	150W
Energy £/Year	£26,928	£9,180

Easy installation

Lightweight

With its unique and skilful design, the Lentus low bay is extremely lightweight, allowing easy installation and maintenance whilst providing high lumen output.

Aisle spaces

Weighing as little as 2.5kg, the Lentus low bay is ideal for aisle spaces.

Compact

Smaller in size, so it can be installed by an individual.



Choosing the ideal low bay

The Lentus low bay is available in 100W and 150W outputs, with three beam angles available, 120°, 90° and 50°x90°. It can be surface mounted, or pendant mounted with the supplied strings, suiting a variety of environments.

Use the graph below to choose your ideal low bay, or for a consultation on your requirements, contact our expert team today. The designers inside The Studio at Collingwood are able to offer expertise throughout the lighting design process, putting together full schemes based around our comprehensive product range. Detailed client consultation ensures a high quality and tailored service.

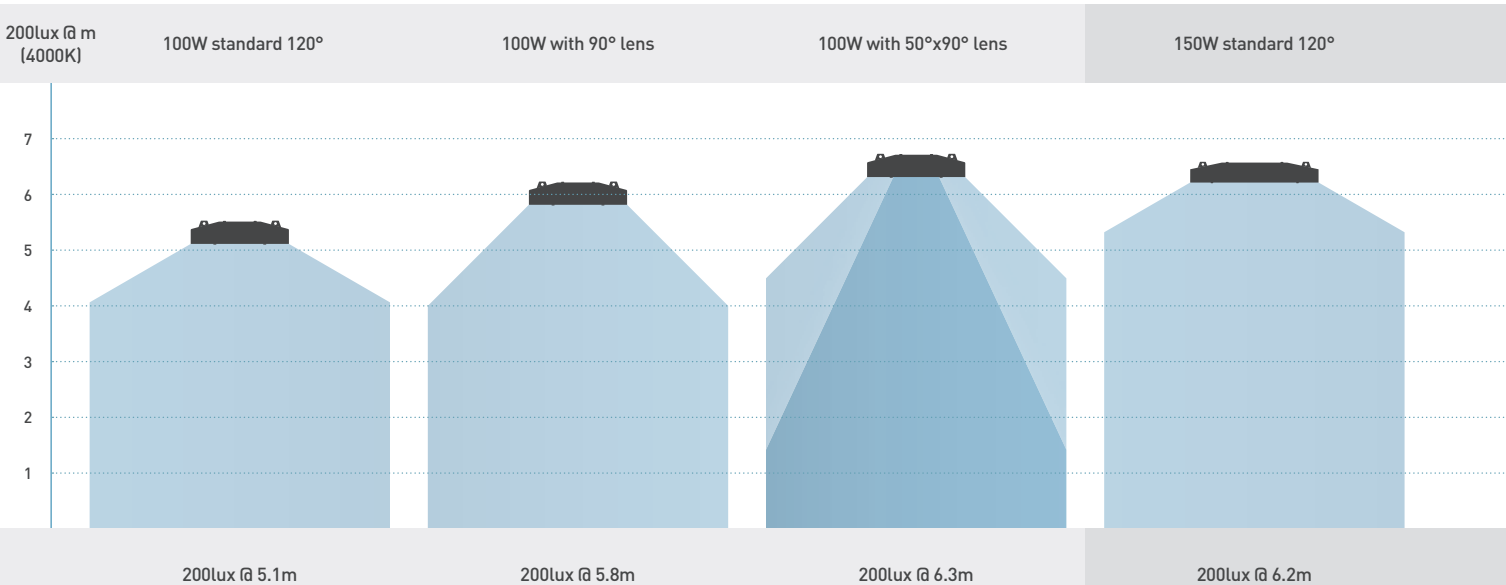

Beam angles

Offering three different beam angles, the Lentus low bay can be used for general lighting (symmetric 120° or 90°) or aisles (asymmetric 50°x90°).

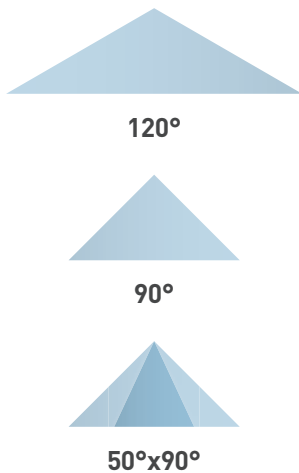

3-in-1 dimming

As standard, the Lentus low bays offer 1-10V, PWM and resistor dimming technologies in a single driver, providing flexibility of control.

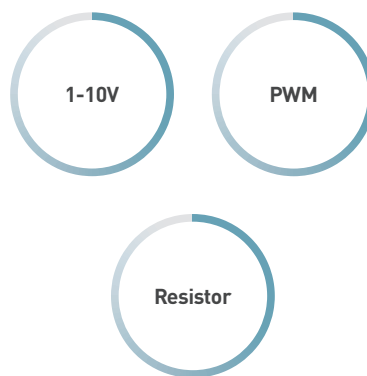

Flicker free

In line with Collingwood values, the best electrical components have been included in the product design. This has resulted in our confidence to assert that the low bays are flicker free fittings.

Having flicker free low bays results in a more comfortable working environment and increases employee satisfaction and productivity.



Microwave-sensor

Save energy and money

The low bay sensor accessory maximises energy savings in one single, fully programmable unit.

Step dimming

The sensor detects movement and allows the user to set up two step-dim parameter.

Daylight harvesting

The daylight harvesting feature controls the luminaire light output, adjusting the signal accordingly with the natural light.

Timer control

Stand-by times can be set by the user.

Remote control

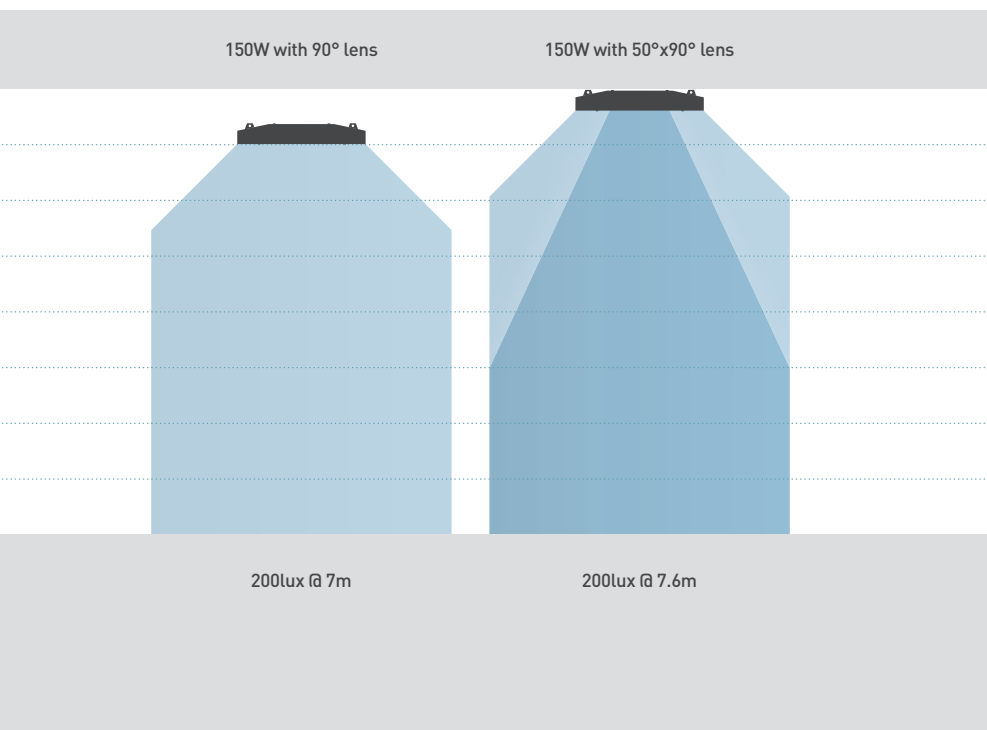

All functions are programmable by a user friendly remote controller.

For more information, see page 341.



Low bays.

01604 495 151
collingwoodlighting.com

-  @collingwoodLED
 /collingwoodlighting
 collingwoodled

GUARANTEE / WARRANTY

5 year extended guarantee
2 years guarantee on battery

FEATURES & BENEFITS

A range of mounting options available allowing excellent flexibility on installation

Specifically designed for use in aisle spaces

A range of accessories available

Highly efficient, up to 150lm/W

1-10V, PWM and resistor dimmable as standard, 3-in-1

Emergency lumens output: 640lm

Surge protection
L/N-PE = 10KV
L-N = 6KV



Lentus 150W

Linear low bay lighting, dimmable as standard 3-in-1

FEATURES

Wattage	150W
IP rating	IP40
IK rating	IK08
Colour flexibility	Fixed colour
Dimmable	1-10V, PWM & Resistor
Input	220-240 V~ Surge protection 6KV/10KV
LED lifetime	50,000h L70 B10
SDCM	5SDCM
Emergency version available	Yes

INSTALLATION INFORMATION

Install connector type	Std - Flying Lead EM - Push-fit Term
Inrush current	110A 0.2ms
Construction material	Aluminium
Weight	2.70Kg
Maximum ambient temperature	Std -40°C to +50°C Em 0°C to +40°C
SELV	Yes
Building regulations	Part P
Electric class (1, 2, 3)	1

PHOTOMETRICS @ 25°C

Product code	Finish	Wattage	Colour	Beam angle	CRI	lm	lm/W	lx at 1m
LB15040	White	150W	4000K	120°	80Ra	22000	147	7584
LB15040E	White	150W	4000K	120°	80Ra	22000	147	7584

WIRING INFORMATION

Cable / flying lead	Standard: 400mm H05RN-F 3x1.0mm ² Ø7mm Emergency: Push-fit terminals 4x 0.75-2.5mm ²
Type of wiring required	Parallel

ACCESSORIES

LBAL90	Replacement Lens 90° beam angle	Sold separately	354
LBAL5090	Replacement Lens 50°x90° beam angle	Sold separately	354
LBAHK	Suspension kit	Included	
LBAS	Microwave sensor	Sold separately	354
LBASDHS	Microwave & Daylight harvesting sensor	Sold separately	354
HBASDHSRC	Microwave & Daylight harvesting sensor controller	Sold separately	354

Beam angle: 120°

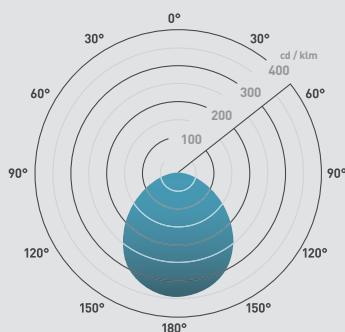



Lentus 100W

Linear low bay lighting, dimmable as standard 3-in-1

FEATURES

Wattage	100W
IP rating	IP40
IK rating	IK08
Colour flexibility	Fixed colour
Dimmable	1-10V, PWM & Resistor
Input	220-240 V~ Surge protection 6KV/10KV
LED lifetime	50,000h L70 B10
SDCM	5SDCM
Emergency version available	Yes

INSTALLATION INFORMATION

Install connector type	Std - Flying Lead EM - Push-fit Term
Inrush current	70A 0.2ms
Construction material	Aluminium
Weight	2.57Kg
Maximum ambient temperature	Std -40°C to +50°C Em 0°C to +40°C
SELV	Yes
Building regulations	Part P
Electric class [1, 2, 3]	1

PHOTOMETRICS @ 25°C

Product code	Finish	Wattage	Colour	Beam angle	CRI	lm	lm/W	Lx at 1m
LB10040	White	100W	4000K	120°	80Ra	15000	150	5171
LB10040E	White	100W	4000K	120°	80Ra	15000	150	5171

WIRING INFORMATION

Cable / flying lead	Standard: 400mm H05RN-F 3x1.0mm ² Ø7mm Emergency: Push-fit terminals 4x 0.75-2.5mm ²
Type of wiring required	Parallel

ACCESSORIES

LBAL90	Replacement Lens 90° beam angle	Sold separately	354
LBAL5090	Replacement Lens 50°x90° beam angle	Sold separately	354
LBAHK	Suspension kit	Included	
LBAS	Microwave sensor	Sold separately	354
LBASDHS	Microwave & Daylight harvesting sensor	Sold separately	354
HBASDHSRC	Microwave & Daylight harvesting sensor controller	Sold separately	354

Low bays.

01604 495 151
collingwoodlighting.com

- @collingwoodLED
- /collingwoodlighting
- collingwoodled

GUARANTEE / WARRANTY

5 year extended guarantee
2 years guarantee on battery

FEATURES & BENEFITS

A range of mounting options available allowing excellent flexibility on installation
Specifically designed for use in aisle spaces

A range of accessories available

Highly efficient, up to 150lm/W

1-10V, PWM and resistor dimmable as standard, 3-in-1

Emergency lumens output: 640lm

Surge protection
L/N-PE = 10KV
L-N = 6KV

Beam angle: 120°

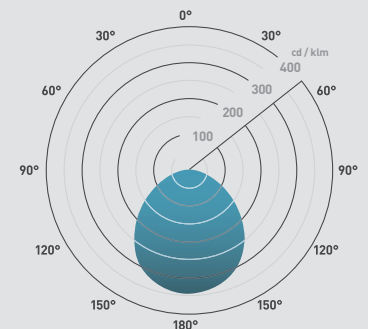

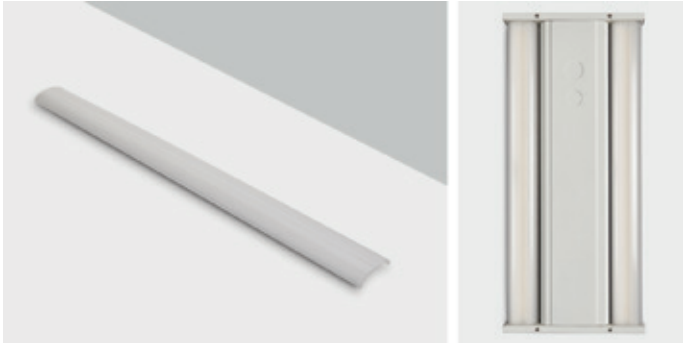

LBAL90

Lens to change beam angle to 90°

FEATURES

Product code	LBAL90
Beam angle	90°
Finish	White
Construction material	Plastic
Weight	0.16Kg
Guarantee	1 year guarantee

USE WITH

LB10040	352
LB15040	353

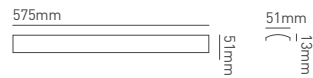

LBAL5090

Lens to change beam angle to 50x90°

FEATURES

Product code	LBAL5090
Beam angle	50x90°
Finish	White
Construction material	Plastic
Weight	0.16Kg
Guarantee	1 year guarantee

USE WITH

LB10040	352
LB15040	353

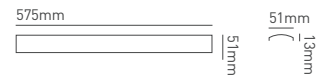

LBAS & LBASDHS

Microwave sensor to save energy and cost

FEATURES

Product code	LBAS: Microwave sensor LBASDHS: Microwave and daylight harvesting sensor
IP rating	IP65
Finish	White
Construction material	Plastic
Weight	0.20Kg
Guarantee	1 year guarantee

USE WITH

LB10040	352
LB15040	353

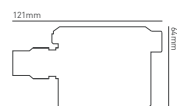



K2.

Floodlights

Our range of industrial floodlights throw light precisely where it is needed, with minimum installation and running costs.

Choosing the ideal floodlight

The K2 floodlights are available in 100W, 150W and 200W outputs, with two beam angles available, 120° and 100°x150°. With a market-leading efficacy of 114lm/W, the K2 floodlight maximises the usage of electricity and light output to achieve an effective lit environment whilst minimising costs.

Use the diagram below to determine which output is suitable for your installation, or for a consultation on your requirements, contact our expert team today. The designers inside The Studio at Collingwood are able to offer expertise throughout the lighting design process, putting together full schemes based around our comprehensive product range. Detailed client consultation ensures a high quality and tailored service.

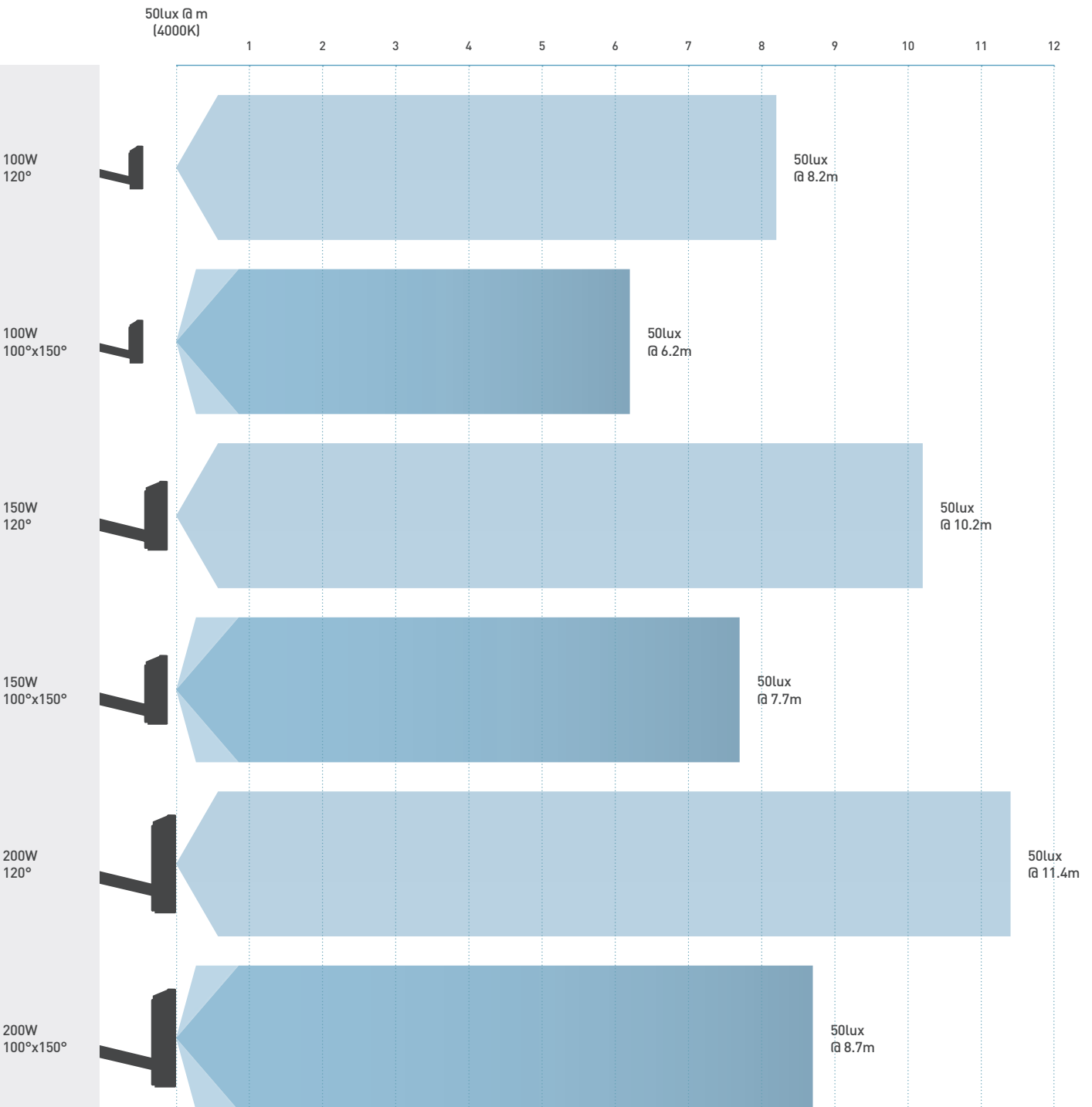

Beam angles

Available in 120° or 100°x150° beam angles.

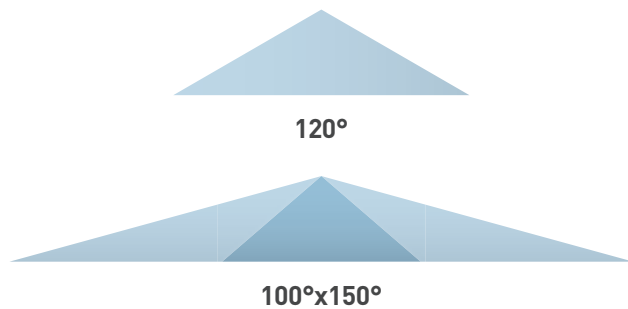

Easy installation

Tool free access

The skilfully designed bracket simplifies the floodlight installation, cutting down costs and time, by allowing direct free tools access to the fixing screws.

Angle stamped bracket

The floodlights have additional features included such as the mounting angles, which are stamped on the adjustable bracket for precise angles, along with star washers so the bracket can stay in the same position once angled.

1m cable

Installing the K2 floodlights couldn't be easier with a 1m of cable included for ease of installation, and backed with Collingwood's quality, a nickel-plated cable gland is included.



IP65

Durable and versatile, the K2 floodlights are IP65 rated and are suitable for outdoors, whether it is for a large warehouse, loading bays, or car parks.

The breather vent maintains the IP65 rating and prevents condensation. This prevents product losing output or product failure.



Windage factors

The windage factor for our range of K2 floodlights are as followings: 100W 1.10 sq.ft, 150W 1.31sq ft and 200W 1.66 sq.ft.

Versatility

The floodlights are suitable to illuminate external areas of warehouses and industrial locations, parking areas, pathways and machinery in general. They can be easily fixed to walls and poles. Our floodlights are equipped with a practical dusk-down sensor, allowing automatic light control without any external command.

Loading bays



Car parks





Uplighting buildings



Floodlights.

01604 495 151
collingwoodlighting.com

-  @collingwoodLED
-  /collingwoodlighting
-  collingwoodled

GUARANTEE / WARRANTY

5 year extended guarantee

FEATURES & BENEFITS

Robust and can withstand tough environments

Ratchet points on bracket, tightened by allen key

Highly efficient 111lm/W

Surge protection
L/N-PE = 10KV
L-N = 6KV



K2 200W

Industrial floodlight, up to 114lm/W, IP65 & IK08 rated

FEATURES

Wattage	200W
IP rating	IP65
IK rating	IK08
Dimmable	No
Input	220-240 V~ Surge protection 6KV/10KV
LED lifetime	50,000h L70 B10
SDCM	3SCDM
Flicker Free	Yes
Emergency version available	No

INSTALLATION INFORMATION

Install connector type	Flying lead
Inrush current	120A 0.2ms
Construction material	Aluminium alloy Tempered glass
Weight	5.60Kg
Maximum ambient temperature	-40°C to +50°C
SELV	Yes
Building regulations	Part P
Electric class (1, 2, 3)	1

PHOTOMETRICS @ 25°C

Product code	Finish	Wattage	Colour	Beam angle	CRI	lm	lm/W	lx at 1m
IFL20BX40	Black	200W	4000K	120°	80Ra	22200	111	6550
IFL20BX40100150	Black	200W	4000K	100°x150°	80Ra	22200	111	3768
IFL20BX30	Black	200W	3000K	120°	80Ra	22200	111	6550
IFL20BX30100150	Black	200W	3000K	100°x150°	80Ra	22200	111	3768

WIRING INFORMATION

Cable / flying lead	1000mm H05RN-F 3x1.0mm ² Ø7mm
Type of wiring required	Parallel

ACCESSORIES

N/A	No accessories required
-----	-------------------------

Beam angle: 120° 100°x150°

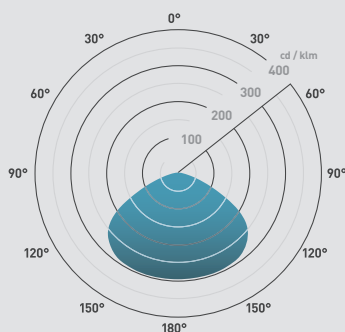

330mm

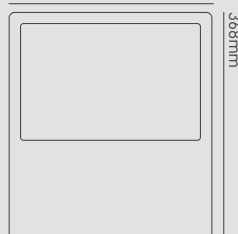



K2 150W

Industrial floodlight, up to 114lm/W, IP65 & IK08 rated

FEATURES

Wattage	150W
IP rating	IP65
IK rating	IK08
Dimmable	No
Input	220-240 V~ Surge protection 6KV/10KV
LED lifetime	50,000h L70 B10
SDCM	3SCDM
Flicker Free	Yes
Emergency version available	No

INSTALLATION INFORMATION

Install connector type	Flying lead
Inrush current	110A 0.2ms
Construction material	Aluminium alloy Tempered glass
Weight	5.00Kg
Maximum ambient temperature	-40°C to +50°C
SELV	Yes
Building regulations	Part P
Electric class (1, 2, 3)	1

PHOTOMETRICS @ 25°C

Product code	Finish	Wattage	Colour	Beam angle	CRI	lm	lm/W	lx at 1m
IFL15BX40	Black	150W	4000K	120°	80Ra	17100	114	5235
IFL15BX40100150	Black	150W	4000K	100°x150°	80Ra	17100	114	2966
IFL15BX30	Black	150W	3000K	120°	80Ra	17100	114	5235
IFL15BX30100150	Black	150W	3000K	100°x150°	80Ra	17100	114	2966

WIRING INFORMATION

Cable / flying lead	1000mm H05RN-F 3x1.0mm ² Ø7mm
Type of wiring required	Parallel

ACCESSORIES

N/A	No accessories required
-----	-------------------------

Floodlights.

01604 495 151
collingwoodlighting.com

@collingwoodLED

/collingwoodlighting

collingwoodled

GUARANTEE / WARRANTY

5 year extended guarantee

FEATURES & BENEFITS

Robust and can withstand tough environments

Ratchet points on bracket, tightened by allen key

Highly efficient 114lm/W

Surge protection
L/N-PE = 10KV
L-N = 6KV

Beam angle: 120° 100°x150°

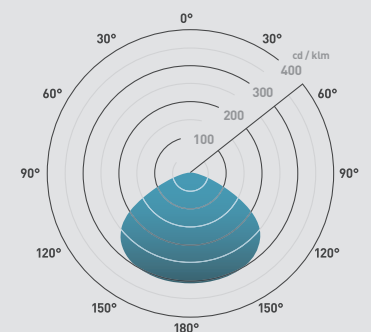

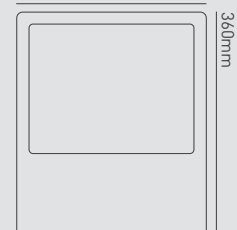

280mm



Floodlights.

01604 495 151
collingwoodlighting.com

 @collingwoodLED
 /collingwoodlighting
 collingwoodled

GUARANTEE / WARRANTY

5 year extended guarantee

FEATURES & BENEFITS

Robust and can withstand tough environments

Ratchet points on bracket, tightened by allen key

Highly efficient 114lm/W

Surge protection
L/N-PE = 10KV
L-N = 6KV



K2 100W

Industrial floodlight, up to 114lm/W, IP65 & IK08 rated

FEATURES

Wattage	100W
IP rating	IP65
IK rating	IK08
Dimmable	No
Input	220-240 V~ Surge protection 6KV/10KV
LED lifetime	50,000h L70 B10
SDCM	3SCDM
Flicker Free	Yes
Emergency version available	No

INSTALLATION INFORMATION

Install connector type	Flying lead
Inrush current	70A 0.2ms
Construction material	Aluminium alloy Tempered glass
Weight	4.00Kg
Maximum ambient temperature	-40°C to +50°C
SELV	Yes
Building regulations	Part P
Electric class (1, 2, 3)	1

PHOTOMETRICS @ 25°C

Product code	Finish	Wattage	Colour	Beam angle	CRI	lm	lm/W	lx at 1m
IFL10BX40	Black	100W	4000K	120°	80Ra	11400	114	3402
IFL10BX40100150	Black	100W	4000K	100°x150°	80Ra	11400	114	1950
IFL10BX30	Black	100W	3000K	120°	80Ra	11400	114	3402
IFL10BX30100150	Black	100W	3000K	100°x150°	80Ra	11400	114	1950

WIRING INFORMATION

Cable / flying lead	1000mm H05RN-F 3x1.0mm ² Ø7mm
Type of wiring required	Parallel

ACCESSORIES

N/A	No accessories required
-----	-------------------------

Beam angle: 120° 100°x150°

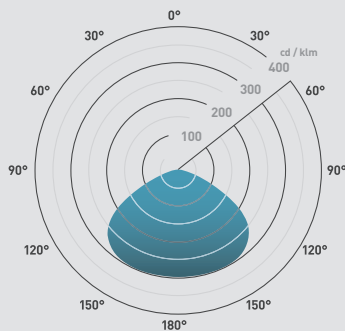

285mm

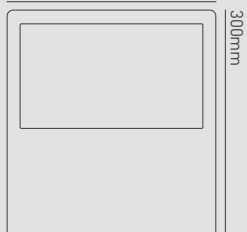



35

34

33

32

Caiman.

Anti-corrosives

Our anti-corrosives are built to last in the toughest of environments, whilst providing excellent energy savings.

Old vs. new

The Caiman anti-corrosives are available in three lengths, each available in two widths, making them a perfect replacement of the T8 fluorescent lamp. With market-leading efficacy of up to 140lm/W, this range will provide the same amount of light, but use much less power, resulting in excellent cost savings and quick payback.

The table below shows an example of the costs savings which can be achieved:

Energy rate £/kWh: £0.15	Typical T8 fluorescent lamp	Our fitting
Average lamp life	12,000 hours	50,000 hours
Quantity of fittings	100	100
Watts per fitting	400W	150W
Energy £/Year	£26,928	£9,180

DALI

This range comes with both DALI and microwave sensor options.

DALI offers complete control of the lighting in your space, enabling you to control and monitor each fixture, individually. This is ideal for large multi-purpose spaces that require differing light levels or regular changes to the layout.

Microwave sensor

Our fully integrated microwave sensor further adds to the all important energy savings.

Perfect for car parks, the sensor will ensure these fixtures are only on when motion is detected, and allow the flexibility to adjust the detection area and hold time.

Choosing the ideal anti-corrosive

The range features three lengths: 1200mm, 1500mm and 1800mm (4ft, 5ft and 6ft) each of which is available in two widths, single and twin, which offer differing wattages depending on the light level required. In new applications the choice of length may be based on the size of the space they are being installed, for example bigger spaces may benefit from the longer 1800mm fixture, and the single or twin may be determined by the height of the ceiling, or the required lux level for the tasks that are being carried out beneath.

These options are also ideal for retrofit applications where the length and width can be matched to the fixture, allowing for a quick replacement without the need for new wiring.

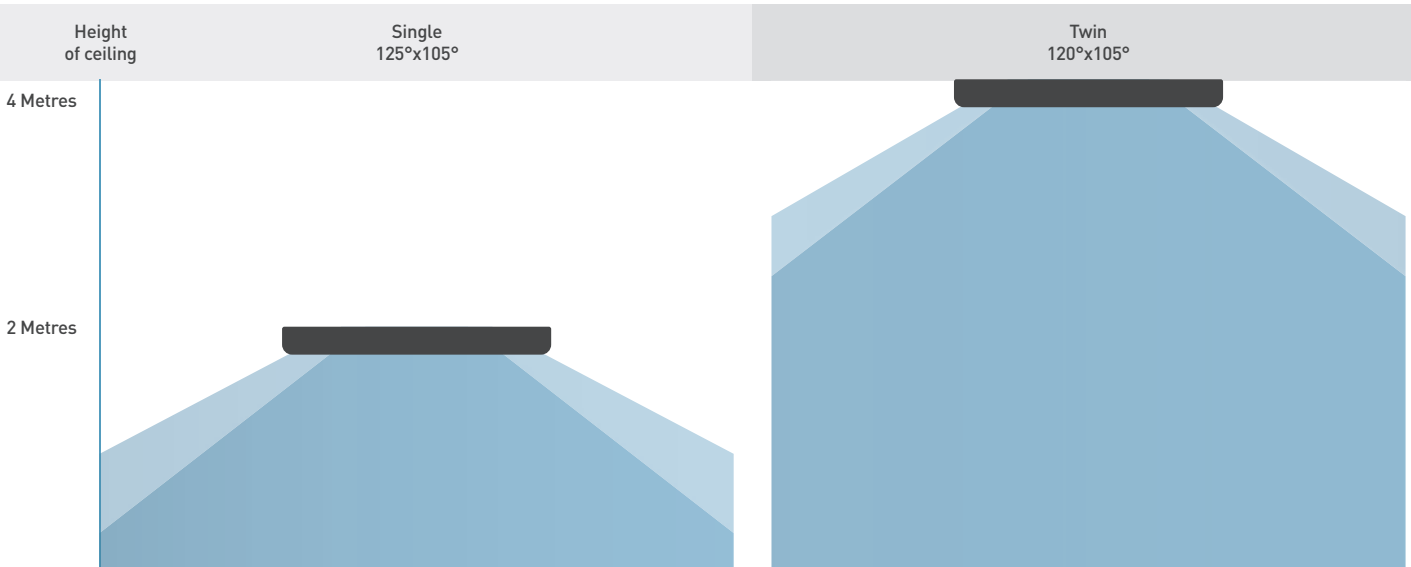

Mounting options

Our anti-corrosives offer versatility with several mounting and wiring options.

Stainless steel mounting brackets and hanging brackets are supplied with each fixture, so the anti-corrosives can be surface mounted directly onto the ceiling, or they can be suspended if the location has a high ceiling.

Surface mounted



Suspended

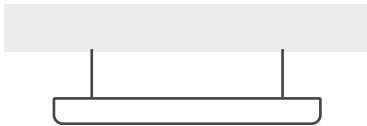

Cable entry

Cable entry points from either side and the back of the fixture enables this product to satisfy many installation requirements, giving the option to conceal wiring behind the fixture or link them together via their loop-in loop-out terminal.

Two compression cable glands are supplied as standard to help maintain the IP65 rating whilst reducing tension on the cables.

Rear cable entry



Side cable entry



Flicker free

In line with Collingwood values, the best electrical components have been included in the product design. This has resulted in our confidence to assert that the anti-corrosives are flicker free fittings.

Having flicker free anti-corrosives, results in a more comfortable working environment, and increases employee satisfaction and productivity.



IK08

Designed to withstand tough environments, the Caiman is comprised of a polycarbonate base and diffuser. This material is high impact-resistant whilst maintaining flexibility at room temperature, unlike acrylic which is brittle, enabling our fixtures to tolerate movement and impact without shattering, cracking or breaking.



IP65

The robust base and diffuser of the Caiman is tightly held together with anti-tamper stainless steel clips. Further protection against moisture ingress is provided by a rubber seal and compression cable glands.



5 year extended warranty

The 5 year extended warranty available with this range gives piece of mind that these tough fixtures will stand the test of time, even when faced with harsh environments.





Emergency option

Essential for many industrial spaces, it is vital to keep the area illuminated in the event of an emergency or loss of power. That's why we have an emergency version available for all three operating options; standard, microwave sensor and DALI.

The emergency versions will remain illuminated for a minimum of three hours and their convenient self-test feature will ensure that any failings will be clearly evident via the internal indicator light.

Anti-corrosives.

01604 495 151
collingwoodlighting.com

-  @collingwoodLED
 /collingwoodlighting
 collingwoodled

GUARANTEE / WARRANTY

5 year extended warranty

FEATURES & BENEFITS

Robust fixture made of polycarbonate base and translucent polycarbonate diffuser

Held together with anti-tamper stainless steel clips allowing the removal of the diffuser during installation

Tough exterior provides an IP65 and IK08 housing protecting the LED components inside

Compression cable glands allowing the entry/exit of wires without compromising water tightness of the fixture

Mounting brackets included

Available with microwave sensor for further energy savings

Loop-in loop-out terminals

Beam angle: 125x105°

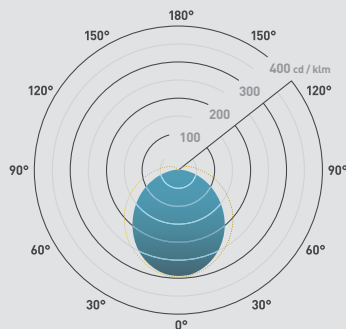

Caiman 4ft 17-18W

4ft Single, anti-corrosive LED

FEATURES

Wattage	17 - 18W
IP rating	IP65
IK rating	IK08
Colour flexibility	Fixed colour
UGR	19
Dimmable	DALI option
Input	220-240V
LED lifetime	50,000h L70 B10
SDCM	5SDCM
Emergency version available	Yes

INSTALLATION INFORMATION

Install connector type	Loop-in loop-out
Inrush current	5.5A, 40µs DALI : 20A, 140µs
Construction material	PC Stainless Steel
Weight	1221g
Maximum ambient temperature	40°C
SELV	Yes
Building regulations	Part P
Electric class (1, 2, 3)	1

PHOTOMETRICS @ 25°C

Product code	Wattage	Feature	Colour	Beam angle	CRI	lm	lm/W	Lx at 1m
AC4SS40	17W	Standard	4000K	125x105°	80Ra	2500	147	736
AC4SM40	18W	Microwave sensor	4000K	125x105°	80Ra	2500	147	736
AC4SD40	18W	DALI dimmable	4000K	125x105°	80Ra	2500	140	736
AC4SS40EM	17W	Emergency	4000K	125x105°	80Ra	2500	147	736
AC4SM40EM	18W	Emergency Microwave sensor	4000K	125x105°	80Ra	2500	147	736
AC4SD40EM	18W	Emergency DALI dimmable	4000K	125x105°	80Ra	2500	140	736

WIRING INFORMATION

Cable required for connector	H05RN-F cable diameter 4 - 10mm, max conductor size 3x 1.5mm ²
Type of wiring required	Parallel

ACCESSORIES

JB3	Waterproof junction box	Sold separately	422
-----	-------------------------	-----------------	---------------------



Caiman 4ft 33-35W

4ft Twin, anti-corrosive LED

FEATURES

Wattage	33 - 35W
IP rating	IP65
IK rating	IK08
Colour flexibility	Fixed colour
UGR	22
Dimmable	DALI option
Input	220-240V
LED lifetime	50,000h L70 B10
SDCM	5SDCM
Emergency version available	Yes

INSTALLATION INFORMATION

Install connector type	Loop-in loop-out
Inrush current	11A, 150µs DALI : 23A, 200µs
Construction material	PC Stainless Steel
Weight	1758.5g
Maximum ambient temperature	40°C
SELV	Yes
Building regulations	Part P
Electric class [1, 2, 3]	1

PHOTOMETRICS @ 25°C

Product code	Wattage	Feature	Colour	Beam angle	CRI	lm	lm/W	lx at 1m
AC4TS40	35W	Standard	4000K	120x105°	80Ra	4600	131	1413
AC4TM40	33W	Microwave sensor	4000K	120x105°	80Ra	4600	131	1413
AC4TD40	33W	DALI dimmable	4000K	120x105°	80Ra	4600	140	1413
AC4TS40EM	35W	Emergency	4000K	120x105°	80Ra	4600	131	1413
AC4TM40EM	33W	Emergency Microwave sensor	4000K	120x105°	80Ra	4600	131	1413
AC4TD40EM	33W	Emergency DALI dimmable	4000K	120x105°	80Ra	4600	140	1413

WIRING INFORMATION

Cable required for connector	H05RN-F cable diameter 4 - 10mm, max conductor size 3x 1.5mm ²
Type of wiring required	Parallel

ACCESSORIES

JB3	Waterproof junction box	Sold separately	422
-----	-------------------------	-----------------	-----

Anti-corrosives.

01604 495 151
collingwoodlighting.com

- @collingwoodLED
- /collingwoodlighting
- collingwoodled

GUARANTEE / WARRANTY

5 year extended warranty

FEATURES & BENEFITS

Robust fixture made of polycarbonate base and translucent polycarbonate diffuser

Held together with anti-tamper stainless steel clips allowing the removal of the diffuser during installation

Tough exterior provides an IP65 and IK08 housing protecting the LED components inside

Compression cable glands allowing the entry/exit of wires without compromising water tightness of the fixture

Mounting brackets included

Available with microwave sensor for further energy savings

Loop-in loop-out terminals

Beam angle: 120x105°

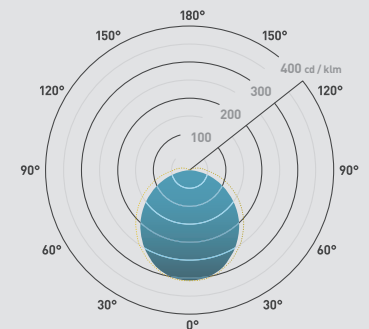



1250mm

115mm
78mm

Anti-corrosives.

01604 495 151
collingwoodlighting.com

 @collingwoodLED
 /collingwoodlighting
 collingwoodled

GUARANTEE / WARRANTY

5 year extended warranty

FEATURES & BENEFITS

Robust fixture made of polycarbonate base and translucent polycarbonate diffuser

Held together with anti-tamper stainless steel clips allowing the removal of the diffuser during installation

Tough exterior provides an IP65 and IK08 housing protecting the LED components inside

Compression cable glands allowing the entry/exit of wires without compromising water tightness of the fixture

Mounting brackets included

Available with microwave sensor for further energy savings

Loop-in loop-out terminals

Beam angle: 125x105°

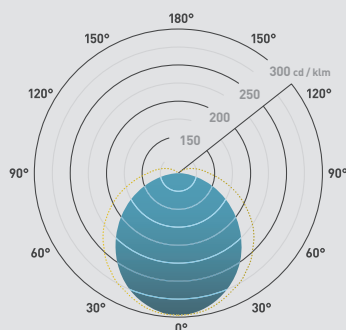

1570mm  78mm 

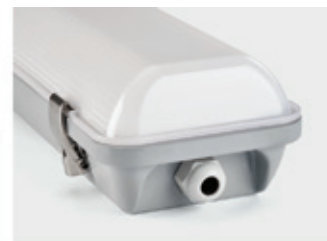

Caiman 5ft 28-29W

5ft Single, anti-corrosive LED

FEATURES

Wattage	28 - 29W
IP rating	IP65
IK rating	IK08
Colour flexibility	Fixed colour
UGR	20
Dimmable	DALI option
Input	220-240V
LED lifetime	50,000h L70 B10
SDCM	5SDCM
Emergency version available	Yes

INSTALLATION INFORMATION

Install connector type	Loop-in loop-out
Inrush current	11A, 150µs DALI : 26A, 160µs
Construction material	PC Stainless Steel
Weight	1713g
Maximum ambient temperature	40°C
SELV	Yes
Building regulations	Part P
Electric class (1, 2, 3)	1

PHOTOMETRICS @ 25°C

Product code	Wattage	Feature	Colour	Beam angle	CRI	lm	lm/W	Lx at 1m
AC5SS40	28W	Standard	4000K	125x105°	80Ra	4000	143	1135
AC5SM40	29W	Microwave sensor	4000K	125x105°	80Ra	4000	143	1135
AC5SD40	28W	DALI dimmable	4000K	125x105°	80Ra	4000	143	1135
AC5SS40EM	28W	Emergency	4000K	125x105°	80Ra	4000	143	1135
AC5SM40EM	29W	Emergency Microwave sensor	4000K	125x105°	80Ra	4000	143	1135
AC5SD40EM	28W	Emergency DALI dimmable	4000K	125x105°	80Ra	4000	143	1135

WIRING INFORMATION

Cable required for connector	H05RN-F cable diameter 4 - 10mm, max conductor size 3x 1.5mm ²
Type of wiring required	Parallel

ACCESSORIES

JB3	Waterproof junction box	Sold separately	422
-----	-------------------------	-----------------	---------------------



Caiman 5ft 48-50W

5ft Twin, anti-corrosive LED

FEATURES

Wattage	48 - 50W
IP rating	IP65
IK rating	IK08
Colour flexibility	Fixed colour
UGR	22
Dimmable	DALI option
Input	220-240V
LED lifetime	50,000h L70 B10
SDCM	5SDCM
Emergency version available	Yes

INSTALLATION INFORMATION

Install connector type	Loop-in loop-out
Inrush current	12.6A, 150µs DALI : 26A, 300µs
Construction material	PC Stainless Steel
Weight	2260.5g
Maximum ambient temperature	40°C
SELV	Yes
Building regulations	Part P
Electric class [1, 2, 3]	1

PHOTOMETRICS @ 25°C

Product code	Wattage	Feature	Colour	Beam angle	CRI	lm	lm/W	lx at 1m
AC5TS40	50W	Standard	4000K	120x105°	80Ra	7000	140	2159
AC5TM40	50W	Microwave sensor	4000K	120x105°	80Ra	7000	140	2159
AC5TD40	48W	DALI dimmable	4000K	120x105°	80Ra	7000	146	2159
AC5TS40EM	50W	Emergency	4000K	120x105°	80Ra	7000	140	2159
AC5TM40EM	50W	Emergency Microwave sensor	4000K	120x105°	80Ra	7000	140	2159
AC5TD40EM	48W	Emergency DALI dimmable	4000K	120x105°	80Ra	7000	146	2159

WIRING INFORMATION

Cable required for connector	H05RN-F cable diameter 4 - 10mm, max conductor size 3x 1.5mm ²
Type of wiring required	Parallel

ACCESSORIES

JB3	Waterproof junction box	Sold separately	422
-----	-------------------------	-----------------	-----

Anti-corrosives.

01604 495 151
collingwoodlighting.com

- @collingwoodLED
- /collingwoodlighting
- collingwoodled

GUARANTEE / WARRANTY

5 year extended warranty

FEATURES & BENEFITS

Robust fixture made of polycarbonate base and translucent polycarbonate diffuser

Held together with anti-tamper stainless steel clips allowing the removal of the diffuser during installation

Tough exterior provides an IP65 and IK08 housing protecting the LED components inside

Compression cable glands allowing the entry/exit of wires without compromising water tightness of the fixture

Mounting brackets included

Available with microwave sensor for further energy savings

Loop-in loop-out terminals

Beam angle: 120x105°

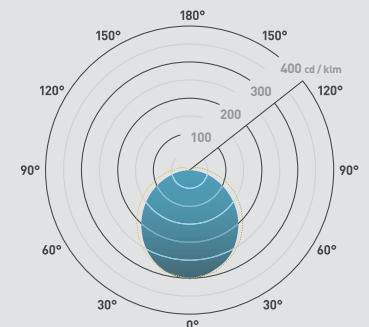



1570mm

115mm
78mm

Anti-corrosives.

01604 495 151
collingwoodlighting.com

 @collingwoodLED
 /collingwoodlighting
 collingwoodled

GUARANTEE / WARRANTY

5 year extended warranty

FEATURES & BENEFITS

Robust fixture made of polycarbonate base and translucent polycarbonate diffuser

Held together with anti-tamper stainless steel clips allowing the removal of the diffuser during installation

Tough exterior provides an IP65 and IK08 housing protecting the LED components inside

Compression cable glands allowing the entry/exit of wires without compromising water tightness of the fixture

Mounting brackets included

Available with microwave sensor for further energy savings

Loop-in loop-out terminals

Beam angle: 125x105°

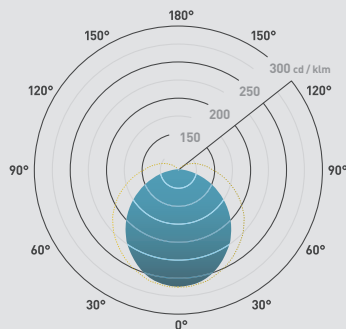

1870mm  78mm
78mm 



Caiman 6ft 36-37W

6ft Single, anti-corrosive LED

FEATURES

Wattage	36 - 37W
IP rating	IP65
IK rating	IK08
Colour flexibility	Fixed colour
UGR	20
Dimmable	DALI option
Input	220-240V
LED lifetime	50,000h L70 B10
SDCM	5SDCM
Emergency version available	Yes

INSTALLATION INFORMATION

Install connector type	Loop-in loop-out
Inrush current	11A, 150µs DALI : 23A, 200µs
Construction material	PC Stainless Steel
Weight	1945g
Maximum ambient temperature	40°C
SELV	Yes
Building regulations	Part P
Electric class (1, 2, 3)	1

PHOTOMETRICS @ 25°C

Product code	Wattage	Feature	Colour	Beam angle	CRI	lm	lm/W	Lx at 1m
AC6SS40	36W	Standard	4000K	125x105°	80Ra	5100	141	1343
AC6SM40	37W	Microwave sensor	4000K	125x105°	80Ra	5100	138	1343
AC6SD40	36W	DALI dimmable	4000K	125x105°	80Ra	5100	141	1343
AC6SS40EM	36W	Emergency	4000K	125x105°	80Ra	5100	141	1343
AC6SM40EM	36.5W	Emergency Microwave sensor	4000K	125x105°	80Ra	5100	140	1343
AC6SD40EM	36.5W	Emergency DALI dimmable	4000K	125x105°	80Ra	5100	140	1343

WIRING INFORMATION

Cable required for connector	H05RN-F cable diameter 4 - 10mm, max conductor size 3x 1.5mm ²
Type of wiring required	Parallel

ACCESSORIES

JB3	Waterproof junction box	Sold separately	422
-----	-------------------------	-----------------	---------------------



Caiman 6ft 55-60W

6ft Twin, anti-corrosive LED

FEATURES

Wattage	55 - 60W
IP rating	IP65
IK rating	IK08
Colour flexibility	Fixed colour
UGR	21
Dimmable	DALI option
Input	220-240V
LED lifetime	50,000h L70 B10
SDCM	5SDCM
Emergency version available	Yes

INSTALLATION INFORMATION

Install connector type	Loop-in loop-out
Inrush current	12.6A, 150µs DALI : 26A, 300µs
Construction material	PC Stainless Steel
Weight	2691.6g
Maximum ambient temperature	40°C
SELV	Yes
Building regulations	Part P
Electric class [1, 2, 3]	1

PHOTOMETRICS @ 25°C

Product code	Wattage	Feature	Colour	Beam angle	CRI	lm	lm/W	lx at 1m
AC6TS40	55W	Standard	4000K	120x105°	80Ra	8500	155	2339
AC6TM40	55W	Microwave sensor	4000K	120x105°	80Ra	8500	155	2339
AC6TD40	57W	DALI dimmable	4000K	120x105°	80Ra	8500	150	2339
AC6TS40EM	60W	Emergency	4000K	120x105°	80Ra	8500	141	2339
AC6TM40EM	60W	Emergency Microwave sensor	4000K	120x105°	80Ra	8500	141	2339
AC6TD40EM	60W	Emergency DALI dimmable	4000K	120x105°	80Ra	8500	141	2339

WIRING INFORMATION

Cable required for connector	H05RN-F cable diameter 4 - 10mm, max conductor size 3x 1.5mm ²
Type of wiring required	Parallel

ACCESSORIES

JB3	Waterproof junction box	Sold separately	422
-----	-------------------------	-----------------	-----

Anti-corrosives.

01604 495 151
collingwoodlighting.com

- @collingwoodLED
- /collingwoodlighting
- collingwoodled

GUARANTEE / WARRANTY

5 year extended warranty

FEATURES & BENEFITS

Robust fixture made of polycarbonate base and translucent polycarbonate diffuser

Held together with anti-tamper stainless steel clips allowing the removal of the diffuser during installation

Tough exterior provides an IP65 and IK08 housing protecting the LED components inside

Compression cable glands allowing the entry/exit of wires without compromising water tightness of the fixture

Mounting brackets included

Available with microwave sensor for further energy savings

Loop-in loop-out terminals

Beam angle: 120x105°

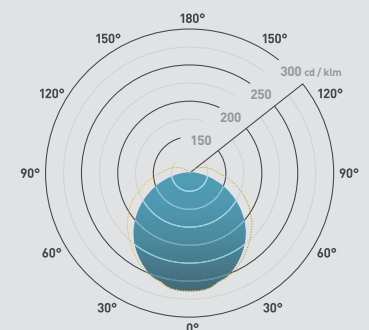

1870mm

115mm
78mm

Colour change.

Our RGBW range of colour change products provides increased flexibility to improve the atmosphere of indoor and outdoor spaces. The difference between RGB and RGBW is a white LED. Adding white to the colour mix gives the option to create pastel shades as well as vibrant colour choices. RGBW can also be run on white, giving you the option of more natural lighting when required.

To complement our RGBW products we also offer a new control system range. This makes it easy to create different lighting zones allowing individual control of separate areas using a single hand held control, wall mounted control or a smart device App for Android and iOS.



Eight easy steps.

Understanding colour change

To create exciting and diverse spaces.

Examples

See some great installations in our inspiration pages (page 32 - 65).

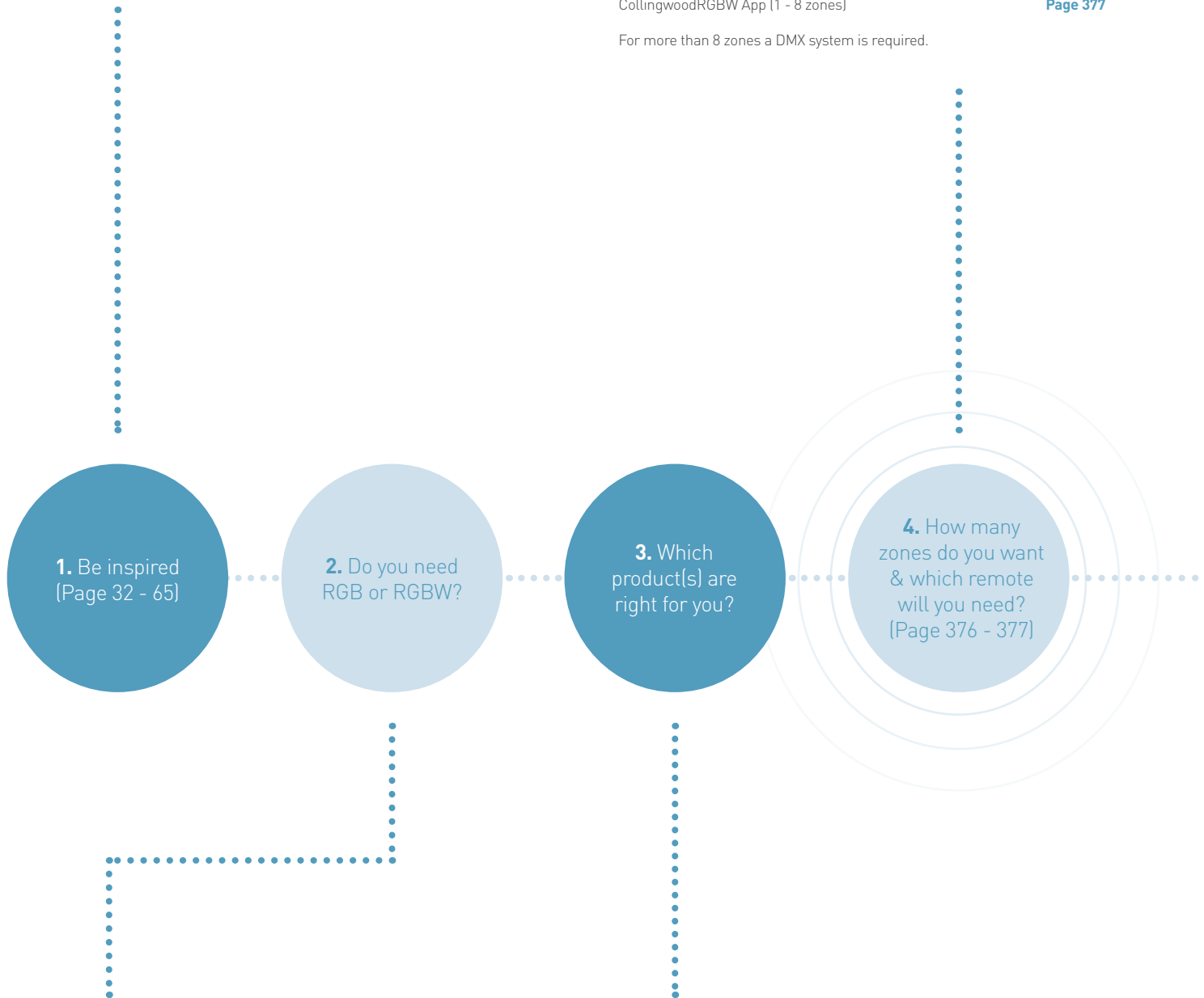

Remotes

Wall Mounted Remote Control (1 - 4 zones) [Page 376](#)

Hand Held Remote Control (1 - 6 zones) [Page 376](#)

CollingwoodRGBW App (1 - 8 zones) [Page 377](#)

For more than 8 zones a DMX system is required.



RGB

Use RGB products to select vivid red, green or blue schemes or mix the three together for even more colour options.



RGBW

The addition of a white LED in RGBW products provides the option for white light and pastel shades in addition to vivid red, green and blue colours.

Products

Ground Lights [Page 384 - 392](#)

Wall Lights [Page 393](#)

Pond Lights [Page 394 - 395](#)

Uplights [Page 396 - 398](#)

Strip Lights [Page 399 - 400](#)

Power repeaters

PR3011 [Page 380](#)

PR3002 [Page 381](#)

For all constant current products you will need the **PR3011** and for all constant voltage products you will need the **PR3002**.

24V Driver

PS1524 15W driver

PS5024 50W driver

PS10024 100W driver

PSIP15024 150W driver

You will need a 24V driver to power your controller / decoder. The number of power repeaters will determine which driver you need.

You will need **CF505RGBW (300mm)** cable to wire your controller / decoder to your power repeaters, and your power repeaters to each other (page 382).

You may also need extension cable (page 382).

5. Do you need a RF controller or a DMX decoder?
(Page 378-379)

6. Which power repeater do you need & how many of them?
(Page 380 - 381)

7. What cable will you need?
(Page 382 - 383)

8. Place your order

Controller / decoder

C100924 (controller) [Page 378](#)

DMX2102 (decoder) [Page 379](#)

For all installations using 1-8 zones you will need the **MC100924** controller.
If there is already a DMX control system in place or you plan to use more than 8 zones you will need the **DMX2102** decoder.

24V Driver

PS1524 15W driver

PS5024 50W driver

PS10024 100W driver

PSIP15024 150W driver

You will need a 24V driver to power your controller / decoder. The number of power repeaters will determine which driver you need.

If you need any help our team are on hand on **+44 (0) 1604 495 151**.

Complete process with C100924.

Remote to product

Remotes

How many zones / rooms do you need?

Which remote covers the number of zones you need?

Is a DMX control system already in place or do you need more than 8 zones? (Use a DMX control system in this case)

Controller

You will need one per zone.

Are you using an RF remote or a DMX control system? (Use the C100924 with RF remotes and the DMX2102 with DMX control systems)

What wattage driver do you need to power your controller / decoder?

Power repeaters

Are you using constant voltage or constant current products? (Use PR3002 for constant voltage products and PR3011 for constant current products)

You will need **CF505RGBW (300mm)** cable to connect each of your power repeaters.

What wattage driver(s) do you need to power your power repeaters?

Products

What products do you want?

You will need cable to connect your products to your power repeaters.

Avoid using RGB and RGBW products in the same zone as the colour may not always match.

Remotes



WC2820WH / WC2820BLK

Page 376



RC2819

Page 376



CollingwoodRGBW App

Page 377

with TR2818

Page 377



PS1524

15W driver

(TR2818 requires a driver)

Controller (Per zone)



Controller - C100924

Page 378

24V driver (Per zone)



PS1524

15W driver



PS5024

50W driver



PS10024

100W driver

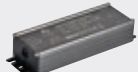

PSIP15024

150W driver

Per zone

Power repeaters
(Per zone)

Products



Power repeater - PR3011

Page 380



Power repeater - PR3011

Page 380



Power repeater - PR3002

Page 381

24V driver



PS1524
15W driver



PS5024
50W driver



PS10024
100W driver



PSIP15024
150W driver



Don't forget you will need 300mm extra CF505RGBW cable for every power repeater you use.



It is not advised to put RGB & RGBW products in the same zone as the colours will not always match.

Zones.

Remotes

A zone can cover any space you choose. They are often assigned to rooms so that you can have different colour settings for each room and be able to adjust them completely independently from one another using your remote control. For example...

House front



Zone 1

Living room



Zone 1

Kitchen



Zone 3

Bedroom 1



Zone 4

Remember you can assign any room to any zone number

Once you have decided how many zones you require, you will need to select a remote that is capable of covering that number of zones. You are able to use multiple remotes as long as they are all capable of covering the number of zones you have.

Wall mounted remote control - WC2820BLK / WC2820WH - 1-4 zones

Hand held remote control - RC2819 - 1-6 zones

CollingwoodRGBW app - with TR2818 (requires 15W driver) - 1-8 zones

Zone 1 / 1 Room

Zone 2 / 2 Rooms

Zone 3 / 3 Rooms

Zone 4 / 4 Rooms

WC2820WH / WC2820BLK

Wall mounted RGBW remote control

Controlling Collingwood Lighting's RGB & RGBW ranges could not be easier with this wall mounted remote control. Using radio frequency (RF) removes the need to connect a signal cable to the controller for a cleaner and quicker installation. By simply touching the screen, select solid colours or start a cycle to change the atmosphere. Colours can also be dimmed by holding down the colour button. Select up to 4 zones to give individuality to each room.

Note: The WC2820 requires 240V AC supply.

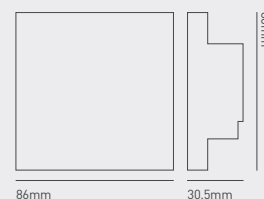
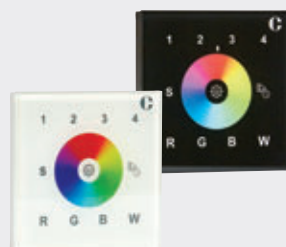

RC2819

Handheld remote control

Controlling RGB & RGBW lights on the move could not be easier with this remote control. Using RF removes the need to connect a signal cable to the controller for a cleaner and quicker installation. Select solid colours or start a colour changing cycle to create the perfect atmosphere. Colours can also be dimmed by holding down the colour button. From just one remote control you can select up to 6 different rooms and change the colours individually to suit. A maximum of 8 remote controls can be used and programmed to store your favourite colours.

Note: Requires 3x AAA batteries (not included)

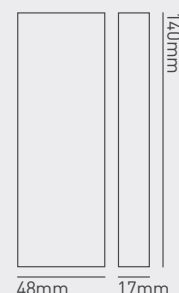
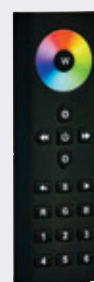



Got a query? Contact our team on +44 (0) 1604 495 151

Bedroom 2

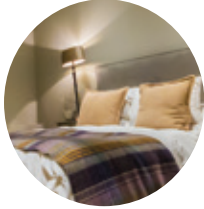

Zone 5

Garden



Zone 6

Dining room



Zone 7

Stairs / hallway



Zone 8

If you require more than 8 zones you will need to use a DMX control system



Zone 5 / 5 Rooms

Zone 6 / 6 Rooms

Zone 7 / 7 Rooms

Zone 8 / 8 Rooms

CollingwoodRGBW App

iPhone, iPad & Android app for wireless control

Control RGB & RGBW products with a smart device for up to 8 zones. By simply touching the screen, select solid colours, start a cycle or control lights via a sound to light option. The app can be downloaded for free on Android and iOS.

Note: Use in conjunction with TR2818.



TR2818

WiFi to RF transmitter

Controlling RGB & RGBW products with a phone, computer or tablet could not be easier with the TR2818. Simply add this unit into your Collingwood Lighting colour change installation and select millions of colours in comfort. Using the CollingwoodRGBW app simply connect directly to the TR2818 or via your own WiFi.

Note: The TR2818 requires a 15W driver such as the PS1524.

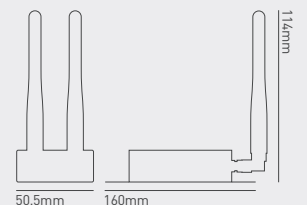

Controllers.

Do this
for each
zone

Which one and what power supply?

A controller is the device that receives a signal from your remote or DMX control system and then makes the LEDs match the colour you have set. You need one controller in each zone to adjust all of the LEDs in that zone.

You will have already decided how many zones you are going to have. If you are controlling eight or less zones then you will need the C100924 controller.

For 1 - 8 zones use the C100924 controller (1 controller per zone)

C100924 - RGB & RGBW Controller

The C100924 is essential to complete any Collingwood Lighting colour change installation. Receiving the signal from your remote control or device using radio frequency (RF) makes this a fast, simple and flexible method of achieving atmospheric lighting. By removing the need for complicated DMX systems, multi zone colour change can be achieved. Use the C100924 for each zone up to a maximum of 8. The C100924 works with both the PR3011 and the PR3002 power repeaters.

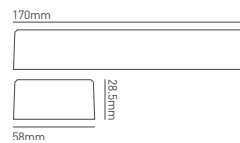

Don't forget your 24V driver to power your controller

Now that you know how many power repeaters you have in each zone you will be able to use the table to work out which 24V driver you will need to power your controller.

If you are using more than 100 power repeaters in a zone contact us for further help and information on **+44 (0) 1604 495 151**.

Number of power repeaters	Wattage driver needed	Product (driver)
1 - 10	15W	PS1524
11 - 30	50W	PS5024
31 - 60	100W	PS10024
61 - 100	150W	PSIP15024



PS1524
15W driver



PS5024
50W driver



PS10024
100W driver



PSIP15024
150W driver

When using a DMX control system only

Got a query? Contact our team on +44 (0) 1604 495 151

DMX2102 decoder (1 decoder per zone)

DMX2102 - RGB & RGBW DMX Decoder

Use the DMX2102 when using a DMX512 controller only. As part of your Collingwood Lighting colour change installation, simply replace the C100924 controller with the DMX2102 and create up to 512 channels, perfect for the larger installations and when an existing DMX controller is used. The DMX2102 works with both the PR3011 and the PR3002 power repeaters.

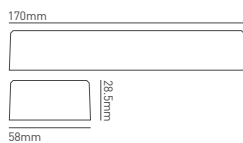

Don't forget your 24V driver to power your decoder

Now that you know how many power repeaters you have in each zone you will be able to use the table to work out which 24V driver you will need to power your controller.

If you are using more than 100 power repeaters in a zone contact us for further help and information on +44 (0) 1604 495 151.

Number of power decoders	Wattage driver needed	Product (driver)
1 - 10	15W	PS1524
11 - 30	50W	PS5024
31 - 60	100W	PS10024
61 - 100	150W	PSIP15024



PS1524
15W driver



PS5024
50W driver



PS10024
100W driver



PSIP15024
150W driver

Power repeaters.

Which one and how many?

Do this
for each
zone

Now you know which products you are going to use and how many of them you will be using in each zone, you can establish which power repeaters you need and work out how many of them you will require.

For all constant current products use the PR3011

PR3011 - 350mA RGB & RGBW Power repeater

A 350mA power supply for the RGB & RGBW product range. Simply wire up to 100 PR3011 to a C100924 for a quick and simple colour change installation, giving you the ability to have as many as 600 luminaires per zone.

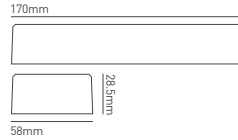

Calculate how many PR3011's you need for the products you have

Product code	Product family	Max. per PR3011
DL329RGBW	Downlight	6
GL007RGBW	Ground Light	2
GL008RGBW	Ground Light	1
GL016RGBW	Ground Light	6
GL040CARGB	Ground Light	6
GL050RGBW	Ground Light	6
GL090RGBW	Ground Light	2
LL030CARGB	Downlight	6
LL090RGBW	Downlight	2
UL010RGBW	Pond Light	6
UL030RGBW	Pond Light	2
UL345CARGB	Façade Light	1
UL346CARGB	Façade Light	1
UL347CARGB	Façade Light	1
WL070RGBW	Wall Light	1
WL075CARGB	Wall Light	2

For example:

If you had selected these products for your zone.



Using the table to the left we can see that you would need to spread them over the following power repeaters



This means you would need to order the following...



! Don't forget you'll need 300mm of CF505RGBW cable for every power repeater you use.

Don't forget your 24V driver to power your power repeater

Number of power repeaters	Wattage driver needed	Product (driver)
1	50W	PS5024
2-3	100W	PS10024
4-5	150W	PSIP15024

The products will be powered by power repeaters that require a 24V driver. The table shows you which driver you need for the number of power repeaters you are using. **If you require more than 5 power repeaters you will need another driver.**

In the example we calculated that we need 3 x PR3011. Using the table to the left we can see that we need a 100W driver. This means that you will need to order the following...

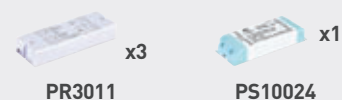



Got a query? Contact our team on
+44 (0) 1604 495 151

For all constant voltage products (strip lights) use the PR3002

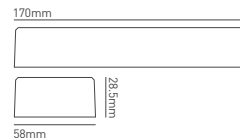

PR3002 - 24V RGB & RGBW Power repeater

A 24V power supply for the strip product range. Simply wire up to 100 to a C100924 for a quick and simple colour change installation, giving you the ability to have as many as 1000 metres of LED strip per zone.



Calculate how many PR3002's you need for the products you have and which driver you need to power your power repeaters

LSR05 (RGBW strip) - Bespoke lengths available

Length of strip per power repeater	Wattage driver needed	Product (driver)
Up to 2m per PR3002	50W	PS5024 
Up to 5m per PR3002	100W	PS10024 
Up to 10m per PR3002	150W	PSIP15024 

! For all strip, you can put up to 5m on one circuit per PR3002, but for 5-10m you will need to put the strip on two circuits per PR3002 (see product instructions).

! Don't forget you will need 300mm of CF505RGBW cable for every power repeater you use.

For example:

If you had selected these products for your zone.



Using the table to the left we can see that 10m of LSR05 strip would fully load a PR3002 so the remaining 3m of strip would need another PR3002 (using just under 50% of it).



This means you would need to order the following...



We are using 2 x PR3002. As you can see from the tables you will need a 150W driver for 10m of LSR05. The remaining 3m will need a 50W driver. This means you will need the following...



Wiring.

For your colour change products

You may need additional connectors and accessories to connect your colour change products

5-core PVC cable



CR575RGBW

5-core PVC cable

Product code	CR575RGBW
Construction material	Copper cable
Cable	PVC 5 x 0.75mm ²
Guarantee	1 year

Use in conjunction with:

All RGBW products	
JB7	423

Features & benefits

Suitable for extending cable on RGBW products.

5-core RGBW ribbon cable



CF505RGBW

5-core RGBW ribbon cable

Product code	CF505RGBW
Construction material	Copper cable
Cable	4x 0.3mm ² , 1x 0.5mm ² (black) ribbon cable
Guarantee	1 year

Use in conjunction with:

C100924	378
PR3011	380
PR3002	381

Features & benefits

Suitable for connecting C100924 to multiple PR3002 & PR3011.

Colour change extension lead for RGBW products



LEDRGBWEXT

Colour change extension lead for RGBW products

Product code	LEDRGBWEXT
Construction material	Copper cable
Cable	1m (AWG 24) (0.205mm ²)
Rated max voltage	300V
Rated temperature	80°C
Series / parallel	Series (Plug & play)
Guarantee	1 year

Use in conjunction with:

DL329RGBW	386
LL090RGBW	384
WL070RGBW	393

Features & benefits

Use multiple extensions for longer lead requirements.

Complete circuit with blanking plug.

Simple extension for series circuit.

5-core, RGBW and return.

4-core PVC cable



LED RGB 0.75 CABLE

4-core PVC cable

Product code	LED RGB 0.75 CABLE
Construction material	Copper cable
Cable	PVC 4 x 0.75mm ²
Guarantee	1 year

Use in conjunction with:

All RGBW products	
JB3	422

Features & benefits

Suitable for RGB wiring.

Can be wired to additional JB3 for multiple fittings.

Ideal for RGB applications.

Colour change extension lead for RGBW products



LED 3 RGB EXT

Colour change extension lead for RGB products

Product code	LED 3 RGB EXT
Construction material	Copper cable
Cable	1m (AWG 24) (0.205mm ²)
Rated max voltage	300V
Rated temperature	80°C
Series / parallel	Series (Plug & play)
Guarantee	1 year

NB: Removal of plugs will render this product non-returnable

Use in conjunction with:

LL030CARGB	385
------------	-----

Features & benefits

Use multiple extensions for longer lead requirements.

Complete circuit with blanking plug.

Simple extension for series circuit.

4-core. RGB and return.

3-core shielded cable



DMX RS 485 CABLE

3-core shielded cable

Product code	DMX RS 485 CABLE
Construction material	Copper cable
Cable	0.15mm ²
Guarantee	1 year

Use in conjunction with:

DMX2102	379
---------	-----

Features & benefits



Shielded cable.

Interference-free DMX signals (suitable for DMX2102).

Supplied on 100m reels (also available by the metre).

Colour change.

01604 495 151
collingwoodlighting.com

 @collingwoodLED
 /collingwoodlighting
 collingwoodled

GUARANTEE / WARRANTY

5 year extended warranty

FEATURES & BENEFITS

MR16 for retrofit into existing housings
Plug & play connectors for quick installation
Separate white LED for permanent use
Full RGBW colour range
Compatible with a large range of controllers

Beam angle: 25°

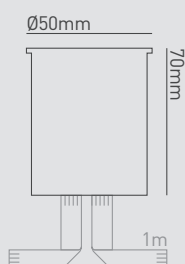
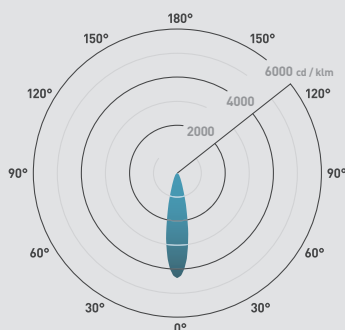

384



LL090RGBW

Colour change LED unit (13W max.)

FEATURES

Wattage (White)	3.3W
Wattage (Red)	2.4W
Wattage (Green)	3.3W
Wattage (Blue)	3.3W
IP rating	IP40
Colour flexibility	RGBW
Input	350mA
LED lifetime	50,000h L50 B50

INSTALLATION INFORMATION

Install Connector Type	Flying lead
Insulation Coverable	No
Cut out size	Housing dependant
Bathroom zone	Housing dependant
Construction material	Aluminium
Weight	200g
Maximum ambient temperature	35°C
Electric class (1, 2, 3)	3

PHOTOMETRICS @ 25°C

Product code	Colour	Beam angle	lm	lm/W	lx at 1m
LL090RGBW	White	25°	253	77	1099
	Red	25°	140	58	292
	Green	25°	275	83	831
	Blue	25°	46	14	15

WIRING INFORMATION

Cable / flying lead	2x 1m Plug & play 5-core ribbon cable
Type of wiring required	Series
PR3011	350mA power repeater, 4 RGBW channels, 350mA (for 1-6 product) (not included)
C100924	RGB & RGBW controller, 24V (not included)

LED DRIVERS



Product code	Input	SELV	Dimming	Bathroom zone	Min	Max
PS1524	220-240V	Yes	Yes	-	1	1
PS3024B	220-240V	Yes	Yes	-	1	2
PS7524	220-240V	Yes	Yes	-	1	5

ACCESSORIES

LEDRGBWEXT	Colour change plug & play 1m extension lead	Sold separately	382
RC2819 / WC2820(BLK/WH) / TR2818	4/6/8 zone RF control for RGB & RGBW system	Sold separately	376 - 377

Colour change.

01604 495 151
collingwoodlighting.com

-  @collingwoodLED
-  /collingwoodlighting
-  collingwoodled

GUARANTEE / WARRANTY

5 year extended warranty

FEATURES & BENEFITS

- MR16 for retrofit into existing housings
- Plug & play connectors for quick installation
- Short heatsink for shallow housings
- Full RGBW colour range
- Compatible with a large range of controllers



LL030CARGB

Colour change LED unit (4W max.)

FEATURES

Wattage	4W
Wattage (Red)	1W
Wattage (Green)	1.2W
Wattage (Blue)	1.2W
IP rating	IP40
Colour flexibility	RGB
Input	350mA
LED lifetime	50,000h L50 B50

INSTALLATION INFORMATION

Install Connector Type	Flying lead
Insulation Coverable	No
Cut out size	Housing dependant
Bathroom zone	Housing dependant
Construction material	Aluminium
Weight	50g
Maximum ambient temperature	35°C
Electric class (1, 2, 3)	3

PHOTOMETRICS @ 25°C

Product code	Colour	Beam angle	lm	lm/W	lx at 1m
LL030CARGB	Red	18°	38	38	319
	Green	18°	75	63	774
	Blue	18°	11	9	9

WIRING INFORMATION

Cable / flying lead	2x 1m Plug & play 4-core ribbon cable
Type of wiring required	Series
PR3011	350mA power repeater, 4 RGBW channels, 350mA (for 1-6 product) (not included)
C100924	RGB & RGBW controller, 24V (not included)

LED DRIVERS

Product code	Input	SELV	Dimming	Bathroom zone	Min	Max
PS1524	220-240V	Yes	Yes	-	1	1
PS3024B	220-240V	Yes	Yes	-	1	2
PS7524	220-240V	Yes	Yes	-	1	5

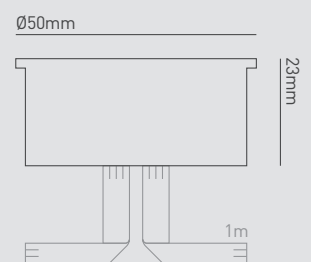

ACCESSORIES

LED 3 RGB EXT	Colour change plug & play 1m extension lead	Sold separately	383
RC2819 / WC2820(BLK/WH) / TR2818	4/6/8 zone RF control for RGB & RGBW system	Sold separately	376 - 377



Colour change.

01604 495 151
collingwoodlighting.com

 @collingwoodLED
 /collingwoodlighting
 collingwoodled

GUARANTEE / WARRANTY

5 year extended warranty

FEATURES & BENEFITS

- Low weight for mounting in ceiling voids
- Requires no fan to cool down
- Projects light down 1m & 2m lengths of fibre
- Full RGBW colour range
- Separate white LED for permanent use
- Compatible with a large range of controllers



DL329RGBW

Colour change fibre optic injector (5W max.)

FEATURES

Wattage (White)	1.1W
Wattage (Red)	1W
Wattage (Green)	1.1W
Wattage (Blue)	1.1W
IP rating	IP20
Colour flexibility	RGBW
Input	350mA
LED lifetime	50,000h L50 B50

INSTALLATION INFORMATION

Install Connector Type	Flying lead
Construction material	Aluminium
Weight	210g
Maximum ambient temperature	35°C
Electric class (1, 2, 3)	3

PHOTOMETRICS @ 25°C

Product code	Finish	Colour	CRI	lm	lm/W	lx at 1m
DL329RGBW	Black/Silver anodised	White	>80Ra	14	13	
	Black/Silver anodised	Red	>80Ra	-		
	Black/Silver anodised	Green	>80Ra	-		
	Black/Silver anodised	Blue	>80Ra	-		

WIRING INFORMATION

Cable / flying lead	2x 1m Plug & play 5-core ribbon cable
Type of wiring required	Series
PR3011	350mA power repeater, 4 RGBW channels, 350mA (for 1-6 product) (not included)
C100924	RGB & RGBW controller, 24V (not included)

LED DRIVERS

Product code	Input	SELV	Dimming	Bathroom zone	Min	Max
PS1524	220-240V	Yes	Yes	-	1	1
PS3024B	220-240V	Yes	Yes	-	1	2
PS7524	220-240V	Yes	Yes	-	1	5

ACCESSORIES

LEDRGBWEXT	Colour change plug & play 1m extension lead	Sold separately	382
FIBRE LED 1/30	Fibre optics 1m	Sold separately	127
FIBRE LED 2/30	Fibre optics 2m	Sold separately	127
RC2819 / WC2820(BLK/WH) / TR2818	4/6/8 zone RF control for RGB & RGBW system	Sold separately	376 - 377

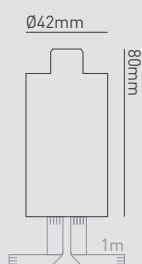



GL008RGBW

Twin drive over, colour change LED ground light (25W max.)

FEATURES

Wattage (White)	6.6W
Wattage (Red)	4.8W
Wattage (Green)	6.6W
Wattage (Blue)	6.6W
IP rating	IP67
IK rating	IK10
Colour flexibility	RGBW
Tilttable	20°
Walk over / drive over	Drive over (15mph maximum)
Input	350mA
LED lifetime	50,000h L50 B50

INSTALLATION INFORMATION

Bathroom zone	1
Construction material	Stainless steel 304 (cover ring only) / aluminium (body)
Weight	4.1Kg
Maximum ambient temperature	35°C
Electric class (1, 2, 3)	3

PHOTOMETRICS @ 25°C

Product code	Colour	Beam angle	lm	lm/W	lx at 1m
GL008RGBW	White	25°	360	55	1701
	Red	25°	261	54	715
	Green	25°	416	63	1280
	Blue	25°	68	10	285

WIRING INFORMATION

Cable / flying lead	3m CR575RGBW (outside diameter: 7.4mm)
Type of wiring required	-
PR3011	350mA power repeater, 4 RGBW channels, 350mA (for 1-6 product) (not included)
C100924	RGB & RGBW controller, 24V (not included)

LED DRIVERS

Product code	Input	SELV	Dimming	Bathroom zone	Min	Max
PS3024B	220-240V	Yes	Yes	-	1	1
PS5024	220-240V	Yes	Yes	-	1	2
PS10024	220-240V	Yes	Yes	-	1	4

ACCESSORIES

Installation tube	Installation tube	Included	
JB7	5-pole IP68 inline connector	Sold separately	423
CR575RGBW	5-core PVC cable	Sold separately	382
RC2819 / WC2820(BLK/WH) / TR2818	4/6/8 zone RF control for RGB & RGBW system	Sold separately	376 - 377

Colour change.

01604 495 151
collingwoodlighting.com

- @collingwoodLED
- /collingwoodlighting
- collingwoodled

GUARANTEE / WARRANTY

3 year extended warranty

FEATURES & BENEFITS

- Adjustable LED fitting to $\pm 20^\circ$
- Installation tube included
- 10mm toughened glass, ideal for use in driveways
- Full RGBW colour range
- Separate white LED for permanent use
- Compatible with a large range of controllers

Beam angle: 25°

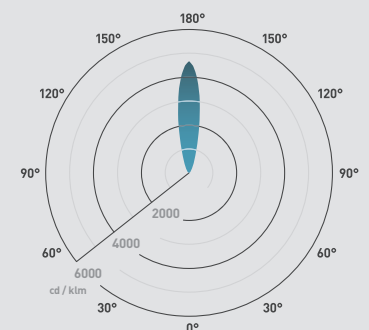

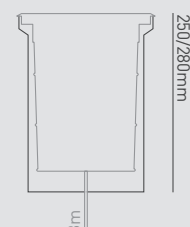

Ø225/212mm



Colour change.

01604 495 151
collingwoodlighting.com

 @collingwoodLED
 /collingwoodlighting
 collingwoodled

GUARANTEE / WARRANTY

3 year extended warranty

FEATURES & BENEFITS

Adjustable LED fitting to $\pm 20^\circ$
Installation tube included
10mm toughened glass, ideal for use in driveways
Full RGBW colour range
Separate white LED for permanent use
Compatible with a large range of controllers

Beam angle: 36°

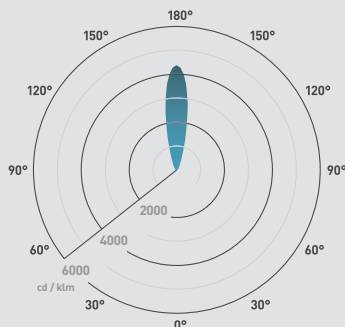

$\varnothing 185/180\text{mm}$

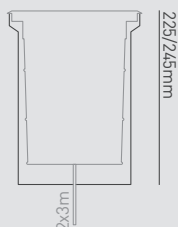

GL007RGBW

Drive over, colour change LED ground light (13W max.)

FEATURES

Wattage (White)	3.3W
Wattage (Red)	2.4W
Wattage (Green)	3.3W
Wattage (Blue)	3.3W
IP rating	IP67
IK rating	IK10
Colour flexibility	RGBW
Tilttable	20°
Walk over / drive over	Drive over (15mph maximum)
Input	350mA
LED lifetime	50,000h L50 B50

INSTALLATION INFORMATION

Bathroom zone	1
Construction material	Stainless steel 304 (cover ring only) / aluminium (body)
Weight	2.5Kg
Maximum ambient temperature	35°C
Electric class (1, 2, 3)	3

PHOTOMETRICS @ 25°C

Product code	Colour	Beam angle	lm	lm/W	lx at 1m
GL007RGBW	White	36°	180	55	782
	Red	36°	131	55	539
	Green	36°	208	63	944
	Blue	36°	34	10	15

WIRING INFORMATION

Cable / flying lead	2x 3m CR575RGBW (outside diameter: 7.4mm)
Type of wiring required	Series
PR3011	350mA power repeater, 4 RGBW channels, 350mA (for 1-6 product) (not included)
C100924	RGB & RGBW controller, 24V (not included)

LED DRIVERS

Product code	Input	SELV	Dimming	Bathroom zone	Min	Max
PS1524	220-240V	Yes	Yes	-	1	1
PS3024B	220-240V	Yes	Yes	-	1	2
PS7524	220-240V	Yes	Yes	-	1	5



ACCESSORIES

Installation tube	Installation tube	Included	
JB7	5-pole IP68 inline connector	Sold separately	423
CR575RGBW	5-core PVC cable	Sold separately	382
RC2819 / WC2820(BLK/WH) / TR2818	4/6/8 zone RF control for RGB & RGBW system	Sold separately	376 - 377



Colour change.

01604 495 151
collingwoodlighting.com

-  @collingwoodLED
-  /collingwoodlighting
-  collingwoodled

GL090RGBW

High output LED colour change ground light (12W max.)

FEATURES

Wattage (White)	3W
Wattage (Red)	2W
Wattage (Green)	3W
Wattage (Blue)	3W
IP rating	IP68
IK rating	IK08
Colour flexibility	RGBW
Walk over / drive over	Walk over (5mm toughened glass)
Input	350mA
LED lifetime	50,000h L50 B50

INSTALLATION INFORMATION

Cut out size	Ø 65mm
Bathroom zone	1
Construction material	Stainless steel (316)
Weight	900g
Maximum ambient temperature	35°C
Electric class (1, 2, 3)	3

GUARANTEE / WARRANTY

5 year extended warranty

FEATURES & BENEFITS

- High output colour change for large areas
- Marine grade stainless steel for use in outdoor and indoor environments
- Full RGBW colour range
- Separate white LED for permanent use
- Compatible with a large range of controllers

PHOTOMETRICS @ 25°C

Product code	Colour	Beam angle	lm	lm/W	lx at 1m
GL090RGBW	White	45°	177	59	173
	Red	45°	106	53	102
	Green	45°	185	62	179
	Blue	45°	43	14	42

WIRING INFORMATION

Cable / flying lead	2x 1m CR575RGBW (outside diameter: 7.4mm)
Type of wiring required	Series
PR3011	350mA power repeater, 4 RGBW channels, 350mA (for 1-6 product) (not included)
C100924	RGB & RGBW controller, 24V (not included)

LED DRIVERS

Product code	Input	SELV	Dimming	Bathroom zone	Min	Max
PS1524	220-240V	Yes	Yes	-	1	1
PS3024B	220-240V	Yes	Yes	-	1	2
PS7524	220-240V	Yes	Yes	-	1	5

ACCESSORIES

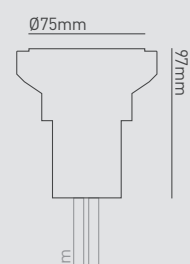
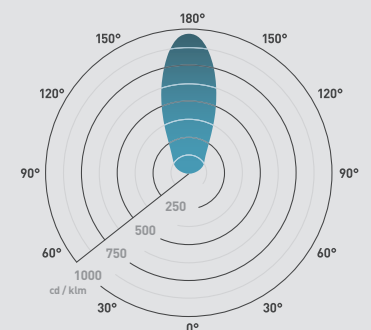

TUBE/68	Installation tube	Sold separately	236
JB7	5-pole IP68 inline connector	Sold separately	423
CR575RGBW	5-core PVC cable	Sold separately	382
RC2819 / WC2820(BLK/WH) / TR2818	4/6/8 zone RF control for RGB & RGBW system	Sold separately	376 - 377
GLA01	Ground Light Accessory, square plate, stainless steel 316,	Sold separately	237

Beam angle: 45°



Colour change.

01604 495 151
collingwoodlighting.com

 @collingwoodLED
 /collingwoodlighting
 collingwoodled

GUARANTEE / WARRANTY

5 year extended warranty

FEATURES & BENEFITS

Low profile for easy installation
Installation tube available
Full RGBW colour range
Compatible with a large range of controllers
Marine grade stainless steel for use in outdoor and indoor environments



GL040CARGB

Colour change LED ground light (3.5W max.)

FEATURES

Wattage	3.5W
Wattage (Red)	1W
Wattage (Green)	1.2W
Wattage (Blue)	1.2W
IP rating	IP68
IK rating	IK08
Colour flexibility	RGB
Walk over / drive over	Walk over (5mm toughened glass)
Input	350mA
LED lifetime	50,000h L50 B50

INSTALLATION INFORMATION

Cut out size	Ø 65mm
Bathroom zone	1
Construction material	Stainless steel (316)
Weight	800g
Maximum ambient temperature	35°C
Electric class (1, 2, 3)	3

PHOTOMETRICS @ 25°C

Product code	Colour	Beam angle	CRI	lm	lm/W	lx at 1m
GL040CARGB	Red	18°	-	34	34	287
	Green	18°	-	68	56	697
	Blue	18°	-	8	7	8

WIRING INFORMATION

Cable / flying lead	2x 1m LED RGB 0.75mm ₂ cable (outside diameter: 6mm)
Type of wiring required	Series
PR3011	350mA power repeater, 4 RGBW channels, 350mA (for 1-6 product) (not included)
C100924	RGB & RGBW controller, 24V (not included)

LED DRIVERS

Product code	Input	SELV	Dimming	Bathroom zone	Min	Max
PS1524	220-240V	Yes	Yes	-	1	1
PS3024B	220-240V	Yes	Yes	-	1	2
PS7524	220-240V	Yes	Yes	-	1	5

ACCESSORIES

TUBE/68	Installation tube	Sold separately	236
JB7	5-pole IP68 inline connector	Sold separately	423
LED RGB 0.75 CABLE	4-core PVC cable	Sold separately	383
RC2819 / WC2820(BLK/WH) / TR2818	4/6/8 zone RF control for RGB & RGBW system	Sold separately	376 - 377
GLA01	Ground Light Accessory, square plate, stainless steel 316,	Sold separately	237

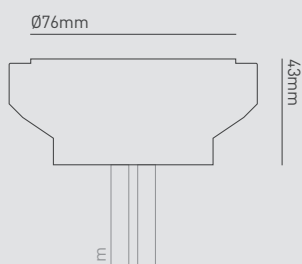

Colour change.

01604 495 151
collingwoodlighting.com

 @collingwoodLED

 /collingwoodlighting

 collingwoodled

GUARANTEE / WARRANTY

5 year extended warranty

FEATURES & BENEFITS

Installation tube available

Low profile for easy installation

Full RGBW colour range

Separate white LED for permanent use

Compatible with a large range of controllers

Marine grade stainless steel for use in outdoor and indoor environments

Beam angle: 40°

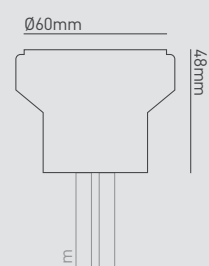
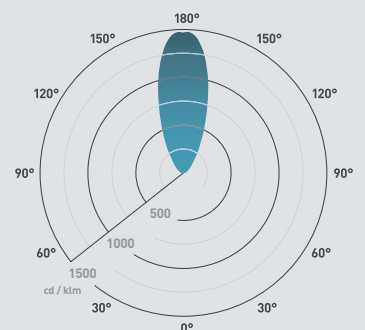

GL016RGBW

LED colour change ground light (5W max.)

FEATURES

Wattage (White)	1.2W
Wattage (Red)	1W
Wattage (Green)	1.2W
Wattage (Blue)	1.2W
IP rating	IP68
IK rating	IK09
Colour flexibility	RGBW
Walk over / drive over	Walk over (5mm toughened glass)
Input	350mA
LED lifetime	50,000h L50 B50
SDCM	3SDCM

INSTALLATION INFORMATION

Cut out size	Ø 50mm
Bathroom zone	1
Construction material	Stainless steel (316)
Weight	300g
Maximum ambient temperature	35°C
Electric class (1, 2, 3)	3

PHOTOMETRICS @ 25°C

Product code	Colour	Beam angle	lm	lm/W	lx at 1m
GL016RGBW	White	40°	50	42	74
	Red	40°	38	38	75
	Green	40°	63	53	124
	Blue	40°	11	9	17

WIRING INFORMATION

Cable / flying lead	2x 1m CR575RGBW (outside diameter: 7.4mm)
Type of wiring required	Series
PR3011	350mA power repeater, 4 RGBW channels, 350mA (for 1-6 product) (not included)
C100924	RGB & RGBW controller, 24V (not included)

LED DRIVERS



Product code	Input	SELV	Dimming	Bathroom zone	Min	Max
PS1524	220-240V	Yes	Yes	-	1	1
PS3024B	220-240V	Yes	Yes	-	1	2
PS7524	220-240V	Yes	Yes	-	1	5

ACCESSORIES

TUBE/50	Installation tube	Sold separately	236
JB7	5-pole IP68 inline connector	Sold separately	423
CR575RGBW	5-core PVC cable	Sold separately	382
RC2819 / WC2820(BLK/WH) / TR2818	4/6/8 zone RF control for RGB & RGBW system	Sold separately	376 - 377

Colour change.

01604 495 151
collingwoodlighting.com

 @collingwoodLED
 /collingwoodlighting
 collingwoodled

GUARANTEE / WARRANTY

5 year extended warranty

FEATURES & BENEFITS

- Frosted glass for subtle colour change
- Low profile for easy installation
- Full RGBW colour range
- Compatible with a large range of controllers
- Separate white LED for permanent use
- Marine grade stainless steel for use in outdoor and indoor environments

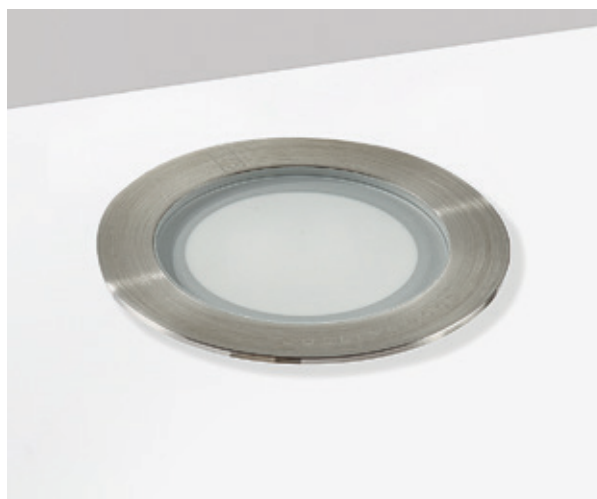

GL050RGBW

Colour change LED ground / marker light (5W max.)

FEATURES

Wattage (White)	5W
Wattage (Red)	1W
Wattage (Green)	1.2W
Wattage (Blue)	1.2W
IP rating	IP68
IK rating	IK08
Colour flexibility	RGBW
Walk over / drive over	Walk over (5mm toughened glass)
Input	350mA
LED lifetime	50,000h L50 B50

INSTALLATION INFORMATION

Cut out size	Ø 65mm
Bathroom zone	1
Construction material	Stainless steel (316)
Weight	800g
Maximum ambient temperature	35°C
Electric class (1, 2, 3)	3

PHOTOMETRICS @ 25°C

Product code	Colour	Beam angle	lm	lm/W	lx at 1m
GL050RGBW	White	100°	11	9	2
	Red	100°	9	9	2
	Green	100°	13	11	3
	Blue	100°	2	2	1

WIRING INFORMATION

Cable / flying lead	2x 1m CR575RGBW (outside diameter: 7.4mm)
Type of wiring required	Series
PR3011	350mA power repeater, 4 RGBW channels, 350mA (for 1-6 product) (not included)
C100924	RGB & RGBW controller, 24V (not included)

LED DRIVERS

Product code	Input	SELV	Dimming	Bathroom zone	Min	Max
PS1524	220-240V	Yes	Yes	-	1	1
PS3024B	220-240V	Yes	Yes	-	1	2
PS7524	220-240V	Yes	Yes	-	1	5

ACCESSORIES

TUBE/68	Installation tube	Sold separately	236
JB7	5-pole IP68 inline connector	Sold separately	423
CR575RGBW	5-core PVC cable	Sold separately	382
RC2819 / WC2820(BLK/WH) / TR2818	4/6/8 zone RF control for RGB & RGBW system	Sold separately	376 - 377

Beam angle: 100°

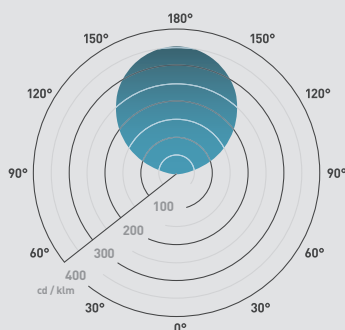

Ø76mm

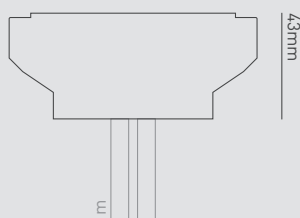



WL070RGBW

Up / down LED colour change wall light (24W max.)

FEATURES

Wattage (White)	6W
Wattage (Red)	4W
Wattage (Green)	6W
Wattage (Blue)	6W
IP rating	IP65
Colour flexibility	RGBW
Input	350mA
LED lifetime	50,000h L50 B50

INSTALLATION INFORMATION

Bathroom zone	1
Construction material	Anodised aluminium
Weight	0.9kg
Maximum ambient temperature	35°C
Electric class (1, 2, 3)	3

PHOTOMETRICS @ 25°C

Product code	Finish	Colour	Beam angle	lm	lm/W	lx at 1m
WL070RGBW	Silver	White	45°	200 / 200	67	154 / 154
	Silver	Red	45°	145 / 145	73	60 / 60
	Silver	Green	45°	230 / 230	77	168 / 168
	Silver	Blue	45°	38 / 38	13	1 / 1

WIRING INFORMATION

Cable / flying lead	1x 5-core ribbon cable
Type of wiring required	Series
PR3011	350mA power repeater, 4 RGBW channels, 350mA (for 1-6 product) (not included)
C100924	RGB & RGBW controller, 24V (not included)

LED DRIVERS

Product code	Input	SELV	Dimming	Bathroom zone	Min	Max
PS3024B	220-240V	Yes	Yes	-	1	1
PS5024	220-240V	Yes	Yes	-	1	2
PS10024	220-240V	Yes	Yes	-	1	4

ACCESSORIES

LEDRGBWEXT	Colour change plug & play 1m extension lead	Sold separately	382
RC2819 / WC2820(BLK/WH) / TR2818	4/6/8 zone RF control for RGB & RGBW system	Sold separately	376 - 377

Colour change.

01604 495 151
collingwoodlighting.com

- @collingwoodLED
- /collingwoodlighting
- collingwoodled

GUARANTEE / WARRANTY

5 year extended warranty

FEATURES & BENEFITS

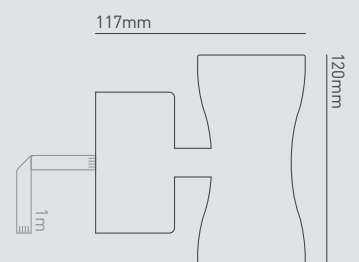
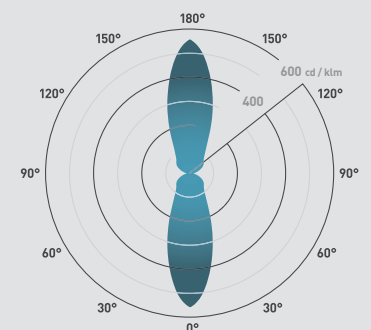

- Complete with wall fixings for easy installation
- Projects light in two directions
- Separate white LED for permanent use
- Full RGBW colour range
- Anodised aluminium for use in outdoor and indoor environments
- Compatible with a large range of controllers

Beam angle: 45°



Colour change.

01604 495 151
collingwoodlighting.com

 @collingwoodLED
 /collingwoodlighting
 collingwoodled

GUARANTEE / WARRANTY

5 year extended warranty

FEATURES & BENEFITS

- Complete with wall fixings for easy installation
- Can rotate and be angled to direct light
- Separate white LED for permanent use
- Full RGBW colour range
- Compatible with a large range of controllers
- Marine grade stainless steel for use in outdoor and indoor environments

Beam angle: 45°

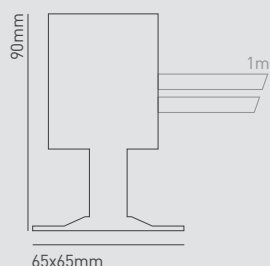
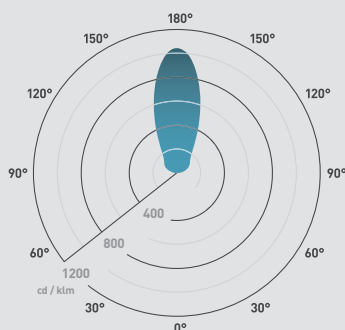

UL030RGBW

Colour change LED light (12W max.)

FEATURES

Wattage (White)	3W
Wattage (Red)	2W
Wattage (Green)	3W
Wattage (Blue)	3W
IP rating	IP68
Colour flexibility	RGBW
Tiltable	360°
Rotatable	360°
Input	350mA
LED lifetime	50,000h L50 B50

INSTALLATION INFORMATION

Bathroom zone	1
Construction material	Stainless steel (316)
Weight	900g
Maximum ambient temperature	35°C
Electric class (1, 2, 3)	3

PHOTOMETRICS @ 25°C

Product code	Colour	Beam angle	CRI	lm	lm/W	lx at 1m
UL030RGBW	White	45°	>80Ra	177	59	154
	Red	45°	>80Ra	106	53	60
	Green	45°	>80Ra	185	62	168
	Blue	45°	>80Ra	43	14	1

WIRING INFORMATION

Cable / flying lead	2x 1m CR575RGBW (outside diameter: 7.4mm)
Type of wiring required	Series
PR3011	350mA power repeater, 4 RGBW channels, 350mA (for 1-6 product) (not included)
C100924	RGB & RGBW controller, 24V (not included)

LED DRIVERS

Product code	Input	SELV	Dimming	Bathroom zone	Min	Max
PS1524	220-240V	Yes	Yes	-	1	1
PS3024B	220-240V	Yes	Yes	-	1	2
PS7524	220-240V	Yes	Yes	-	1	5

ACCESSORIES

JB7	5-pole IP68 inline connector	Sold separately	423
CR575RGBW	5-core PVC cable	Sold separately	382
RC2819 / WC2820(BLK/WH) / TR2818	4/6/8 zone RF control for RGB & RGBW system	Sold separately	376 - 377



UL010RGBW

Colour change LED light (5W max.)

FEATURES

Wattage (White)	1.1W
Wattage (Red)	1W
Wattage (Green)	1.1W
Wattage (Blue)	1.1W
IP rating	IP68
Colour flexibility	RGBW
Tilttable	360°
Rotatable	360°
Input	350mA
LED lifetime	50,000h L50 B50

INSTALLATION INFORMATION

Bathroom zone	1
Construction material	Stainless steel (316)
Weight	700g
Maximum ambient temperature	35°C
Electric class (1, 2, 3)	3

PHOTOMETRICS @ 25°C

Product code	Colour	Beam angle	CRI	lm	lm/W	lx at 1m
UL010RGBW	White	40°	>80Ra	50	45	101
	Red	40°	>80Ra	38	38	75
	Green	40°	>80Ra	63	57	124
	Blue	40°	>80Ra	11	8	17

WIRING INFORMATION

Cable / flying lead	2x 1m CR575RGBW (outside diameter: 7.4mm)
Type of wiring required	Series
PR3011	350mA power repeater, 4 RGBW channels, 350mA (for 1-6 product) (not included)
C100924	RGB & RGBW controller, 24V (not included)

LED DRIVERS

Product code	Input	SELV	Dimming	Bathroom zone	Min	Max
PS1524	220-240V	Yes	Yes	-	1	1
PS3024B	220-240V	Yes	Yes	-	1	2
PS7524	220-240V	Yes	Yes	-	1	5

ACCESSORIES

JB7	5-pole IP68 inline connector	Sold separately	423
CR575RGBW	5-core PVC cable	Sold separately	382
RC2819 / WC2820(BLK/WH) / TR2818	4/6/8 zone RF control for RGB & RGBW system	Sold separately	376 - 377

Colour change.

01604 495 151
collingwoodlighting.com

- @collingwoodLED
- /collingwoodlighting
- collingwoodled

GUARANTEE / WARRANTY

5 year extended warranty

FEATURES & BENEFITS

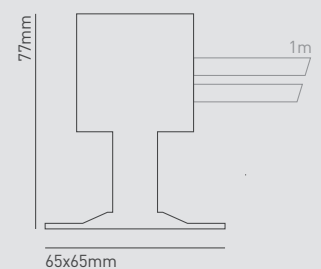
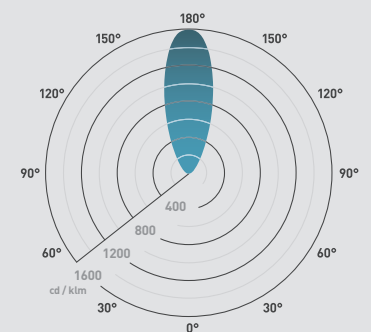

- Complete with wall fixings for easy installation
- Can rotate and be angled to direct light
- Separate white LED for permanent use
- Full RGBW colour range
- Compatible with a large range of controllers
- Marine grade stainless steel for use in outdoor and indoor environments

Beam angle: 40°



Colour change.

01604 495 151
collingwoodlighting.com

 @collingwoodLED
 /collingwoodlighting
 collingwoodled

GUARANTEE / WARRANTY

5 year extended warranty

FEATURES & BENEFITS

Surface mount in multiple applications
Full RGB colour range
Compatible with a large range of controllers
Anodised aluminium for use in outdoor and indoor environments
Removable feet can be used anywhere along the base or sides. Allen key included



UL345CARGB

110° colour change wall washing light bar (12W max.)

FEATURES

Wattage	12W
Wattage (Red)	4W
Wattage (Green)	4.1W
Wattage (Blue)	4.3W
IP rating	IP65
IK rating	IK02
Colour flexibility	RGB
Tilttable	180°
Input	Driver Required
LED lifetime	50,000h L50 B50

INSTALLATION INFORMATION

Bathroom zone	1
Construction material	Anodised aluminium
Weight	0.7kg
Maximum ambient temperature	35°C
Electric class (1, 2, 3)	3

PHOTOMETRICS @ 25°C

Product code	Finish	Colour	Beam angle	lm	lm/W	lx at 1m
UL345CARGB	Black	Red	110°	96	24	32
	Black	Green	110°	161	39	57
	Black	Blue	110°	51	12	19

WIRING INFORMATION

Cable / flying lead	1x 3m LED RGB 0.75mm ₂ cable (outside diameter: 6mm)
Type of wiring required	N/A (1 per power repeater)
PR3011	350mA power repeater, 4 RGBW channels, 350mA (for 1-6 product) (not included)
C100924	RGB & RGBW controller, 24V (not included)

LED DRIVERS

Product code	Input	SELV	Dimming	Bathroom zone	Min	Max
PS1524	220-240V	Yes	Yes	-	1	1
PS3024B	220-240V	Yes	Yes	-	1	2
PS7524	220-240V	Yes	Yes	-	1	5

ACCESSORIES

JB3	Waterproof junction box	Sold separately	422
LED RGB 0.75 CABLE	4-core PVC cable	Sold separately	383
ULBRACKET	2 piece black anodised aluminium bracket	Sold separately	277
RC2819 / WC2820(BLK/WH) / TR2818	4/6/8 zone RF control for RGB & RGBW system	Sold separately	376 - 377

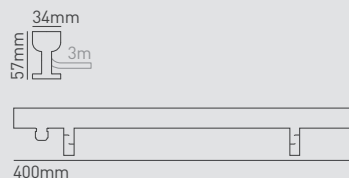

Colour change.

01604 495 151
collingwoodlighting.com

 @collingwoodLED

 /collingwoodlighting

 collingwoodled

GUARANTEE / WARRANTY

5 year extended warranty

FEATURES & BENEFITS

Surface mount in multiple applications

Full RGB colour range

Compatible with a large range of controllers

Anodised aluminium for use in outdoor and indoor environments

Removable feet can be used anywhere along the base or sides. Allen key included



UL346CARGB

25x6° colour change wall washing light bar (12W max.)

FEATURES

Wattage	12W
Wattage (Red)	4W
Wattage (Green)	4.1W
Wattage (Blue)	4.3W
IP rating	IP65
IK rating	IK02
Colour flexibility	RGB
Tilttable	180°
Input	Driver Required
LED lifetime	50,000h L50 B50

INSTALLATION INFORMATION

Bathroom zone	1
Construction material	Anodised aluminium
Weight	0.7kg
Maximum ambient temperature	35°C
Electric class [1, 2, 3]	3

PHOTOMETRICS @ 25°C

Product code	Finish	Colour	Beam angle	lm	lm/W	lx at 1m
UL346CARGB	Black	RGB	25x6°	70	18	358
	Black	RGB	25x6°	136	33	637
	Black	RGB	25x6°	23	5	96

WIRING INFORMATION

Cable / flying lead	1x 3m LED RGB 0.75mm ₂ cable (outside diameter: 6mm)
Type of wiring required	N/A (1 per power repeater)
PR3011	350mA power repeater, 4 RGBW channels, 350mA (for 1-6 product) (not included)
C100924	RGB & RGBW controller, 24V (not included)

LED DRIVERS

Product code	Input	SELV	Dimming	Bathroom zone	Min	Max
PS1524	220-240V	Yes	Yes	-	1	1
PS3024B	220-240V	Yes	Yes	-	1	2
PS7524	220-240V	Yes	Yes	-	1	5

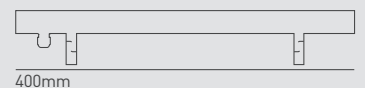

ACCESSORIES

JB3	Waterproof junction box	Sold separately	422
LED RGB 0.75 CABLE	4-core PVC cable	Sold separately	383
ULBRACKET	2 piece black anodised aluminium bracket	Sold separately	277
RC2819 / WC2820(BLK/WH) / TR2818	4/6/8 zone RF control for RGB & RGBW system	Sold separately	376 - 377



Colour change.

01604 495 151
collingwoodlighting.com

 @collingwoodLED
 /collingwoodlighting
 collingwoodled

GUARANTEE / WARRANTY

5 year extended warranty

FEATURES & BENEFITS

Surface mount in multiple applications
Full RGB colour range
Compatible with a large range of controllers
Anodised aluminium for use in outdoor and indoor environments
Removable feet can be used anywhere along the base or sides. Allen key included



UL347CARGB

45° colour change wall washing light bar (12W max.)

FEATURES

Wattage	12W
Wattage (Red)	4W
Wattage (Green)	4.1W
Wattage (Blue)	4.3W
IP rating	IP65
IK rating	IK02
Colour flexibility	RGB
Tilttable	180°
Input	Driver Required
LED lifetime	50,000h L50 B50

INSTALLATION INFORMATION

Bathroom zone	1
Construction material	Anodised aluminium
Weight	0.7kg
Maximum ambient temperature	35°C
Electric class (1, 2, 3)	3

PHOTOMETRICS @ 25°C

Product code	Finish	Colour	Beam angle	lm	lm/W	lx at 1m
UL347CARGB	Black	Red	45°	77	19	175
	Black	Green	45°	285	70	535
	Black	Blue	45°	51	12	90

WIRING INFORMATION

Cable / flying lead	1x 3m LED RGB 0.75mm ₂ cable (outside diameter: 6mm)
Type of wiring required	N/A (1 per power repeater)
PR3011	350mA power repeater, 4 RGBW channels, 350mA (for 1-6 product) (not included)
C100924	RGB & RGBW controller, 24V (not included)

LED DRIVERS

Product code	Input	SELV	Dimming	Bathroom zone	Min	Max
PS1524	220-240V	Yes	Yes	-	1	1
PS3024B	220-240V	Yes	Yes	-	1	2
PS7524	220-240V	Yes	Yes	-	1	5

ACCESSORIES

JB3	Waterproof junction box	Sold separately	422
LED RGB 0.75 CABLE	4-core PVC cable	Sold separately	383
ULBRACKET	2 piece black anodised aluminium bracket	Sold separately	277
RC2819 / WC2820(BLK/WH) / TR2818	4/6/8 zone RF control for RGB & RGBW system	Sold separately	376 - 377

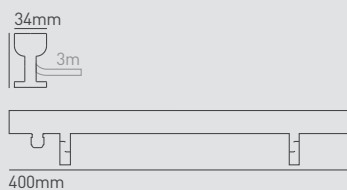

Colour change.

01604 495 151
collingwoodlighting.com

 @collingwoodLED

 /collingwoodlighting

 collingwoodled

GUARANTEE / WARRANTY

3 year extended warranty

FEATURES & BENEFITS

Cut point every 100mm

Hard-wearing clear covering

Foil backed flexible PCB dissipates heat (improves LED life and colour stability)

Full RGBW range

Separate white LED for permanent use

3M self-adhesive backing

Supplied in customised lengths (0.1m up to 4.9m in 100mm increments) 5m reel also available

Compatible with a large range of controllers

Beam angle: 120°

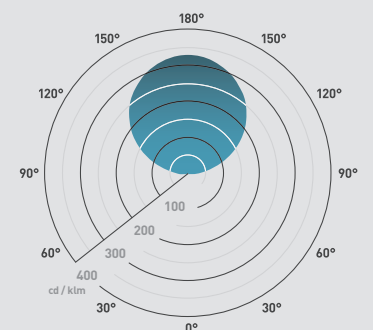

5m/100mm

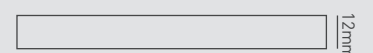

LSR05

Colour change, self-adhesive flexible strip (15W max.)

FEATURES

Maximum wattage	14.4W per metre
Wattage (White)	4.8W per metre
Wattage (Red)	4.5W per metre
Wattage (Green)	4.8W per metre
Wattage (Blue)	4.5W per metre
IP rating	IP20
Colour flexibility	RGBW
Bespoke lengths	Yes, call 01604 495 151 for more information
Self-adhesive backing	Yes
LED lifetime	25,000h

INSTALLATION INFORMATION

Construction material	Flexible tape
Weight	20g per meter
Electric class (1, 2, 3)	3

PHOTOMETRICS @ 25°C

Product code	Colour	Beam angle	CRI	lm	lm/W	lx at 1m
LSR0540050	White (4000K)	120°	>85Ra	373	70	115
	Red (4000K)	120°	>85Ra	110	33	20
	Green (4000K)	120°	>85Ra	296	90	70
	Blue (4000K)	120°	>85Ra	79	22	5
LSR0530050	White (3000K)	120°	>85Ra	350	70	115
	Red (3000K)	120°	>85Ra	130	33	20
	Green (3000K)	120°	>85Ra	270	90	70
	Blue (3000K)	120°	>85Ra	65	22	5
LSR0527050	White (2700K)	120°	>85Ra	350	70	115
	Red (2700K)	120°	>85Ra	130	33	20
	Green (2700K)	120°	>85Ra	270	90	70
	Blue (2700K)	120°	>85Ra	65	22	5

WIRING INFORMATION

Cable / flying lead	0.2m 5-core ribbon cable
Type of wiring required	Parallel
PR3011	350mA power repeater, 4 RGBW channels, 350mA (for 1-6 product) (not included)
C100924	RGB & RGBW controller, 24V (not included)

LED DRIVERS



Product code	Input	SELV	Dimming	Bathroom zone	Min	Max
PS7524	220-240V	Yes	Yes	-	1m	5m
PSIP15024	220-240V	Yes	Yes	-	1m	10m

ACCESSORIES

LED STRIP PROFILE RANGE	Profile range to house adhesive strip	Sold separately	162
CF505RGBW	5-core RGBW ribbon cable	Sold separately	382

Colour change.

01604 495 151
collingwoodlighting.com

 @collingwoodLED
 /collingwoodlighting
 collingwoodled

GUARANTEE / WARRANTY

3 year extended warranty

FEATURES & BENEFITS

5m reel
Driver included
Remote control included
IP20 making it ideal for indoor use
14.4W/m

Beam angle:

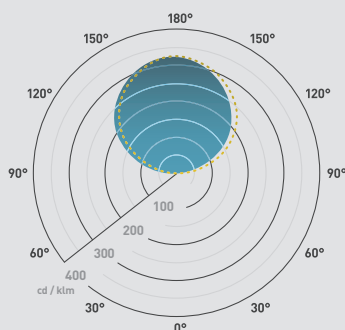

5m/100mm

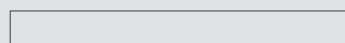

12mm

400



SPRGBW

RGBW Strip Kit, IP20, 14.4W/m, self-adhesive 5m LED strip pack with driver and remote control included

FEATURES

Maximum wattage	14.4W per metre
Wattage (White)	4.8W per metre
Wattage (Red)	4.5W per metre
Wattage (Green)	4.8W per metre
Wattage (Blue)	4.5W per metre
IP rating	IP20
Colour flexibility	RGBW
Bespoke lengths	No
Self-adhesive backing	Yes
LED lifetime	25,000h

INSTALLATION INFORMATION

Insulation Coverable	No
Inrush current	75A 0.11ms
Construction material	Copper
Maximum ambient temperature	40°C
SELV	Yes

PHOTOMETRICS @ 25°C

Product code	Colour	Beam angle	lm	lm/W	lx at 1m
SPRGBW	White	120°	373	78	124
	Red	120°	110	25	33
	Green	120°	296	62	89
	Blue	120°	79	18	24

WIRING INFORMATION

Cable / flying lead	Supplied with a minimum of 250mm fly lead with connector from one end
Type of wiring required	Parallel (mains) 220-240V AC 50/60Hz

LED DRIVERS

Product code	Input	SELV	Dimming	Bathroom zone	Min	Max
PS7524	220-240V	Yes	-	2	10cm	5m

ACCESSORIES

LED STRIP PROFILE RANGE	Profile range to house adhesive strip	Sold separately	162
PDC/GRID DIMMER	Grid dimmer kit for multiple fitting types	Sold separately	422
LED COVE PACK	Coving to house adhesive strip	Sold separately	165
PDCINT1-10V	1-10V dimming interface for use with 24V LED drivers	Sold separately	412



Lighting controls.

Our wiring and drivers selection will provide all the components required to install our products, providing both ease of installation and maintenance-free installations for many years to come. Offering both wiring and drivers for all Collingwood products, you will receive the same high-quality features and benefits as standard that are provided with our lights.

To complement our RGB and RGBW products, we also offer a range of control systems. Use them to create unique lighting zones which control separate areas with a handheld, wall mounted or smart device control (suitable for Android and iOS.) Also included in our extensive range of control devices is our range of dimmable power supplies, providing the ability to easily control the ambiance of individual zones. Available in 1-10V, DALI or mains dimming, installing Collingwood products as part of a home automation system could not be easier.

Drivers.

The ideal driver for every installation

We offer a wide range of drivers, suitable for any environment that are ideal for all Collingwood Lighting products, so you can expect the highest levels of quality and durability throughout your installation.

IP ratings

IP ratings classify the degrees of protection provided against the intrusion of solid objects and water in electrical enclosures.

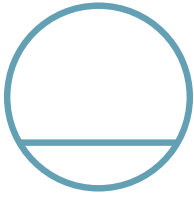

IP20

Perfect for use indoors and where there is no risk of water splashing the product.



IP64

Ideal for use indoors or outdoors, in bathrooms and other places where water may be sprayed onto the product.

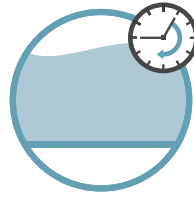

IP67

Suited for use outdoors and near water, but cannot be permanently submerged.

DIN rail

Electrical contractors use DIN rail enclosures more frequently for a neat, professional finish to a lighting installation.



Dimming options

As each installation is unique and has individual requirements, choose between mains, 1-10V or DALI dimming options.



Mains

If your product has an integrated mains dimmable driver, no separate driver is required. This is classed as a 'straight to mains' product.

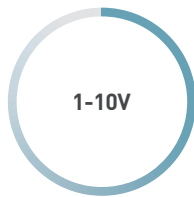

1-10V

With a 1-10V system, all the LEDs connected to the dimmer will dim at an equal amount.



DALI

A DALI system can be structured in a way which allows LEDs to respond to certain rooms or zones. Each LED in the same zone will dim an equal amount*.

Plug and play

Installing and connecting a driver is made much easier using plug and play. If you have a suitable product, use one of our plug and play drivers for straightforward installation.

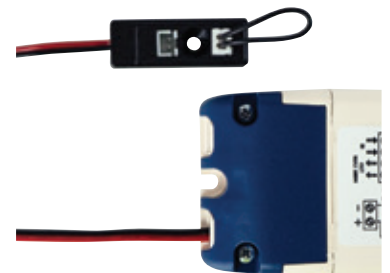

Output classification options – constant current / constant voltage

350mA

Use a 350mA driver when powering 350mA products.

700mA

Use a 700mA driver when powering 700mA products.

24mA

Use a 24v driver when powering 24v products.

Colour change.

Making controlling colour easier

Use our easy to follow step-by-step colour change control guide on pages **372-383** and follow the guide to determine what you need for your installation.

Remote controls

Offering a choice between hand held, wall mounted or app control, finding the perfect device for you couldn't be easier. Choose the ideal control for the number of zones that you want to manage. See **376-377** about zones.



WC2820WH / WC2820BLK

1-4 zones
Wall mounted control.



RC2819

1-6 zones
Handheld control.



CollingwoodRGBW App

1-8 zones
Smart device app for Android & iOS.

Controllers

This is the device used to receive a signal from your remote or DMX control system which then matches the LEDs to the colour you have selected. You will need one controller for each zone.



C100924

This eliminates the requirement for complex DMX systems. The C100924 receives the signal from the remote and matches the LEDs to the colour you have selected.



DMX2102

Using this allows our colour change system to function well with a DMX controller. The DMX2102 receives the signal from the remote and matches the LEDs to the colour you have selected.

Power repeaters

A power repeater distributes the power from the power supply to the products.



PR3011

Ideal for when using constant current products. With the ability to fit up to 100 of these to a C100924 controller, you can have as many as 600 luminaires per zone.



PR3002

Ideal solution for when using 24V products such as LED strip. With the ability to fit up to 100 of these to a C100924 controller, you can have as much as 1000m of LED strip per zone.

Products per driver matrix

The table below shows the minimum and maximum of each product that fits onto each driver.

	PSDIM180	PSMD35039	PSMD3501324	PSDAL350M	PSDIM350	PLD UNI-DRIVE 350MA	PSDIN350M	PLDCC/350/10-28 <small>*Numbers are for 24V input have the maximum for 12V input</small>	PLR/350 1-5	PLU/350 1-9	PSIP3509W <small>Available August 2020</small>	PSIP35018W <small>Available August 2020</small>	PLU/PP/350 1-9	PLU/PP4/350 1-9	PSMD700610	PSMD70024
Driver information																
Constant Current or Constant Voltage	CC	CC	CC	CC	CC	CC	CC	CC	CC	CC	CC	CC	CC	CC	CC	CC
Output classification	180mA	350mA	350mA	350mA	350mA	350mA	350mA	350mA	350mA	350mA	350mA	350mA	350mA	350mA	700mA	700mA
IP rating	IP20	IP20	IP20	IP20	IP20	IP20	IP20	IP20	IP20	IP20	IP65	IP65	IP20	IP20	IP20	IP20
Dimmable	Mains	Mains	Mains	DALI or 1-10V	1-10V	1-10V	1-10V	No	No	No	No	No	No	No	Mains	Mains
DIN rail mount	No	No	No	No	No	No	Yes	No	No	No	No	No	No	No	No	No
Plug & Play	Yes	No	No	No	No	No	No	No	No	No	No	No	Yes	Yes	No	No
Residential lighting																
Fibre LED Light Page 126		3-9	13-24	1-18	1-18	1-10	1-10	1-6*	1-5	1-9	1-8	9-17	1-9	1-9		
DL120 Page 128		3-9	13-24	1-18	1-18	1-10	1-10	1-6*	1-5	1-9	1-8	9-17	1-9	1-9		
DL130 Page 129		3-9	13-24	1-18	1-18	1-10	1-10	1-6*	1-5	1-9	1-8	9-17	1-9	1-9		
MC020 S Page 138		2-4	7-12	1-9	1-9	1-5	1-5	1-3*	1-2	1-4	1-4	5-8	1-4	1-4		
MC010 S Page 139		3-9	13-24	1-18	1-18	1-10	1-10	1-6*	1-5	1-9	1-8	9-17	1-9	1-9		
MF02 IP Page 142		3-9	13-24	1-18	1-18	1-10	1-10	1-6*	1-5	1-9	1-8	9-17	1-9	1-9		
MS02 IP Page 143		3-9	13-24	1-18	1-18	1-10	1-10	1-6*	1-5	1-9	1-8	9-17	1-9	1-9		
WL050 Page 145		3-9	13-24	1-18	1-18	1-10	1-10	1-6*	1-5	1-9	1-8	9-17	1-9	1-9		
ML01 Page 147		3-9	13-24	1-18	1-18	1-10	1-10	1-6*	1-5	1-9	1-8	9-17	1-9	1-9		
ML02 Page 148		3-9	13-24	1-18	1-18	1-10	1-10	1-6*	1-5	1-9	1-8	9-17	1-9	1-9		
ML03 Page 149		3-9	13-24	1-18	1-18	1-10	1-10	1-6*	1-5	1-9	1-8	9-17	1-9	1-9		
LED LYTE SURFACE Page 150		3-9	13-24	1-18	1-18	1-10	1-10	1-6*	1-5	1-9	1-8	9-17	1-9	1-9		
LED LYTE IP Page 151		3-9	13-24	1-18	1-18	1-10	1-10	1-6*	1-5	1-9	1-8	9-17	1-9	1-9		
LED LYTE IP T Page 152		3-9	13-24	1-18	1-18	1-10	1-10	1-6*	1-5	1-9	1-8	9-17	1-9	1-9		
LED LYTE Page 153		3-9	13-24	1-18	1-18	1-10	1-10	1-6*	1-5	1-9	1-8	9-17	1-9	1-9		
Modules that require housing																
RL111 Page 130			1	1-2	1-2	1	1					1				
DM01 Page 132															2-3	1
DM02 Page 133	1															
Commercial lighting																
RDSL Page 326																
SQSL Page 327																
RDSM Page 328															1	
SQSM Page 329															1	
RDSS Page 330			1	1-2	1-2	1	1					1				
SQSS Page 331			1	1-2	1-2	1	1					1				

Products per driver matrix

The table below shows the minimum and maximum of each product that fits onto each driver.

PSDIM180 *PSMD35039* *PSMD3501324* *PSDAL350M* *PSDIM350* *PLD UNI-DRIVE 350MA* *PSDIN350M* *PLDCC/350/10-28*
*Numbers are for 24V input, have the maximum for 12V input *PLR/350 1-5* *PLU/350 1-9* *PSIP3509W*
Available August 2020 *PSIP35018W*
Available August 2020 *PLU/PP/350 1-9* *PLU/PP-6/350 1-9* *PSMD700610* *PSMD70024*

Driver information																	
Constant Current or Constant Voltage	CC	CC	CC	CC	CC	CC	CC	CC	CC	CC	CC	CC	CC	CC	CC	CC	CC
Output classification	180mA	350mA	350mA	350mA	350mA	350mA	350mA	350mA	350mA	350mA	350mA	350mA	350mA	350mA	350mA	700mA	700mA
IP rating	IP20	IP20	IP20	IP20	IP20	IP20	IP20	IP20	IP20	IP20	IP20	IP65	IP65	IP20	IP20	IP20	IP20
Dimmable	Mains	Mains	Mains	DALI or 1-10V	1-10V	1-10V	1-10V	No	No	No	No	No	No	No	No	Mains	Mains
DIN rail mount	No	No	No	No	No	No	Yes	No	No	No	No	No	No	No	No	No	No
Plug & Play	Yes	No	No	No	No	No	No	No	No	No	No	No	No	Yes	Yes	No	No

Landscaping lighting																	
GL090 Page 208																2-3	1
GL040 Page 209		2-4	6-11	1-12	1-12	1-8	1-8	1-3*	1-3	1-4	1-4	5-8	1-4	1-4	3-5	1-2	
GL040 Ultra low glare Page 210		2-4	6-11	1-12	1-12	1-8	1-8	1-3*	1-3	1-4	1-4	5-8	1-4	1-4			
GL041 Page 211		1-3	5-8	1-6	1-6	1-3	1-3	1-2*	1	1-3	1-2	3-5	1-3	1-3	2-3	1	
GL019 Page 213		3-9	13-24	1-18	1-18	1-10	1-10	1-6*	1-5	1-9	1-8	9-17	1-9	1-9	6-10	2-4	
GL019 Ultra low glare Page 214		3-9	13-24	1-18	1-18	1-10	1-10	1-6*	1-5	1-9	1-8	9-17	1-9	1-9			
GL019LG Page 215		3-9	13-24	1-18	1-18	1-10	1-10	1-6*	1-5	1-9	1-8	9-17	1-9	1-9			
GL019 Frosted Page 216		3-9	13-24	1-18	1-18	1-10	1-10	1-6*	1-5	1-9	1-8	9-17	1-9	1-9			
GL019 SQ Page 217		3-9	13-24	1-18	1-18	1-10	1-10	1-6*	1-5	1-9	1-8	9-17	1-9	1-9	6-10	2-4	
GL019 S T Page 218		3-9	13-24	1-18	1-18	1-10	1-10	1-6*	1-5	1-9	1-8	9-17	1-9	1-9	6-10	2-4	
GL019 S TK Page 219		3-9	13-24	1-18	1-18	1-10	1-10	1-6*	1-5	1-9	1-8	9-17	1-9	1-9	6-10	2-4	
GL016 Page 220		3-9	13-24	1-18	1-18	1-10	1-10	1-6*	1-5	1-9	1-8	9-17	1-9	1-9	6-10	2-4	
GL016 SQ Page 222		3-9	13-24	1-18	1-18	1-10	1-10	1-6*	1-5	1-9	1-8	9-17	1-9	1-9	6-10	2-4	
GL016 F AB Page 221		3-9	13-24	1-18	1-18	1-10	1-10	1-6*	1-5	1-9	1-8	9-17	1-9	1-9	6-10	2-4	
GL016 Frosted Page 223		3-9	13-24	1-18	1-18	1-10	1-10	1-6*	1-5	1-9	1-8	9-17	1-9	1-9			
GL063 Page 224		1-3	5-8	1-6	1-6	1-3	1-3	1-2*	1	1-3	1-7	3-5	1-3	1-3			
GL064 Page 225		1-2	4-6	1-4	1-4	1-2	1-2	1*	1	1-2	1-2	3-4	1-2	1-2			
GL100 Page 226-227		3-9	13-24	1-18	1-18	1-10	1-10	1-6*	1-5	1-9	1-8	9-17	1-9	1-9	6-10	2-4	
GL050 Page 230		1-3	5-8	1-6	1-6	1-3	1-3	1-2*	1	1-3	1-2	3-5	1-3	1-3			
GL051 Page 231		1-3	5-8	1-6	1-6	1-3	1-3	1-2*	1	1-3	1-2	3-5	1-3	1-3			
GL018 C Page 232																	
GL018 C AB Page 233																	
GL018 SQ Page 234																	
GL018 T Page 235																	
GL021 Page 244		3-9	13-24	1-18	1-18	1-10	1-10	1-6*	1-5	1-9	1-8	9-17	1-9	1-9			
GL022 Page 245		3-9	13-24	1-18	1-18	1-10	1-10	1-6*	1-5	1-9	1-8	9-17	1-9	1-9			
OCTOLED Page 258		1-2	4-6	1-4	1-4	1-2	1-2	1*	1	1-2	1-2	3-4	1-2	1-2			
UL030 Page 264		2-4	6-11	1-12	1-12	1-8	1-8	1-3*	1-3	1-4	1-4	5-8	1-4	1-4	3-5	1-2	
UL010 Page 265															6-10	2-4	
LEDLINE 400 110 Page 268																1	
LEDLINE 400 25X6 Page 271																1	
LEDLINE 400 45 Page 274																1	

Products per driver matrix

The table below shows the minimum and maximum of each product that fits onto each driver.

	PSDIM180	PSMD35039	PSMD3501324	PSDAL350M	PSDIM350	PLD UNI-DRIVE 350MA	PSDIM350M	PLDCC/350/10-28 <small>*Numbers are for 24V input, have the maximum for 12V input</small>	PLR/350 1-5	PLU/350 1-9	PSIP3509W <small>Available August 2020</small>	PSIP35018W <small>Available August 2020</small>	PLU/PP/350 1-9	PLU/PP/350 1-9	PSMD700610	PSMD70024
Driver information																
Constant Current or Constant Voltage	CC	CC	CC	CC	CC	CC	CC	CC	CC	CC	CC	CC	CC	CC	CC	CC
Output classification	180mA	350mA	350mA	350mA	350mA	350mA	350mA	350mA	350mA	350mA	350mA	350mA	350mA	350mA	700mA	700mA
IP rating	IP20	IP20	IP20	IP20	IP20	IP20	IP20	IP20	IP20	IP20	IP65	IP65	IP20	IP20	IP20	IP20
Dimmable	Mains	Mains	Mains	DALI or 1-10V	1-10V	1-10V	1-10V	No	No	No	No	No	No	No	Mains	Mains
DIN rail mount	No	No	No	No	No	No	Yes	No	No	No	No	No	No	No	No	No
Plug & Play	Yes	No	No	No	No	No	No	No	No	No	No	No	Yes	Yes	No	No
Landscaping lighting (continued from previous page)																
SL220 Page 280		2-4	6-11	1-12	1-12	1-8	1-8	1-3*	1-3	1-4	1-4	5-8	1-4	1-4	3-5	1-2
SL030 Page 284		3-9	13-24	1-18	1-18	1-10	1-10	1-6*	1-5	1-9	1-8	9-17	1-9	1-9	6-10	2-4
SL130 Page 285		3-9	13-24	1-18	1-18	1-10	1-10	1-6*	1-5	1-9	1-8	9-17	1-9	1-9	6-10	2-4
SL040A Page 283															2-3	1
SL230 Page 288		1-2	3-5	1-6	1-6	1-4	1-4	1*	1	1-2	1-2	3-4	1-2	1-2	2-2	1
SL240 Page 286		1-2	3-5	1-6	1-6	1-4	1-4	1*	1	1-2	1-2	3-4	1-2	1-2	2-2	1
SL250 Page 290																
BOL01 Page 297		3-9	13-24	1-18	1-18	1-10	1-10	1-6*	1-5	1-9	1-8	9-17	1-9	1-9		
Strip lights																
LSV02 Page 168																
LSV05 Page 169																
LSV04 Page 170																
LSV06 Page 71																
LSV42 Page 172																
LSV45 Page 173																
LSV44 Page 174																
LSV46 Page 175																
LSV82 Page 176																
LSV85 Page 177																
LSV84 Page 178																
LSV86 Page 179																
LSC03 Page 183																
LSC43 Page 184																
LSC45 Page 185																
LSC83 Page 186																
LEDSTRIP IP Page 187																

To place an order use the driver partcodes below.

PLDM70011	PSDAL700M	PSDIN700	PLD UNI-DRIVE 700MA	PSDIN700M	PLDCC700 12-24 <small>*Numbers are for 24V input, have the maximum for 12V input.</small>	PLU/700 3-9	PSIP70018W <small>Available August 2020</small>	PSIP70036W <small>Available August 2020</small>	PSDIN900	PSDAL900M	PSMD3024	PS1524	PS3024B	PS5024	PS10024	PS7524	PSMDIP10024	PSDIP6024	PSDIP10024	PSDAL20024	PSIP15024	PSIP25024
CC	CC	CC	CC	CC	CC	CC	CC	CC	CC	CC	CV	CV	CV	CV	CV	CV	CV	CV	CV	CV	CV	CV
700mA	700mA	700mA	700mA	700mA	700mA	700mA	700mA	900mA	900mA	900mA	24V	24V	24V	24V	24V	24V	24V	24V	24V	24V	24V	24V
IP20	IP20	IP20	IP20	IP20	IP20	IP20	IP65	IP65	IP20	IP20	IP20	IP20	IP20	IP20	IP20	IP20	IP66	IP66	IP66	IP66	IP67	IP67
Mains	DALI or 1-10V	1-10V	1-10V	1-10V	No	No	No	No	1-10V	DALI	Mains	1-10V†	1-10V†	1-10V†	1-10V†	No	Mains	1-10V	1-10V	DALI	1-10V†	1-10V†
No	No	No	No	Yes	No	No	No	No	No	No	No	No	No	No	No	No	No	No	No	No	No	No
Yes	No	No	No	No	No	No	No	No	No	No	No	No	No	No	No	No	No	No	No	No	No	No

† Requires a **PDCINT1-10V** interface to make it 1 - 10V dimmable

	1-11	1-11	1-7	1-7	1-3*	1-4	1-3	4-7														
	1-18	1-18	1-10	1-10	1-6*	3-9	1-8	9-17														
	1-18	1-18	1-10	1-10	1-6*	3-9	1-8	9-17														
	1-6	1-6	1-3	1-3	1-2*	1-3	1-2	3-5														
	1-5	1-5	1-3	1-3	1*	1-2	1	2-3														
	1-5	1-5	1-3	1-3	1*	1-2	1	2-3														
											5-7	1-3	1-7	1-12	1-25	1-18	1-25	1-15	1-25	1-50	1-37	1-62

											4-6m	≤3m	≤6m	≤10m	≤20m	≤15m	≤20m	≤12m	≤20m	≤41m	≤31m	≤52m
											2-3m	≤1m	≤3m	≤5m	≤10m	≤7m	≤10m	≤6m	≤10m	≤20m	≤15m	≤26m
											2m	≤1m	≤2m	≤3m	≤6m	≤5m	≤6m	≤4m	≤6m	≤13m	≤10m	≤17m
											1m	-	≤1m	≤2m	≤5m	≤3m	≤5m	≤3m	≤5m	≤10m	≤7m	≤13m
											4-6m	≤3m	≤6m	≤10m	≤20m	≤15m	≤20m	≤12m	≤20m	≤41m	≤31m	≤52m
											2-3m	≤1m	≤3m	≤5m	≤10m	≤7m	≤10m	≤6m	≤10m	≤20m	≤15m	≤26m
											2m	≤1m	≤2m	≤3m	≤6m	≤5m	≤6m	≤4m	≤6m	≤13m	≤10m	≤17m
											1m	-	≤1m	≤2m	≤5m	≤3m	≤5m	≤3m	≤5m	≤10m	≤7m	≤13m
											4-6m	≤3m	≤6m	≤10m	≤20m	≤15m	≤20m	≤12m	≤20m	≤41m	≤31m	≤52m
											2-3m	≤1m	≤3m	≤5m	≤10m	≤7m	≤10m	≤6m	≤10m	≤20m	≤15m	≤26m
											2m	≤1m	≤2m	≤3m	≤6m	≤5m	≤6m	≤4m	≤6m	≤13m	≤10m	≤17m
											1m	-	≤1m	≤2m	≤5m	≤3m	≤5m	≤3m	≤5m	≤10m	≤7m	≤13m
											4-6m	≤3m	≤6m	≤10m	≤20m	≤15m	≤20m	≤12m	≤20m	≤41m	≤31m	≤52m
											4-6m	≤3m	≤6m	≤10m	≤20m	≤15m	≤20m	≤12m	≤20m	≤41m	≤31m	≤52m
											2m	≤1m	≤2m	≤3m	≤6m	≤5m	≤6m	≤4m	≤6m	≤13m	≤10m	≤17m
											4-6m	≤3m	≤6m	≤10m	≤20m	≤15m	≤20m	≤12m	≤20m	≤41m	≤31m	≤52m
											7-10m	≤5m	≤10m	≤17m	≤34m	≤25m	≤34m	≤20m	≤34m	≤68m	≤51m	≤86m

Products per driver matrix

Choosing the right power repeater and driver.

Colour change

For all constant current products you will need the PR3011 and for all constant voltage products you will need the PR3002.

Once you know how many products will be installed in your zone use the relevant tables to work out how many power repeaters you will need and which driver to power them.

Do this for each zone



LSR05 - Bespoke lengths available

Length of strip per power repeater	Wattage driver required	Product (driver)
Up to 2m per PR3002	50W	PS5024
Up to 5m per PR3002	100W	PS10024
Up to 10m per PR3002	150W	PSIP15024

Power repeater comparison

	CONSTANT CURRENT / CONSTANT VOLTAGE	RATED WATTAGE	INPUT CURRENT	INPUT VOLTAGE	OUTPUT CURRENT	OUTPUT VOLTAGE	AMBIENT TEMP: (TA = °C)	CASE TEMP: (TC = °C)	CONTROL
 PR3011	Constant current	4 x 8.4W max.	1.6A max.	24V DC	4 x 350mA	4 x 24V max.	40 °C	70 °C	C100924 / DMX2102
 PR3002	Constant voltage	39W channel max.	6.5A max.	24V DC	4 x 1.6A	4 x 24V	40 °C	70 °C	C100924 / DMX2102



Dimming Interface

	TYPE OF INTERFACE	RATED WATTAGE	INPUT CURRENT	INPUT VOLTAGE	OUTPUT CURRENT	OUTPUT VOLTAGE	POWER FACTOR	AMBIENT TEMP: (TA = °C)	CASE TEMP: (TC = °C)	CONTROL	DOUBLE INSULATION	EFFICIENCY	IP RATING	INRUSH CURRENT
 HAL 104	DALI	<0.05A	220-240V				0.5	-20 °C to 50 °C	65 °C	DALI broadcast dimming	Yes	80%	IP20	20A 0.4ms
 PDCINT1-10V	1-10V for 24V drivers	288W	12A max.	24V DC	12A max.	24V DC		-25 °C to 40 °C	70 °C	1-10V & DALI dimming		99%	IP20	

For full interface and power repeater specifications visit our website collingwoodlighting.com

The products will be powered by power repeaters that require a 24V driver. The table below shows which driver is needed for the number of power repeaters being used.













Products per PR3011			Products per PR3011			PR3011s per driver		
Product code		Max. per PR3011	Product code		Max. per PR3011	Number of PR3011s	Wattage driver required	Product (driver)
DL329RGBW	Page 386	6	LL090RGBW	Page 384	2	1	50W	PS5024
GL007RGBW	Page 388	2	UL010RGBW	Page 395	6	2 - 3	100W	PS10024
GL008RGBW	Page 387	1	UL030RGBW	Page 394	2	4 - 5	150W	PSIP15024
GL016RGBW	Page 391	6	UL345CARGB	Page 396	1			
GL040CARGB	Page 390	6	UL346CARGB	Page 397	1			
GL050RGBW	Page 392	6	UL347CARGB	Page 398	1			
GL090RGBW	Page 389	2	WL070RGBW	Page 393	1			
LL030CARGB	Page 385	6						

IP RATING	LOOP IN / LOOP OUT	DIN RAIL MOUNT	PROTECTION	DIMENSIONS	WEIGHT	CONNECTIONS	ACCESSORIES	WARRANTY
IP20	Yes		Short circuit & overheating	H: 28.5mm L: 170mm W: 58mm	 165g	Screw terminals < 2.5mm ² cable		5 year guarantee
IP20	Yes		Short circuit & overheating	H: 28.5mm L: 170mm W: 58mm	 165g	Screw terminals < 2.5mm ² cable		5 year guarantee

LOOP IN / LOOP OUT	DIN RAIL MOUNT	PROTECTION	SELV	DIMENSIONS (MM)	WEIGHT	CONNECTION OUTPUT	INPUT CABLE	OUTPUT CABLE	ACCESSORIES	WARRANTY
		Short circuit, overload & overheating	Yes	H: 19mm L: 115mm W: 34mm	 100g	Screw terminals 1 x 1-2.5mm ² cable				2 year guarantee
				H: 28mm L: 138mm W: 40mm	 80g	Terminals	4mm ² max.	1.5mm ² max.	Grid dimmer kit PDC/GRID DIMMER	1 year guarantee

Driver comparison.

For full driver specifications visit our website collingwoodlighting.com

	RATED WATTAGE (OUTPUT)	OUTPUT VOLTAGE	OUTPUT CURRENT	INPUT WATTAGE (MAX)	INPUT VOLTAGE	INPUT CURRENT (MAX)	INRUSH CURRENT	POWER FACTOR	AMBIENT TEMP. (TA = °C)	CONTROL	DOUBLE INSULATION	EFFICIENCY	IP RATING	PLUG & PLAY
 PSMD35039	10W	8-28V	350mA	13W	220-240V AC	0.06A	33A 0.15ms	>0.9	40 °C	Mains dimmable	Yes	75% min.	IP20	
 PSMD3501324	24W	34-68.5V	350mA	30W	220-240V AC	0.12A	20A 0.13ms	0.95	45 °C	Mains dimmable	Yes	80% min.	IP20	
 PSDAL350M	N/A (see page 406-411)	2-74V	350mA	30W	110-240V AC	0.25A	20A 0.4ms	>0.95	-25 °C to 50 °C	Push, 1-10V & DALI dimmable	Yes	90%	IP20	
 PSDIM350	N/A (see page 406-411)	2 - 74V	350mA	30W	110-240V AC	0.25A	20A 0.4ms	>0.95	-25 °C to 50 °C	Push & 1-10V dimmable	Yes	>80%	IP20	
 PLD UNI-DRIVE 350MA	N/A (see page 406-411)	2-46V	350mA	18W	110-240V AC	0.14A	5A 0.05ms	0.98	-25 °C to 50 °C	Push & 1-10V dimmable	Yes	80%	IP20	
 PSDIN350	N/A (see page 406-411)	2-46V	350mA	30W	220-240V AC	0.16A	5A 0.05ms	0.95	-25 °C to 50 °C	1-10V dimmable	Yes	88%	IP20	
 PLDCC/350/10-28	N/A (see page 406-411)	2-22V	350mA		10-28V DC				40 °C	Non-dimmable		60%	IP20	
 PLR/350 1-5	N/A (see page 406-411)	3-23V	350mA	14W	220-240V AC	0.07A	12.8A 0.6ms	0.6	40 °C	Non-dimmable	Yes	>70%	IP40	
 PLU/350 1-9	N/A (see page 406-411)	2.8-27V	350mA	25W	220-240V AC	0.14A	25.5A 0.6ms	0.55	40 °C	Non-dimmable	Yes	80%	IP40	
 PSIP3509W	N/A (see page 406-411)	2.5-25v	350mA	11W	220-240V AC	0.05A	8A 0.1ms	>0.9	50 °C	Non-dimmable	Yes	82% with full load	IP65	
 PSIP35018W	N/A (see page 406-411)	25-50v	350mA	20W	220-240V AC	0.1A	13A 0.1ms	>0.9	50 °C	Non-dimmable	Yes	83% with full load	IP65	
 PLU/PP/350 1-9	N/A (see page 406-411)	2.8-27V	350mA	25W	220-240V AC	0.14A	25.5A 0.6ms	0.55	40 °C	Non-dimmable	Yes	80%	IP40	Yes
 PLU/PP6/350 1-9	N/A (see page 406-411)	2.8-27V	350mA	25W	220-240V AC	0.14A	25.5A 0.6ms	0.55	40 °C	Non-dimmable	Yes	80%	IP40	Yes

LOOP IN / LOOP OUT	DIN RAIL MOUNT	PROTECTION	SELY	DIMENSIONS (MM)	WEIGHT	CONNECTION OUTPUT	INPUT CABLE (M)	OUTPUT CABLE	ACCESSORIES	WARRANTY
		Short circuit, overload & over current	Yes	H: 19.2mm L: 123mm W: 44.6mm		Terminals	0.5-1.5mm ²	0.5-1.5mm ²		3 year guarantee
		Short circuit, overload & over current	Yes	H: 22mm L: 155mm W: 35mm		Terminals	0.5-1.5mm ²	0.5-1.5mm ²		3 year guarantee
		Short circuit, overload & overheating	Yes	H: 22mm L: 123mm W: 79mm		Terminals	0.5-1.5mm ² max.	0.5-1.5mm ² max.	4m sync cable SYNC CABLE 4M	5 year guarantee
		Short circuit, overload & overheating	Yes	H: 22mm L: 123mm W: 79mm		Terminals	0.5-2.5mm ² max.	0.5-2.5mm ² max.	Grid dimmer kit PDC/GRID DIMMER 4m sync cable SYNC CABLE 4M	5 year guarantee
		Short circuit, overload & overheating	Yes	H: 22mm L: 103mm W: 67mm		Terminals	0.5-1.5mm ² max.	0.5-1.5mm ² max.	Grid dimmer kit PDC/GRID DIMMER 4m sync cable SYNC CABLE 4M	5 year guarantee
	Yes	Short circuit, overload & overheating	Yes	H: 36mm L: 70mm W: 90mm		Terminals	0.5-4mm ² max.	0.5-2.5mm ² max.	Grid dimmer kit PDC/GRID DIMMER 4m sync cable SYNC CABLE 4M	5 year guarantee
			Yes	H: 12mm L: 40mm W: 18mm		Flying leads	0.2	0.2		1 year guarantee
		Short circuit, overload & overheating	Yes	H: 19mm Ø: 53mm		Flying leads	0.2	0.2		1 year guarantee
Yes		Short circuit, overload & overheating	Yes	H: 28mm L: 111mm W: 48mm		Loop-in loop-out terminals	1.5mm ² max.	1.5mm ² max.	PLU weatherproof housing IX 265	1 year guarantee
		Short circuit, overload & overheating	Yes	H: 24mm L: 160mm W: 38mm		Flying leads	0.2	0.2		5 year guarantee
		Short circuit, overload & overheating	Yes	H: 25mm L: 42mm W: 180mm		Flying leads	0.2	0.2		5 year guarantee
Yes		Short circuit, overload & overheating	Yes	H: 28mm L: 111mm W: 48mm		Loop-in loop-out terminals	1.5mm ² max.	1.5mm ² max.	1m Plug & Play extension lead LED LYTE 1M EXT 6-way Plug & Play extension lead LED LYTE 6 WAY EXT	1 year guarantee
Yes		Short circuit, overload & overheating	Yes	H: 28mm L: 111mm W: 48mm		Loop-in loop-out terminals	0.5-1.5mm ² max.	0.5-1.5mm ² max.	1m Plug & Play extension lead LED LYTE 1M EXT 6-way Plug & Play extension lead LED LYTE 6 WAY EXT	1 year guarantee

Driver comparison.













For full driver specifications visit our website collingwoodlighting.com



	RATED WATTAGE (OUTPUT)	OUTPUT VOLTAGE	OUTPUT CURRENT	INPUT WATTAGE (MAX)	INPUT VOLTAGE	INPUT CURRENT (MAX)	INRUSH CURRENT	POWER FACTOR	AMBIENT TEMP. (TA = °C)	CONTROL	DOUBLE INSULATION	EFFICIENCY	IP RATING	PLUG & PLAY
 PSMD700610	24W	17-37V	700mA	30W	220-240V AC	0.12A	28A 0.16ms	0.95	45 °C	Mains dimmable	Yes	80% min.	IP20	
 PSMD70024	10W	4-14V	700mA	13W	220-240V AC	0.06A	31A 0.12ms	0.9	40 °C	Mains dimmable	Yes	75% min.	IP20	
 PLDM70011	N/A (see page 406-411)	12V	700mA	12W	220-240V AC	0.05A	15A 0.5ms	>0.95	-25 °C to 40 °C	Mains dimmable	Yes	>80%	IP20	Yes
 PSDAL700M	N/A (see page 406-411)	2-72V	700mA	56W	110-240V AC	0.25A	20A 0.4ms	>0.95	-25 °C to 50 °C	Push, 1-10V & DALI dimmable	Yes	90%	IP20	
 PSDIM700	N/A (see page 406-411)	2-72V	700mA	56W	110-240V AC	0.25A	20A 0.4ms	0.95	-25 °C to 50 °C	Push & 1-10V dimmable	Yes	80%	IP20	
 PLD UNI-DRIVE 700MA	N/A (see page 406-411)	2-46V	700mA	30W	110-240V AC	0.14A	5A 0.05ms	0.98	-25 °C to 50 °C	Push & 1-10V dimmable	Yes	80%	IP20	
 PSDIN700M	N/A (see page 406-411)	2-46V	700mA	30W	220-240V AC	0.16A	5A 0.05ms	0.95	-25 °C to 50 °C	1-10V dimmable	Yes	88%	IP20	
 PLDCC/700 12-24	N/A (see page 406-411)	2-22V	700mA		10-28V DC				40 °C	Non-dimmable		70%	IP20	
 PLU/700 3-9	N/A (see page 406-411)	8-27V	700mA	32W	220-240V AC	0.10A	14.9A 0.6ms	0.85	40 °C	Non-dimmable	Yes	80%	IP40	
 PSIP70018W	N/A (see page 406-411)	2.5-25V	700mA	20W	220-240V AC	0.1A	12A 0.1ms	>0.9	50 °C	Non-dimmable	Yes	83% with full load	IP65	
 PSIP70036W	N/A (see page 406-411)	25-50V	700mA	40W	220-240V AC	0.12A	18A 0.1ms	>0.9	50 °C	Non-dimmable	Yes	85% with full load	IP65	
 PSDIM900	N/A (see page 406-411)	2-55V	900mA	56W	110-240V AC	0.18A	20A 0.4ms	>0.95	-25 °C to 50 °C	Push & 1-10V dimmable	Yes	>80%	IP20	
 PSDAL900M	N/A (see page 406-411)	2-55V	900mA	56W	110-240V AC	0.25A	20A 0.4ms	>0.95	-25 °C to 50 °C	Push, 1-10V & DALI dimmable	Yes	>80%	IP20	

LOOP IN / LOOP OUT	DIN RAIL MOUNT	PROTECTION	SELY	DIMENSIONS (MM)	WEIGHT	CONNECTION OUTPUT	INPUT CABLE (M)	OUTPUT CABLE	ACCESSORIES	WARRANTY
		Short circuit, overload & over current	Yes	H: 22mm L: 155mm W: 35mm		Terminals	0.5-1.5mm ²	0.5-1.5mm ²		3 year guarantee
		Short circuit, overload & over current	Yes	H: 19.2mm L: 78mm W: 50mm		Terminals	0.5-1.5mm ²	0.5-1.5mm ²		3 year guarantee
		Open circuit & short circuit	Yes	H: 28mm L: 78mm W: 50mm		Plug & Play	0.15m, 0.75mm ² 2-core cable	AWG24 with Plug & Play connector		
		Short circuit, overload & overheating	Yes	H: 22mm L: 123mm W: 79mm		Terminals	0.5-2.5mm ² max.	0.5-2.5mm ² max.	Grid dimmer kit PDC/GRID DIMMER 4m sync cable SYNC CABLE 4M	5 year guarantee
		Short circuit, overload & overheating	Yes	H: 22mm L: 123mm W: 79mm		Terminals	0.5-2.5mm ² max.	0.5-2.5mm ² max.	Grid dimmer kit PDC/GRID DIMMER 4m sync cable SYNC CABLE 4M	5 year guarantee
		Short circuit, overload & overheating	Yes	H: 22mm L: 103mm W: 67mm		Terminals	0.5-1.5mm ² max.	0.5-1.5mm ² max.	Grid dimmer kit PDC/GRID DIMMER 4m sync cable SYNC CABLE 4M	5 year guarantee
	Yes	Short circuit, overload & overheating	Yes	H: 36mm L: 70mm W: 90mm		Terminals	0.5-4mm ² max.	0.5-2.5mm ² max.	Grid dimmer kit PDC/GRID DIMMER 4m sync cable SYNC CABLE 4M	5 year guarantee
			Yes	H: 18mm L: 50mm W: 32mm		Terminals	0.5-1.5mm ² max.	0.5-1.5mm ² max.		1 year guarantee
Yes		Short circuit, overload & overheating	Yes	H: 28mm L: 138mm W: 40mm		Loop-in loop-out terminals	0.5-1.5mm ² max.	0.5-1.5mm ² max.		1 year guarantee
		Short circuit, overload & overheating	Yes	H: 24mm L: 160mm W: 38mm		Flying leads	0.2	0.2		5 year guarantee
		Short circuit, overload & overheating	Yes	H: 25mm L: 180mm W: 42mm		Flying leads	0.2	0.2		5 year guarantee
		Short circuit, overload & overheating	Yes	H: 22mm L: 123mm W: 79mm		Terminals	0.5-2.5mm ² max.	0.5-2.5mm ² max.	Grid dimmer kit PDC/GRID DIMMER 4m sync cable SYNC CABLE 4M	5 year guarantee
		Short circuit, overload & overheating	Yes	H: 22mm L: 123mm W: 79mm		Terminals	0.5-2.5mm ² max.	0.5-2.5mm ² max.	Grid dimmer kit PDC/GRID DIMMER 4m sync cable SYNC CABLE 4M	5 year guarantee

Driver comparison.

For full driver specifications visit our website collingwoodlighting.com

	RATED WATTAGE (OUTPUT)	OUTPUT VOLTAGE	OUTPUT CURRENT	INPUT WATTAGE (MAX)	INPUT VOLTAGE	INPUT CURRENT (MAX)	INRUSH CURRENT	POWER FACTOR	AMBIENT TEMP. (T _A = °C)	CONTROL	DOUBLE INSULATION	EFFICIENCY	IP RATING	PLUG & PLAY
 PSMD3024	30W	24V DC	1.25A max.	36W	180-240V AC	0.17A	3A 78ms	>0.9	-20°C to 50°C	Mains Dimmable	Yes	83% with max load	IP20	
 PS1524	15W	24V DC	0.625A max.	18W	220-240V AC	0.08A	28A 0.02ms	>0.5	45°C	Dimmable with PDCINT 1-10V	Yes	>84%	IP20	
 PS3024B	30W	24V DC	1.25A max.	36W	220-240V AC	0.24A	20A 0.78ms	>0.9	-20°C to 45°C	Dimmable with PDCINT 1-10V	Yes	>80%	IP20	
 PS5024	50W	24V DC	2A max.	59W	220-240V AC	0.27A	70A 0.4ms	>0.9	-25°C to 45°C	Dimmable with PDCINT 1-10V	Yes	>85%	IP20	
 PS10024	100W	24V DC	4A max.	120W	220-240V AC	0.54A	75A 0.7ms	>0.9	-25°C to 45°C	Dimmable with PDCINT 1-10V	Yes	90%	IP20	
 PS7524	75W	24V DC	3.13A max.	90W	200-240V AC	0.4A max.	75A 0.11ms	>0.9	-20°C to 45°C	Dimmable with PDCINT 1-10V	Yes	85%	IP20	
 PSMDIP10024	100W	24V DC	4.17A	120W	180-264V AC	0.8A max.	30A 0.2ms	0.6	40°C	Mains dimmable		85% with max load	IP66	
 PSDIP6024	60W	24V DC	2.5A max.	71W	220-240V AC	0.35A	10A 0.4ms	>0.9	-25°C to 45°C	0-10V dimmable		>85%	IP66	
 PSDIP10024	100W	24V DC	4.15A max.	120W	220-240V AC	0.546A	45A 0.7ms	>0.98	-40°C to 60°C	0-10V dimmable		>80%	IP66	
 PSDAL20024	200W	24V DC	8.33A max.	240W	220-240V AC	1A	50A 0.8ms	>0.98	-25°C to 60°C	DALI dimmable		>85%	IP66	
 PSIP15024	150W	24V DC	6.3A max.	178W	220-240V AC	0.80A	45A 1ms	>0.95	-40°C to 60°C	Dimmable with PDCINT 1-10V		>85%	IP67	
 PSIP25024	250W	24V DC	10.4A max.	285W	220-240V AC	1.6A max.	30A 0.2ms	0.96	50°C	Dimmable with PDCINT 1-10V		84%	IP67	

LOOP IN / LOOP OUT	DIN RAIL MOUNT	PROTECTION	SELY	DIMENSIONS (MM)	WEIGHT	CONNECTION OUTPUT	INPUT CABLE (M)	OUTPUT CABLE	ACCESSORIES	WARRANTY
		Short circuit, overload & overcurrent	Yes	H: 35mm L: 180mm W: 60mm		Terminals	0.5-1.5mm ²	0.5-1.5mm ²		3 year guarantee
		Short circuit, overload & overheating	Yes	H: 16mm L: 103mm W: 35.5mm		Terminals	0.5-1.5mm ² max.	0.5-1.5mm ² max.	Grid dimmer kit PDC/GRID DIMMER Dimming interface PDCINT1-10V RGBW/RGB controller C100924	3 year guarantee
		Short circuit, overload & overheating	Yes	H: 30mm L: 143mm W: 45mm		Terminals	0.5-1.5mm ²	0.5-1.5mm ²	Grid dimmer kit PDC/GRID DIMMER Dimming interface PDCINT1-10V	3 year guarantee
		Short circuit, overload & overheating	Yes	H: 18mm L: 160mm W: 58mm		Terminals	0.5-1.5mm ²	0.5-1.5mm ²	Grid dimmer kit PDC/GRID DIMMER Dimming interface PDCINT1-10V RGBW/RGB controller C100924	3 year guarantee
		Short circuit, overload & overheating	Yes	H: 31mm L: 180mm W: 65.5mm		Terminals	0.5-2.5mm ²	0.5-2.5mm ²	Grid dimmer kit PDC/GRID DIMMER Dimming interface PDCINT1-10V	3 year guarantee
		Short circuit, overload, overheating & over voltage	Yes	H: 28.2mm L: 170mm W: 44.5mm		Terminals	0.5-1.5mm ² max.	0.5-1.5mm ² max.		3 year guarantee
		Short circuit, overload & over current	Yes	H: 43mm L: 230mm W: 70mm		Flying leads	0.25m, 1mm ² 3-core cable Ø: 7.5mm	0.25m, 1mm ² 2-core cable Ø: 7mm		3 year guarantee
		Short circuit, overload & overheating	Yes	H: 46mm L: 200mm W: 70mm		Flying leads	Mains: 0.25m, 1mm ² 3-core cable Ø: 7.5mm 1-10V: 0.25m, 0.75mm ² 2-core cable Ø: 6.5mm	0.25m, 1mm ² core cable Ø: 7mm	Grid dimmer kit PDC/GRID DIMMER	3 year guarantee
		Short circuit, overload & overheating	Yes	H: 44mm L: 230mm W: 68mm		Flying leads	Mains: 0.25m, 1mm ² 3-core cable Ø: 7.5mm 1-10V: 0.25m, 0.75mm ² 2-core cable Ø: 6.5mm	0.25m, 1.5mm ² 2-core cable Ø: 7mm	Grid dimmer kit PDC/GRID DIMMER	3 year guarantee
		Short circuit, overload & overheating	Yes	H: 53mm L: 255mm W: 80mm		Flying leads	Mains: 0.25m, 1mm ² 3-core cable Ø: 7.5mm DALI: 0.25m, 0.75mm ² 2-core cable Ø: 7mm	0.25m, 1.5mm ² 2-core cable Ø: 9mm		3 year guarantee
		Short circuit, overload & overheating	Yes	H: 37mm L: 190mm W: 62mm		Flying leads	0.25m, 1mm ² 3-core cable Ø: 7.5mm	0.25m, 1mm ² 2-core cable Ø: 8mm	Grid dimmer kit PDC/GRID DIMMER Dimming interface PDCINT1-10V	3 year guarantee
		Short circuit, overload & over current	Yes	H: 36mm L: 220mm W: 62mm		Flying leads	0.25m, 1mm ² 3-core cable Ø: 7.5mm	0.25m, 2mm ² 2-core cable Ø: 9mm	Grid dimmer kit PDC/GRID DIMMER Dimming interface PDCINT1-10V	3 year guarantee

Accessories.

We have an extensive range of lighting accessories to suit any requirements, and an expert team on hand to help assist in choosing the correct product for your installation. From junction boxes to grid dimmer kits, we ensure that we can equip you with the accessories needed to get the job done.

The range of IP connectors available allow any Collingwood IP rated product to be wired safely, ensuring a water-resistant circuit between the product and its power

supply. Our waterproof junction boxes have an IP rating of 68, meaning they are submersible in up to 1.3m of water. The IP rated connectors are gel filled and have the capacity to be opened and closed, enabling repeat use. Available for series, parallel and straight to mains wiring, and suitable for 2 or 3 core cables, our IP rated connectors ensure that all of our IP rated LED lights can be wired to the same high standard. If you want to know more about any of our accessory products, one of our technical experts will be more than happy to assist.



Accessories.

For accessories specific to product ranges visit the relevant sections.

JB1 (Parallel)

Waterproof junction box



Key features	
Max. voltage	30V DC
Max. current	5A
Max. conductor size	1mm ²
Cable diameter	5 - 6.5mm ²
IP rating	IP68 (2m)
Wiring	Parallel
Inputs	1
Outputs	1 - 3

Use in conjunction with	
GL018	

JB3

Waterproof junction box



Key features	
Max. voltage	400V AC
Max. current	30A
Max. conductor size	4mm ²
Cable diameter	3 - 12mm ²
IP rating	IP66
Wiring	Parallel
Inputs	1
Outputs	1 - 7

Use in conjunction with	
GL007RGBW	GL016RGBW
GL040CARGB	GL050RGBW
GL090RGBW	UL010RGBW
UL030RGBW	UL345CARGB
UL346CARGB	UL347CARGB
SL021CARGB	SL220CARGB
WL021CARGB	WL220CARGB

IX 265

PLU weatherproof housing



Key features	
IP rating	IP65
Wiring	Series
Inputs	1
Outputs	1

Use in conjunction with	
PLU350/1-9	

Dimensions
L: 173mm
W: 140mm
D: 82mm

UY2 Connector

Quick waterproof connector



Key features	
IP rating	IP65
Wiring	Series
Waterproof type	Gel
Material	Plastic

Use in conjunction with		
MF02 IP	ML01	ML02
ML03	ML010 S	ML020 S
MS02 IP	OCTOLED	

JB2 (Series)

Waterproof junction box



Key features	
Max. voltage	48V DC
Max. current	700mA
Max. conductor size	1mm ²
Cable diameter	5 - 6.5mm ²
IP rating	IP68 (2m)
Wiring	Series
Inputs	1
Outputs	1 - 3

Use in conjunction with		
BL01	GL016	GL019
GL021	GL022	GL040
GL041	GL050	GL051
GL063	GL064	GL090
UL010	UL030	SL030
SL130	SL040A	SL220
GL100		

WC 5-9

Quick release waterproof connector



Key features	
Max. voltage	250 AC / 50 DC
Max. current	10A
Max. conductor size	4mm ²
Cable diameter	5 - 9mm ²
IP rating	IP68 (1.3m)
Wiring	Inline
Inputs	1
Outputs	1

Use in conjunction with	
BL03	GL07
GL007 Frosted	GL08
GL09	GL034A
GL038A	SL220
WL339	WL340
WL341	WL342
GL200	

IX 365

PDC weatherproof housing



Key features	
IP rating	IP65
Wiring	Series / parallel
Inputs	10
Material	Plastic

Use in conjunction with	
PS1524	PS3024
PS5024	PS10024
PSDAL20024	PSDIP6024
PSDIP10024	PSIP15024

Dimensions
L: 410mm
W: 190mm
D: 110mm

PDC/Grid Dimmer

Grid dimmer kit for multiple fitting types
Requires 2-core screen cable



Constant voltage	
Dimming	1 - 10V
Min. load	1 driver
Max. load	10 drivers

Constant current	
Dimming	1 - 10V
Min. load	1 driver
Max. load	10 drivers

Use in conjunction with	
PS5024*	PS10024*
PS7524	PSIP25024
PS1524	PSDIP10024
PS3024B*	

Use in conjunction with	
PSDAL350M	PSDAL700M
PSDIN350M	PSDIN700M
PSDIM350	PSDIM700
PSDIM900	PSDAL900M

*Must be used with PDCINT 1-10V

PLD UNI-DRIVE 350MA
PLD UNI-DRIVE 700MA



Got a query? Contact our team on
+44 (0) 1604 495 151

JB4 (Series)

Gel filled waterproof junction box



Key features	
Max. voltage	120V DC
Max. current	700mA
Max. conductor size	1.5mm ²
Cable diameter	6.5 - 12mm ²
IP rating	IP68 (1.3m)
Wiring	Series
Inputs	1
Outputs	1 - 3

Use in conjunction with		
BL01	GL016	GL019
GL021	GL022	GL040
GL041	GL050	GL051
GL063	GL064	GL090
UL010	UL030	SL030
SL130	SL040A	SL220
GL100		

JB6

Inline IP68 gel filled cable connector



Key features	
Max. voltage	250V AC
Max. current	6A
Max. conductor size	0.75mm ²
Cable diameter	4.8 - 6mm ²
IP rating	IP68 (1.3m)
Wiring	Inline
Inputs	1
Outputs	1

Use in conjunction with
WCR 275 BLACK - Ideal for extending cable when it's not long enough

DMX RS 485 Cable

3-core shielded cable



Key features	
Cable	DMX RS 485 Cable
Material	Copper cable
Length	100m reel or by the metre
Indoor / outdoor	Indoor only

Use in conjunction with
DMX2102

CR135

PTFE cable



Key features	
Cable	Red or black 0.2052 PTFE
Material	PTFE
Length	100m reel

Use in conjunction with	
MC010	MC020
MF02 IP	ML01
ML02	ML03
MS02 IP	OCTOLED
UY2 CONNECTOR	

JB5 (Parallel)

Gel filled waterproof junction box



Key features	
Max. voltage	250V AC
Max. current	16A
Max. conductor size	1.5mm ²
Cable diameter	6.5 - 12mm ²
IP rating	IP68 (1.3m)
Wiring	Parallel
Inputs	1
Outputs	1 - 3

Use in conjunction with	
BL03	GL07
GL007 Frosted	GL08
GL009A	GL018
GL034A	GL038A
SL220 Mains	WL339
WL340	WL341
WL342	GL200

JB7

5 pole screw terminal IP68 connector



Key features	
Max. voltage	24V (RGBW only)
Max. current	1.4A (RGBW only)
Max. conductor size	4mm ²
Cable diameter	7 - 10.5mm ²
IP rating	IP68 (1.3m)
Wiring	Parallel
Inputs	1
Outputs	1

Use in conjunction with	
GL007RGBW	GL016RGBW
GL040CARGB	GL050RGBW
GL090RGBW	UL010RGBW
UL030RGBW	UL345CARGB
UL346CARGB	UL347CARGB
SL021CARGB	SL220CARGB
WL021CARGB	WL220CARGB

WCR 375 Black

3-core rubber cable



Key features	
Cable	H05RN-F 3 x 0.75mm ²
Material	Copper cable, rubber outer
Length	100m reel
Indoor / outdoor	Suitable for permanent outdoor use

Use in conjunction with		
JB1	JB5	WC 5-9

WCR 275 Black

2-core rubber cable



Key features	
Cable	H05RN-F 2 x 0.75mm ²
Material	Copper cable, rubber outer
Length	100m reel
Indoor / outdoor	Suitable for permanent outdoor use

Use in conjunction with	
JB1	JB2
JB4	JB6

Information.

Lighting terms.

AC (Alternating Current)

An electrical current which changes direction periodically.

Accent Lighting

Aesthetic lighting that provides emphasis, depth and decoration to draw attention to particular objects.

Ambient Temperature

Ambient temperature relates to the average air temperature in the environment surrounding the luminaire / LED driver.

Bathroom Zone

Suitability for a product to be installed near or in water.

CCT

Correlated Colour Temperature.

Colour Switchable

Colour temperature can be switched between 3000K to 4000K or 6000K / 6500K.

CRI

Colour Rendering Index.

DALI

Digital Addressable Lighting Interface. A method of digital dimming, allowing precise control of individual light fittings by an external control system.

DC (Direct Current)

An electrical current flowing in one direction only.

Dim to warm

The CCT becomes warmer as the product is dimmed.

Downlight

A luminaire designed to be installed in a ceiling, with the light source pointed vertically downwards.

Flicker

A visible constant fluctuation of light output from on to off.

IK Rating

Indicates the protection against mechanical impact. Rated from IK00 to IK10.

Insulation Coverable

Insulation can be laid directly on top of the product this can refer to rolled or blown wool insulation.

IP Rating

Ingress Protection Rating.

Kelvin (K)

Kelvin is the scientific unit for measuring CCT (Correlated Colour Temperature).

L70, B10 / L70, B50

Lifetime indication of LEDs.

LED (Light Emitting Diode)

Emits light through the conversion of electrical energy.

Lumens (lm)

The quantity of light emitted from a light source that is visible. The higher the lumens, the brighter the light.

Luminaire

Is a light fitting that contains a light source, mechanical fixings and a power supply.

Luminous Efficacy

Is a measure of energy efficiency and is calculated by dividing the lumens by the wattage (lm/W).

Luminous Flux

Total number of 'lumens' emitted from a light source.

Lux (lx)

Quantity of light that illuminates a surface, e.g. in a corridor 100 lux are required on the floor.

LUXEON Crisp white technology

This technology activates fluorescing agents in paints and fabrics to display merchandise in true colours.

mA

A milliamp is one thousandth of an amp (0.001A). Collingwood products are typically designed to take 350mA, 700mA, 900mA.

Microwave sensor

A presence sensor to reduce the amount of time lighting is left on unnecessarily.

PIR

Passive Infrared Device, used to activate lighting when a person enters a room or area.

Power supply / driver

Power source for the LED luminaire.

REACH

Registration, Evaluation, Authorisation & Restriction of Chemicals. All Collingwood products are REACH compliant.

RGB

Red, Green, Blue. Used to describe colour changing products that can be used to dynamically add colour to any environment.

RGBW

Stands for Red, Green, Blue, White. Used to describe colour changing products that can be used to dynamically add colour to any environment. Can also be run on white when natural lighting is required.

RoHS

Restriction of Hazardous Substances, an EU requirement that restricts the use of harmful materials within products. All Collingwood products are RoHS compliant.

SELV

Separated Extra Low Voltage. A low voltage power supply that will not exceed 50V AC or 120V DC.

Task lighting

Describing the installation or retrofit of LED downlights or other lighting specifically to provide functional illumination of an environment.

Thermal management

LEDs are susceptible to heat. Thermal management refers to components that are designed to remove heat efficiently to ensure high light output and long lifetime from the LEDs.

UGR

UGR stands for Unified Glare Rating. The lower the value, the more comfortable the environment.

Watt (W)

The unit of electrical power stating the amount of electricity consumed by the product.

WEEE

Waste Electrical and Electronic Equipment, Collingwood is part of a WEEE scheme. Our WEEE Registration: WEE/JC3973RV

Wiring / electrical terms.

A Extension Leads

Ready-made leads for easy extension of cables, usually with male / female plugs for Plug & Play extensions.

Flying Leads

Electrical leads already attached to the product.

H05RN-F

Electrical cable suitable for outdoor use.

Pattress Box

Back box for electrical front plates.

Plug & Play

Cables on product have 1 x male and 1 x female plugs attached for quick connection.

PTFE

A non-stick, chemically resistant insulating material.

Shielded Cable

Inner wires are wrapped in a shielding material to protect from electrical interference.

Straight to Mains

Product for which no other wiring is required other than connection to the mains supply.

Series / parallel wiring.

LED lighting products can be wired in either Series or Parallel and both have their advantages.

Series.

Series wired products that require a separate constant current driver.

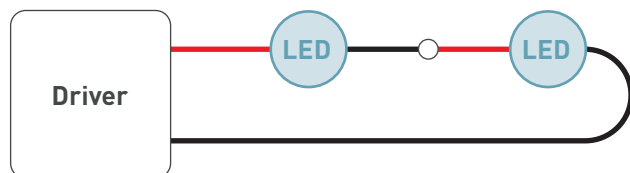

Parallel.

Parallel wired products that require a separate constant voltage driver.

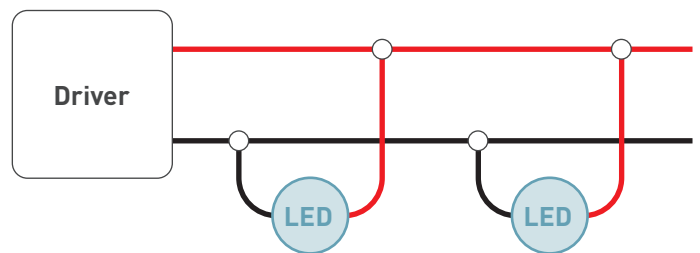

Building regulations.

Specifically related to the UK, the following building regulations should be complied with, where appropriate.

Part B - Fire Protection

When a hole is cut into a fire barrier (e.g. a fire rated ceiling), an appropriately fire-resistant luminaire must be used to block the hole from any pathway in the event of a fire in the room. All Collingwood downlights are fire rated and designed around our patented fire-resistant technology.

Part C - Moisture Protection

When a hole is cut in an insulation barrier (e.g. a ceiling tile or plaster ceiling), air and moisture can travel into the ceiling void. Part C rated downlights can assist in energy saving by preventing heat loss from a room. The H4 Pro range are the only Part C rated adjustable downlights available in the market.

Part E - Acoustic Protection

In multi-floor buildings, such as hotels and apartment blocks, sound can permeate throughout the building causing annoyance to neighbours and colleagues. With a Part E rated downlight, testing is carried out to ensure it is resistant to sound being transferred through partitions.

Part P - Electrical Safety

Covers all aspects of proper installation of electrical components. All Collingwood products have been designed to easily allow installation to Part P, but we recommend that they should be installed by a qualified electrician or a suitably competent person.

Part L - Conservation of Energy

LEDs are an energy efficient technology, however not all LED products are created equal. Part L ensures that only the most efficient products are installed, so that as little energy as possible is used, and therefore energy bills are lowered.

Since early 2014, the energy efficiency requirement in Part L is greater than 60lm/W. There is also an onus on using control systems to ensure that energy is not further wasted by lighting being left on when it is not needed.

SDCM (standard deviation colour matching).

SDCM refers to the colour consistency between light sources. SDCM is a different naming convention for MacAdam Ellipses, both terms are internationally accepted. A SDCM is a scientific term given to light sources that the human eye should not be able to distinguish a difference between in an installation.

Collingwood Lighting commits to ensuring that its illumination products have a colour consistency.

CCT (correlated colour temperature).

Choosing a colour temperature:

LEDs make it possible to have a choice of white colours or 'tones'. This allows easy customisation of an area to bring out the best in the materials and design of a room.

With standard white LED lighting, these tones range from warm-yellow to cool-blue white light, with several options in between. The graphic below is a reference that starts at a warm yellow colour on the left and fades into a cool blue colour on the right.

Collingwood Lighting uses the industry standard Correlated Colour Temperature (CCT) rating to describe the tones of white light available.

The standard unit of CCT is the kelvin (K), so CCT is described as a 'temperature'. CCT options range from 6000K / 6500K for cool white, 4000K for natural white, 3000K for warm white and 2700K for an even warmer white.

You will find colour consistency across our entire range of products ensuring seamless installations.

It can be a tricky to decide what is best for your installation, but our skilled technical sales and lighting design teams are on hand to guide you through choosing the perfect white tone for your room.

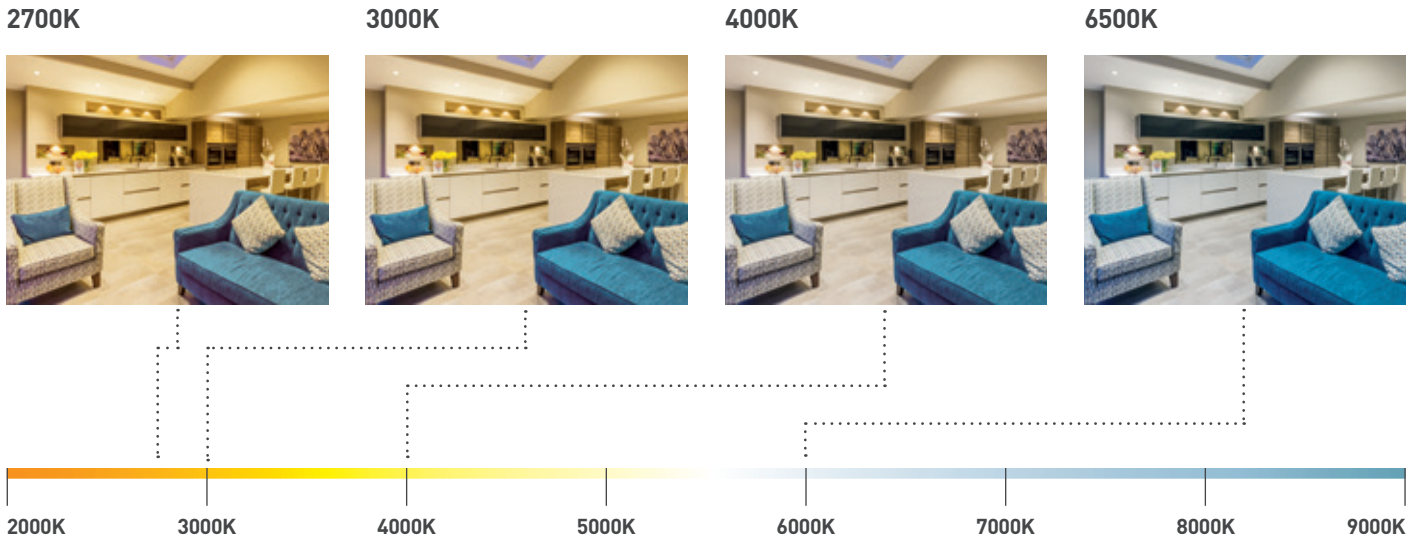

Beam angles.

- 25°** A narrow beam angle ideal for illuminating specific areas of interest with pin points of light.
- 38°** The most commonly used beam angle since the introduction of the halogen lamp in the '70s. Ideal for illuminating large areas and space between fittings is normally 1m-1.2m to create an even spread of light at floor level. Commonly used throughout residential and commercial environments.
- 45°** Can be used instead of a 38° beam angle when the ceiling is higher than standard or when looking to achieve a greater spread of light at floor and wall level. Commonly used in the hospitality market.

- 60°** This wider beam angle allows for greater spacing between fittings, up to 1.8m apart, or greater illumination at 1.2m spacings, meaning fewer luminaires are required. Also produces a more even spread of light at floor and wall level. Commonly used throughout residential and commercial environments.
- 80°** Ideal for high ceilings and illuminating large areas of space and is more commonly used in the commercial sector.

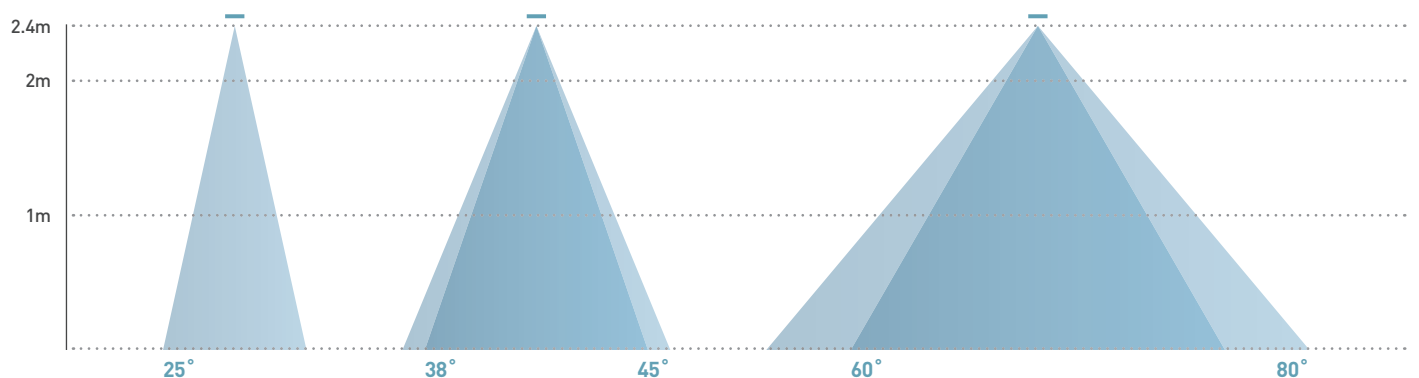

CRI (colour rendering index).

A value given to the quality of a light source with regards to how accurately it can replicate colours compared to natural daylight. CRI is given as a value out of 100, and is stated as the Rendering Index (Ra).

LEDs are generally available with a CRI of between 50Ra and 95Ra, with those in the lower end used for outdoor lighting, and those in the higher end used for professional photography.

It is generally accepted that a CRI of >70Ra is good, which is suitable for many installations, with >80Ra being very good, and more useful for general indoor lighting and >90Ra being used in specialised locations, e.g. retail or very high-end hospitality.



Low CRI



High CRI

RGB vs RGBW.

Use RGB products to select vivid red, green or blue schemes or mix the three together for even more colour options.

The addition of a white LED in RGBW products provides the option to create pastel shades and white in addition to the vivid red, green and blue colours.

RGBW can also be run on white, giving you the option of more natural lighting when it is required. Choose from 2700K, 3000K and 4000K.

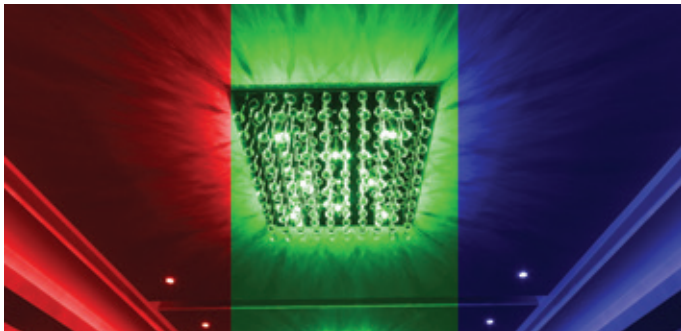

RGB

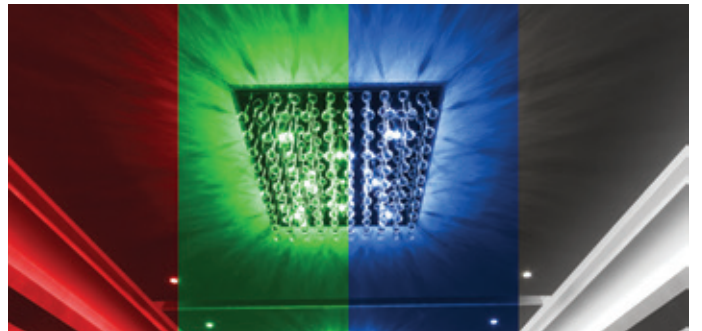

RGBW

DIALux.

Collingwood Lighting is pleased to announce that we have partnered with DIALux.

DIALux is a free 3D lighting design software which provides fast and accurate calculations and detailed, realistic visualisations of designs.

Our entire e-catalogue is available in our plug-in, giving you the freedom to select any product and add it to your virtual design. This will create an accurate representation of your lighting scheme before you get your hands dirty. Giving you the ability to get creative with your design and accomplish the perfect lighting scheme - with no regrets after installation.

To download our plug-in visit collingwoodlighting.com and click on the DIALux logo.

LED lifetime / light output.

LEDs do not use heat to generate light in the same way as commonly used lights, where 80% of the power used is dissipated as heat. This is why LEDs are referred to as cool to touch and are safer to use, especially in ground light products. However an LED does have an operating temperature within its structure. This heat, if not removed will reduce the light output and product lifetime. This is why LED products have heatsinks or use the body of the product to dissipate the heat as quickly and efficiently as possible.

Many Collingwood LED products have visible heatsinks: these are typically made from anodised aluminium and feature many thin fins. It is essential to have an air gap around the heatsink, as this ensures that heat is quickly removed, which keeps the LED at optimum temperature.

LEDs do naturally lose their ability to produce light over many thousands of hours so Collingwood Lighting publishes the expected lifetime of products within the catalogue. This helps customers to easily determine how long the product will last, and to calculate how much energy will be saved

compared to conventional incandescent lamps over the life of the product. Use the cost savings calculator on our website to see our estimate of how much our lights can save you compared to non-LEDs. Lifetime is stated as the number of hours of operation until the light level emitted from the LEDs will have dropped to a specified percentage of the original published values.

For the majority of Collingwood Lighting products, lifetime is stated as 'L70, B10 X hours'. Where, 'L70' means 70% of original light output remains. 'B10' means that 10% of products will have reached this level (i.e. 90% of products will have a light output greater than 70% of published) after 'X' number of hours of operation.

As an example, the majority of Collingwood Lighting products state lifetime as L70, B10 for 70,000 hours. However, as LEDs do naturally lose their ability to emit light, even when they have reached this point, they will continue to operate for many hundreds of hours after this level has been reached, but at an ever-reducing level.

IK rating.

Degrees of protection against external mechanical impacts.

Number	Protection	Number	Protection
IK00	Not protected.	IK06	Protected against 1 joules impact.
IK01	Protected against 0.14 joules impact.	IK07	Protected against 2 joules impact.
IK02	Protected against 0.2 joules impact.	IK08	Protected against 5 joules impact.
IK03	Protected against 0.35 joules impact.	IK09	Protected against 10 joules impact.
IK04	Protected against 0.5 joules impact.	IK10	Protected against 20 joules impact.
IK05	Protected against 0.7 joules impact.		

IP rating.

The IP rating normally has two numbers:

1. Level of protection from solid objects or materials.
2. Level of protection from liquids (water).

Solid protection.

Number	Example	Protection
0		No special protection.
1		Protection from a large part of the body such as a hand (but no protection from deliberate access); from solid objects greater than 50mm in diameter.
2		Protection against fingers or other objects not greater than 80mm in length and 12mm in diameter.
3		Protection from entry by tools, wires etc, with a diameter of 2.5mm or more.
4		Protection against solid bodies larger than 1mm.
5		Protection against dust that may harm equipment.
6		Totally dust-tight.

Liquid protection.

Number	Example	Protection
0		No special protection.
1		Protection against condensation.
2		Protection against water droplets deflected up to 15° from vertical.
3		Protection against spray up to 60° from vertical.
4		Protection against water spray from all directions.
5		Protection against low pressure water jets (all directions).
6		Protection against high pressure water jets and waves.
7		Protection against temporary immersion.
8		Protection against prolonged effects of submersion under pressure. Submersion depth to be specified.*

IP65

Ingress protection.

e.g. IP 68 @ 1bar = dust-tight and permanent protection to 1 bar pressure (9m water depth).

Bathroom / pool zones.

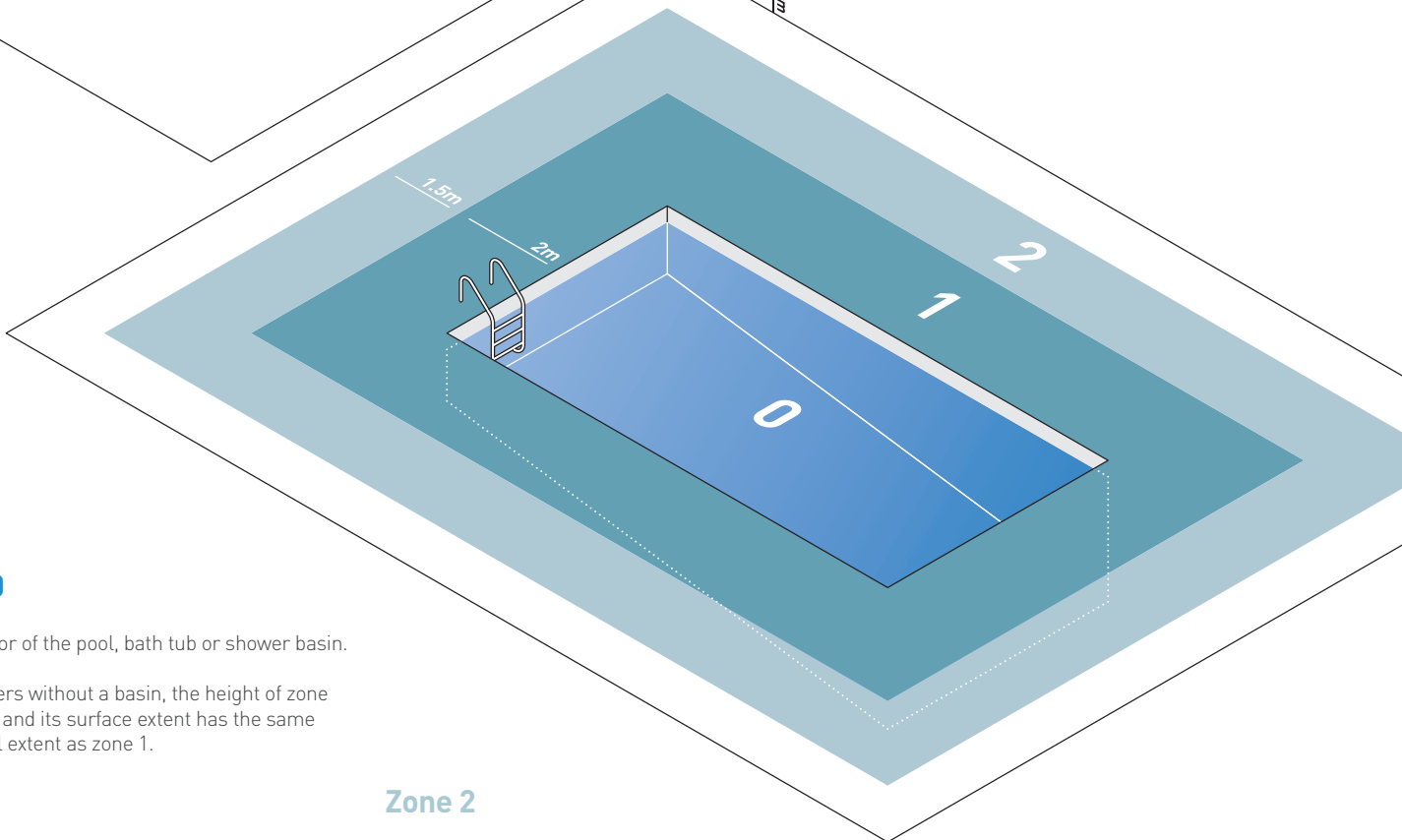
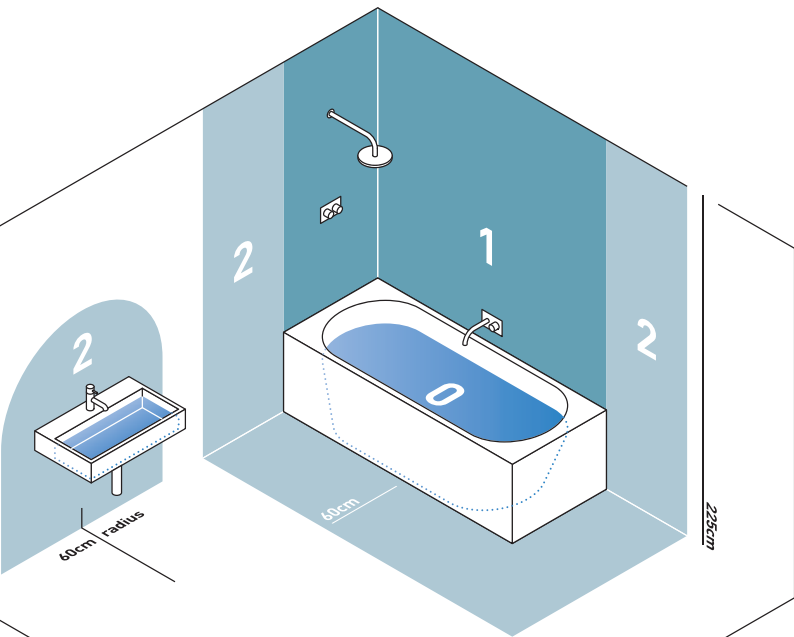

What IP rating do I need?

Zone 0 ≥IPX7

Only 12V AC rms or 30V ripple-free DC SELV, transformers must be sited outside Zones 0,1,2.

Zone 1 ≥IPX4

Only 25V AC or 60V DC ripple-free SELV. Where water jets are likely to be used for cleaning purposes in communal baths & showers at least IPX5 is required.

Zone 2 ≥IPX4

Protected by 30mA RCD. Where water jets are likely to be used for cleaning purposes in communal baths & showers at least IPX5 is required.

Outside zones 0, 1 & 2

No specific IP rating. Where water jets are likely to be used for cleaning purposes in communal baths & showers at least IPX5 is required.

Zone 0

The interior of the pool, bath tub or shower basin.

For showers without a basin, the height of zone 0 is 10cm and its surface extent has the same horizontal extent as zone 1.

Zone 1





































The three-dimensional space limited by the finished floor level and the horizontal plane corresponding to the highest fixed shower head or water outlet or the horizontal plane lying 2.25m above the finished floor level, whichever is higher and the vertical plane circumscribing the bath tub or shower.

For showers without a basin, the limiting vertical plane of zone 1 is at a distance of 1.2m from the centre point of the fixed water outlet on the wall or ceiling.









































Zone 2









































The three-dimensional space limited by the finished floor level and the horizontal plane corresponding to the highest fixed shower head or water outlet or the horizontal plane lying 2.25m above the finished floor level, whichever is higher than the vertical surface at the boundary of zone 1 and the parallel vertical surface at a distance of 60cm from the zone 1 border.

For showers without a basin, there is no zone 2 but an increased zone 1 is provided by the horizontal dimension of 1.2m.







































SMART LIGHTING				RESIDENTIAL DOWNLIGHTS							
Smart B22 Dimmable		CWSBCD	75	H2 Lite		DLT388BS5530 DLT388BS5540	83	H2 Pro 550 CS		DLT4286500 DLT4286500EM (bezels available separately)	92
Smart B22 Colour tuneable		CWSBCC	75	H2 Lite		DLT388CR5530 DLT388CR5540	83	H2 Pro 700		DLE4795527 DLE4795527EM DLE4795530 DLE4795530EM DLE4795540 DLE4795540EM (bezels available separately)	93
Smart B22 RGBW		CWSBCR	75	H2 Lite		DLT388MW5530 DLT388MW5540	83	H2 Pro Dusk		DLT2425528 DLT2425528EM (bezels available separately)	94
Smart E27 Dimmable		CWSE27D	75	H2 Lite 400 CSP		DLT4564000 (bezels available separately)	87	H2 Pro Elect		DLT4074528 DLT4074528EM DLT4074530 DLT4074530EM DLT4074540 DLT4074540EM (bezels available separately)	95
Smart E27 Colour tuneable		CWSE27C	75	H2 Lite 500		DLT469BS6030 DLT469BS6040	84	H2 Pro Elect Trimless		DL4094528 DL4094528EM DL4094530 DL4094530EM DL4094540 DL4094540EM	96
Smart E27 RGBW		CWSE27R	75	H2 Lite 500		DLT469MW6030 DLT469MW6040	84	H2 Pro Extreme		DL48938MW30 DL48938MW40	97
Smart GU10 Dimmable		CWSGU10D	75	H2 Lite 500 CSW		DLT470BS6500	85	H4 Lite		DL490BS5530 DL490BS5540	88
Smart GU10 Colour tuneable		CWSGU10C	75	H2 Lite 500 CSW		DLT470MW6500	85	H4 Lite		DL490CR5530 DL490CR5540	88
Smart GU10 RGBW		CWSGU10R	75	H2 Lite 500 CSP		DLT4566000 (bezels available separately)	86	H4 Lite		DL490MW5530 DL490MW5540	88
Smart Bridge Dimmable		CWSBRI	74	H2 Pro 550		DLE4723830 DLE4723830EM DLE4723840 DLE4723840EM DLE4727030 DLE4727030EM DLE4727040 DLE4727040EM (bezels available separately)	89	H4 Pro 550		DLE4353830 DLE4353830EM DLE4353840 DLE4353840EM DLE4357030 DLE4357030EM DLE4357040 DLE4357040EM (bezels available separately)	99
Smart Bridge Non Dimmable		CWSNBRI	75	H2 Pro 550 DALI		DLE4727030D DLE4727030DEM DLE4727040D DLE4727040DEM DLE4723830D DLE4723830DEM DLE4723840D DLE4723840DEM (bezels available separately)	90	H4 Pro 550 DALI		DLE4353830D DLE4353830DEM DLE4353840D DLE4353840DEM DLE4357030D DLE4357030DEM DLE4357040D DLE4357040DEM (bezels available separately)	99
Smart Hub		CWSHUB	74	H2 Pro 550 SPS		DLT4335530 DLT4335530EM DLT4335540 DLT4335540EM (bezels available separately)	91	H4 Pro 550 SPS		DLT4365530 DLT4365530EM DLT4365540 DLT4365540EM (bezels available separately)	101
Smart Plug		CWSPUK	74								





































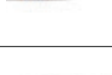

Index

RESIDENTIAL DOWNLIGHTS			RESIDENTIAL DOWNLIGHT ACCESSORIES								
H4 Pro 700		DLT4435527EM DLT4435530 DLT4435530EM DLT4435540 DLT4435540EM (bezels available separately)	102	DM298FP		DM298FP	107	H2 bezel		RB359BS (sold in multiples of two)	98
H4 Pro Elect		DLT4414528EM DLT4414530 DLT4414530EM DLT4414540 DLT4414540EM (bezels available separately)	103	DM298 GRID		DM298GRID	107	H2 bezel		RB359CR (sold in multiples of two)	98
H5 Trimless		DL282WHNWDIM DL282WHHWDIM	105	DL/ CONVERT		DL/CONVERTBLK	106	H2 bezel		RB359MW (sold in multiples of two)	98
GU10 FIRE-RATED DOWNLIGHT HOUSING				DL/ CONVERT 98		DLCONVERT98BS	106	H2 bezel		RB359PG (sold in multiples of two)	98
IP20 fixed		CWFR001	111	DL/ CONVERT 110		DLCVT110BS	106	H2 bezel		RB359SIL (sold in multiples of two)	98
IP20 fixed		CWFR002	111	DL/ CONVERT		DL/CONVERTCR	106	H2 bezel		RB359WH (sold in multiples of two)	98
IP20 fixed		CWFR003	111	DL/ CONVERT 98		DLCONVERT98CR	106	H2 bezel		SQB360BLK (sold in multiples of two)	98
IP65 fixed		CWFR004	112	DL/ CONVERT 110		DLCVT110CR	106	H2 bezel		SQB360CR (sold in multiples of two)	98
IP65 fixed		CWFR005	112	DL/ CONVERT		DLCONVERTSIL	106	H2 bezel		SQB360PG (sold in multiples of two)	98
IP65 fixed		CWFR006	112	DL/ CONVERT 98		DLCONVERT98WH	106	H2 bezel		SQB360SIL (sold in multiples of two)	98
IP20 adjustable		CWFR007	113	DL/ CONVERT 110		DLCVT110WH	106	H2 bezel		SQB360MW (sold in multiples of two)	98
IP20 adjustable		CWFR008	113	DL/ CONVERT 110		DLCVT110MW	106	H4 bezel		RB442BS (sold in multiples of two)	104
IP20 adjustable		CWFR009	113	Easy-fit connector		EFC3P (sold in multiples of twenty)	108	H4 bezel		RB442CR (sold in multiples of two)	104
				H2 bezel		RB359BLK (sold in multiples of two)	98	H4 bezel		RB442MW (sold in multiples of two)	104







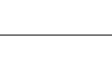





























H4 bezel		RB442WH [sold in multiples of two]	104	1901 White, fixed, square, white baffle		See page 116 for partcodes	116	1901 Double trimless, black trim, fixed, white baffle		See page 116 for partcodes	116
LEDEP06		LEDEP06	109	1901 Black, adjustable, square, black baffle		See page 116 for partcodes	116	1901 Double trimless, white trim, fixed, black baffle		See page 116 for partcodes	116
ARCHITECTURAL DOWNLIGHTS				1901 Black, adjustable, square, white baffle		See page 116 for partcodes	116	1901 Double trimless, white trim, fixed, white baffle		See page 116 for partcodes	116
1901 Black, fixed, round, black baffle		See page 116 for partcodes	116	1901 White, adjustable, square, black baffle		See page 116 for partcodes	116	1901 Double trimless, black trim, adjustable, black baffle		See page 116 for partcodes	116
1901 Black, fixed, round, white baffle		See page 116 for partcodes	116	1901 White, adjustable, square, white baffle		See page 116 for partcodes	116	1901 Double trimless, black trim, adjustable, white baffle		See page 116 for partcodes	116
1901 White, fixed, round, black baffle		See page 116 for partcodes	116	1901 Single trimless, black trim, fixed, black baffle		See page 116 for partcodes	116	1901 Double trimless, white trim, adjustable, black baffle		See page 116 for partcodes	116
1901 White, fixed, round, white baffle		See page 116 for partcodes	116	1901 Single trimless, black trim, fixed, white baffle		See page 116 for partcodes	116	1901 Double trimless, white trim, adjustable, white baffle		See page 116 for partcodes	116
1901 Black, adjustable, round, black baffle		See page 116 for partcodes	116	1901 Single trimless, white trim, fixed, black baffle		See page 116 for partcodes	116	1901 Slim, White, fixed, round, black baffle		See page 116 for partcodes	116
1901 Black, adjustable, round, white baffle		See page 116 for partcodes	116	1901 Single trimless, white trim, fixed, white baffle		See page 116 for partcodes	116	1901 Slim, White, fixed, round, white baffle		See page 116 for partcodes	116
1901 White, adjustable, round, black baffle		See page 116 for partcodes	116	1901 Single trimless, black trim, adjustable, black baffle		See page 116 for partcodes	116	DM01		DM012527 DM012540	132
1901 White, adjustable, round, white baffle		See page 116 for partcodes	116	1901 Single trimless, black trim, adjustable, white baffle		See page 116 for partcodes	116	DM02		DM022430	133
1901 Black, fixed, square, black baffle		See page 116 for partcodes	116	1901 Single trimless, white trim, adjustable, black baffle		See page 116 for partcodes	116	DL120		DL120 NW DL120 WW	128
1901 Black, fixed, square, white baffle		See page 116 for partcodes	116	1901 Single trimless, white trim, adjustable, white baffle		See page 116 for partcodes	116	DL130		DL130 NW DL130 WW	129
1901 White, fixed, square, black baffle		See page 116 for partcodes	116	1901 Double trimless, black trim, fixed, black baffle		See page 116 for partcodes	116	DL Pendant		DL PENDANT F NW DL PENDANT F WW	124

Index

ARCHITECTURAL DOWNLIGHTS			DECORATIVE WALL & UNDER SHELF LIGHTS			DECORATIVE WALL & UNDER SHELF LIGHTS ACCESSORIES		
DL Surface		DL SURFACE F NW DL SURFACE F WW 125	LED Lyte IP		LED LYTE IP 27 LED LYTE IP AMBER LED LYTE IP BLUE LED LYTE IP GREEN LED LYTE IP NW LED LYTE IP RED LED LYTE IP WW 151	LED Lyte 1M EXT		LED LYTE 1M EXT 154
Fibre LED light		FIBRE LED LIGHT NW 126	LED Lyte IP T		LED LYTE IP T 27 LED LYTE IP T BL LED LYTE IP T NW 152	LED Lyte 6WAY EXT		LED LYTE 6 WAY EXT 164
RL111		RL1112027 RL1112030 RL1112040 RL1114027 RL1114030 RL1114040 130	LED Lyte		LED LYTE 27 LED LYTE AMBER LED LYTE BLUE LED LYTE NW LED LYTE RED LED LYTE WW 153	WB/M 01		WB/M 01 144
ARCHITECTURAL DOWNLIGHTS ACCESSORIES			LED Lyte Surface		LED LYTE SURFACE 27 LED LYTE SURFACE NW LED LYTE SURFACE WW 150	WB/M 02		WB/M 02 144
AR119		AR119SIL 131	MC010		MC010 S 27 MC010 S AMBER MC010 S BLUE MC010 S GREEN MC010 S NW MC010 S RED MC010 S WW 139	WB/M 02/30 DEGREE		WB/M 02/30 DEGREE 144
AR120		AR120SIL 131	MC015		MC015 S 27 MC015 S NW MC015 S WW 140	WB/M BOX		WB/M BOX 144
AR220		AR220SIL 131	MC020		MC020 S 27 MC020 S AMBER MC020 S BLUE MC020 S GREEN MC020 S NW MC020 S RED MC020 S WW 138	WL050		WL050 NW WL050 WW 145
DH02		DH02WH 134	MC025		MC025 S 27 MC025 S NW 141	WL050 WALL BOX		WL050 WALL BOX 146
DH03		DH03WH 134	MF02 IP		MF02 IP 27 MF02 IP AMBER MF02 IP BLUE MF02 IP GREEN MF02 IP NW MF02 IP RED MF02 IP WW 142	STRIP LIGHTS		
DH04		DH04WH 134	MS02 IP		MS02 IP 27 MS02 IP AMBER MS02 IP BLUE MS02 IP GREEN MS02 IP NW MS02 IP RED MS02 IP WW 143	LEDSTRIP IP		LEDSTRIP IP AMB LEDSTRIP IP BL LEDSTRIP IP NW LEDSTRIP IP RED LEDSTRIP IP WW 187
DH05		DH05WH 134	ML01		ML01 27 ML01 AMBER ML01 BLUE ML01 GREEN ML01 NW ML01 RED ML01 WW 147	LSC03		LSC0327XXX LSC0330XXX LSC0340XXX 183
Fibre LED		FIBRE LED 1/30 FIBRE LED 2/30 127	ML02		ML02 27 ML02 AMBER ML02 BLUE ML02 GREEN ML02 NW ML02 RED ML02 WW 148	LSC43		LSC4327XXX LSC4330XXX LSC4340XXX 184
BDLFH1		BDLFH1 114	ML03		ML03 27 ML03 AMBER ML03 BLUE ML03 GREEN ML03 NW ML03 RED ML03 WW 149	LSC45		LSC4527XXX LSC4530XXX LSC4540XXX 185
LEDEP08		LEDEP08 135				LSC83		LSC8327XXX LSC8330XXX LSC8340XXX 186

LSV02		LSV0227050 LSV0230050 LSV0240050 LSV0265050	168	SP154		SP15427 SP15430 SP15435 SP15440	182	STRIP ACCESSORIES			
LSV04		LSV0427050 LSV0430050 LSV0440050 LSV0465050	170	STRIP PROFILES				ACRYLIC COVER		ACRYLIC COVER F 1M	164
LSV05		LSV0527050 LSV0530050 LSV0540050 LSV0565050	169	C07		C07010 C07020	163	C07ECA		C07ECA	163
LSV06		LSV0627050 LSV0630050 LSV0640050 LSV0665050	171	CX7		CX7010 CX7020	163	C07ECB		C07ECB	163
LSV42		LSV4227050 LSV4230050 LSV4240050 LSV4265050	172	LED COVE PACK 1M		LED COVE PACK 1M	165	C07MB		C07MB	163
LSV44		LSV4427050 LSV4430050 LSV4440050 LSV4465050	174	LINE PROFILE 20MM 1M		LINE PROFILE 20MM 1M	164	CON EXT M/F 6x12		CON EXT M/F 6x12	167
LSV45		LSV4527050 LSV4530050 LSV4540050 LSV4565050	173	PROFILE 6x12 BLK 1M		PROFILE 6x12 BLK 1M	164	CON FEMALE 7 MALE 6x12		CON FEMALE 6x12 CON MALE 6x12	167
LSV46		LSV4627050 LSV4630050 LSV4640050 LSV4665050	175	PROFILE 6x12 SIL 1M		PROFILE 6x12 SIL1M	164	CONNECTOR 6x12		CONNECTOR 6x12 CONNECTOR 6x12 5M	167
LSV82		LSV8227050 LSV8230050 LSV8240050 LSV8265050	176	RP7		RP7010 RP7020	162	CONNECTOR L 6x12		CONNECTOR L 6x12	167
LSV84		LSV8427050 LSV8430050 LSV8440050 LSV8465050	178	RP28		RP28010 RP28020	162	CONNECTOR T 6x12		CONNECTOR T 6x12	167
LSV85		LSV8527050 LSV8530050 LSV8540050 LSV8565050	177	SM7		SM7010 SM7020	162	CONNECTOR X 6x12		CONNECTOR X 6x12	167
LSV86		LSV8627050 LSV8630050 LSV8640050 LSV8665050	179	SPSIL2M		SPSIL2M	165	CX7ECA		CX7ECA	163
SP50		SP5027 SP5030 SP5040	180	U PROFILE 6x12 1M		U PROFILE 6x12 1M	164	CX7ECB		CX7ECB	163
SP54		SP5427 SP5430 SP5435 SP5440	181	SP5427		SP5427 SP5430 SP5435 SP5440	181	CX7ECC		CX7ECC	163
				SP5430				CX7ECD		CX7ECD	163

Index







STRIP ACCESSORIES								
LINE PROF END CAP		LINE PROF END CAP 164	SM7MA		SM7MA 162	GL09		GL09D24X27 GL09D38X27 GL09D60X27 GL09D24X30 GL09D38X30 GL09D60X30 GL09D24X40 GL09D38X40 GL09D60X40 204
LINE PROF FIX CLIP		LINE PROF FIX CLIP 164	RESIDENTIAL FLOODLIGHTS			GL016 frosted		GL016DC0F27 GL016DC0F30 GL016DC0F40 223
LSBFC		LSBFC8 LSBFC10 LSFC12 166	FL01		FL01BXCS FL01BPCS 192	GL016		GL016 F 27 GL016 F AMBER GL016 F BLUE GL016 F GREEN GL016 F NW GL016 F RED GL016 F WW 220
LSBFCS		LSBFCS8 LSBFCS10 LSFCS12 166	FL02		FL02BXCS FL02BPCS 193	GL016 F AB		GL016 F AB 27 GL016 F AB AMBER GL016 F AB BLUE GL016 F AB GREEN GL016 F AB NW GL016 F AB RED GL016 F AB WW 221
LSBFCD		LSBFCD8 LSBFCD10 LSFCD12 166	FL03		FL03BXCS FL03BPCS 194	GL016 square		GL016 SQ 27 GL016 SQ BLUE GL016 SQ NW GL016 SQ WW 222
LSC8PWL		LSC8PWL 167	FL05		FL05BXCS FL05BPCS 195	GL018		GL018 C 27 GL018 C AMBER GL018 C BLUE GL018 C GREEN GL018 C NW GL018 C RED GL018 C WW 232
LSC8EXT		LSC8EXT 167	FL10		FL10BXCS 196	GL018 C AB		GL018 C AB 27 GL018 C AB AMBER GL018 C AB BLUE GL018 C AB GREEN GL018 C AB NW GL018 C AB RED GL018 C AB WW 233
RP7ECA		RP7ECA 162	FL200		FL200F27 FL200FNW FL200FWW 197	GL018 square		GL018 SQ 27 GL018 SQ BLUE GL018 SQ NW GL018 SQ WW 234
RP7ECB		RP7ECB 162	GROUND LIGHTS			GL018 T		GL018 T BLUE GL018 T NW 235
SM28ECA		SM28ECA 162	GL007 frosted		GL007 FROSTED NW GL007 FROSTED WW 207	GL019		GL019 F 27 GL019 F AMBER GL019 F BLUE GL019 F GREEN GL019 F NW GL019 F RED GL019 F WW GL019 S 27 GL019 S AMBER GL019 S BLUE GL019 S GREEN GL019 S NW GL019 S RED GL019 S WW 213
SM28MB		SM28MB 162	GL07		GL07D24X27 GL07D38X27 GL07D60X27 GL07D24X30 GL07D38X30 GL07D60X30 GL07D24X40 GL07D38X40 GL07D60X40 206	GL019 frosted		GL019DC0F27 GL019DC0F30 GL019DC0F40 216
SM7ECA		SM7ECA 162	GL08		GL08D24X27 GL08D38X27 GL08D60X27 GL08D24X30 GL08D38X30 GL08D60X30 GL08D24X40 GL08D38X40 GL08D60X40 205	GL019 ultra low glare		GL019DNBL27 GL019DNBL30 GL019DNBL40 GL019DMBL27 GL019DMBL30 GL019DMBL40 214
SM7ECB		SM7ECB 162						
SM7LC		SM7LC 162						

GL019 LG		GL019LGF27 GL019LGFNW GL019LGFWW GL019LGS27 GL019LGSNW GL019LGSWW	215
GL019 square		GL019 SQ F BLUE GL019 SQ F NW GL019 SQ F WW GL019 SQ S BLUE GL019 SQ S NW	217
GL019 ST		GL019 S T 27 GL019 S T BLUE GL019 S T NW GL019 S T WW	218
GL019 S TK		GL019 S TK 27 GL019 S TK BLUE GL019 S TK NW	219
GL038 SPS		GL038DWBW27 GL038DWBW30 GL038DWBW40	212
GL040 SPS		GL040DWBX27 GL040DWBX30 GL040DWBX40 GL040DNBX27 GL040DNBX30 GL040DNBX40	209
GL040 ultra low glare		GL040DMBL27 GL040DMBL30 GL040DMBL40 GL040DNBL27 GL040DNBL30 GL040DNBL40	210
GL041		GL041 F NW GL041 F WW GL041 S NW GL041 S WW	211
GL050		GL050 27 GL050 BLUE GL050 NW GL050 WW	230
GL051		GL051 27 GL051 BLUE GL051 NW GL051 WW	231
GL063		GL063 GL06327	224
GL064		GL064 GL06427	225
GL090		GL090 F 27 GL090 F BL GL090 F NW GL090 F WW GL090 S 27 GL090 S BL GL090 S NW GL090 S WW	208













GL100 1 window		GL100DX1X27 GL100DX1X30 GL100DX1X40	226
GL100 2 windows 1 direction		GL100DX2127 GL100DX2130 GL100DX2140	226
GL100 2 windows 2 directions		GL100DX2227 GL100DX2230 GL100DX2240	226
GL100 3 windows		GL100DX3X27 GL100DX3X30 GL100DX3X40	227
GL100 4 windows		GL100DX4X27 GL100DX4X30 GL100DX4X40	227
GL200 1 window		GL200DX1X27 GL200DX1X30 GL200DX1X40	228
GL200 2 windows 1 direction		GL200DX2127 GL200DX2130 GL200DX2140	228
GL200 2 windows 2 directions		GL200DX2227 GL200DX2230 GL200DX2240	228
GL200 3 windows		GL200DX3X27 GL200DX3X30 GL200DX3X40	229
GL200 4 windows		GL200DX4X27 GL200DX4X30 GL200DX4X40	229



GROUND LIGHTS ACCESSORIES			
GLA01		GLA01	237
Installation tubes		TUBE/32 TUBE/50 TUBE/68	236











STEP LIGHTS			
GL021		GL021 27 GL021 BLUE GL021 NW GL021 WW	244
GL022		GL022 27 GL022 BLUE GL022 NW GL022 WW	245
GL034 SPS		GL034DWBW27 GL034DWBW30 GL034DWBW40	246
WL339		WL33927 WL339NW WL339WW	240
WL340		WL34027 WL340NW WL340WW	241
WL341		WL34127 WL341NW WL341WW	242
WL342		WL34227 WL342NW WL342WW	243















WALL LIGHTS			
MC040		MC040 27 MC040 NW MC040 WW	259
MC050		MC050 27 MC050 NW MC050 WW	260
OCTOLED		OCTOLED27 OCTOLEDNW OCTOLEDWW	258
WL070 SPS		WL070SNBM27 WL070SNBM30 WL070SNBM40	250
WL070 SPS		WL070BNBM27 WL070BNBM30 WL070BNBM40	250
WL070 SPS		WL070ZNBW27 WL070ZNBW30 WL070ZNBW40	250

Index

WALL LIGHTS			
WL070 SPS		WL070CNBM27 WL070CNBM30	250
WL060		WL060 27 WL060 NW WL060 WW	251
WL160		WL160 27 WL160 NW WL160 WW	251
WL075 SPS		WL075SNBM27 WL075SNBM30 WL075SNBM40	253
WL075 SPS		WL075BNBM27 WL075BNBM30 WL075BNBM40	253
WL075 SPS		WL075ZNB27 WL075ZNB30 WL075ZNB40	253
WL041 IP		WL041 IP 27 WL041 IP AMBER WL041 IP BLUE WL041 IP NW WL041 IP WW	254
WL220		WL220CWBM27	255
WL220		WL220ZWB40 WL220ZWB30 WL220ZWB27	255
WL220		WL220BWB27 WL220BWB30 WL220BWB40	255
WL220		WL220DWB27 WL220DWB30 WL220DWB40	255
WL140		WL140A F 27 WL140A F NW WL140A F WW	256
WL240		WL240A F 27 WL240A F NW WL240A F WW	257

POND LIGHTS			
UL010		UL010 27 UL010 BL UL010 NW UL010 WW	265
UL030 SPS		UL030DNBX27 UL030DNBX30 UL030DNBX40	264

UPLIGHTS			
LEDLINE 400 110		LEDLINE 400 27 110 LEDLINE 400 NW 110 LEDLINE 400 WW 110	268
LEDLINE 400 25x6		LEDLINE 400 27 25x6 LEDLINE 400 NW 25x6 LEDLINE 400 WW 25x6	271
LEDLINE 400 45		LEDLINE 400 27 45 LEDLINE 400 NW 45 LEDLINE 400 WW 45	274
ULBRACKET		ULBRACKET	277
LEDLINE MAINS 400 110		ULM345M27 ULM345M30 ULM345M40	269
LEDLINE MAINS 400 25x6		ULM346M27 ULM346M30 ULM346M40	272
LEDLINE MAINS 400 45		ULM347M27 ULM347M30 ULM347M40	275
LEDLINE MAINS 200 110		ULS345M27 ULS345M30 ULS345M40	270
LEDLINE MAINS 200 25x6		ULS346M27 ULS346M30 ULS346M40	273
LEDLINE MAINS 200 45		ULS347M27 ULS347M30 ULS347M40	276

SPIKE LIGHTS			
SL030		SL030 F 27 SL030 F AMBER SL030 F BLUE SL030 F GREEN SL030 F NW SL030 F RED SL030 F WW	284
SL040		SL040A F 27 SL040A F NW SL040A F WW SL040A S 27 SL040A S NW SL040A S WW	283
SL130		SL13027 SL13030 SL13040	285
SL130		SL130ZMBX27 SL130ZMBX30 SL130ZMBX40	285
SL220		SL220WBX27 SL220WBX40 SL220WBX30	280
SL220		SL220CWBX27	280
SL220		SL220ZWBX27 SL220ZWBX30 SL220ZWBX40	280
SL220		SL220DWBX27 SL220DWBX30 SL220DWBX40	280
SL220 Mains		SL220BWB27 SL220BWB30 SL220BWB40	281
SL220 Mains		SL220CWBM27	281
SL220 Mains		SL220ZWB27 SL220ZWB30 SL220ZWB40	281
SL220 Mains		SL220DWB27 SL220DWB30 SL220DWB40	281
SL230		SL230WBX27 SL230WBX30 SL230WBX40	288
SL230		SL230ZWBX27 SL230ZWBX30 SL230ZWBX40	288

SL230 Mains		SL230BWBXM27 SL230BWBXM30 SL230BWBXM40	289
SL230 Mains		SL230ZWBXM27 SL230ZWBXM30 SL230ZWBXM40	289
SL240		SL240BWBXM27 SL240BWBXM30 SL240BWBXM40	286
SL240		SL240ZWBXM27 SL240ZWBXM30 SL240ZWBXM40	286
SL240 Mains		SL240BWBXM27 SL240BWBXM30 SL240BWBXM40	287
SL240 Mains		SL240ZWBXM27 SL240ZWBXM30 SL240ZWBXM40	287
SL250		SL250BPXOX27 SL250BPXOX30 SL250BPXOX40	290
SL250		SL250ATXOX27 SL250ATXOX30 SL250ATXOX40	290
SL250		SL250CTXOX27	290

SPIKE LIGHTS ACCESSORIES

GH220		GH220B	282
GH220		GH220Z	282
GH220		GH220D	282
GS220		GS220B	282

GS220		GS220Z	282
GS220		GS220D	282
SL250A1		SL250A1	291

BOLLARDS

BL01 Iroko		BL01DIB27 BL01DIB30 BL01DIB40 BL01DIS27 BL01DIS30 BL01DIS40	297
BL01 Iroko		BL01FIB27 BL01FIB30 BL01FIB40 BL01FIS27 BL01FIS30 BL01FIS40	297
BL01 Iroko		BL01PIB27 BL01PIB30 BL01PIB40 BL01PIS27 BL01PIS30 BL01PIS40	297
BL01 Oak		BL01DOB27 BL01DOB30 BL01DOB40 BL01DOS27 BL01DOS30 BL01DOS40	297
BL01 Oak		BL01FOB27 BL01FOB30 BL01FOB40 BL01FOS27 BL01FOS30 BL01FOS40	297
BL01 Oak		BL01POB27 BL01POB30 BL01POB40 BL01POS27 BL01POS30 BL01POS40	297
BL01 Sapele		BL01DSB27 BL01DSB30 BL01DSB40 BL01DSS27 BL01DSS30 BL01DSS40	297
BL01 Sapele		BL01FSB27 BL01FSB30 BL01FSB40 BL01FSS27 BL01FSS30 BL01FSS40	297
BL01 Sapele		BL01PSB27 BL01PSB30 BL01PSB40 BL01PSS27 BL01PSS30 BL01PSS40	297
BL03 Iroko		BL03DIB27 BL03DIB30 BL03DIB40 BL03DIS27 BL03DIS30 BL03DIS40	296

BL03 Iroko		BL03FIB27 BL03FIB30 BL03FIB40 BL03FIS27 BL03FIS30 BL03FIS40	296
BL03 Iroko		BL03PIB27 BL03PIB30 BL03PIB40 BL03PIS27 BL03PIS30 BL03PIS40	296
BL03 Oak		BL03DOB27 BL03DOB30 BL03DOB40 BL03DOS27 BL03DOS30 BL03DOS40	296
BL03 Oak		BL03FOB27 BL03FOB30 BL03FOB40 BL03FOS27 BL03FOS30 BL03FOS40	296
BL03 Oak		BL03POB27 BL03POB30 BL03POB40 BL03POS27 BL03POS30 BL03POS40	296
BL03 Sapele		BL03DSB27 BL03DSB30 BL03DSB40 BL03DSS27 BL03DSS30 BL03DSS40	296
BL03 Sapele		BL03FSB27 BL01FSB30 BL03FSB40 BL03FSS27 BL03FSS30 BL03FSS40	296
BL03 Sapele		BL03PSB27 BL03PSB30 BL03PSB40 BL03PSS27 BL03PSS30 BL03PSS40	296





































BOLLARDS ACCESSORIES

BOL LED BRACKET		BOL LED BRACKET	298
------------------------	--	-----------------	-----

PANELS

600 x 600		P2A19S30W P2A19S40W P2A22S30W P2A22S40W P3A19D30W P3A19D40W P2A22D30W P2A22D40W P3A19V30W P3A19V40W P2A22V30W P2A22V40W	304
1200 x 600		P3C19S60W P3C19D60W P3C19V60W P2C22S60W P2C22D60W P2C22V60W	305













Index

COMMERCIAL DOWNLIGHTS ACCESSORIES		
1200 x 300		P3B19S30W P3B19D30W P3B19V30W 306
PANELS ACCESSORIES		
Solis surface mount kit		P1SMA P1SMB P1SMC 307
Solis suspension kit		P1SK P1SKC 307
COMMERCIAL DOWNLIGHTS		
Thea 12W		CDL0112M CDL0112MEM 310
Thea 16W		CDL0116M CDL0116MEM 311
Thea 24W		CDL0124M CDL0124MEM 312
Thea 32W		CDL0132M CDL0132MEM 313
COMMERCIAL DOWNLIGHTS ACCESSORIES		
DL801		DL801MW 314
LEDEP09		LEDEP09 315
RETAIL LIGHTS		
Large track		TLBLK2030 TLBLK2040 TLBLK7030 TLBLK7040 322
Large track		TLNIL2030 TLNIL2040 TLNIL7030 TLNIL7040 322
Large track		TLWH2030 TLWH2040 TLWH7030 TLWH7040 322
Medium track		TMBLK2030 TMBLK2040 TMBLK7030 TMBLK7040 323
Medium track		TMSIL2030 TMSIL2040 TMSIL7030 TMSIL7040 323
Medium track		TMWH2030 TMWH2040 TMWH7030 TMWH7040 323
Small track		TSBLK2030 TSBLK2040 TSBLK5030 TSBLK5040 324
Small track		TSSIL2030 TSSIL2040 TSSIL5030 TSSIL5040 324
Small track		TSWH2030 TSWH2040 TSWH5030 TSWH5040 324
RDSL		RDSLBLK2030 RDSLBLK2040 RDSLBLK7030 RDSLBLK7040 326
RDSL		RDSLIL2030 RDSLIL2040 RDSLIL7030 RDSLIL7040 326
RDSL		RDSLWH2030 RDSLWH2040 RDSLWH7030 RDSLWH7040 326
RDSM		RDSMBLK2030 RDSMBLK2040 RDSMBLK7030 RDSMBLK7040 328
RDSM		RDSMSIL2030 RDSMSIL2040 RDSMSIL7030 RDSMSIL7040 328
RDSM		RDSMWH2030 RDSMWH2040 RDSMWH7030 RDSMWH7040 328
RDSS		RDSSBLK2030 RDSSBLK2040 RDSSBLK5030 RDSSBLK5040 330
RDSS		RDSSIL2030 RDSSIL2040 RDSSIL5030 RDSSIL5040 330
RDSS		RDSSWH2030 RDSSWH2040 RDSSWH5030 RDSSWH5040 330
RHC		RHCL RHCM RHCS 325
SQSL		SQSLBLK2030 SQSLBLK2040 SQSLBLK7030 SQSLBLK7040 327
SQSL		SQSLIL2030 SQSLIL2040 SQSLIL7030 SQSLIL7040 327
SQSL		SQSLWH2030 SQSLWH2040 SQSLWH7030 SQSLWH7040 327
SQSM		SQSMBLK2030 SQSMBLK2040 SQSMBLK7030 SQSMBLK7040 329
SQSM		SQSMSIL2030 SQSMSIL2040 SQSMSIL7030 SQSMSIL7040 329
SQSM		SQSMWH2030 SQSMWH2040 SQSMWH7030 SQSMWH7040 329
SQSS		SQSSBLK2030 SQSSBLK2040 SQSSBLK5030 SQSSBLK5040 331
SQSS		SQSSIL2030 SQSSIL2040 SQSSIL5030 SQSSIL5040 331
SQSS		SQSSWH2030 SQSSWH2040 SQSSWH5030 SQSSWH5040 331











RETAIL TRACK COMPONENTS

SKB11R		SKB11R1 SKB11R2 SKB11R3	320
SKB11T		SKB11T1 SKB11T2 SKB11T3	320
SKB12		SKB121 SKB122 SKB123	320
SP4R		SP4R1 SP4R2 SP4R3	320
SPR6		SPR62 SPR63	320
SPW1		SPW11 SPW12 SPW13	320
XTS11		XTS111 XTS112 XTS113	320
XTS14		XTS141 XTS142 XTS143	320
XTS21		XTS211 XTS212 XTS213	320
XTS23		XTS231 XTS232 XTS233	320
XTS24		XTS241 XTS242 XTS243	320
XTS34		XTS341 XTS342 XTS343	320
XTS35		XTS351 XTS352 XTS353	320
XTS36		XTS361 XTS362 XTS363	320

BULKHEADS



XTS37		XTS371 XTS372 XTS373	320
XTS38		XTS381 XTS382 XTS383	320
XTS39		XTS391 XTS392 XTS393	320
XTS40		XTS401 XTS402 XTS403	320
XTS4100		XTS41001 XTS41002 XTS41003	320
XTS41		XTS411 XTS412 XTS413	320
XTS4200		XTS42001 XTS42002 XTS42003	320
XTSF10		XTSF101 XTSF102 XTSF103	320
XTSF30		XTSF301 XTSF302 XTSF303	320
XTSF4100		XTSF41001 XTSF41002 XTSF41003	320
XTSF4200		XTSF42001 XTSF42002 XTSF42003	320
XTSV12		XTSV12	320
BULKHEADS			
WL92 12W		WL9212SCS WL9212MCS WL9212ECS WL9212CCS	336



BULKHEAD ACCESSORIES



WL92 19W		WL9219SCS WL9219MCS WL9219ECS WL9219CCS	337
WL92BE		WL92BE	338
WL92BR		WL92BR	338
WL92BG		WL92BG	338
HIGH BAYS			
Springbok 100W		HB10040	348
Springbok 150W		HB15040	347
Springbok 200W		HB20040	346
HIGH BAY ACCESSORIES			
Springbok HBA60		HBA60	349
Springbok HBA70		HBA70	349
Springbok HBA90		HBA90	349
Springbok HBAS		HBAS	349



Index

LOW BAYS		
Lentus 100W		LB10040 LB10040E 353
Lentus 150W		LB15040 LB15040E 352

LOW BAY ACCESSORIES		
Lentus LBA5090		LBA5090 354
Lentus LBA90		LBA90 354
Lentus LBAS		LBAS 354

INDUSTRIAL FLOODLIGHTS		
K2 100W		IFL10BX40 IFL10BX40100150 IFL10BX30 IFL10BX30100150 360
K2 150W		IFL15BX40 IFL15BX40100150 IFL15BX30 IFL15BX30100150 359
K2 200W		IFL20BX40 IFL20BX40100150 IFL20BX30 IFL20BX30100150 358

ANTI-CORROSIVES		
4ft, Single, Standard Caiman		AC4SD40 AC4SD40EM AC4SM40 AC4SM40EM AC4SS40 AC4SS40EM 368
4ft, Twin, Standard Caiman		AC4TD40 AC4TD40EM AC4TM40 AC4TM40EM AC4TS40 AC4TS40EM 369
5ft, Single, Standard Caiman		AC5SD40 AC5SD40EM AC5SM40 AC5SM40EM AC5SS40 AC5SS40EM 366

5ft, Twin, Standard Caiman		AC5TD40 AC5TD40EM AC5TM40 AC5TM40EM AC5TS40 AC5TS40EM 367
6ft, Single, Standard Caiman		AC6SD40 AC6SD40EM AC6SM40 AC6SM40EM AC6SS40 AC6SS40EM 364
6ft, Twin, Standard Caiman		AC6TD40 AC6TD40EM AC6TM40 AC6TM40EM AC6TS40 AC6TS40EM 365

COLOUR CHANGE		
DL329 RGBW		DL329RGBW 386
LL090 RGBW		LL090RGBW 384
LL030 CARGB		LL030CARGB 385

GL007 RGBW		GL007RGBW 388
GL008 RGBW		GL008RGBW 387
GL016 RGBW		GL016RGBW 391

GL040 CARGB		GL040CARGB 390
GL050 RGBW		GL050RGBW 392
GL090 RGBW		GL090RGBW 389



LSR05		LSR0527XXX LSR0530XXX LSR0540XXX 399
-------	---	--































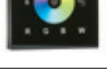





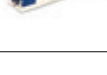

SPRGBW		SPRGBW 400
UL010 RGBW		UL010RGBW 395
UL030 RGBW		UL030RGBW 394

UL345 CARGB		UL345CARGB 396
UL346 CARGB		UL346CARGB 397
UL347 CARGB		UL347CARGB 398

WL070 RGBW		WL070RGBW 393
---------------	---	---------------

COLOUR CHANGE COMPONENTS		
C100924		C100924 378
CF505 RGBW		CF505RGBW 382
App Requires TR2818		COLLINGWOODRGBW 377

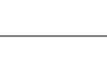
CR575 RGBW		CR575RGBW 382
DMX2102		DMX2102 379
DMX RS 485 CABLE		DMX RS 485 CABLE 383

LED 3 RGB EXT		LED 3 RGB EXT	383	PSIP 70018W		PSIP70018W	412	PS7524		PS7524	412
LEDRGBW EXT		LEDRGBWEXT	382	PSIP 70036W		PSIP70036W	412	PS1524		PS1524	412
LED RGB 0.75 CABLE		LED RGB 0,75 CABLE	383	PLDCC 350/10-28		PLDCC/350/10-28	412	PS3024B		PS3024B	412
PR3002		PR3002	381	PLDCC 700/12-24		PLDCC/700/12-24	412	PS5024		PS5024	412
PR3011		PR3011	380	PLDM 35020		PLDM35020	412	PSDAL 20024		PSDAL20024	412
RC2819		RC2819	376	PLDM 70011		PLDM70011	412	PSDAL 350M		PSDAL350M	412
TR2818		TR2818	377	PLD UNI-DRIVE 350MA		PLD UNI-DRIVE 350MA	412	PSDAL 700M		PSDAL700M	412
WC2820		WC2820BLK	376	PLD UNI-DRIVE 700MA		PLD UNI-DRIVE 700MA	412	PSDAL 900M		PSDAL900M	412
WC2820		WC2820WH	376	PLR/350 1-5		PLR/350 1-5	412	PSDIM 350		PSDIM350	412
LED DRIVERS				PLU/350 1-9		PLU/350 1-9	412	PSDIM 700		PSDIM700	412
HAL104		HAL 104	412	PLU/700 3-9		PLU/700 3-9	412	PSDIM 900		PSDIM900	412
PDCINT 1-10V		PDCINT1-10V	412	PLU/PP/350 1-9		PLU/PP/350 1-9	412	PSDIN 350M		PSDIN350M	412
PSIP 3509W		PSIP3509W	412	PLU/PP/350 1-9		PLU/PP/350 1-9	412	PSDIN 700M		PSDIN700M	412
PSIP 35018W		PSIP35018W	412	PS10024		PS10024	412	PSDIP 10024		PSDIP10024	412

Index

LED DRIVERS		
PSDIP 6024		PSDIP6024 412
PSIP 15024		PSIP15024 412
PSIP 25024		PSIP25024 412
PSMD 35039		PSMD35039 412
PSMD 3501324		PSMD3501324 412
PSMD 70024		PSMD70024 412
PSMD 700610		PSMD700610 412
PSMDIP 10024		PSMDIP10024 412
PSMD 3024		PSMD3024 412
GENERAL ACCESSORIES		
CR135		CR135 BL CR135 RED 423
IX 265		IX 265 422
IX 365		IX 365 422
JB1		JB1 422
JB2		JB2 422
JB3		JB3 422
JB4		JB4 423
JB5		JB5 423
JB6		JB6 423
JB7		JB7 423
PDC/GRID DIMMER		PDC/GRID DIMMER 422
UY2 CONNECTOR		UY2 CONNECTOR 422
WC 5-9		WC 5-9 422
WCR 275 BLACK		WCR 275 BLACK 423
WCR 375 BLACK		WCR 375 BLACK 423

1901	116	BL01FOS30	297	BL03POB30	296	DH04WH	134	DLE4727030EM	89
AC45D40	368	BL01FOS40	297	BL03POB40	296	DH05WH	134	DLE4727040	89
AC45D40EM	368	BL01FSB27	297	BL03POS27	296	DL/CONVERTBLK	106	DLE4727040D	90
AC45M40	368	BL01FSB30	297	BL03POS30	296	DL/CONVERTCR	106	DLE4727040DEM	90
AC45M40EM	368	BL01FSB40	297	BL03POS40	296	DL/CONVERTSIL	106	DLE4727040EM	89
AC45S40	368	BL01FSS27	297	BL03PSB27	296	DL120 NW	128	DLE4795527	93
AC45S40EM	368	BL01FSS30	297	BL03PSB30	296	DL120 WW	128	DLE4795527EM	93
AC4TD40	369	BL01FSS40	297	BL03PSB40	296	DL130 NW	129	DLE4795530	93
AC4TD40EM	369	BL01PIB27	297	BL03PSS27	296	DL130 WW	129	DLE4795530EM	93
AC4TM40	369	BL01PIB30	297	BL03PSS30	296	DL282WHNWDIM	105	DLE4795540	93
AC4TM40EM	369	BL01PIB40	297	BL03PSS40	296	DL282WHWWDIM	105	DLE4795540EM	93
AC4TS40	369	BL01PIS27	297	BOL LED BRACKET	298	DL329RGBW	386	DL PENDANT F NW	124
AC4TS40EM	369	BL01PIS30	297	C100924	378	DL4094528	96	DL PENDANT F WW	124
AC55D40	366	BL01PIS40	297	CF505RGBW	382	DL4094528EM	96	DL SURFACE F NW	125
AC55D40EM	366	BL01POB27	297	CO7010	163	DL4094530	96	DL SURFACE F WW	125
AC55M40	366	BL01POB30	297	CO7020	163	DL4094530EM	96	DLT2425528	94
AC55M40EM	366	BL01POB40	297	CO7ECA	163	DL4094540	96	DLT2425528EM	94
AC55S40	366	BL01POS27	297	CDL0112M	310	DL4094540EM	96	DLT388BS5530	83
AC55S40EM	366	BL01POS30	297	CDL0112MEM	310	DL48938MW30	97	DLT388BS5540	83
AC5TD40	367	BL01POS40	297	CDL0116M	311	DL48938MW40	97	DLT388CR5530	83
AC5TD40EM	367	BL01PSB27	297	CDL0116MEM	311	DL490BS5530	88	DLT388CR5540	83
AC5TM40	367	BL01PSB30	297	CDL0124M	312	DL490BS5540	88	DLT388MW5530	83
AC5TM40EM	367	BL01PSB40	297	CDL0124MEM	312	DL490CR5530	88	DLT388MW5540	83
AC5TS40	367	BL01PSS27	297	CDL0132M	313	DL490CR5540	88	DLT4074528	95
AC5TS40EM	367	BL01PSS30	297	CDL0132MEM	313	DL490MW5530	88	DLT4074528EM	95
AC6SD40	364	BL01PSS40	297	CO7ECB	163	DL490MW5540	88	DLT4074530	95
AC6SD40EM	364	BL03DIB27	296	CO7MB	163	DL801MW	314	DLT4074530EM	95
AC6SM40	364	BL03DIB30	296	COLLINGWOODRGBWAPP	377	DLCONVERT98BS	106	DLT4074540	95
AC6SM40EM	364	BL03DIB40	296	CON EXT M/F 6X12	167	DLCONVERT98CR	106	DLT4074540EM	95
AC6SS40	364	BL03DIS27	296	CON FEMALE 6X12	167	DLCONVERT98WH	106	DLT4286500	92
AC6SS40EM	364	BL03DIS30	296	CON MALE 6X12	167	DLCVT110BS	106	DLT4286500EM	92
AC6TD40	365	BL03DIS40	296	CONNECTOR 6X12	167	DLCVT110CR	106	DLT4335530	91
AC6TD40EM	365	BL03DOB27	296	CONNECTOR 6X12 5M	167	DLCVT110MW	106	DLT4335530EM	91
AC6TM40	365	BL03DOB30	296	CONNECTOR L 6X12	167	DLCVT110WH	106	DLT4335540	91
AC6TM40EM	365	BL03DOB40	296	CONNECTOR T 6X12	167	DLE4353830	99	DLT4335540EM	91
AC6TS40	365	BL03DOS27	296	CONNECTOR X 6X12	167	DLE4353830	99	DLT4365530	101
AC6TS40EM	365	BL03DOS30	296	CR135 BL	423	DLE4353830D	99	DLT4365530EM	101
ACRYLIC COVER F 1M	164	BL03DOS40	296	CR135 RED	423	DLE4353830DEM	99	DLT4365540	101
AR119SIL	131	BL03DSB27	296	CR575RGBW	382	DLE4353830EM	99	DLT4365540EM	101
AR120SIL	131	BL03DSB30	296	CWFRC001	111	DLE4353830EM	99	DLT4414528	103
AR220SIL	131	BL03DSB40	296	CWFRC002	111	DLE4353840	99	DLT4414528EM	103
BL01DIB27	297	BL03DSS27	296	CWFRC003	111	DLE4353840	99	DLT4414530	103
BL01DIB30	297	BL03DSS30	296	CWFRC004	112	DLE4353840D	99	DLT4414530EM	103
BL01DIB40	297	BL03DSS40	296	CWFRC005	112	DLE4353840DEM	99	DLT4414540	103
BL01DIS27	297	BL03FIB27	296	CWFRC006	112	DLE4353840EM	99	DLT4414540EM	103
BL01DIS30	297	BL03FIB30	296	CWFRC007	113	DLE4353840EM	99	DLT4435527	102
BL01DIS40	297	BL03FIB40	296	CWFRC008	113	DLE4357030	99	DLT4435527EM	102
BL01DOB27	297	BL03FIS27	296	CWFRC009	113	DLE4357030	99	DLT4435530	102
BL01DOB30	297	BL03FIS30	296	CWSBRI	75	DLE4357030D	99	DLT4435530EM	102
BL01DOB40	297	BL03FIS40	296	CWSE27C	75	DLE4357030DEM	99	DLT4435540	102
BL01DOS27	297	BL03FOB27	296	CWSBCC	75	DLE4357030EM	99	DLT4435540EM	102
BL01DOS30	297	BL03FOB30	296	CWSBCD	75	DLE4357030EM	99	DLT4564000	87
BL01DOS40	297	BL03FOB40	296	CWSBCR	75	DLE4357040	99	DLT4566000	86
BL01DSB27	297	BL03FOS27	296	CWSE27D	75	DLE4357040	99	DLT469BS6030	84
BL01DSB30	297	BL03FOS30	296	CWSE27R	75	DLE4357040D	99	DLT469BS6040	84
BL01DSB40	297	BL01FSB30	296	CWSGU10C	75	DLE4357040DEM	99	DLT469MW6030	84
BL01DSS27	297	BL03FOS40	296	CWSGU10D	75	DLE4357040EM	99	DLT469MW6040	84
BL01DSS30	297	BL03FSB27	296	CWSGU10R	75	DLE4357040EM	99	DLT470BS6500	85
BL01DSS40	297	BL03FSB40	296	CWSHUB	74	DLE4723830	89	DLT470MW6500	85
BL01FIB27	297	BL03FSS27	296	CWSNBR1	75	DLE4723830D	90	DM298FP	107
BL01FIB30	297	BL03FSS30	296	CWSPUK	74	DLE4723830DEM	90	DM298GRID	107
BL01FIB40	297	BL03FSS40	296	CX7010	163	DLE4723830EM	89	DMX2102	379
BL01FIS27	297	BL03PIB27	296	CX7020	163	DLE4723840	89	DMX RS 485 CABLE	383
BL01FIS30	297	BL03PIB30	296	CX7ECA	163	DLE4723840D	90	EFC3P	108
BL01FIS40	297	BL03PIB40	296	CX7ECB	163	DLE4723840DEM	90	FIBRE LED 1/30	127
BL01FOB27	297	BL03PIS27	296	CX7ECC	163	DLE4723840EM	89	FIBRE LED 2/30	127
BL01FOB30	297	BL03PIS30	296	CX7ECD	163	DLE4727030	89	FIBRE LED LIGHT NW	126
BL01FOB40	297	BL03PIS40	296	DH02WH	134	DLE4727030D	90	FL01BPXS	192
BL01FOS27	297	BL03POB27	296	DH03WH	134	DLE4727030DEM	90	FL01BXCS	192

FL02BPCS.....	193	GL019 F BLUE.....	213	GL051 NW.....	231	GL200DX4X27.....	229	LED LYTE IP T 27.....	152
FL02BXCS.....	193	GL019 F GREEN.....	213	GL051 WW.....	231	GL200DX4X30.....	229	LED LYTE IP T BL.....	152
FL03BPCS.....	194	GL019 F NW.....	213	GL063.....	224	GL200DX4X40.....	229	LED LYTE IP T NW.....	152
FL03BXCS.....	194	GL019 F RED.....	213	GL063 27.....	224	GLA01.....	237	LED LYTE SURFACE 27.....	150
FL05BPCS.....	195	GL019 F WW.....	213	GL064.....	225	GS220B.....	282	LED LYTE SURFACE NW.....	150
FL05BXCS.....	195	GL019DNBL40.....	214	GL064 27.....	225	GS220D.....	282	LED LYTE SURFACE WW.....	150
FL10BXCS.....	196	GL019LGF27.....	215	GL07D24X27.....	206	GS220Z.....	282	LED LYTE WW.....	153
FL200F27.....	197	GL019LGFNW.....	215	GL07D24X30.....	206	HAL 104.....	414	LED RGB 0.75 CABLE.....	383
FL200FNW.....	197	GL019LGFWW.....	215	GL07D24X40.....	206	HB10040.....	348	LEDLINE 400 WW 45.....	274
FL200FWW.....	197	GL019LGS27.....	215	GL07D38X27.....	206	HB15040.....	347	LEDRGBWEXT.....	382
GH220B.....	282	GL019LGSNW.....	215	GL07D38X30.....	206	HB20040.....	346	LEDSTRIP IP AMB.....	187
GH220D.....	282	GL019 S 27.....	213	GL07D38X40.....	206	HBA60.....	349	LEDSTRIP IP BL.....	187
GH220Z.....	282	GL019 S AMBER.....	213	GL07D60X27.....	206	HBA70.....	349	LEDSTRIP IP NW.....	187
GL007 FROSTED NW.....	207	GL019 S BLUE.....	213	GL07D60X30.....	206	HBA90.....	349	LEDSTRIP IP RED.....	187
GL007 FROSTED WW.....	207	GL019 S GREEN.....	213	GL07D60X40.....	206	HBAS.....	349	LEDSTRIP IP WW.....	187
GL007RGBW.....	388	GL019 S NW.....	213	GL08D24X27.....	205	IFL10040.....	360	LINE PROF END CAP.....	164
GL008RGBW.....	387	GL019 S RED.....	213	GL08D24X30.....	205	IFL10BX30.....	360	LINE PROF FIX CLIP.....	164
GL016DCOF27.....	223	GL019 S WW.....	213	GL08D24X40.....	205	IFL10BX30100150.....	360	LINE PROFILE 20MM 1M.....	164
GL016DCOF30.....	223	GL019 SQ F BLUE.....	217	GL08D38X27.....	205	IFL10BX40.....	360	LL030CARGB.....	385
GL016 F 27.....	220	GL019 SQ F NW.....	217	GL08D38X30.....	205	IFL10BX40100150.....	360	LL090RGBW.....	384
GL016 F AB 27.....	221	GL019 SQ F WW.....	217	GL08D38X40.....	205	IFL15040.....	359	LSBFC10.....	166
GL016 F AB AMBER.....	221	GL019 SQ S BLUE.....	217	GL08D60X27.....	205	IFL15BX30100150.....	359	LSBFC8.....	166
GL016 F AB BLUE.....	221	GL019 SQ S NW.....	217	GL08D60X30.....	205	IFL15BX40.....	359	LSBFCD10.....	166
GL016 F AB GREEN.....	221	GL019 S T 27.....	218	GL08D60X40.....	205	IFL15BX40100150.....	359	LSBFCD8.....	166
GL016 F AB NW.....	221	GL019 S T BLUE.....	218	GL090 F 27.....	208	IFL20040.....	358	LSBFCS10.....	166
GL016 F AB RED.....	221	GL019 S T NW.....	218	GL090 F BL.....	208	IFL20BX30100150.....	358	LSBFCS8.....	166
GL016 F AB WW.....	221	GL019 S T WW.....	218	GL090 F NW.....	208	IFL20BX40.....	358	LSC0327XXX.....	183
GL016 F AMBER.....	220	GL019 S TK 27.....	219	GL090 F WW.....	208	IFL20BX40100150.....	358	LSC0330XXX.....	183
GL016 F BLUE.....	220	GL019 S TK BLUE.....	219	GL090 S 27.....	208	IX 265.....	422	LSC0340XXX.....	183
GL016 F GREEN.....	220	GL019 S TK NW.....	219	GL090 S BL.....	208	IX 365.....	422	LSC4327XXX.....	184
GL016 F NW.....	220	GL019LGSWW.....	215	GL090 S NW.....	208	JB1.....	422	LSC4330XXX.....	184
GL016 F RED.....	220	GL021 27.....	244	GL090 S WW.....	208	JB2.....	422	LSC4340XXX.....	184
GL016 F WW.....	220	GL021 BLUE.....	244	GL090RGBW.....	389	JB3.....	422	LSC4527XXX.....	185
GL016DCOF40.....	223	GL021 NW.....	244	GL09D24X27.....	204	JB4.....	423	LSC4530XXX.....	185
GL016 SQ 27.....	222	GL021 WW.....	244	GL09D24X30.....	204	JB5.....	423	LSC4540XXX.....	185
GL016 SQ BLUE.....	222	GL022 27.....	245	GL09D24X40.....	204	JB6.....	423	LSC8327XXX.....	186
GL016 SQ NW.....	222	GL022 BLUE.....	245	GL09D38X27.....	204	JB7.....	423	LSC8330XXX.....	186
GL016 SQ WW.....	222	GL022 NW.....	245	GL09D38X30.....	204	LB10040.....	353	LSC8340XXX.....	186
GL016RGBW.....	391	GL022 WW.....	245	GL09D38X40.....	204	LB15040.....	352	LSC8EXT.....	167
GL018 C 27.....	232	GL034DWBM27.....	246	GL09D60X27.....	204	LBA5090.....	354	LSC8PWL.....	167
GL018 C AB 27.....	233	GL034DWBM30.....	246	GL09D60X30.....	204	LBA90.....	354	LSFC12.....	164
GL018 C AB AMBER.....	233	GL034DWBM40.....	246	GL09D60X40.....	204	LBAS.....	354	LSFCD12.....	164
GL018 C AB BLUE.....	233	GL038DWBM27.....	212	GL100DX1X27.....	226	LED 3 RGB EXT.....	383	LSFCS12.....	164
GL018 C AB GREEN.....	233	GL038DWBM30.....	212	GL100DX1X30.....	226	LED COVE PACK 1M.....	165	LSR0527XXX.....	399
GL018 C AB NW.....	233	GL038DWBM40.....	212	GL100DX1X40.....	226	LEDEP06.....	109	LSR0530XXX.....	399
GL018 C AB RED.....	233	GL040CARGB.....	390	GL100DX2127.....	226	LEDEP08.....	135	LSR0540XXX.....	399
GL018 C AB WW.....	233	GL040DMBL27.....	210	GL100DX2130.....	226	LEDEP09.....	315	LSV0227050.....	168
GL018 C AMBER.....	232	GL040DMBL30.....	210	GL100DX2140.....	226	LEDLINE 400 27 110.....	268	LSV0230050.....	168
GL018 C BLUE.....	232	GL040DMBL40.....	210	GL100DX2227.....	226	LEDLINE 400 27 25X6.....	271	LSV0240050.....	168
GL018 C GREEN.....	232	GL040DNBL27.....	210	GL100DX2230.....	226	LEDLINE 400 27 45.....	274	LSV0265050.....	168
GL018 C NW.....	232	GL040DNBL30.....	210	GL100DX2240.....	226	LEDLINE 400 NW 110.....	268	LSV0427050.....	170
GL018 C RED.....	232	GL040DNBL40.....	210	GL100DX3X27.....	227	LEDLINE 400 NW 25X6.....	271	LSV0430050.....	170
GL018 C WW.....	232	GL040DWBX27.....	209	GL100DX3X30.....	227	LEDLINE 400 NW 45.....	274	LSV0440050.....	170
GL018 SQ 27.....	234	GL040DWBX30.....	209	GL100DX3X40.....	227	LEDLINE 400 WW 110.....	268	LSV0465050.....	170
GL018 SQ BLUE.....	234	GL040DNBX27.....	209	GL100DX4X27.....	227	LEDLINE 400 WW 25X6.....	271	LSV0527050.....	169
GL018 SQ NW.....	234	GL040DNBX30.....	209	GL100DX4X30.....	227	LED LYTE 1M EXT.....	154	LSV0530050.....	169
GL018 SQ WW.....	234	GL040DNBX40.....	209	GL100DX4X40.....	227	LED LYTE 27.....	153	LSV0540050.....	169
GL018 T BLUE.....	235	GL040DWBX40.....	209	GL200DX1X27.....	228	LED LYTE 6 WAY EXT.....	164	LSV0565050.....	169
GL018 T NW.....	235	GL041 F NW.....	211	GL200DX1X30.....	228	LED LYTE AMBER.....	153	LSV0627050.....	171
GL019DCOF27.....	216	GL041 F WW.....	211	GL200DX1X40.....	228	LED LYTE BLUE.....	153	LSV0630050.....	171
GL019DCOF30.....	216	GL041 S NW.....	211	GL200DX2127.....	228	LED LYTE NW.....	153	LSV0640050.....	171
GL019DCOF40.....	216	GL041 S WW.....	211	GL200DX2130.....	228	LED LYTE RED.....	153	LSV0665050.....	171
GL019DMBL27.....	214	GL050 27.....	230	GL200DX2140.....	228	LED LYTE IP 27.....	151	LSV4227050.....	172
GL019DMBL30.....	214	GL050 BLUE.....	230	GL200DX2227.....	228	LED LYTE IP AMBER.....	151	LSV4230050.....	172
GL019DMBL40.....	214	GL050 NW.....	230	GL200DX2230.....	228	LED LYTE IP BLUE.....	151	LSV4240050.....	172
GL019DNBL27.....	214	GL050 WW.....	230	GL200DX2240.....	228	LED LYTE IP GREEN.....	151	LSV4265050.....	172
GL019DNBL30.....	214	GL050RGBW.....	392	GL200DX3X27.....	229	LED LYTE IP NW.....	151	LSV4427050.....	174
GL019 F 27.....	213	GL051 27.....	231	GL200DX3X30.....	229	LED LYTE IP RED.....	151	LSV4430050.....	174
GL019 F AMBER.....	213	GL051 BLUE.....	231	GL200DX3X40.....	229	LED LYTE IP WW.....	151	LSV4440050.....	174

LSV4465050.....	174	ML02 RED.....	148	PSDAL20024.....	414	RHCL.....	325	SL230ZWBX40.....	288
LSV4527050.....	173	ML02 WW.....	148	PSDAL350M.....	414	RHCM.....	325	SL230ZWBX40.....	288
LSV4530050.....	173	ML03 27.....	149	PSDAL700M.....	414	RHCS.....	325	SL240BWB27.....	287
LSV4540050.....	173	ML03 AMBER.....	149	PSDAL900M.....	414	RP28010.....	162	SL240BWB30.....	287
LSV4565050.....	173	ML03 BLUE.....	149	PSDIM350.....	414	RP28020.....	162	SL240BWB40.....	287
LSV4627050.....	175	ML03 GREEN.....	149	PSDIM700.....	414	RP7010.....	162	SL240ZWB27.....	287
LSV4630050.....	175	ML03 NW.....	149	PSDIM900.....	414	RP7020.....	162	SL240ZWB30.....	287
LSV4640050.....	175	ML03 RED.....	149	PSDIN350M.....	414	RP7ECA.....	162	SL240BWBX27.....	286
LSV4665050.....	175	ML03 WW.....	149	PSDIN700M.....	414	RP7ECB.....	162	SL240BWBX30.....	286
LSV8227050.....	176	MS02 IP 27.....	143	PSDIP10024.....	414	SKB11R1.....	320	SL240BWBX40.....	286
LSV8230050.....	176	MS02 IP AMBER.....	143	PSDIP6024.....	414	SKB11R2.....	320	SL240ZWB40.....	287
LSV8240050.....	176	MS02 IP BLUE.....	143	PSIP15024.....	414	SKB11R3.....	320	SL240ZWB40.....	287
LSV8265050.....	176	MS02 IP GREEN.....	143	PSIP25024.....	414	SKB11T1.....	320	SL240ZWBX27.....	286
LSV8427050.....	178	MS02 IP NW.....	143	PSIP70018W.....	414	SKB11T2.....	320	SL240ZWBX30.....	286
LSV8430050.....	178	MS02 IP RED.....	143	PSIP70036W.....	414	SKB11T3.....	320	SL240ZWBX40.....	286
LSV8440050.....	178	MS02 IP WW.....	143	PSMD3024.....	414	SKB121.....	320	SL240ZWBX40.....	286
LSV8465050.....	178	OCTOLED27.....	258	PSMD3501324.....	414	SKB122.....	320	SL250A1.....	291
LSV8527050.....	177	OCTOLEDNW.....	258	PSMD35039.....	414	SKB123.....	320	SL250ATX0X27.....	290
LSV8530050.....	177	OCTOLEDDW.....	258	PSMD70024.....	414	SL030 F 27.....	284	SL250ATX0X30.....	290
LSV8540050.....	177	P1SK.....	307	PSMD700610.....	414	SL030 F AMBER.....	284	SL250ATX0X40.....	290
LSV8565050.....	177	P1SKC.....	307	PSMDIP10024.....	414	SL030 F BLUE.....	284	SL250BPX0X27.....	290
LSV8627050.....	179	P1SMA.....	307	RB359BLK.....	98	SL030 F GREEN.....	284	SL250BPX0X30.....	290
LSV8630050.....	179	P1SMB.....	307	RB359BS.....	98	SL030 F NW.....	284	SL250BPX0X40.....	290
LSV8640050.....	179	P1SMC.....	307	RB359CR.....	98	SL030 F RED.....	284	SL250CTX0X27.....	290
LSV8665050.....	179	P2A19S30W.....	304	RB359MW.....	98	SL030 F WW.....	284	SM28010.....	162
MC010 S 27.....	139	P2A19S40W.....	304	RB359PG.....	98	SL040A F 27.....	283	SM28020.....	162
MC010 S AMBER.....	139	P2A22D30W.....	304	RB359SIL.....	98	SL040A F NW.....	283	SM28ECA.....	162
MC010 S BLUE.....	139	P2A22D40W.....	304	RB359WH.....	98	SL040A F WW.....	283	SM28MB.....	162
MC010 S GREEN.....	139	P2A22S30W.....	304	RB442BS.....	104	SL040A S 27.....	283	SM7010.....	162
MC010 S NW.....	139	P2A22S40W.....	304	RB442CR.....	104	SL040A S NW.....	283	SM7020.....	162
MC010 S RED.....	139	P2A22V30W.....	304	RB442MW.....	104	SL040A S WW.....	283	SM7ECA.....	162
MC010 S WW.....	139	P2A22V40W.....	304	RB442WH.....	104	SL13027.....	285	SM7ECB.....	162
MC015 S 27.....	140	P2C22D60W.....	305	RC2819.....	376	SL13030.....	285	SM7LC.....	162
MC015 S NW.....	140	P2C22S60W.....	305	RDSLBLK2030.....	326	SL13040.....	285	SM7MA.....	162
MC015 S WW.....	140	P2C22V60W.....	305	RDSLBLK2040.....	326	SL130ZMBX27.....	285	SP4R1.....	320
MC020 S 27.....	138	P3A19D30W.....	304	RDSLBLK7030.....	326	SL130ZMBX30.....	285	SP4R2.....	320
MC020 S AMBER.....	138	P3A19D40W.....	304	RDSLBLK7040.....	326	SL130ZMBX40.....	285	SP4R3.....	320
MC020 S BLUE.....	138	P3A19V30W.....	304	RDSLIL2030.....	326	SL220BWBX27.....	280	SP5027.....	180
MC020 S GREEN.....	138	P3A19V40W.....	304	RDSLIL2040.....	326	SL220BWB27.....	281	SP5030.....	180
MC020 S NW.....	138	P3B19D30W.....	306	RDSLIL7030.....	326	SL220BWB30.....	281	SP5040.....	180
MC020 S RED.....	138	P3B19S30W.....	306	RDSLIL7040.....	326	SL220BWB40.....	281	SP5427.....	181
MC020 S WW.....	138	P3B19V30W.....	306	RDSLWH2030.....	326	SL220BWBX30.....	280	SP5430.....	181
MC025 S 27.....	141	P3C19D60W.....	305	RDSLWH2040.....	326	SL220BWBX40.....	280	SP15427.....	182
MC025 S NW.....	141	P3C19S60W.....	305	RDSLWH7030.....	326	SL220CWBM27.....	281	SP15430.....	182
MC040 27.....	259	P3C19V60W.....	305	RDSLWH7040.....	326	SL220CWBX27.....	280	SP15435.....	182
MC040 NW.....	259	PDC/GRID DIMMER.....	422	RDSMBLK2030.....	328	SL220DWBX27.....	280	SP15440.....	182
MC040 WW.....	259	PDCINT1-10V.....	414	RDSMBLK2040.....	328	SL220DWBM27.....	281	SP5435.....	181
MC050 27.....	256	PSIP35018W.....	414	RDSMBLK7030.....	328	SL220DWBM30.....	281	SP5440.....	181
MC050 NW.....	256	PSIP3509W.....	414	RDSMBLK7040.....	328	SL220DWBM40.....	281	SPR62.....	320
MC050 WW.....	256	PLDCC/350/10-28.....	414	RDSMSIL2030.....	328	SL220DWBM40.....	281	SPR63.....	320
MF02 IP 27.....	142	PLDCC/700/12-24.....	414	RDSMSIL2040.....	328	SL220DWBX30.....	280	SPRGBW.....	401
MF02 IP AMBER.....	142	PLDM35020.....	414	RDSMSIL7030.....	328	SL220DWBX40.....	280	SPSIL2M.....	165
MF02 IP BLUE.....	142	PLDM70011.....	414	RDSMSIL7040.....	328	SL220ZWBX27.....	280	SPW11.....	320
MF02 IP GREEN.....	142	PLD UNI-DRIVE 350MA.....	414	RDSMWH2030.....	328	SL220ZWB27.....	281	SPW12.....	320
MF02 IP NW.....	142	PLD UNI-DRIVE 700MA.....	414	RDSMWH2040.....	328	SL220ZWB30.....	281	SPW13.....	320
MF02 IP RED.....	142	PLR/350 1-5.....	414	RDSMWH7030.....	328	SL220ZWBX30.....	280	SQB360BLK.....	101
MF02 IP WW.....	142	PLU/350 1-9.....	414	RDSMWH7040.....	328	SL220ZWBX40.....	280	SQB360CR.....	101
ML01 27.....	147	PLU/700 3-9.....	414	RDSSBLK2030.....	330	SL230BWB27.....	289	SQB360MW.....	101
ML01 AMBER.....	147	PLU/PP/350 1-9.....	414	RDSSBLK2040.....	330	SL230BWB30.....	289	SQB360PG.....	101
ML01 BLUE.....	147	PLU/PP6/350 1-9.....	414	RDSSBLK5030.....	330	SL230BWB40.....	289	SQB360SIL.....	101
ML01 GREEN.....	147	PR3002.....	381	RDSSBLK5040.....	330	SL230ZWB27.....	289	SQSLBLK2030.....	327
ML01 NW.....	147	PR3011.....	380	RDSSSIL2030.....	330	SL230ZWB30.....	289	SQSLBLK2040.....	327
ML01 RED.....	147	PROFILE 6X12 BLK 1M.....	164	RDSSSIL2040.....	330	SL230BWBX27.....	288	SQSLBLK7030.....	327
ML01 WW.....	147	PROFILE 6X12 SIL 1M.....	164	RDSSSIL5030.....	330	SL230BWBX30.....	288	SQSLBLK7040.....	327
ML02 27.....	148	PS10024.....	414	RDSSSIL5040.....	330	SL230BWB40.....	288	SQSLSIL2030.....	327
ML02 AMBER.....	148	PS1524.....	414	RDSSWH2030.....	330	SL230ZWB27.....	289	SQSLSIL2040.....	327
ML02 BLUE.....	148	PS3024B.....	414	RDSSWH2040.....	330	SL230ZWB30.....	289	SQSLSIL7030.....	327
ML02 GREEN.....	148	PS5024.....	414	RDSSWH5030.....	330	SL230ZWB40.....	289	SQSLSIL7040.....	327
ML02 NW.....	148	PS7524.....	414	RDSSWH5040.....	330	SL230ZWBX27.....	288	SQSLWH2030.....	327

SQSLWH2040.....	327	SQSSBLK2030.....	331	ULM346M30.....	272	WL220DWBM40.....	255	XTS411.....	320
SQSLWH7030.....	327	SQSSBLK2040.....	331	ULM346M40.....	272	WL220ZWBM27.....	255	XTS412.....	320
SQSLWH7040.....	327	SQSSBLK5030.....	331	ULM347M27.....	275	WL220ZWBM30.....	255	XTS413.....	320
SQSMBLK2030.....	329	SQSSBLK5040.....	331	ULM347M30.....	275	WL220ZWBM40.....	255	XTS42001.....	320
SQSMBLK2040.....	329	SQSSSIL2030.....	331	ULM347M40.....	275	WL240A F 27.....	257	XTS42002.....	320
SQSMBLK7030.....	329	SQSSSIL2040.....	331	ULS345M27.....	270	WL240A F NW.....	257	XTS42003.....	320
SQSMBLK7040.....	329	SQSSSIL5030.....	331	ULS345M30.....	270	WL240A F WW.....	257	XTSF101.....	320
SM28010.....	162	SQSSSIL5040.....	331	ULS345M40.....	270	WL33927.....	240	XTSF102.....	320
SM28020.....	162	SQSSWH2030.....	331	ULS346M27.....	273	WL339NW.....	240	XTSF103.....	320
SM28ECA.....	162	SQSSWH2040.....	331	ULS346M30.....	273	WL339WW.....	240	XTSF301.....	320
SM28MB.....	162	SQSSWH5030.....	331	ULS346M40.....	273	WL34027.....	241	XTSF302.....	320
SM7010.....	162	SQSSWH5040.....	331	ULS347M27.....	276	WL340NW.....	241	XTSF303.....	320
SM7020.....	162	TLBLK2030.....	322	ULS347M30.....	276	WL340WW.....	241	XTSF41001.....	320
SM7ECA.....	162	TLBLK2040.....	322	U PROFILE 6X12 1M.....	164	WL34127.....	242	XTSF41002.....	320
SM7ECB.....	162	TLBLK7030.....	322	ULS347M40.....	276	WL341NW.....	242	XTSF41003.....	320
SM7LC.....	162	TLBLK7040.....	322	UY2 CONNECTOR.....	422	WL341WW.....	242	XTSF42001.....	320
SM7MA.....	162	TLSIL2030.....	322	WB/M 01.....	144	WL34227.....	243	XTSF42002.....	320
SP4R1.....	320	TLSIL2040.....	322	WB/M 02.....	144	WL342NW.....	243	XTSF42003.....	320
SP4R2.....	320	TLSIL7030.....	322	WB/M 02/30 DEGREE.....	144	WL342WW.....	243	XTSV12.....	320
SP4R3.....	320	TLSIL7040.....	322	WB/M BOX.....	144	WL92BE.....	338		
SP5027.....	180	TLWH2030.....	322	WC2820BLK.....	376	WL9212CCS.....	336		
SP5030.....	180	TLWH2040.....	322	WC 5-9.....	422	WL9212ECS.....	336		
SP5040.....	180	TLWH7030.....	322	WC2820WH.....	376	WL9212MCS.....	336		
SP5427.....	181	TLWH7040.....	322	WCR 275 BLACK.....	423	WL9212SCS.....	336		
SP5430.....	181	TMBLK2030.....	323	WCR 375 BLACK.....	423	WL9219CCS.....	337		
SP5435.....	181	TMBLK2040.....	323	WL041 IP 27.....	254	WL9219ECS.....	337		
SP5440.....	181	TMBLK7030.....	323	WL041 IP AMBER.....	254	WL9219MCS.....	337		
SP15427.....	182	TMBLK7040.....	323	WL041 IP BLUE.....	254	WL9219SCS.....	337		
SP15430.....	182	TMSIL2030.....	323	WL041 IP NW.....	254	WL92BG.....	338		
SP15435.....	182	TMSIL2040.....	323	WL041 IP WW.....	254	WL92BR.....	338		
SP15440.....	182	TMSIL7030.....	323	WL050 NW.....	145	XTS111.....	320		
SPR62.....	320	TMSIL7040.....	323	WL050 WALL BOX.....	146	XTS112.....	320		
SPR63.....	320	TMWH2030.....	323	WL050 WW.....	145	XTS113.....	320		
SPRGBW.....	400	TMWH2040.....	323	WL060 27.....	251	XTS141.....	320		
SPSIL2M.....	165	TMWH7030.....	323	WL060 NW.....	251	XTS142.....	320		
SPW11.....	320	TMWH7040.....	323	WL060 WW.....	251	XTS143.....	320		
SPW12.....	320	TR2818.....	377	WL070BNBM27.....	250	XTS211.....	320		
SPW13.....	320	TSBLK2030.....	324	WL070BNBM30.....	250	XTS212.....	320		
SQB360BLK.....	101	TSBLK2040.....	324	WL070BNBM40.....	250	XTS213.....	320		
SQB360CR.....	101	TSBLK5030.....	324	WL070CNBM27.....	250	XTS231.....	320		
SQB360MW.....	101	TSBLK5040.....	324	WL070CNBM30.....	250	XTS232.....	320		
SQB360PG.....	101	TSSIL2030.....	324	WL070RGBW.....	393	XTS233.....	320		
SQB360SIL.....	101	TSSIL2040.....	324	WL070SNBM27.....	250	XTS241.....	320		
SQSLBLK2030.....	327	TSSIL5030.....	324	WL070SNBM30.....	250	XTS242.....	320		
SQSLBLK2040.....	327	TSSIL5040.....	324	WL070SNBM40.....	250	XTS243.....	320		
SQSLBLK7030.....	327	TSWH2030.....	324	WL070ZNBM27.....	250	XTS341.....	320		
SQSLBLK7040.....	327	TSWH2040.....	324	WL070ZNBM30.....	250	XTS342.....	320		
SQSLSIL2030.....	327	TSWH5030.....	324	WL070ZNBM40.....	250	XTS343.....	320		
SQSLSIL2040.....	327	TSWH5040.....	324	WL075BNBM27.....	253	XTS351.....	320		
SQSLSIL7030.....	327	TUBE/332.....	236	WL075BNBM30.....	253	XTS352.....	320		
SQSLSIL7040.....	327	TUBE/50.....	236	WL075BNBM40.....	253	XTS353.....	320		
SQSLWH2030.....	327	TUBE/68.....	236	WL075SNBM27.....	253	XTS361.....	320		
SQSLWH2040.....	327	UL010 27.....	265	WL075SNBM30.....	253	XTS362.....	320		
SQSLWH7030.....	327	UL010 BL.....	265	WL075SNBM40.....	253	XTS363.....	320		
SQSLWH7040.....	327	UL010 NW.....	265	WL075ZNBM27.....	253	XTS371.....	320		
SQSMBLK2030.....	329	UL010 WW.....	265	WL075ZNBM30.....	253	XTS372.....	320		
SQSMBLK2040.....	329	UL010RGBW.....	395	WL075ZNBM40.....	253	XTS373.....	320		
SQSMBLK7030.....	329	UL030DNBX27.....	264	WL140A F 27.....	256	XTS381.....	320		
SQSMBLK7040.....	329	UL030DNBX30.....	264	WL140A F NW.....	256	XTS382.....	320		
SQSMSIL2030.....	329	UL030DNBX40.....	264	WL140A F WW.....	256	XTS383.....	320		
SQSMSIL2030.....	329	UL030RGBW.....	394	WL160 27.....	250	XTS391.....	320		
SQSMSIL2040.....	329	UL345CARGB.....	396	WL160 NW.....	250	XTS392.....	320		
SQSMSIL2040.....	329	UL346CARGB.....	397	WL160 WW.....	250	XTS393.....	320		
SQSMSIL7030.....	329	UL347CARGB.....	398	WL220BWBM27.....	255	XTS401.....	320		
SQSMSIL7040.....	329	ULBRACKET.....	277	WL220BWBM30.....	255	XTS402.....	320		
SQSMWH2030.....	329	ULM345M27.....	269	WL220BWBM40.....	255	XTS403.....	320		
SQSMWH2040.....	329	ULM345M30.....	269	WL220DWBM27.....	255	XTS41001.....	320		
SQSMWH7030.....	329	ULM345M40.....	269	WL220CWBM27.....	255	XTS41002.....	320		
SQSMWH7040.....	329	ULM346M27.....	272	WL220DWBM30.....	255	XTS41003.....	320		

Collingwood Lighting Limited terms and conditions of trading

1. INTERPRETATION

- 1.1 In these Conditions the following words have the following meanings:
"Buyer" the person(s), firm or company from whom an order to supply Goods is received by the Company;
"Buyer Materials" any documents or other materials and any data or other information provided by the Buyer relating to the Goods;
"Company" Collingwood Lighting Limited, a company incorporated in England and Wales (company number 900626) whose registered office is at Brooklands House, Sywell Aerodrome, Sywell, Northampton, NN6 0BT.
"Company Materials" any documents or other materials, and any data or other information provided by the Company relating to the Goods;
"Conditions" the standard terms and conditions of sale as set out in this document together with any special terms and conditions agreed in writing between the Buyer and the Company.
"Contract" any contract between the Company and the Buyer for the sale of Goods;
"Delivery Point" the place where delivery of the Goods is to take place under Condition 4.1;
"Goods" any goods (or parts thereof) to be supplied to the Buyer by the Company.
- 1.2 In these Conditions: references to any statute or statutory provision shall, unless the context otherwise requires, be construed as a reference to that statute or statutory provision as from time to time amended, consolidated, modified, extended, re-enacted or replaced; references to the masculine include the feminine and the neuter and to the singular include the plural and vice versa as the context requires; and headings will not affect the construction of these Conditions.

2. APPLICATION OF TERMS

- 2.1 These Conditions apply to all the Company's sales of Goods and any variation to these Conditions and any representations about the Goods shall have no effect unless expressly agreed in writing and signed by a director of the Company.
- 2.2 No terms or conditions endorsed upon, delivered with or contained in the Buyer's purchase order, confirmation of order or other document will form part of the Contract simply as a result of such document being referred to in the Contract.
- 2.3 Each order for Goods by the Buyer from the Company shall be deemed to be an offer by the Buyer to purchase Goods subject to these Conditions.
- 2.4 Orders should be in writing, and should state the Buyer's relevant order number. Verbal orders will be accepted but the Buyer will be responsible for any errors of description or quantity or date of delivery in Goods supplied thereunder.
- 2.5 No order placed by the Buyer shall be deemed to be accepted by the Company until the Company issues a written acknowledgement or (if earlier) the Company delivers the Goods to the Buyer.
- 2.6 The Buyer must ensure that the terms of any order or related document are complete and accurate.
- 2.7 Unless otherwise stated any quotation is valid for a period of 30 days only from its date, provided that the Company has not previously withdrawn it.
- 2.8 A credit limit applies to every account and will be disclosed on request or will be automatically disclosed if the Buyer's order would cause the credit limit to be exceeded.

3. DESCRIPTION

- 3.1 The description of the Goods shall be as set out in the Company's price list.
- 3.2 All descriptive matter and advertising issued by the Company and any descriptions or illustrations contained in the Company's documentation are issued or published for the sole purpose of giving an approximate idea of the Goods described in them. They will not form part of this Contract.
- 3.3 The Buyer should always ensure that the Goods ordered are suitable for the intended purpose before commencing installation, bulk production or investment in tooling.
4. DELIVERY
- 4.1 Unless otherwise agreed in writing by the Company delivery of the Goods shall take place at the address detailed in the Buyer's order.
- 4.2 Any dates specified by the Company for delivery of the Goods are intended to be an estimate and time for delivery shall not be made of the essence by notice.
- 4.3 Subject to the other provisions of these Conditions the Company will not be liable for any loss (including loss of profit), costs, damages, charges or expenses caused directly or indirectly by any delay in the delivery of the Goods (even if caused by the Company's negligence), nor will any delay entitle the Buyer to terminate the Contract.
- 4.4 If for any reason the Buyer will not accept delivery of any of the Goods, or the Company is unable to deliver the Goods on time because the Buyer has not provided appropriate instructions, documents, licences or authorisations: risk in the Goods will pass to the Buyer (including loss or damage caused by negligence); the Goods will be deemed to have been delivered; and the Company may store the Goods until delivery whereupon the Buyer will be liable for all related costs and expenses (including without limitation storage and insurance).
- 4.5 The Buyer will provide at its expense at the Delivery Point adequate and appropriate equipment and manual labour for loading the Goods.
- 4.6 The Company may deliver the Goods by instalments and each instalment shall be treated as a separate Contract so that failure to deliver or defect in one or more instalment shall not entitle the Buyer to reject the other instalments.

5. NON-DELIVERY

- 5.1 The quantity of any consignment of Goods as recorded by the Company upon despatch from the Company's place of business shall be conclusive evidence of the quantity received by the Buyer.
- 5.2 The Company shall not be liable for any non-delivery of Goods (even if caused by the Company's negligence) unless written notice is given to the Company within 3 days of the date when the Goods would in the ordinary course of events have been received.
- 5.3 Any liability of the Company for non-delivery of the Goods shall be limited to replacing the Goods within a reasonable time or issuing a credit note at the pro rata Contract rate against any invoice raised for such Goods.

6. RISK/TITLE

- 6.1 The Goods are at the risk of the Buyer from the time of delivery.
- 6.2 Ownership of the Goods shall not pass to the Buyer until the Company has received in full (in cash or cleared funds) all sums due to it from the Buyer on any account.
- 6.3 Until ownership of the Goods has passed to the Buyer, the Buyer must: hold the Goods on a fiduciary basis as the Company's bailee; store the Goods (at no cost to the Company) separately from all other goods in such a way that they remain readily identifiable as the Company's property; not destroy, deface or obscure any identifying mark or packaging on or relating to the Goods; maintain the Goods in satisfactory condition insured on the Company's behalf for their full price against all risks to the reasonable satisfaction of the Company. (On request the Buyer shall produce the policy of insurance to the Company and hold the proceeds of the insurance referred to in on trust for the Company and not mix them with any other money, nor pay the proceeds into an overdrawn bank account.)
- 6.4 The Buyer may resell the Goods before ownership has passed to it on the following conditions:
6.4.1 any sale shall be effected in the ordinary course of the Buyer's business at full market value; and
6.4.2 any such sale shall be a sale of the Company's property on the Buyer's own behalf and the Buyer shall deal as principal when making such a sale.
- 6.5 If the Buyer resells any of the Goods on a retail basis it will be responsible for complying with all applicable laws and for the provision of proper labels and instructions as required by the Department of Trade and Industry and/or any other authority for the time being empowered to make any requirements as to the sale or installation of such Goods.
- 6.6 The Buyer's right to possession of the Goods shall terminate immediately if:
6.6.1 the Buyer has a bankruptcy order made against him or makes an arrangement or composition with his creditors, or otherwise takes the benefit of any relief for insolvent debtors, or (being a body corporate) convenes a meeting of creditors (whether formal or informal), or enters into liquidation except a solvent voluntary liquidation for the purpose of reconstruction or amalgamation, or has a receiver and/or manager, administrator or administrative receiver appointed of its undertaking or any part thereof, or a resolution is passed or a petition presented to any court for the winding up of the Buyer or for the granting of an administration order in respect of the Buyer, or any proceedings are commenced relating to the insolvency or possible insolvency of the Buyer; or
6.6.2 the Buyer suffers or allows any execution, whether legal or equitable, to be levied on his/its property or obtained against him/it, or fails to observe/perform any of his/its obligations under the Contract or any other contract between the Company and the Buyer, or is unable to pay its debts within the meaning of section 123 of the Insolvency Act 1986 or the Buyer ceases to trade; or

- 6.6.3 the Buyer encumbers or in any way charges any of the Goods.
- 6.7 The Company shall be entitled to recover payment for the Goods notwithstanding that ownership of any of the Goods has not passed from the Company.
- 6.8 The Buyer grants the Company, its agents and employees an irrevocable licence at any time to enter any premises where the Goods are or may be stored in order to inspect them, or, where the Buyer's right to possession has terminated, to recover them.

7. PRICE

- 7.1 Unless otherwise agreed by the Company in writing (and except in cases of obvious error) the price for the Goods shall be the price set out in the Company's price list as in force at the date of invoice.
- 7.2 Where the Company and the Buyer agree a discount in respect of the Company's price list any such discount will only apply where confirmed by the Company in writing and where payment is received from the Buyer in full within 14 days of it falling due.
- 7.3 If the Buyer is paying for Goods on a "pro-forma" basis (whether due to slow payment or otherwise) no discount to the price stated in the Company's price list will apply notwithstanding any prior arrangement to the contrary unless the discount is confirmed by a director of the Company in writing.
- 7.4 The Company reserves the right, by giving notice to the Buyer to increase the price of the Goods to reflect any increase in the cost to the Company which is due to any factor beyond the control of the Company, any change in delivery dates or quantities specified by the Buyer or any delay caused by the instructions of the Buyer or failure of the Buyer to provide adequate information or instructions.
- 7.5 The price for the Goods shall be exclusive of any value added tax which shall be paid at the rate and in the manner for the time being provided by law.
- 7.6 Carriage will be paid by the Company on Goods bought in accordance with its current conditions for delivery on the UK mainland. Further charges may apply where alternative delivery terms are agreed.
- 7.7 A handling charge of £5.50 will be added to orders with a Goods value of less than the current minimum order value stipulated by the Company's sales office from time to time.
- 7.8 Invoices credited as a result of Buyer error will attract a service charge of 15% if returned within 21 days. Between 22 days and 3 months a charge of 30% will apply.

8. PAYMENT

- 8.1 The price for Goods is due within 30 days of the end of the month in which it is invoiced unless specified differently on the invoice. Time for payment shall be of the essence.
- 8.2 No payment shall be deemed to have been received until the Company has received cleared funds.
- 8.3 All payments payable to the Company under the Contract shall become due immediately upon termination of this Contract despite any other provision.
- 8.4 The Buyer shall make all payments due under the Contract without any deduction whether by way of set-off, counterclaim, discount, abatement or otherwise unless the Buyer has a valid court order requiring an amount equal to such deduction to be paid by the Company to the Buyer.
- 8.5 If the Buyer fails to pay the Company any sum due pursuant to the Contract the Buyer will be liable to pay interest to the Company on such sum from the due date for payment at the annual rate of 5% above the base lending rate published from time to time by the Bank of England, accruing on a daily basis until payment is made, whether before or after any judgment.

9. QUALITY

- 9.1 The Company warrants that (subject to the other provisions of these Conditions) upon delivery, the Goods will be of satisfactory quality within the meaning of the Sale of Goods Act 1979.
- 9.2 The Company shall not be liable for a breach of the warranty in Condition 9.1 unless: the Buyer gives written notice of the defect to the Company, and (if the defect is as a result of damage in transit) to the carrier, within 14 days of delivery; and the Company is given a reasonable opportunity after receiving the notice of examining such Goods and the Buyer (if asked to do so by the Company) returns such Goods to the Company's place of business at the Buyer's expense for the examination to take place.
- 9.3 The Company shall not be liable for a breach of the warranty in Condition 9.1 if the Buyer makes any further use of such Goods after giving such notice; or the defect arises because the Buyer failed to follow the Company's oral or written instructions as to the storage, installation, commissioning, use or maintenance of the Goods or (if there are none) good trade practice; or the Buyer alters or repairs such Goods without the written consent of the Company.
- 9.4 Subject to Conditions 9.2 and 9.3, if any of the Goods do not conform with the warranty in Condition 9.1 the Company shall at its option repair or replace such Goods (or the defective part) or refund the price of such Goods at the pro rata Contract rate provided that, if the Company so requests, the Buyer shall, at the Buyer's expense, return the Goods or the part of such Goods which is defective to the Company.
- 9.5 If the Company complies with Condition 9.4 it shall have no further liability for a breach of the warranty in Condition 9.1 in respect of such Goods.
- 9.6 Where a defect is discovered the Buyer will inform the Company immediately notwithstanding the expiry of the warranty period in Condition 9.2.

10. LIMITATION OF LIABILITY (The Buyer's attention is drawn to the provisions of this Condition)

- 10.1 Subject to Condition 9, the following provisions of this Condition 10 set out the entire financial liability of the Company (including any liability for the acts or omissions of its employees, agents and sub-contractors) in respect of any breach of these Conditions and any representation, statement or tortious act or omission including negligence arising under or in connection with the Contract.
- 10.2 All terms implied by statute or common law (save for the conditions implied by section 12 of the Sale of Goods Act 1979) are, to the fullest extent permitted by law, excluded from the Contract.
- 10.3 Nothing in these Conditions excludes or limits the liability of the Company for death or personal injury caused by the Company's negligence or for fraudulent misrepresentation.
- 10.4 Subject to Conditions 10.2 and 10.3:
- 10.4.1 the Company's total liability in contract, tort (including negligence or breach of statutory duty), misrepresentation or otherwise, arising in connection with the performance or contemplated performance of this Contract shall be limited to the price paid by the Buyer; and
- 10.4.2 the Company shall not be liable to the Buyer for any indirect or consequential loss or damage (whether for loss of profit, loss of business, depletion of goodwill or otherwise), costs, expenses or other claims for consequential compensation (howsoever caused) which arise out of or in connection with the Goods.
- 10.5 The Buyer warrants that any installation of the Goods will be performed by properly trained staff and agrees that it shall be solely responsible for any use to which the Goods are put after delivery.

11. INTELLECTUAL PROPERTY

- 11.1 The property and any copyright or other intellectual property rights in any Buyer Materials shall belong to the Buyer and any Company Materials shall, unless otherwise agreed in writing between the Buyer and the Company, belong to the Company, subject only to a licence in favour of the Buyer to use the Company Materials for the purposes of receiving the Goods.

12. FORCE MAJEURE

- 12.1 The Company reserves the right to defer the date of delivery or to cancel the Contract or reduce the volume of the Goods ordered by the Buyer (without liability to the Buyer) if it is prevented from or delayed in the carrying on of its business due to circumstances beyond the reasonable control of the Company including, without limitation, acts of God, governmental actions, war or national emergency, riot, civil commotion, fire, explosion, flood, epidemic, lock-outs, strikes or other labour disputes (whether or not relating to either party's workforce), or restraints or delays affecting carriers or inability or delay in obtaining supplies of adequate or suitable materials.
13. GENERAL
- 13.1 Each right or remedy of the Company under the Contract is without prejudice to any other right or remedy of the Company whether under the Contract or not.
- 13.2 If any provision or part of a provision of the Contract is found by any court or other body of competent jurisdiction to be illegal, invalid, void, voidable, unenforceable or unreasonable it shall be deemed severable and the remaining provisions of the Contract and the remainder of such provision shall continue in full force and effect.
- 13.3 Failure or delay by the Company in enforcing or partially enforcing any provision of the Contract will not be construed as a waiver of any of its rights under the Contract. Any waiver by the Company of any breach of, or any default under, any provision of the Contract by the Buyer will not be deemed a waiver of any subsequent breach or default and will in no way affect the other terms of the Contract.
- 13.4 The parties to this Contract do not intend that any term of this Contract will be enforceable by virtue of the Contracts (Rights of Third Parties) Act 1999 by any person that is not a party to it.
- 13.5 The Buyer shall not be entitled to assign the Contract or any part of it without the prior written consent of the Company. The Company may assign the Contract or any part of it to any person, firm or company.
- 13.6 The formation, existence, construction, performance, validity and all aspects of the Contract shall be governed by English law and the parties submit to the exclusive jurisdiction of the English courts.



Collingwood Lighting

Brooklands House, Sywell Aerodrome
Sywell Northampton, NN6 0BT

t +44 (0) 1604 495 151

f +44 (0) 1604 495 095

e sales@collingwoodgroup.com

w collingwoodlighting.com

Published April 2020 - Edition26



Join Collingwood Lighting on social media



CAT UK 2020