

LYOPRO

PRIME

OUTDOOR

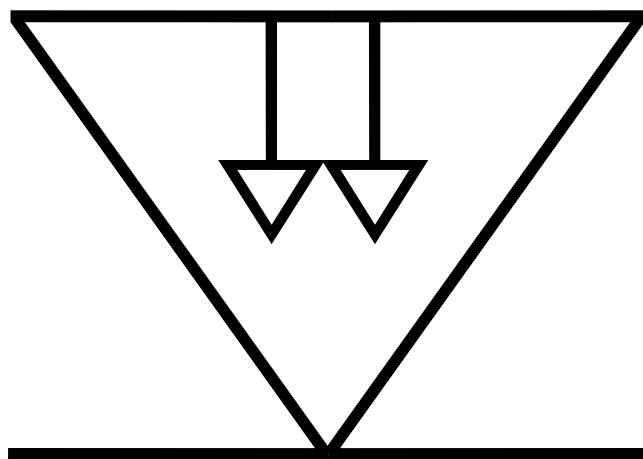

LYOPRO

PRIME

Lighting with you

5 YEARS
WARRANTY

Lyopro garantiza que sus productos están libres de cualquier defecto de fábrica y/o material siempre que se utilicen para los fines previstos, por un periodo de 5 años a partir de la fecha de facturación.



Índice de productos	4
Servicio de proyectos LYOPRO	6
Cómo leer nuestro catálogo	8
Luminarias subacuáticas	10
Luminarias de suelo	20
Luminarias empotrables	31
Luminarias de superficie	48
Luminarias de techo	104
Luminarias suspensión	121
Bolardos	138
Proyectores y proyectores de columna	184
Fuentes de alimentación	235
Dispositivos de control DMX	237
Información fotométrica	240
Símbolos	241
Condiciones de venta	242

LUMINARIAS
SUBACUÁTICAS



11 - DANA

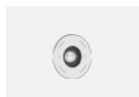

14 - CELIA

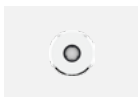

17 - KELLY

LUMINARIA DE SUELO



21 - HARPER



25 - CONNOR



28 - CANDY

LUMINARIAS
EMPOTRABLES



32 - NORA

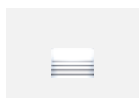

34 - LEXI



37 - ROXI



40 - INDIA



44 - MICA

LUMINARIAS DE
SUPERFICIE



49 - MAGNUS

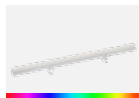

53 - MORGAN



57 - DAISY



61 - AMERY



64 - VELMA

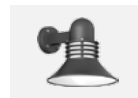

68 - GIA



72 - MARLON



75 - PAYTON

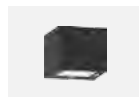

79 - PIPER



82 - KORA



84 - GARRET



88 - NEAL



91 - HESTER

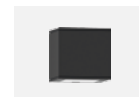

94 - HUNTER

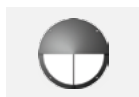

97 - NALA



100 - VALDUS

LUMINARIAS DE TECHO



105 - GARRET



108 - TAKEO



111 - WINTER



115 - TALA



118 - TESSA

LUMINARIAS DE
SUSPENSIÓN



122 - DAISY



125 - VELMA



128 - GIA



131 - PAYTON



135 - GARRET

BOLARDOS



**PROYECTORES Y
PROYECTORES DE
COLUMNA**

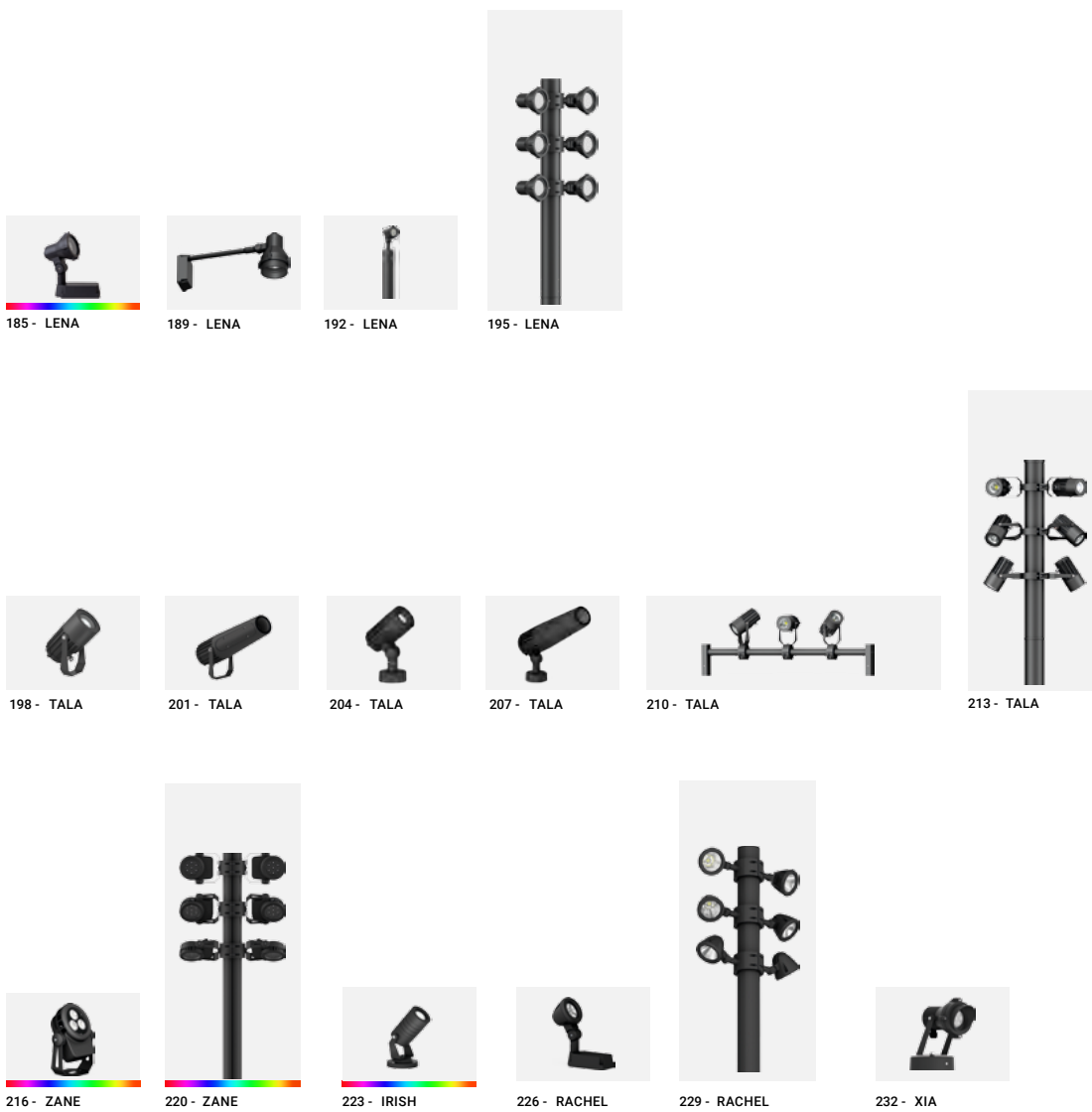

**FUENTES DE
ALIMENTACIÓN**





LYOPRO, es una empresa joven y dinámica que da mucha importancia a la luz tanto en interiores como en exteriores.

Realizamos proyectos de iluminación mediante un completo estudio lumínico tras conversación con el equipo de trabajo (**distribución sobre plano, fotomontajes, cálculos lumínicos, renderizados y 3D**), ajustándonos a las necesidades tanto económicas como estéticas, aportando ideas innovadoras y creativas para conseguir que la luz forme parte de la decoración.

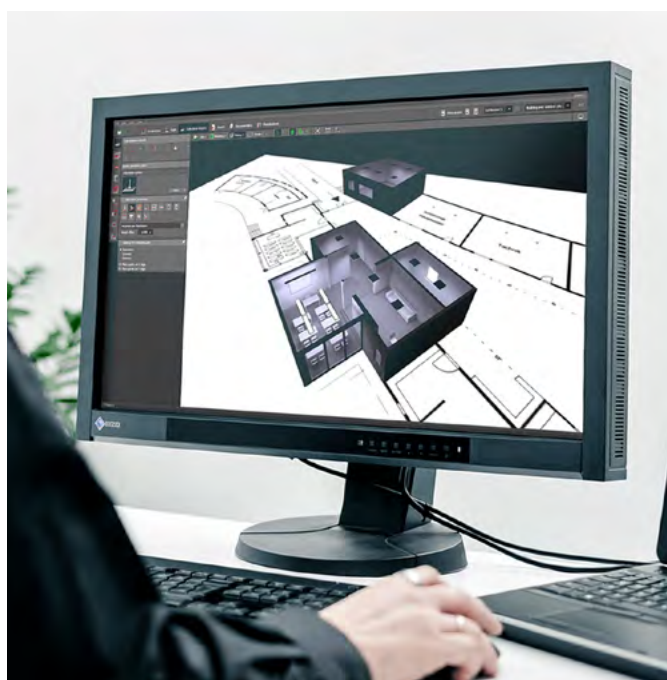

Minucioso seguimiento a pie de obra, estableciendo reuniones con los profesionales para garantizar los resultados.

SERVICIO DE PROYECTOS

LYOPRO, incorpora a sus proyectos nuevos diseños, acabados, rendimientos, ópticas, etc, todo ello destinado a satisfacer las necesidades creadas por los técnicos a la hora de proyectar alumbrado exterior, siempre bajo unos estrictos controles de calidad, tanto en el material como en las fuentes de luz. Generando luminarias con altas prestaciones además de un elevado grado de conanza en su fabricación, emitiendo coberturas de garantías para su luminarias de entre 5 y 10 años.

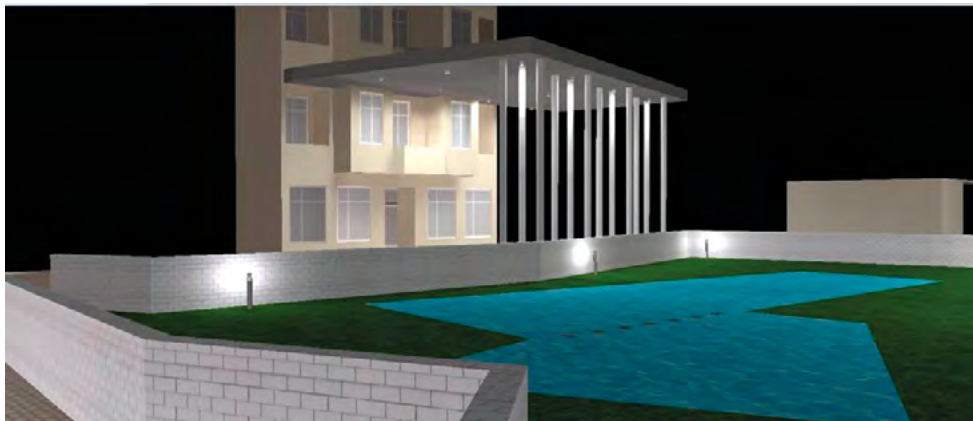

Todas nuestras luminarias cuentan con toda la información fotométrica necesaria para la realización de cualquier proyecto lumínico.

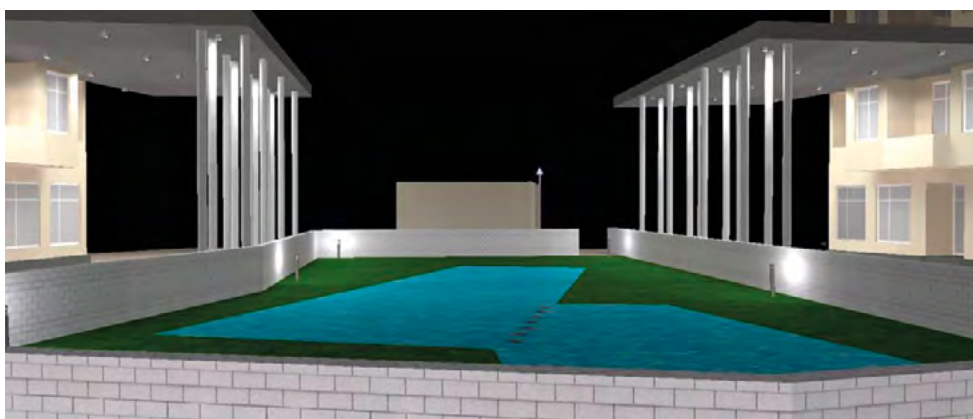

LYOPRO, con este movimiento se pone a la vanguardia en el mundo del **OUTDOOR**, para su desarrollo contamos con un departamento técnico además de un equipo comercial formado y a disposición del cliente para solventar cualquier consulta que surja en el día a día.

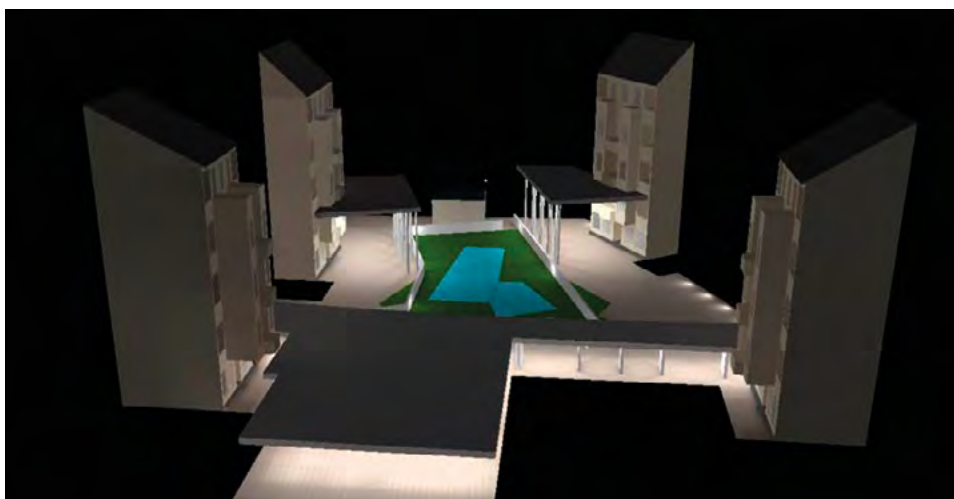

Cómo leer nuestro catálogo

El objetivo de los gráficos presentados a continuación es simplificar la lectura y facilitar la selección de productos. La composición del código de producto, al introducir las diferentes variables, permite reducir la exposición del código y mostrar toda la familia de productos. A continuación se muestra los detalles que se encuentran dentro del catálogo.

1. Descripción de la familia de productos.
2. Este área presenta pruebas realizadas y estancares IEC, es decir, valores IK e IP de la luminaria.
3. Área dedicada a los colores disponibles para la familia de productos con el código de color que se insertará a la hora de realizar la composición del código.

Nuestros colores son:

- Negro (01 RAL 9011)
- Gris Oscuro (02 RAL 7043)
- Blanco (03 RAL 9003)
- Plata mate (05 RAL 9006)
- Bronce (06 RAL 6014)

• Para otros colores RAL solicite presupuesto y plazo de entrega.

4. Descripción técnica y características de los materiales de la familia de producto.
5. Distribución del haz de luz disponible para cada familia de producto.
6. Muestra de la guía del código de producto.
7. Características del producto: código del producto, número de fuentes de luz LED, potencia del sistema, lumens de la luminaria, clasificación de coeficiente energético, peso, opciones de ópticas, CCT y opciones de regulación.
8. Imágenes del producto.
9. Dibujo técnico del producto.
10. Diagrama de ingeniería técnica dedicados a un código específico compuesto por un diagrama polar y la iluminación del haz y/o los diagramas de isolux.

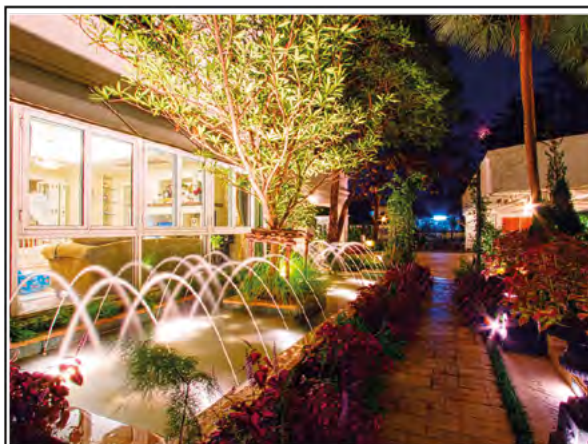

4

Estructura de luminaria

- Cuerpo y cierre de acero inoxidable engrado 316
- Entrada de cableónica
- Junta de goma de silicona blanca
- Vidrio templado transparente
- Profundidad máxima 2 metros
- La luminaria debe estar sumergida cuando está operativa
- Se incluye controlador remoto
- Incluye de IP empuja a la luz incluida
- El cable exterior debe ir acompañado con un Kingfisher específico

5

Símbolos de funciones

Símbolos de luz

2

1

Luzes subacuáticas auriculares, señalizaciones y ventiladores. Diseñados para ofrecer simplicidad y flexibilidad y construido para durar en cualquier entorno.

DANA
Proyectores subacuáticos

3

Código de color de luminaria

www.lyopro.es

6

DANA - Proyector subacuático

7

Código	Optica	Potencia	Lumen	EIC	Peso	M	W	A	EET	Electrónica	
Catálogo de control remoto - 50' cable IP para remoto											
DANA 1	7000	31,5D	8 W	300 - 770 lm	A+	1,1 kg	28°	32°	11°	W 30 - 40	NO - ON - ON
DANA 2	7001	7,1LD	12 W	530 - 1730 lm	A+	1,3 kg	22°	36°	12°	W 30 - 40	NO - ON - ON

8

9

10

DANA 2 - 7001 - W30 ALM W

www.lyopro.es

Opciones CCT y CRI

Simplificamos nuestro proceso de documentación para ofrecer 3000K y 4000K como opciones estándar para el catálogo, pero 2700K está disponible para todos los productos a pedido.

Si su proyecto necesita un CCT diferente y / o un CRI diferente, solicítelo y nuestro equipo técnico podrá brindarle asistencia en muy poco tiempo.

Opciones de acabado estándar

LYOPRO ofrece hasta cinco opciones de acabado de pintura en polvo de alta resistencia a la corrosión estándar que se pueden consultar en las páginas principales del producto y cuyo código se puede agregar a los códigos de producto estándar como se describe.

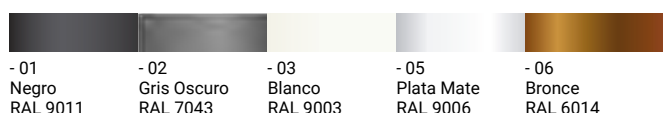

Opciones de acabado especiales

Sin embargo, LYOPRO, además de estos colores estándar, puede ofrecer muchas más opciones de color que se pueden solicitar a través de su contacto de ventas local para pedidos especiales. Estos colores y acabados especiales son los que se describen en la siguiente tabla:

Verde Beige RAL 1000 Suave	Blanco Ostra RAL 1013 Suave	Marfil claro RAL 1015 Suave	Amarillo RAL 1021 Suave	Beige Perla RAL 1035 Suave	Rojo púrpura RAL 3004 Suave	Rojo tráfico RAL 3020 Suave
Ultramarino RAL 5002 Suave	Musgo Verde RAL 6005 Texturizado	Oliva negro RAL 6015 Texturizado	Turquesa Gn RAL 6016 Suave	Monótono RAL 6022 Texturizado	Gris ardilla RAL 7000 Suave	Gris plateado RAL 7001 Suave
Gris Ratón RAL 7005 Suave	Gris hierro RAL 7011 Suave	Pizarra gris RAL 7015 Suave	Antracita RAL 7016 Suave / Texturizado	Gris oscuro RAL 7021 Texturizado	Gris Umbrá RAL 7022 Suave	Grafito RAL 7024 Suave
Gris granito RAL 7026 Suave	Gris azulado RAL 7031 Suave	Gris guijarro RAL 7032 Suave	Gris claro RAL 7035 Texturizado	Platino RAL 7036 Suave	Gris polvoriento RAL 7037 Suave / Texturizado	Ventana gris RAL 7040 Suave
Gris tráfico RAL 7042 Texturizado	Gris tráfico B RAL 7043 Suave	Telegrey RAL 7045 Suave	Perla gris RAL 7048 Suave / Texturizado	Marrón arcilla RAL 8003 Suave	Marrón cobre RAL 8004 Texturizado	Castaña RAL 8015 Suave
Chocolate RAL 8017 Suave	Gris marrón RAL 8019 Suave	Terra Brown RAL 8028 Texturizado	Crema RAL 9001 Suave	Gris blanco RAL 9002 Texturizado	Señal negro RAL 9004 Suave / Texturizado	Negro azabache RAL 9005 Suave / Texturizado
Aluminio gris RAL 9007 Suave	Blanco puro RAL 9010 Suave	Negro grafito RAL 9011 Texturizado	Blanco tráfico RAL 9016 Suave	Gris claro perla RAL 9022 Texturizado	Corten Efecto óxido Suave	

LUMINARIAS SUBACUÁTICAS



DANA
página 11



CELIA
página 14



KELLY
página 17



Luces subacuáticas ajustables, simples y rentables.
Diseñado para simplicidad y flexibilidad y construido
para durar en cualquier entorno.



Código de color de luminaria



- 00
Acero
Inoxidable



Estructura de luminaria

- Cuerpo y cierres de acero inoxidable en grado 316
- Entrada de cable única
- Junta de goma de silicona duradera
- Vidrio templado transparente
- Profundidad máxima 2 metros
- La luminaria debe estar sumergida cuando esté operativa
- Se incluye controlador remoto
- La caja de IP remota no está incluida
- El cable exterior debe pedirse con una longitud específica.

Símbolos de funciones



Símbolos de luz

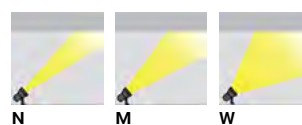

DANA Proyectores subacuáticos

Guia código producto 70000 - N - W30 - DI - 00 Óptica CCT Tipo Dimm Color Luminaria	Temperatura W30 - 3000K W40 - 4000K	Tipo Regulación ND - No dimmable DI - Dimmable 1-10V DA - Dimmable DALI	Color Luminaria 00 - Acero inox
--	---	--	------------------------------------

	Código	Chips	Potencia	Lumen	EEC	Peso	Óptica			CCT	Electrónica
							N	M	W		
Con driver de control remoto - Sin caja IP para remoto											
DANA 1	70000	3 LED	8 W	506 - 779 lm	A+	1.1 kg	28°	32°	51°	W 30 40	ND DI DA
DANA 2	70001	7 LED	12 W	1240 - 1726 lm	A++	1.1 kg	23°	34°	42°	W 30 40	ND DI DA

Caja IP65 para remoto 79000	Conector rápido IP68 10954
DANA 1	•
DANA 2	•



DANA 1

DANA 2

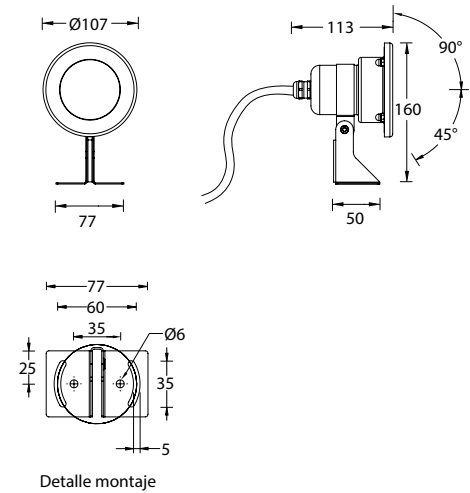

DANA 2, 70001-W30: N/M/W

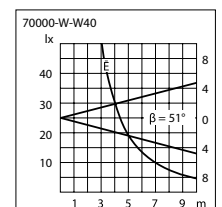
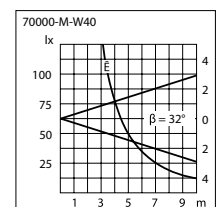
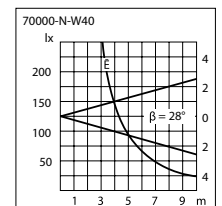



Gama de luminarias subacuáticas compacta y económica.
Accesorios empotrados de calidad competitiva y flexible
con múltiples ángulos de haz de luz.



CELIA

Proyectores subacuáticos

Código de color de luminaria



-00
Acero
Inoxidable



Estructura de Luminaria

- Cuerpo y cierres de acero inoxidable en grado 316
- Entrada de cable única
- Junta de goma de silicona duradera
- Vidrio templado transparente
- La luminaria debe estar sumergida cuando esté operativa
- Profundidad máxima 2 metros
- Se incluye caja de empotrar en polietileno de alta densidad
- Se incluye controlador remoto
- La caja de IP remota no está incluida
- El cable exterior debe pedirse con una longitud específica.

Símbolos de funciones



Símbolos de luz

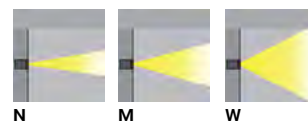

CELIA Proyectores subacuáticos

Guía código producto

70010 - N - W30 - DI - 00

Óptica

CCT

Tipo Dimm

Color Luminaria

Temperatura

W30 - 3000K

W40 - 4000K

Tipo Regulación

ND - No dimmable



DI - Dimmable 1-10V

DA - Dimmable DALI

Color Luminaria

00 - Acero inox

	Código	Chips	Potencia	Lumen	EEC	Peso	Óptica			CCT	Electrónica
							N	M	W		
Con caja de empotrar / driver control remoto - Sin caja IP para remoto											
CELIA 1	70010	3 LED	8 W	506 - 779 lm	A+	1.6 kg	28°	32°	51°	W 30 40	ND DI DA
CELIA 2	70011	7 LED	12 W	1240 - 1726 lm	A++	1.6 kg	23°	34°	42°	W 30 40	ND DI DA

	
Caja IP65 para remoto 79000	Conector rápido IP68 10954
CELIA 1	•
CELIA 2	•

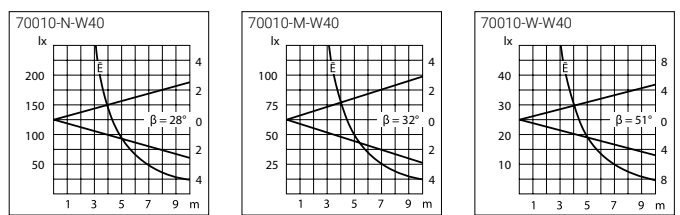
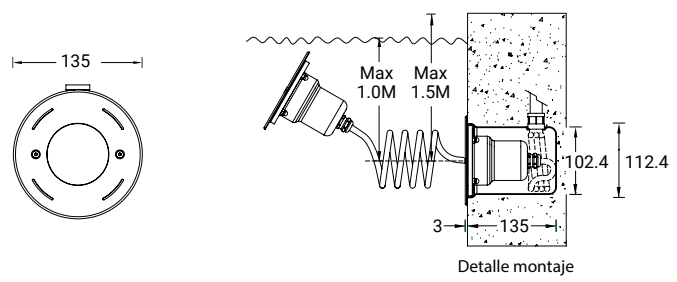

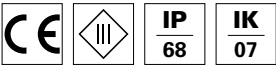

Familia potente de proyectores ajustables subacuáticos.
Ofrece soluciones incluso para las funciones acuáticas más complejas.



Código de color de luminaria



- 00
Acero
Inoxidable



Estructura de Luminaria

- Cuerpo y cierres de acero inoxidable en grado 316
- Entrada de cable única
- Junta de goma de silicona duradera
- Vidrio templado transparente
- La luminaria debe estar sumergida cuando esté operativa
- Profundidad máxima 1 metro
- Se incluye caja de empotrar en polietileno de alta densidad
- El controlador remoto no está incluido
- La caja de IP remota no está incluida
- El cable exterior debe pedirse con una longitud específica.

Símbolos de funciones



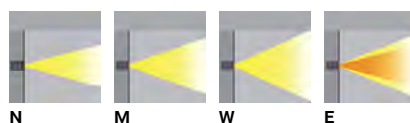

Símbolos de luz



KELLY Proyectores subacuáticos

Guía código producto 70020 - N - W30 - ND - 00 <div style="display: flex; justify-content: space-around; align-items: center;"> <div style="border: 1px solid black; padding: 2px;">Óptica</div> <div style="border: 1px solid black; padding: 2px;">CCT</div> <div style="border: 1px solid black; padding: 2px;">Tipo Dimm</div> <div style="border: 1px solid black; padding: 2px;">Color Luminaria</div> </div>	Temperatura W30 - 3000K W40 - 4000K 30 - RGBW 3000K 40 - RGBW 4000K	Tipo Regulación ND - No dimmable DI - Dimmable 1-10V DA - Dimmable DALI	Color Luminaria 00 - Acero inox
---	--	---	---

Código	Chips	Potencia	Lumen	EEC	Peso	Óptica				CCT	Electrónica	
						N	M	W	E			
Con caja empotrable - Sin controlador remoto / caja IP - Voltaje constante (CV) 24V												
KELLY 1	70020	1 LED	2 W	143 - 145 lm	A++	0.6 kg	23°	-	-	-	W 30 40	ND DI DA
Con caja empotrable - Sin controlador remoto - Voltaje constante (CV) 24V - RGBW												
KELLY 2	70021	1 LED	5 W	202 - 227 lm	A	0.6 kg	18°	33°	50°	23°x43°	30 40	DMX

	
Connector IP68	Caja IP65 para remoto
10954	79000
70020	•
70021	•

*79000 = 60x200x40 mm



KELLY 1

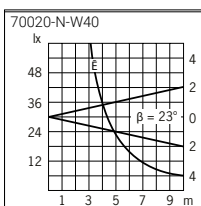
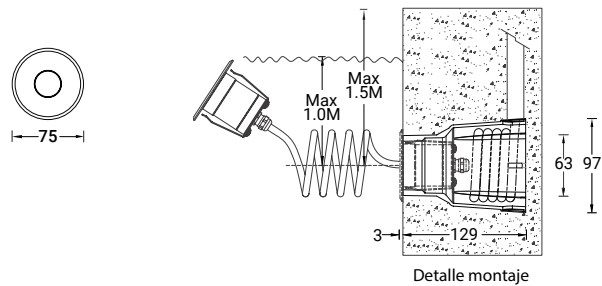

LUMINARIAS DE SUELO



HARPER
página 21



CONNOR
página 25



CANDY
página 28



Acanto y reflector completos, flexibles y competitivos de suelo.
La familia líder en el sector de la iluminación de calidad a bajo
costo en accesorios de suelo.

HARPER

Luminarias de suelo

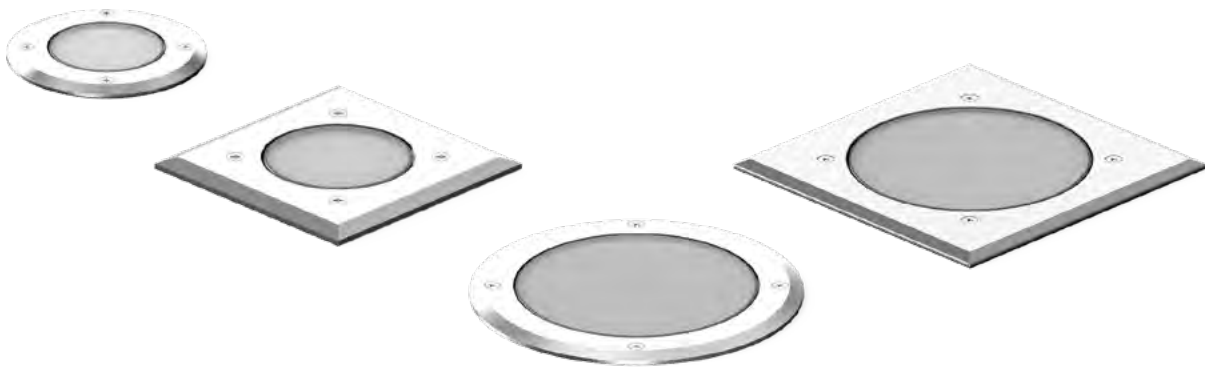

Código de color de luminaria

-00	-01	-02	-03	-05	-06
Acero Inoxidable	Negro	Gris Oscuro	Blanco	Plata Mate	Bronce
	RAL 9011	RAL 7043	RAL 9003	RAL 9006	RAL 6014



Estructura de Luminaria

- Carcasa de aluminio fundido a presión pretratada antes del recubrimiento en polvo que garantiza una alta resistencia a la corrosión
- Aro frontal de 6 mm de espesor en acero inoxidable o aluminio
- Entrada de cable única
- Mediante cableado bajo pedido
- Sujetadores de acero inoxidable en grado 316
- Lente de PMMA de alta eficiencia
- Junta de goma de silicona duradera
- Vidrio templado transparente de 10 mm de espesor
- Equipo de control integral
- Se incluye controlador remoto para 70031, 70032, 70035, 70036
- Se incluye caja de empotrar en polietileno de alta densidad
- Apto para caminar con una carga máxima de 200 kg

Símbolos de funciones





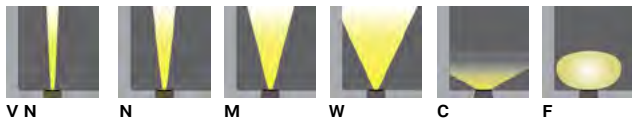



Símbolos de luz



HARPER Luminarias de suelo

Guía código producto	70030 - S - F - W30 - DI - 01	Marco	Óptica	CCT	Tipo Dimm	Color Luminaria	Marco S - Marco Inox A - Marco Aluminio	Temperatura del color W30 - 3000K W40 - 4000K	Tipo Regulación ND - No dimmable DI - Dimmable 1-10V DA - Dimmable DALI	Color Luminaria 00 - Acero inox 01 - Negro 02 - Gris Oscuro 03 - Blanco 05 - Plata Mate 06 - Bronce
							Óptica C - Difusor Transparente F - Difusor Opaco			

Código	Chips	Potencia	Lumen	EEC	Peso	Óptica								CRI	CCT	Electrónica	
						VN	N	M	N	W	E	C	F				
Con caja de empotrar / driver - Redondo																	
HARPER 1	70030	12 LED	6 W	163 - 291 lm	A++	0.5 kg	-	-	-	-	-	-	90°	78°	-	W 30 40	ND
	70033	MR16-GU10	7.5 W	260 - 402 lm	A	0.5 kg	-	13°	22°	-	58°	12°x50°	-	-	90	W 30 40	ND
HARPER 3	70040	9 LED	15 W	1183 - 1468 lm	A+	2.1 kg	-	15°	26°	40°	-	-	-	-	-	W 30 40	ND DI DA
	70041	18 LED	29 W	2387 - 2899 lm	A+	2.4 kg	-	15°	28°	41°	-	-	-	-	-	W 30 40	ND DI DA
	70038	12 LED	6 W	369 - 410 lm	A++	2.1 kg	-	-	-	-	-	-	95°	84°	-	W 30 40	ND DI DA
	70039	7 LED	33 W	2967 - 3187 lm	A+	2.1 kg	8°	-	-	-	-	-	-	-	-	W 30 40	ND DI DA
Con caja de empotrar / driver - Cuadrado																	
HARPER 2	70034	12 LED	6 W	163 - 291 lm	A++	0.5 kg	-	-	-	-	-	-	90°	78°	-	W 30 40	ND
	70037	MR16-GU10	7.5 W	260 - 402 lm	A	0.5 kg	-	13°	22°	-	58°	12°x50°	-	-	90	W 30 40	ND
HARPER 4	70044	9 LED	15 W	1183 - 1468 lm	A+	2.1 kg	-	15°	26°	40°	-	-	-	-	-	W 30 40	ND DI DA
	70045	18 LED	29 W	2387 - 2899 lm	A+	2.4 kg	-	15°	28°	41°	-	-	-	-	-	W 30 40	ND DI DA
	70042	12 LED	6 W	280 - 410 lm	A++	2.1 kg	-	-	-	-	-	-	95°	84°	-	W 30 40	ND DI DA
	70043	7 LED	33 W	2967 - 3187 lm	A+	2.1 kg	8°	-	-	-	-	-	-	-	-	W 30 40	ND DI DA
Con caja de empotrar / driver control remoto / caja IP control remoto - Redondo																	
HARPER 1	70031	3 LED	8 W	316 - 427 lm	A+	0.5 kg	-	20°	30°	50°	-	-	-	-	-	W 30 40	ND DI DA
	70032	1 LED	8 W	548 - 555 lm	A+	0.5 kg	8°	-	-	-	-	-	-	-	-	W 30 40	ND DI DA
Con caja de empotrar / driver control remoto / caja IP control remoto - Cuadrado																	
HARPER 2	70035	3 LED	8 W	316 - 427 lm	A+	0.5 kg	-	20°	30°	50°	-	-	-	-	-	W 30 40	ND DI DA
	70036	1 LED	8 W	548 - 555 lm	A+	0.5 kg	8°	-	-	-	-	-	-	-	-	W 30 40	ND DI DA

						
	Caja de empotrar	Caja de empotrar	Caja de empotrar	Cristal antideslizante	Connector IP68	Caja remota IP65
	70050	70051	70052	70053	10954	79000
70030	•					•
70033	•					•
70040		•		•		•
70041			•	•		•
70034	•					•
70037	•					•
70044		•		•		•
70045			•	•		•
70038		•				•
70039		•				•
70042		•		•		•
70043		•		•		•
70031	•					•
70032	•					•
70035	•					•
70036	•					•

HARPER Luminarias de suelo



HARPER 1

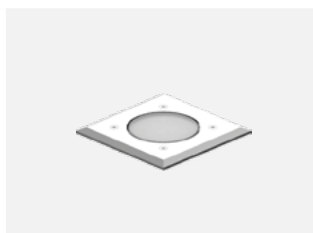

HARPER 2



HARPER 3

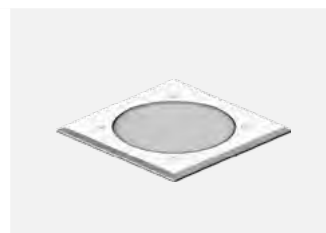

HARPER 4

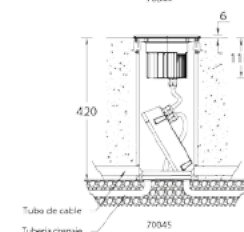
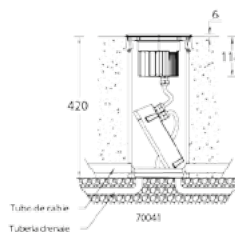
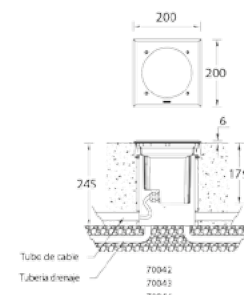
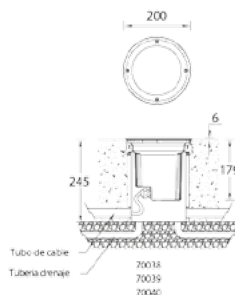
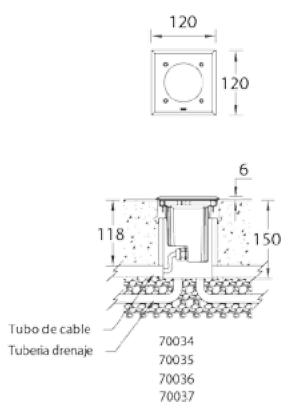
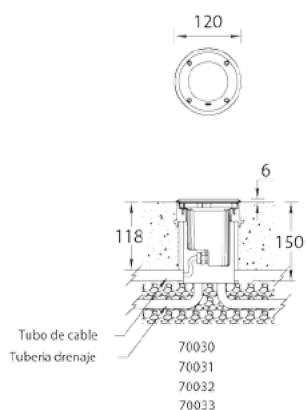

HARPER 1, 70031-W30
Ángulo: N/M/W (Setback 0.5m)

HARPER 1, 70030-W30
Ángulo: C/F

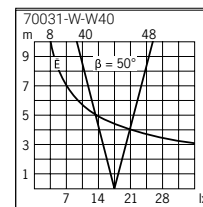
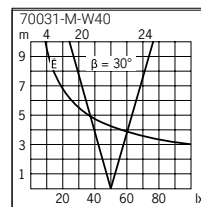
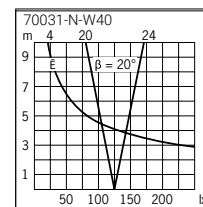
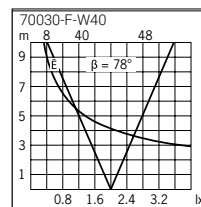
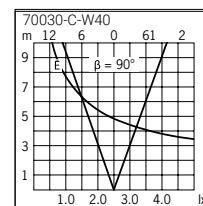
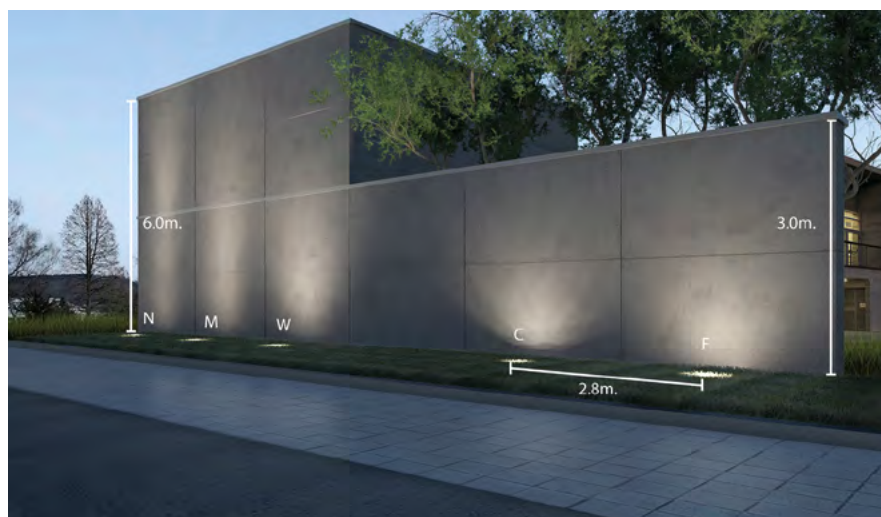



Luminarias de suelo semi-empotradas para caminar por encima o pasar con el coche. Resistente, de estética limpia, con múltiples direcciones de emisión de luz.

CONNOR

Luminarias de suelo



Código de color de luminaria

- 01	- 02	- 03	- 05	- 06
Negro	Gris Oscuro	Blanco	Plata Mate	Bronce
RAL 9011	RAL 7043	RAL 9003	RAL 9006	RAL 6014



Estructura de Luminaria

- Carcasa y marco de aluminio fundido a presión pretratados antes del recubrimiento en polvo que garantizan una alta resistencia a la corrosión
- Entrada de cable única
- Mediante cableado bajo pedido
- Sujetadores de acero inoxidable en grado 316
- Junta de goma de silicona duradera
- Lente de cristal transparente
- Equipo de control integral
- Se incluye caja de empotrar en polietileno de alta densidad
- Para asegurar un drenaje eficiente, se debe usar grava a una profundidad de 450 mm y un ancho de 300 mm debajo de la carcasa y también debe colocarse alrededor de la luminaria
- Apto para traspaso con una carga máxima de 4000 kg
- Los vehículos con neumáticos pueden pasar por encima de la luminaria pero la velocidad no debe superar los 10 km / h
- La carga es transferida por la carcasa a los cimientos.

Símbolos de funciones



Símbolos de luz



CONNOR Luminarias de suelo

Guía código producto

70060 - W30 - DI - 01

CCT Color Luminaria
Tipo Dimm

Temperatura del color
W30 - 3000K
W40 - 4000K

Tipo Regulación
ND - No dimmable
DI - Dimmable 1-10V
DA - Dimmable DALI

Color Luminaria
01 - Negro
02 - Gris Oscuro
03 - Blanco
05 - Plata Mate
06 - Bronce

Código	Chips	Potencia	Lumen	EEC	Peso	Óptica	CCT	Electrónica
							G	
Con caja de empotrar / driver - Distribucion 1 luz 90°								
CONNOR 1	70060	1 COB	4 W	104 - 112 lm	A++	4.4 kg	90°	W 30 40 ND DI DA
Con caja de empotrar / driver - Distribucion 2 luces 90°x90°								
CONNOR 2	70061	2 COB	8 W	202 - 220 lm	A++	4.5 kg	90°/ 90°	W 30 40 ND DI DA
Con caja de empotrar / driver - Distribucion 4 luces 360°								
CONNOR 3	70062	4 COB	15 W	402 - 433 lm	A++	4.4 kg	360°	W 30 40 ND DI DA
Con caja de empotrar / driver - Distribucion 2 luces 180°								
CONNOR 4	70063	2 COB	8 W	207 - 223 lm	A++	4.4 kg	180°	W 30 40 ND DI DA



Connector IP68
10954

70060	•
70061	•
70062	•
70063	•

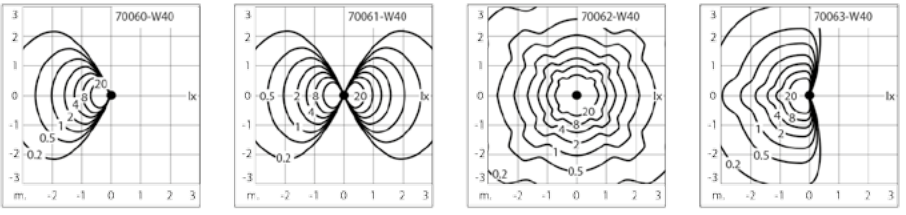
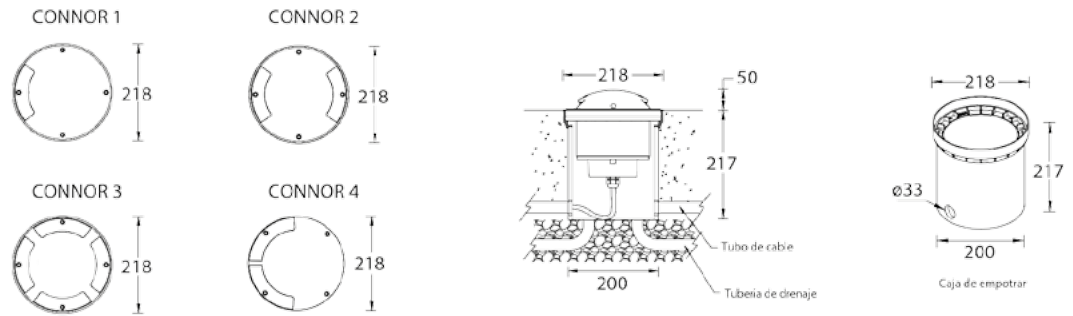
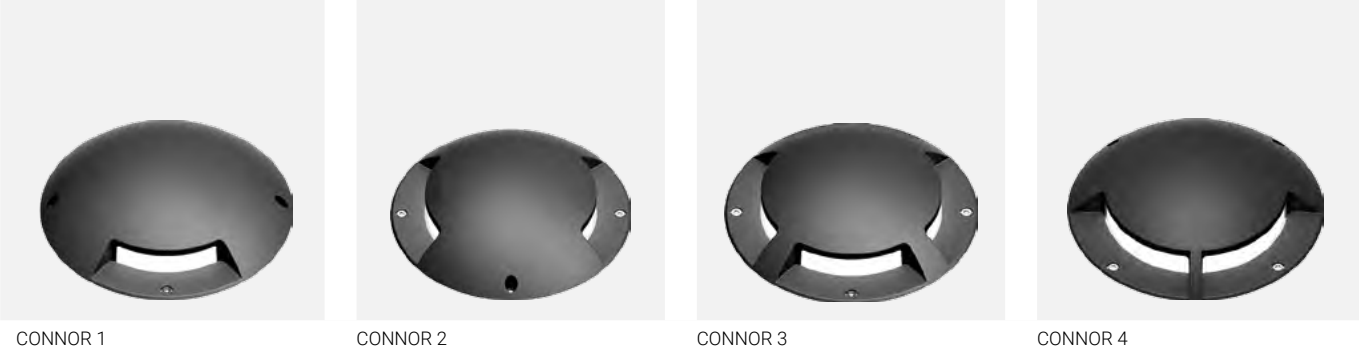

CANDY

Luminaria de suelo

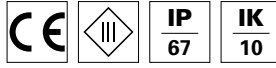

Luminarias de acentuación del suelo discreta, huella mínima.
Opciones de luz blanca o RGBW dinámico con accesorios de
conexión y sistemas de control.



Código de color de luminaria



-00
Acero
Inoxidable



Estructura de Luminaria

- Carcasa de aluminio fundido a presión pretratada antes del recubrimiento en polvo que garantiza una alta resistencia a la corrosión
- Aro frontal de acero inoxidable de 3 mm de espesor
- Entrada de cable única
- Una vez prensaestopas suministrado con 0,5 m de cable exterior de 2x0,5 mm²
- Junta de goma de silicona duradera
- Sujetadores de acero inoxidable en grado 316
- Vidrio templado transparente de 8 mm de espesor
- Apto para caminar con una carga máxima de 200 kg
- Para asegurar un drenaje eficiente, se debe usar grava a una profundidad de 450 mm y un ancho de 300 mm debajo de la carcasa y también debe colocarse alrededor de la luminaria
- El controlador remoto no está incluido
- Se incluye caja de empotrar en polietileno de alta densidad

Símbolos de funciones



Símbolos de luz

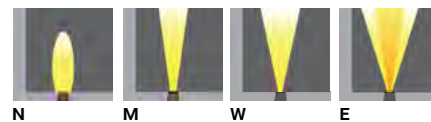

CANDY Luminarias de suelo

<p>Guía código producto</p> <p>70070 - N - W30 - DI - 00</p> <p> Óptica CCT Tipo Dimm Color Luminaria </p>	<p>Temperatura del Color</p> <p>W30 – 3000K W40 – 4000K 30 - RGBW 3000K 40 - RGBW 4000K</p>	<p>Tipo Regulación</p> <p>ND – No dimmable DI – Dimmable 1-10V DA – Dimmable DALI</p>	<p>Color Luminaria</p> <p>00 – Acero inox</p>
--	--	--	--

Código	Chips	Potencia	Lumen	EEC	Peso	Óptica				CCT	Electrónica	
						N	M	W	E			
Con caja de empotrar - sin driver control remoto - Voltaje Constante (CV) 24V												
CANDY 1	70070	1 LED	2 W	143 - 145 lm	A++	0.46 kg	23°	-	-	-	W 30 40	ND DI DA
Con caja de empotrar - sin driver control remoto - Voltaje Constante (CV) 24V - RGBW												
CANDY 2	70071	1 LED	5 W	202 - 227 lm	A+	0.46 kg	18°	33°	50°	23° x 43°	RGBW30 40	DMX

	Dispositivo control DMX	Dispositivo control DMX	Mando DMX	Conector IP68	Caja IP65 para remoto
	79100	79101	79102	10954	79000
70070	•	•	•	•	•
70071	•	•	•	•	•



CANDY

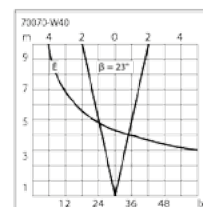
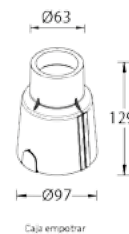
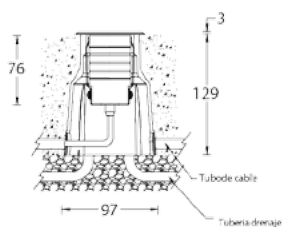

CANDY 1, 70070-W30 (Setback 0.1m)

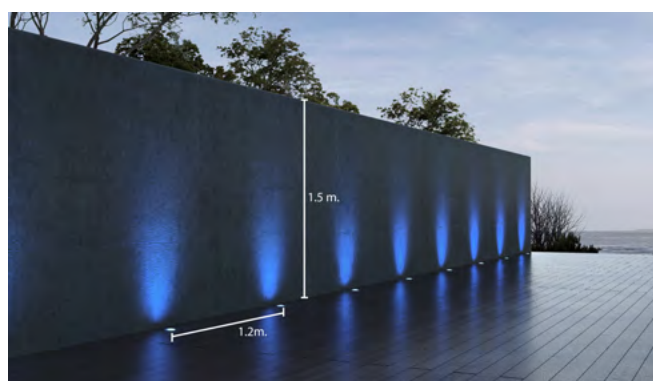

CANDY 2, 70071-RGBW30 (Setback 0.1m)

LUMINARIAS EMPOTRABLES



NORA
página 32



LEXI
página 34



ROXY
página 37



INDIA
página 40



MICA
página 44

NORA





Luminarias empotrable

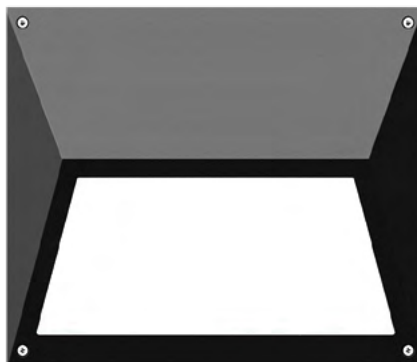

Muro urbano robusto de vía semi-empotrada y luminaria de escalera. Diseñado para ofrecer niveles de tarea de borde a borde a partir de un factor de forma clásico.



Código de color de luminaria

				
-01 Negro	-02 Gris Oscuro	-03 Blanco	-05 Plata Mate	-06 Bronce
RAL 9011	RAL 7043	RAL 9003	RAL 9006	RAL 6014

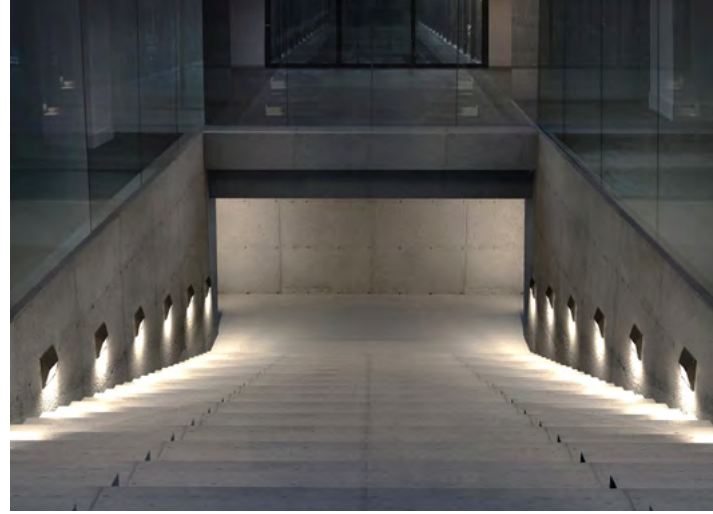

Estructura de Luminaria

- Carcasa de aluminio fundido a presión pretratada antes del recubrimiento en polvo que garantiza una alta resistencia a la corrosión
- Dos entradas de cable para cableado pasante
- Sujetadores de acero inoxidable en grado 316
- Junta de goma de silicona duradera
- Lente de extensión lineal endurecida
- Equipo de control integral

Símbolos de funciones



Símbolos de luz



G

<p>Guía código producto</p> <p>70080 - W30 - DI - 01</p> <p>CCT Color Luminaria</p> <p>Tipo Dimm</p>	<p>Temperatura del color</p> <p>W30 – 3000K</p> <p>W40 – 4000K</p>	<p>Tipo Regulación</p> <p>ND – No dimmable</p> <p>DI – Dimmable 1-10V</p> <p>DA – Dimmable DALI</p>	<p>Color Luminaria</p> <p>01 – Negro</p> <p>02 – Gris Oscuro</p> <p>03 – Blanco</p> <p>05 – Plata Mate</p> <p>06 – Bronce</p>
---	--	---	---

Código	Chips	Potencia	Lumen	EEC	Peso	Óptica	CCT	Electrónica	
						G			
Con caja de empotrar									
NORA 1	70080	3 COB	23 W	713 - 769 lm	A+	4.8 kg	61°x114°	W 30 40	ND DI DA



NORA 1

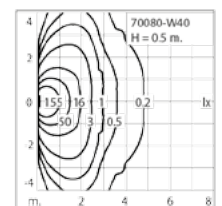
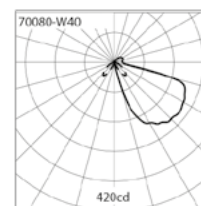
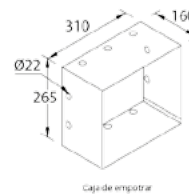
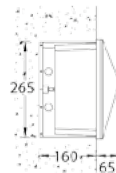
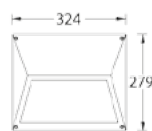



Accesorio de búsqueda de manera contemporánea para un confort visual sin destellos. Diseño sofisticado, con espacio mínimo y disponible con soluciones opcionales de sonido envolvente y suministro.



Código de color de luminaria

- 01 Negro	- 02 Gris Oscuro	- 03 Blanco	- 05 Plata Mate	- 06 Bronce
RAL 9011	RAL 7043	RAL 9003	RAL 9006	RAL 6014

Símbolos de funciones

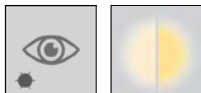

Símbolos de luz



G



Estructura de Luminaria

- Carcasa de aluminio fundido a presión pretratada antes del recubrimiento en polvo asegurando una alta resistencia a la corrosión
- Entrada de cable única
- Sujetadores de acero inoxidable en grado 316
- Junta de goma de silicona duradera
- Difusor de vidrio templado transparente
- Equipo de control integral para LEXI-1, LEXI-3
- El controlador remoto no está incluido para LEXI-2, LEXI-4
- Caja de empotrar / abrazadera de resorte incluida

LEXI 3, 70092-W30 Altura de montaje 0,5 m

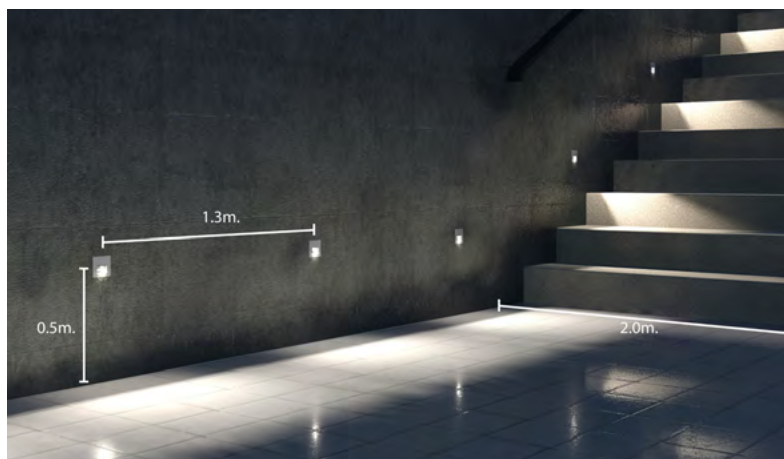

LEXI Luminarias empotrables

Guía código producto

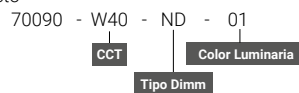

Temperatura del color
W30 - 3000K
W40 - 4000K

Tipo Regulación
ND - No dimmable
DI - Dimmable 1-10V
DA - Dimmable DALI

Color Luminaria
01 - Negro
02 - Gris Oscuro
03 - Blanco
05 - Plata Mate
06 - Bronce

Código	Chips	Potencia	Lumen	EEC	Peso	Óptica	CCT	Electrónica
Con caja de empotrar - Con driver - 230V - Clase I								
LEXI 1	70090	1 LED	4 W	39 lm	A++	0.3 kg	34° x 68°	W 30 40 ND
Con caja de empotrar - Sin driver control remoto - Voltaje Constante (CV) 24V - Clase III								
LEXI 2	70091	1 LED	2 W	39 lm	A++	0.3 kg	34° x 68°	W 30 40 ND DI DA
Con pinza de anclaje - Con driver - 230V - Clase I								
LEXI 3	70092	1 LED	4 W	39 lm	A++	0.3 kg	34° x 68°	W 30 40 ND
Con pinza de anclaje - Sin driver control remoto - Voltaje Constante (CV) 24V - Clase III								
LEXI 4	70093	1 LED	2 W	39 lm	A++	0.3 kg	34° x 68°	W 30 40 ND

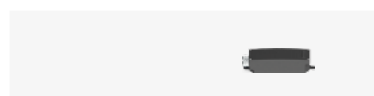

Caja IP65 para control remoto

79000

70091	•
70093	•



LEXI 1 Y 2



LEXI 3 Y 4

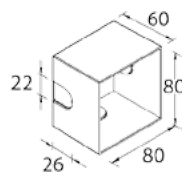
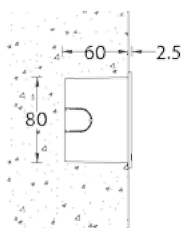
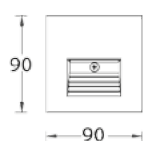

Caja de empotrar

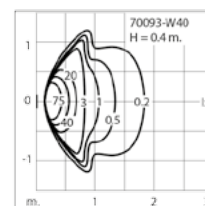
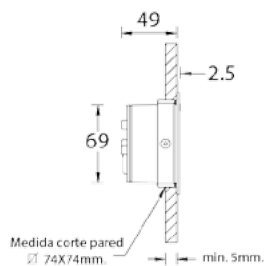
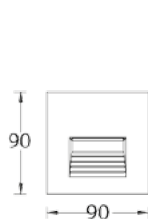
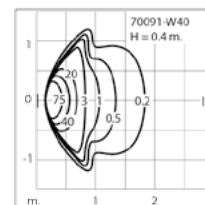

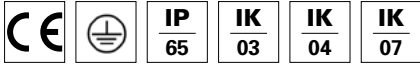

Rango acentuado de pared de época. Familia eficiente, flexible y resistente en las proporciones clásicas de ladrillo de luz.

ROXY

Luminarias empotrables



Código de color de luminaria

-00	-01	-02	-03	-05	-06
Acero Inoxidable	Negro	Gris Oscuro	Blanco	Plata Mate	Bronce
	RAL 9011	RAL 7043	RAL 9003	RAL 9006	RAL 6014



Estructura de Luminaria

- Disponible con marcos intercambiables de aluminio o acero inoxidable grado 316
- Carcasa de aluminio fundido a presión pretratada antes del recubrimiento en polvo que garantiza una alta resistencia a la corrosión
- Dos entradas de cable para cableado pasante
- Sujetadores de acero inoxidable en grado 316
- Junta de goma de silicona duradera
- Vidrio templado esmerilado
- Difusor de policarbonato opalino, resistente a los golpes y estabilizado a los rayos UV para 70105
- Equipo de control integral

Símbolos de funciones



Símbolos de luz

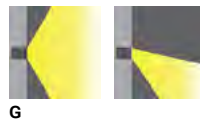

ROXI Luminarias empotrables

<p>Guía código producto</p> <p>70100 - S - W30 - DI - 01</p> <p>Marco CCT Color Luminaria Tipo Dimm</p>	<p>Marco</p> <p>S - Marco Inox</p> <p>A - Marco Aluminio</p>	<p>Temperatura del color</p> <p>W30 - 3000K</p> <p>W40 - 4000K</p>	<p>Tipo Regulación</p> <p>ND - No dimmable</p> <p>DI - Dimmable 1-10V</p> <p>DA - Dimmable DALI</p>	<p>Color Luminaria</p> <p>00 - Acero inox</p> <p>01 - Negro</p> <p>02 - Gris Oscuro</p> <p>03 - Blanco</p> <p>05 - Plata Mate</p> <p>06 - Bronce</p>
---	--	--	---	--

Código	Chip	Potencia	Lumen	EEC	Peso	Óptica	CCT	Electrónica	
						G			
Con caja de empotrar - Marco de aluminio - IK03									
ROXY 1	70100-A	3 COB	11 W	389 - 399 lm	A++	2.3 kg	115°x180°	W 30 40	ND DI DA
Con caja de empotrar - Marco de aluminio - IK04									
ROXY 1	70101-A	3 COB	11 W	389 - 420 lm	A++	1.4 kg	96°x108°	W 30 40	ND DI DA
ROXY 4	70105-A	3 COB	11 W	320 - 345 lm	A++	1.6 kg	104°x110°	W 30 40	ND DI DA
Con caja de empotrar - Marco de aluminio - IK07									
ROXY 2	70102-A	3 COB	11 W	68 - 74 lm	A++	1.6 kg	65°x160°	W 30 40	ND DI DA
	70103-A	3 COB	11 W	56 - 60 lm	A++	2.4 kg	63°x113°	W 30 40	ND DI DA
ROXY 3	70104-A	3 COB	11 W	117 - 126 lm	A++	1.4 kg	86°x108°	W 30 40	ND DI DA
ROXY 5	70106-A	3 COB	11 W	106 - 114 lm	A++	1.6 kg	92°x54°	W 30 40	ND DI DA
Con caja de empotrar - Marco inoxidable - IK03									
ROXY 1	70100-S	3 COB	11 W	375 - 405 lm	A++	2.5 kg	115°x180°	W 30 40	ND DI DA
Con caja de empotrar - Marco inoxidable - IK04									
ROXY 1	70101-S	3 COB	11 W	389 - 420 lm	A++	1.7 kg	96°x108°	W 30 40	ND DI DA
Con caja de empotrar - Marco inoxidable - IK07									
ROXY 2	70102-S	3 COB	11 W	144 - 155 lm	A++	1.9 kg	65°x160°	W 30 40	ND DI DA
	70103-S	3 COB	11 W	95 - 103 lm	A++	2.7 kg	63°x113°	W 30 40	ND DI DA
ROXY 3	70104-S	3 COB	11 W	266 - 287 lm	A++	1.9 kg	86°x108°	W 30 40	ND DI DA

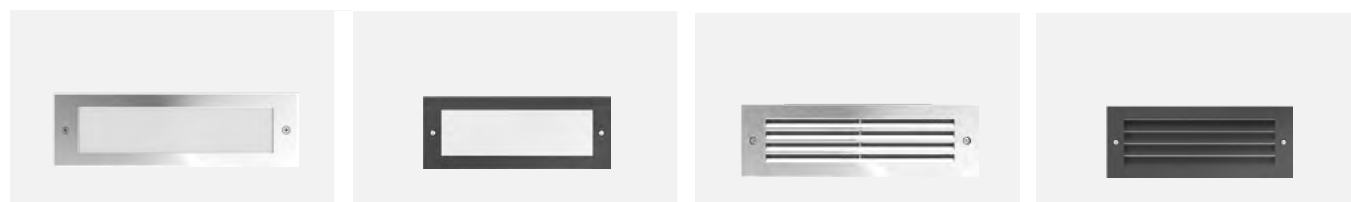

ROXY 1 MARCO INOX

ROXY 1 MARCO ALUMINIO

ROXY 2 MARCO INOX

ROXY 2 MARCO ALUMINIO

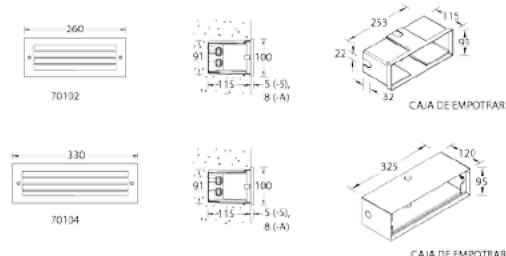
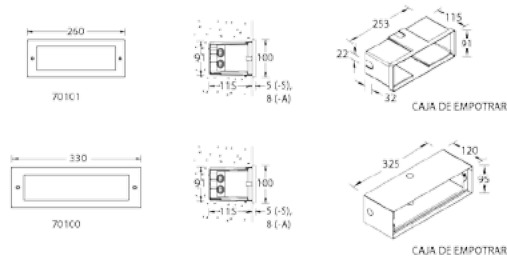

ROXY 3

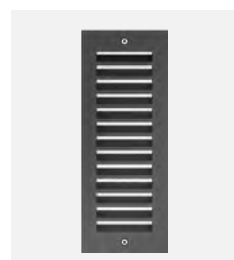
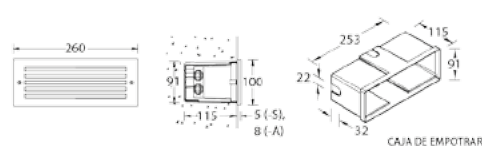

ROXY 5

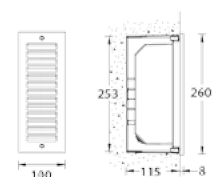

ROXY 4

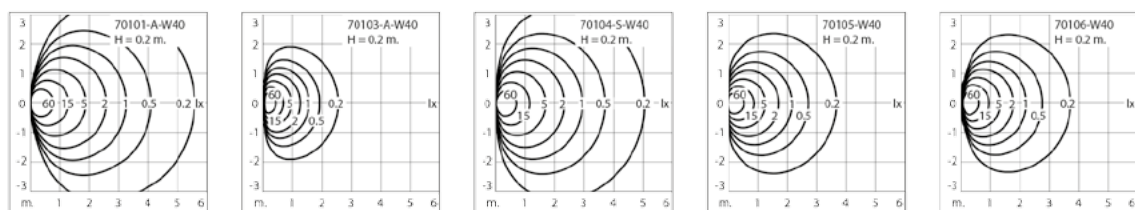
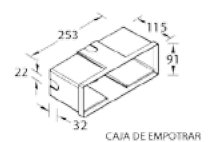
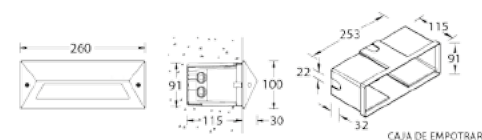

INDIA

Luminarias empotrables



Luminaria vía empotrada de pared clásica y luminaria de escalera. Estética simple y agradable, construcción robusta, perfecta para aplicaciones de adaptación con sus múltiples tamaños ofrecidos.



Código de color de luminaria

-00	-01	-02	-03	-05	-06
Acero Inoxidable	Negro	Gris Oscuro	Blanco	Plata Mate	Bronce
RAL 9011	RAL 7043	RAL 9003	RAL 9006	RAL 6014	



Estructura de Luminaria

- Carcasa de aluminio fundido a presión pretratada antes del recubrimiento en polvo que garantiza una alta resistencia a la corrosión
- Dos entradas de cable para cableado pasante
- Sujetadores de acero inoxidable en grado 316
- Junta de goma de silicona duradera
- Difusor de vidrio templado
- Equipo de control integral

Símbolos de funciones



Símbolos de luz



INDIA Luminarias empotrables

Guía código producto

70110 - W30 - DI - 01

CCT

Tipo Dimm

Color Luminaria

Temperatura del color

W30 - 3000K

W40 - 4000K

Tipo Regulación

ND - No dimmable

DI - Dimmable 1-10V

DA - Dimmable DALI

Color Luminaria

01 - Negro

02 - Gris Oscuro

03 - Blanco

05 - Plata Mate

06 - Bronce

Código	Chip	Potencia	Lumen	EEC	Peso	Óptica	CCT	Electrónica	
						G			
Con caja de empotrar									
INDIA 1	70110	1 COB	4 W	124 - 133 lm	A++	1.0 kg	36°x50°	W 30 40	ND
INDIA 2	70111	4 x 12 LED	17 W	558 - 620 lm	A++	1.2 kg	23°x94°	W 30 40	ND DI DA
INDIA 3	70112	3 x 12 LED	13 W	502 - 540 lm	A++	2.0 kg	50°x80°	W 30 40	ND DI DA
INDIA 4	70113	4 x 12 LED	27 W	768 - 853 lm	A+	4.0 kg	50°x75°	W 30 40	ND DI DA
INDIA 5	70114	4 x 12 LED	17 W	402 - 447 lm	A++	1.4 kg	32°x88°	W 30 40	ND DI DA
INDIA 6	70115	30 LED	11 W	438 - 471 lm	A++	2.5 kg	31°x88°	W 30 40	ND
INDIA 7	70116	1 COB	20 W	1382 - 1399 lm	A+	6.5 kg	42°x69°	W 30 40	ND DI DA
Con abrazadera de resorte									
INDIA 7	70117	1 COB	20 W	1382 - 1399 lm	A+	4.6 kg.	42°x69°	W 30 40	ND DI DA



INDIA 1

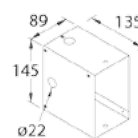
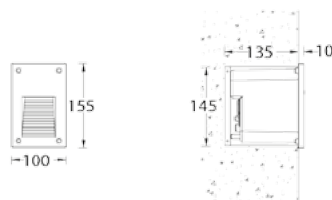

Caja de empotrar

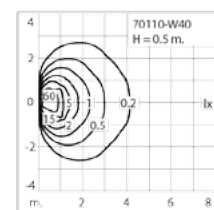

INDIA 2

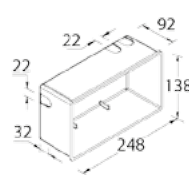
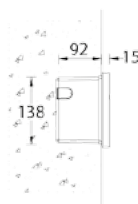
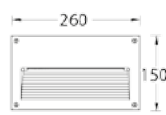

Caja de empotrar

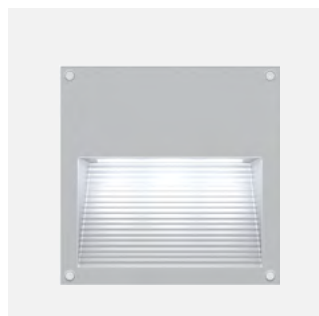
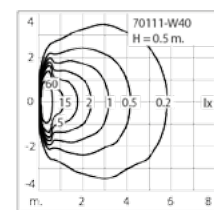

INDIA 3

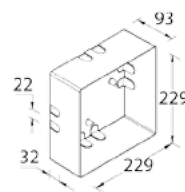
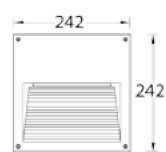

Caja de empotrar

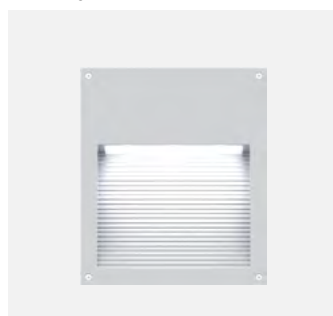
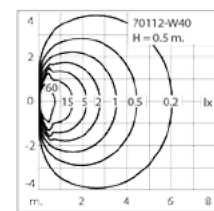

INDIA 4

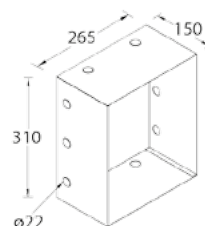
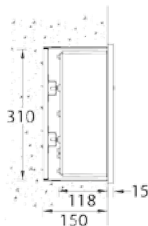
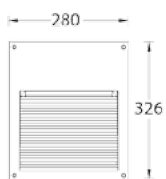

Caja de empotrar

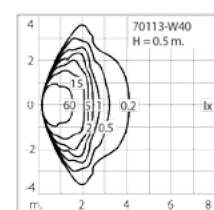

INDIA Luminarias empotrables



INDIA 5

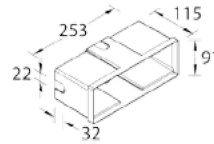
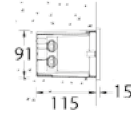
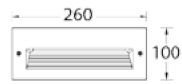

Caja de empotrar

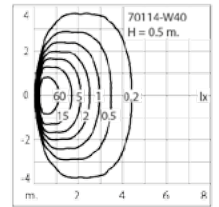

INDIA 6

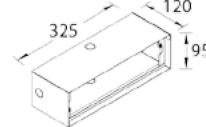
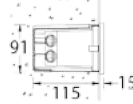

Caja de empotrar

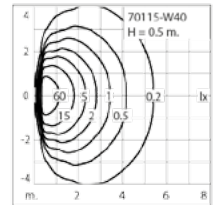

INDIA 7

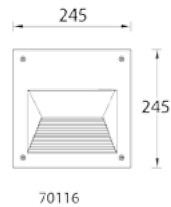

70116

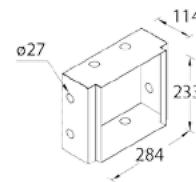
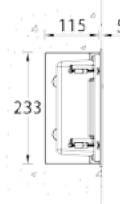

Caja de empotrar

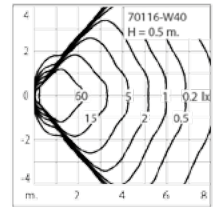

Pinza de anclaje

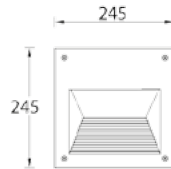

70117

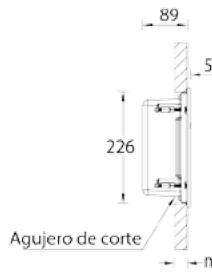

Agujero de corte

INDIA 7 (70117)
Medida agujero de corte 226x226mm.

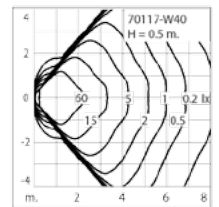

INDIA 7



70116-W30

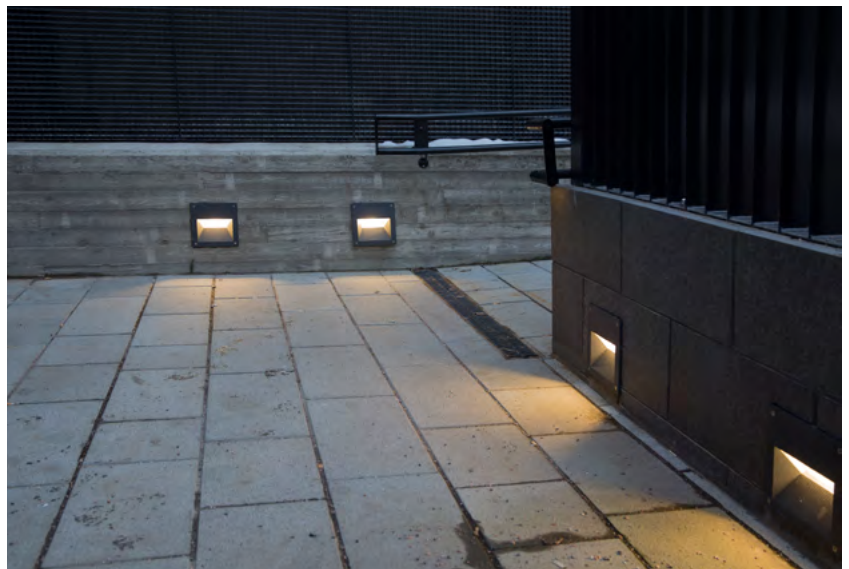

MICA

Luminarias empotrable

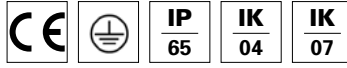

Potentes luces compactas empotradas en la pared y marcadores. Versiones blindadas o no blindadas con cajas de retroceso y tres colores claros.

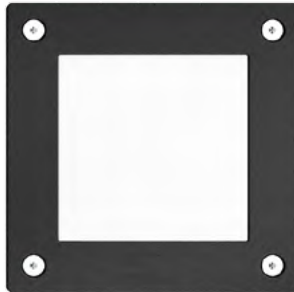

Código de color de luminaria

-01 Negro	-02 Gris Oscuro	-03 Blanco	-05 Plata Mate	-06 Bronce
RAL 9011	RAL 7043	RAL 9003	RAL 9006	RAL 6014



Estructura de Luminaria

- Carcasa y marco de aluminio fundido a presión pretratados antes del recubrimiento en polvo que garantizan una alta resistencia a la corrosión
- Dos entradas de cable para cableado pasante
- Sujetadores de acero inoxidable en grado 316
- Junta de goma de silicona duradera
- Difusor de vidrio templado

Símbolos de funciones



Símbolos de luz



G

MICA Luminarias empotrables

Guía código producto

70120 - W30 - ND - 02

CCT Color Luminaria Tipo Dimm

Temperatura del color
W30 - 3000K
W40 - 4000K

Tipo Regulación
ND - No dimmable

Color Luminaria
01 - Negro
02 - Gris Oscuro
03 - Blanco
05 - Plata Mate
06 - Bronce

Código	Chip	Potencia	Lumen	EEC	Peso	Óptica	CCT	Electrónica	
						G			
Con caja de empotrar - Redondo - Marco no blindado - IK04									
MICA 2R	70120	1 COB	5 W	209 - 225 lm	A++	0.5 kg	86°	W 30 40	ND
Con caja de empotrar - Redondo - Marco blindado - IK07									
MICA 3R	70121	1 COB	5 W	46 - 50 lm	A++	0.5 kg	89°x59°	W 30 40	ND
Con caja de empotrar - Cuadrado - Marco no blindado - IK04									
MICA 2S	70122	1 COB	5 W	209 - 225 lm	A++	0.6 kg	92°	W 30 40	ND
Con caja de empotrar - Cuadrado - Marco blindado - IK07									
MICA 3S	70123	1 COB	5 W	40 - 43 lm	A++	0.5 kg	75°x55°	W 30 40	ND

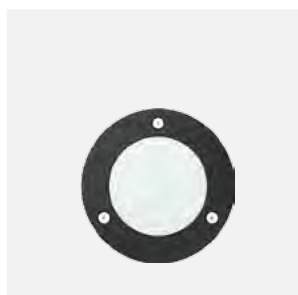

MICA 2R

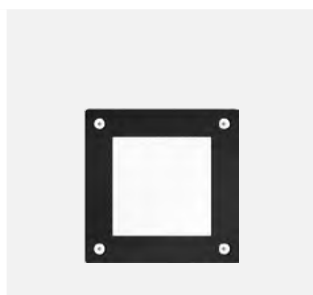

MICA 2S

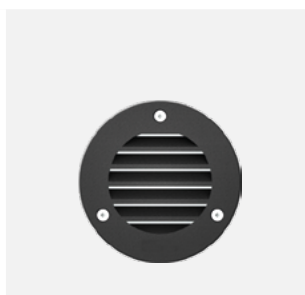

MICA 3R

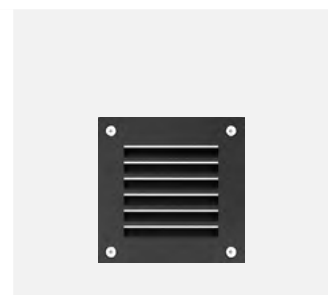

MICA 3S

MICA 2

MICA 3

Redondo

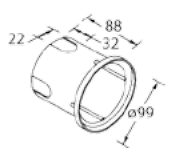
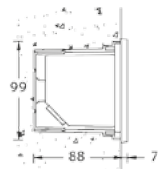
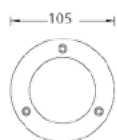

Caja de empotrar

Redondo

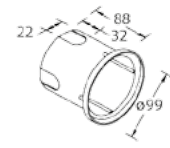
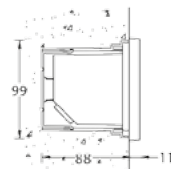
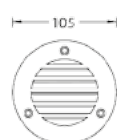

Caja de empotrar

Cuadrado

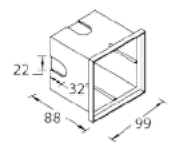
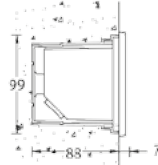
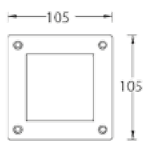

Caja de empotrar

Cuadrado

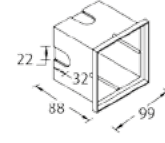
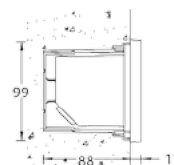
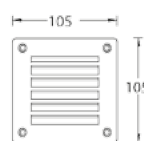

Caja de empotrar

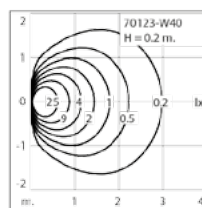
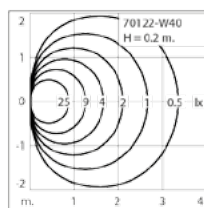
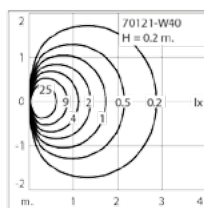
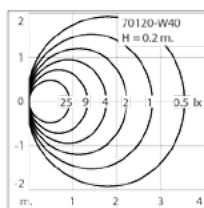



LUMINARIAS DE SUPERFICIE



MAGNUS
página 49



MORGAN
página 53



DAISY
página 57

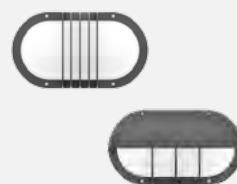

AMERY
página 61



VELA
página 64



GIA
página 68



MARLON
página 72



PAYTON
página 75



PIPER
página 79



KORA
página 82



GARRET
página 84



NEAL
página 88



HESTER
página 91



HUNTER
página 94

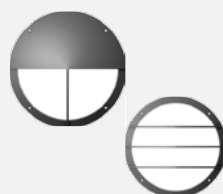

NALA
página 97



VALDUS
página 100



Luminarias de pared integrales delgadas para montaje de superficie. Hermosos y contemporáneos accesorios de pared de superficie adecuados para cualquier ubicación.

MAGNUS

Luminarias de superficie

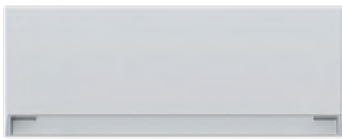

Código de color de luminaria

-01	-02	-03	-05	-06
Negro	Gris Oscuro	Blanco	Plata Mate	Bronce
RAL 9011	RAL 7043	RAL 9003	RAL 9006	RAL 6014



Estructura de Luminaria

- Estructura y cuerpo de aluminio fundido a presión pretratados antes del recubrimiento en polvo, lo que garantiza una alta resistencia a la corrosión
- Entrada de cable única
- Sujetadores de acero inoxidable en grado 316
- Junta de goma de silicona duradera
- Difusor de vidrio esmerilado
- Equipo de control integral

Símbolos de funciones



Símbolos de luz



G

MAGNUS Luminarias de superficie

Guía código producto

70130 - W30 - ND - 01

CCT Color Luminaria Tipo Dimm

Temperatura del color
W30 - 3000K
W40 - 4000K

Tipo Regulación
ND - No dimmable

Color Luminaria
01 - Negro
02 - Gris Oscuro
03 - Blanco
05 - Plata Mate
06 - Bronce

	Código	Chip	Potencia	Lumen	EEC	Peso	Óptica	CCT	Electrónica
Mediano							G		
MAGNUS 1	70130	30 LED	11 W	765 - 783 lm	A+	1.3 kg	101°x70°	W 30 40	ND
Grande									
MAGNUS 2	70131	30 LED	11 W	765 - 783 lm	A+	1.7 kg	101°x70°	W 30 40	ND
MAGNUS 3	70132	30 LED	11 W	765 - 783 lm	A+	1.7 kg	101°x70°	W 30 40	ND
Pequeño									
MAGNUS 6	70133	12 LED	7 W	310 - 323 lm	A+	0.9 kg	91°x54°	W 30 40	ND
MAGNUS 7	70134	12 LED	7 W	315 - 329 lm	A+	0.9 kg	92°x55°	W 30 40	ND

	Caja montaje para MAGNUS 1	Caja montaje para MAGNUS 2	Caja montaje para MAGNUS 3	Caja montaje para MAGNUS 6	Caja montaje para MAGNUS 7
	70135	70136	70137	70138	70139
70130	•				
70131		•			
70132			•		
70133				•	
70134					•



MAGNUS 1

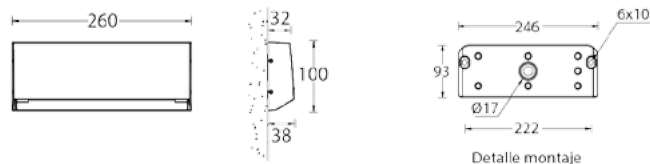

MAGNUS 2

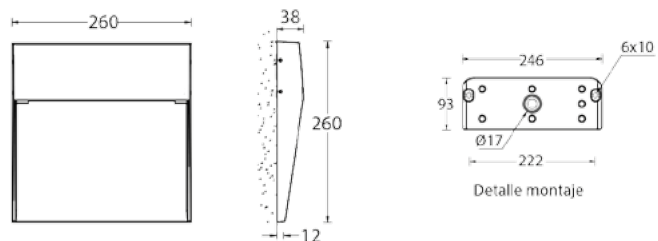

MAGNUS Luminarias de superficie



MAGNUS 3

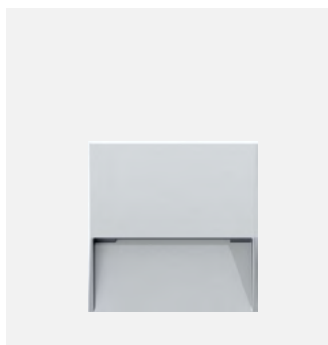
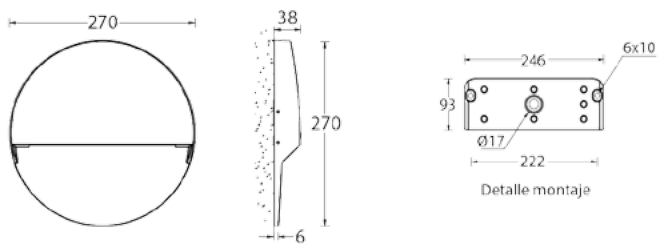

MAGNUS 6

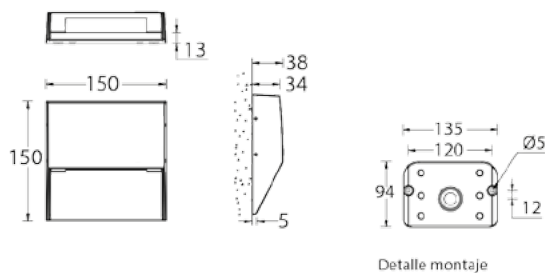

MAGNUS 7

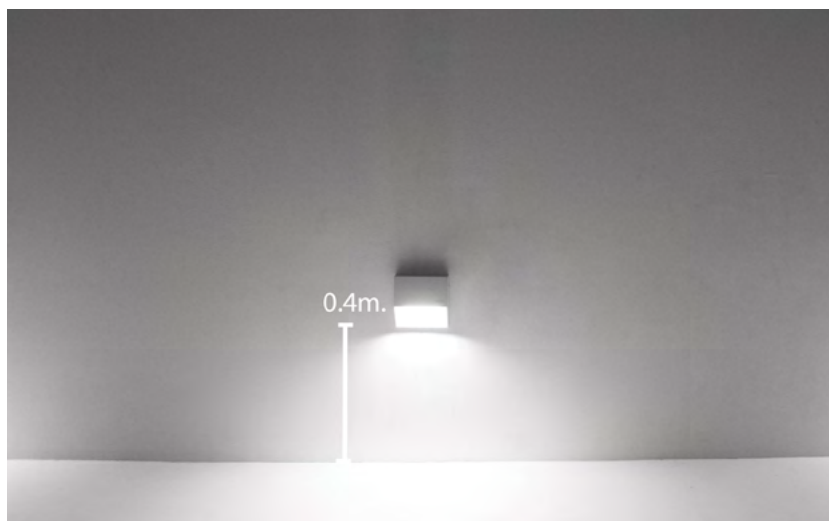
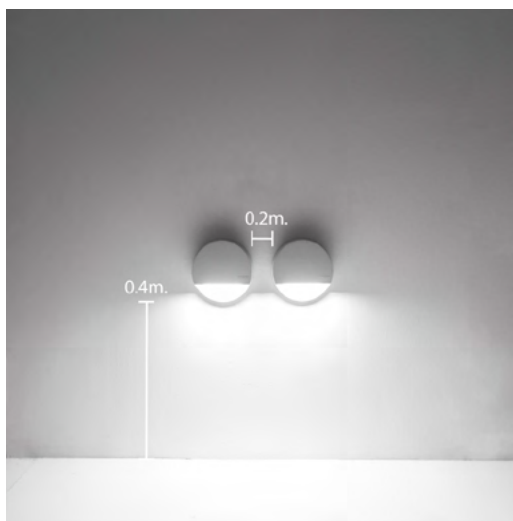
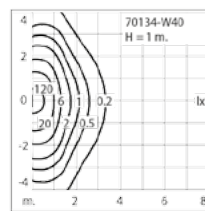
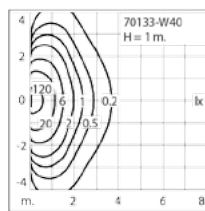
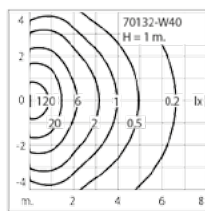
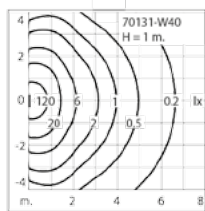
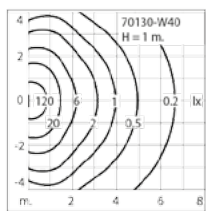
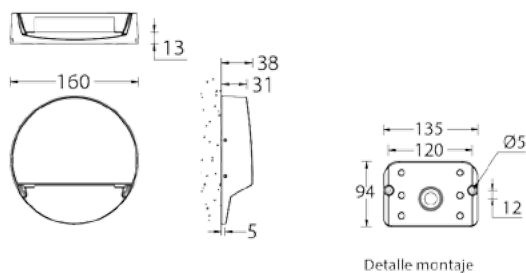

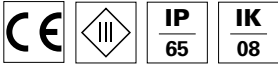

MORGAN

Luminarias de superficie

Elegante y delgada luminaria lineal LED de alto brillo y bajo perfil para bañador de pared y aplicación de pantalla de video LED.



Código de color de luminaria

- 01	- 02	- 03	- 05	- 06
Negro	Gris Oscuro	Blanco	Plata Mate	Bronce
RAL 9011	RAL 7043	RAL 9003	RAL 9006	RAL 6014



Estructura de Luminaria

- Carcasa de aleación de aluminio con recubrimiento en polvo
- Soporte de acero inoxidable ajustable
- Dos entradas de cable para cableado pasante
- Distribución brillante y uniforme, con un tratamiento perfecto con montaje continuo
- Voltaje constante (CV) 24V
- El controlador remoto no está incluido
- Entrada DC24V, dirección DMX512 con control de corriente constante para productos RGBW

Símbolos de funciones



Símbolos de luz

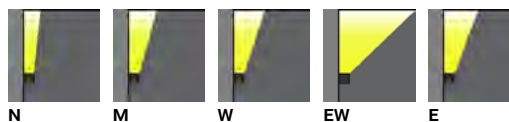

MORGAN Luminarias de superficie

Guía código producto

70150 - EW - W30 - ND - 01



Temperatura del Color
 W30 - 3000K
 W40 - 4000K
 40 - RGBW 4000K

Tipo Regulación
 ND - No dimmable
 DI - Dimmable 1-10V
 DA - Dimmable DALI

Color Luminaria
 01 - Negro
 02 - Gris Oscuro
 03 - Blanco
 05 - Plata Mate
 06 - Bronce

Código	Chip	Potencia	Lumen	EEC	Peso	Óptica					CCT	Electrónica	
						N	M	W	EW	E			
Sin driver control remoto - Voltaje Constante (CV) 24V - 28x40.7 mm - 500 mm													
MORGAN 1	70150	24 LED	6 W	356 - 381 lm	A+	0.32 kg	-	-	-	90°	-	W 30 40	ND DI DA
Sin driver control remoto - Voltaje Constante (CV) 24V - 28x40.7 mm - 1000 mm													
MORGAN 1	70151	48 LED	12 W	712 - 762 lm	A+	0.64 kg	-	-	-	90°	-	W 30 40	ND DI DA
Sin driver control remoto - Voltaje Constante (CV) 24V - 28x43.5 mm - 500 mm - RGBW													
MORGAN 1	70152	24 LED	6 W	128 lm	A	0.36 kg	-	-	-	80°	-	RGBW40	DMX
Sin driver control remoto - Voltaje Constante (CV) 24V - 28x43.5 mm - 1000 mm - RGBW													
MORGAN 1	70153	48 LED	12 W	255 lm	A	0.72 kg	-	-	-	80°	-	RGBW40	DMX
Sin driver control remoto - Voltaje Constante (CV) 24V - 37x60.6 mm - 1000 mm													
MORGAN 2	70154	18 LED	18 W	1436 - 1556 lm	A+	1.56 kg	12°	30°	45°	-	15°x50°	W 30 40	ND DI DA
	70155	24 LED	24 W	1963 - 2127 lm	A+	1.6 kg	12°	30°	45°	-	15°x50°	W 30 40	ND DI DA
	70156	24 LED	36 W	2459 - 2664 lm	A+	1.6 kg	12°	30°	45°	-	15°x50°	W 30 40	ND DI DA
Sin driver control remoto - Voltaje Constante (CV) 24V - 37x60.6 mm - 1000 mm - RGBW													
MORGAN 2	70157	18 LED	18 W	684 - 689 lm	A	1.68 kg	-	30°	45°	-	25°x40°	RGBW40	DMX
	70158	18 LED	24 W	1024 - 1037 lm	A	1.7 kg	-	30°	45°	-	25°x40°	RGBW40	DMX
	70159	18 LED	36 W	970 - 983 lm	A	1.7 kg	-	30°	45°	-	25°x40°	RGBW40	DMX
Sin driver control remoto - Voltaje Constante (CV) 24V - 37x60.6 mm - 500 mm													
MORGAN 2	70160	9 LED	9 W	718 - 778 lm	A+	0.78 kg	12°	30°	45°	-	15°x50°	W 30 40	ND DI DA
	70161	12 LED	12 W	982 - 1064 lm	A+	0.8 kg	12°	30°	45°	-	15°x50°	W 30 40	ND DI DA
	70162	12 LED	18 W	1229 - 1332 lm	A+	0.8 kg	12°	30°	45°	-	15°x50°	W 30 40	ND DI DA
Sin driver control remoto - Voltaje Constante (CV) 24V - 37x60.6 mm - 500 mm - RGBW													
MORGAN 2	70163	9 LED	9 W	342 - 345 lm	A	0.84 kg	-	30°	45°	-	25°x40°	RGBW40	DMX
	70164	9 LED	12 W	512 - 519 lm	A	0.85 kg	-	30°	45°	-	25°x40°	RGBW40	DMX
	70165	9 LED	18 W	488 - 492 lm	A	0.85 kg	-	30°	45°	-	25°x40°	RGBW40	DMX
Sin driver control remoto - Voltaje Constante (CV) 24V - 47x72 mm - 1000 mm													
MORGAN 3	70166	24 LED	48 W	2966 - 3213 lm	A+	1.85 kg	12°	30°	45°	-	15°x50°	W 30 40	ND DI DA
Sin driver control remoto - Voltaje Constante (CV) 24V - 47x72 mm - 1000 mm - RGBW													
MORGAN 3	70167	24 LED	36 W	1027 - 1035 lm	A	2 kg	-	30°	45°	-	25°x40°	RGBW40	DMX
Sin driver control remoto - Voltaje Constante (CV) 24V - 47x72 mm - 500 mm													
MORGAN 3	70168	12 LED	24 W	1483 - 1607 lm	A+	0.93 kg	12°	30°	45°	-	15°x50°	W 30 40	ND DI DA
Sin driver control remoto - Voltaje Constante (CV) 24V - 47x72 mm - 500 mm - RGBW													
MORGAN 3	70169	12 LED	18 W	514 - 518 lm	A	1 kg	-	30°	45°	-	25°x40°	RGBW40	DMX
Sin driver control remoto - Voltaje Constante (CV) 24V - 77x95 mm - 1000 mm													
MORGAN 4	70170	36 LED	72 W	4634 - 5020 lm	A+	2.85 kg	12°	30°	45°	-	15°x50°	W 30 40	ND DI DA
Sin driver control remoto - Voltaje Constante (CV) 24V - 77x95 mm - 1000 mm - RGBW													
MORGAN 4	70171	36 LED	72 W	2784 - 2805 lm	A	2.9 kg	-	30°	45°	-	25°x40°	RGBW40	DMX
Sin driver control remoto - Voltaje Constante (CV) 24V - 77x95 mm - 500 mm													
MORGAN 4	70172	18 LED	36 W	2317 - 2510 lm	A+	1.43 kg	12°	30°	45°	-	15°x50°	W 30 40	ND DI DA
Sin driver control remoto - Voltaje Constante (CV) 24V - 77x95 mm - 500 mm - RGBW													
MORGAN 4	70173	18 LED	36 W	1393 - 1403 lm	A	1.45 kg	-	30°	45°	-	25°x40°	RGBW40	DMX

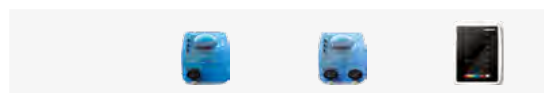

Dispositivo control DMX Dispositivo control DMX Mando DMX

79100 **79101** **79102**

70150			
70151			
70152	•	•	•
70153	•	•	•
70154			
70155			
70156			
70157	•	•	•
70158	•	•	•
70159	•	•	•
70160			
70161			



Dispositivo control DMX Dispositivo control DMX Mando DMX

79100 **79101** **79102**

70162			
70163	•	•	•
70164	•	•	•
70165	•	•	•
70166			
70167	•	•	•
70168			
70169	•	•	•
70170			
70171	•	•	•
70172			
70173	•	•	•

MORGAN Luminarias de superficie



MORGAN 1



MORGAN 1



MORGAN 2



MORGAN 2

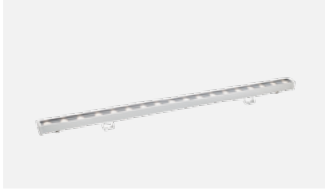

MORGAN 3



MORGAN 3



MORGAN 4

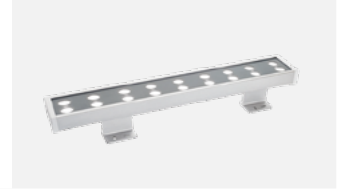

MORGAN 4

MORGAN 1

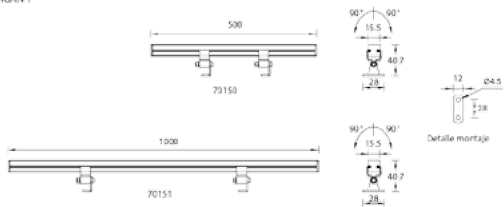

MORGAN 1 RGEW

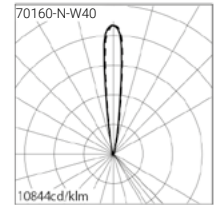
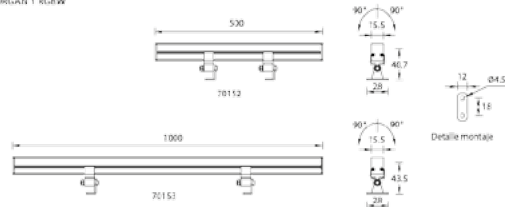

MORGAN 2

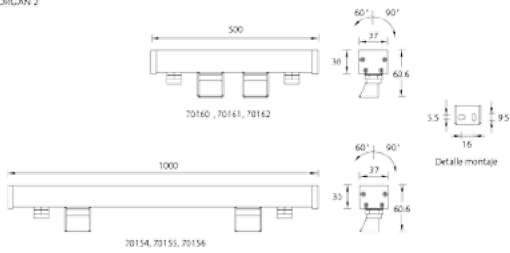

MORGAN 2 RGEW

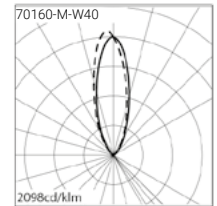
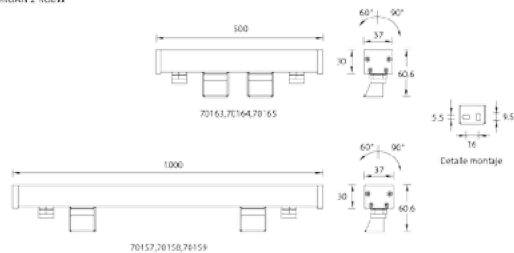

MORGAN 3

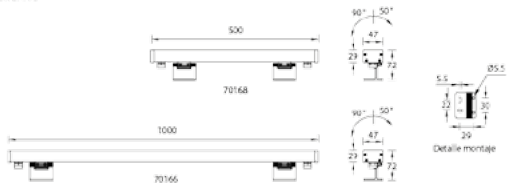

MORGAN 3 RGEW

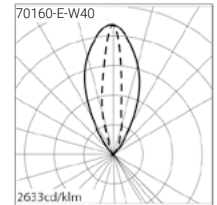
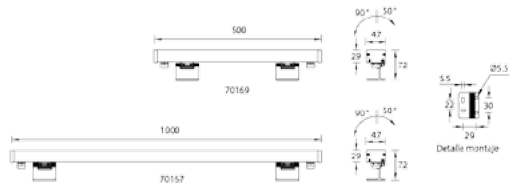

MORGAN 4

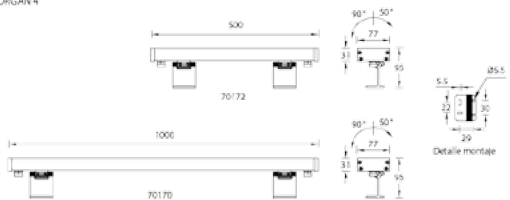

MORGAN 4 RGEW

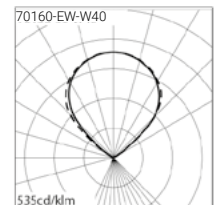
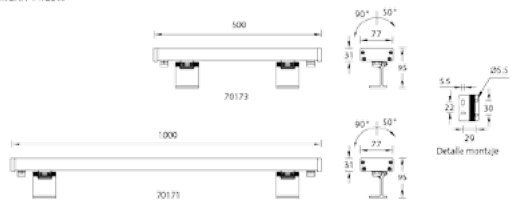

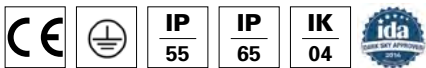

Familia de luminarias de pared de vecindario urbano clásico. Líneas atemporales combinadas con una calidad de construcción, flexibilidad y rendimiento incomparables.

DAISY

Luminarias de superficie



Código de color de luminaria

-01	-02	-03	-05	-06
Negro	Gris Oscuro	Blanco	Plata Mate	Bronce
RAL 9011	RAL 7043	RAL 9003	RAL 9006	RAL 6014



Estructura de Luminaria

- Estructura y cuerpo de aluminio fundido a presión pretratados antes del recubrimiento en polvo asegurando una alta resistencia a la corrosión
- Dos entradas de cable para cableado pasante
- Sujetadores de acero inoxidable en grado 316
- Junta de goma de silicona duradera
- Difusor de cristal opal
- Equipo de control integral

Símbolos de funciones



Símbolos de luz

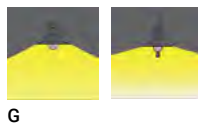

DAISY Luminarias de superficie

Guía código producto 70660 - 2 - 1 - W30 - DI - 01 Difusor Cúpula CCT Tipo Dimm Color Luminaria	Tipo difusor 1 - Curvo 2 - Cónico	Temperatura del color W30 - 3000K W40 - 4000K	Tipo Regulación ND - No dimmable DI - Dimmable 1-10V DA - Dimmable DALI	Color Luminaria 01 - Negro 02 - Gris Oscuro 03 - Blanco 05 - Plata Mate 06 - Bronce
Estilo de cúpula 1 - Redonda 2 - Cónica				

Código	Chip	Potencia	Lumen	EEC	Peso	Óptica	CCT	Electrónica
Pequeño - Difusor curvo - Cúpula redonda								
DAISY 7	70660-1-1	1 COB	29 W	1082 - 1105 lm	A++	6.3 kg	143°	W 30 40
Pequeño - Difusor curvo - Cúpula cónica								
DAISY 7	70660-1-2	1 COB	29 W	1082 - 1105 lm	A++	6.3 kg	143°	W 30 40
Pequeño - Difusor cónico - Cúpula redonda								
DAISY 7	70660-2-1	1 COB	29 W	1082 - 1105 lm	A++	6.3 kg	143°	W 30 40
Pequeño - Difusor cónico - Cúpula cónica								
DAISY 7	70660-2-2	1 COB	29 W	1082 - 1105 lm	A++	6.3 kg	143°	W 30 40
Mediano - Difusor curvo - Cúpula redonda								
DAISY 8	70661-1-1	1 COB	41 W	2449 - 2479 lm	A++	8.9 kg	133°	W 30 40
Mediano - Difusor curvo - Cúpula cónica								
DAISY 8	70661-1-2	1 COB	41 W	2449 - 2479 lm	A++	8.9 kg	133°	W 30 40
Mediano - Difusor cónico - Cúpula redonda								
DAISY 8	70661-2-1	1 COB	41 W	2601 - 2632 lm	A++	8.9 kg	133°	W 30 40
Mediano - Difusor cónico - Cúpula cónica								
DAISY 8	70661-2-2	1 COB	41 W	2601 - 2632 lm	A++	8.9 kg	133°	W 30 40

Caja de Montaje (DAISY 7)
70665

70660-1-1	•
70660-1-2	•
70660-2-1	•
70660-2-2	•

Caja de Montaje(DAISY 8)
70666

70661-1-1	•
70661-1-2	•
70661-2-1	•
70661-2-2	•



DAISY 7

DAISY 7 Pequeño

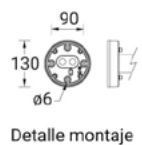
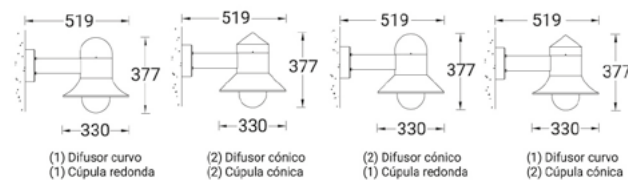

DAISY 8

Daisy 8 Mediano

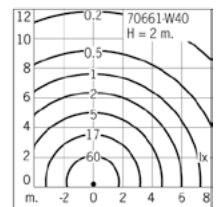
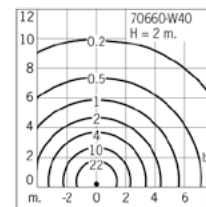
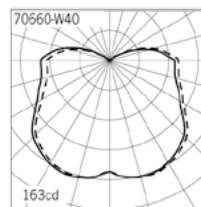
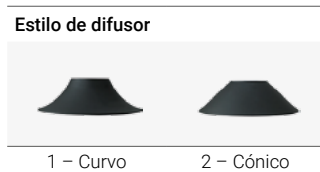
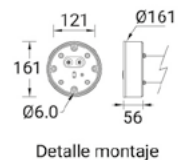
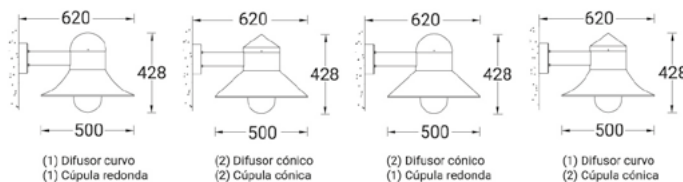

DAISY Luminarias de superficie

Guía código producto

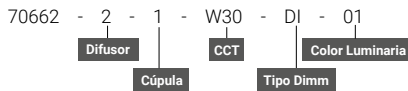

Tipo difusor

- 1 - Curvo
 - 2 - Cónico
- Estilo de cúpula
- 1 - Redonda
 - 2 - Cónica

Temperatura del color

- W30 - 3000K
- W40 - 4000K

Tipo Regulación

- ND - No dimmable
- DI - Dimmable 1-10V
- DA - Dimmable DALI

Color Luminaria

- 01 - Negro
- 02 - Gris Oscuro
- 03 - Blanco
- 05 - Plata Mate
- 06 - Bronce

Código	Chip	Potencia	Lumen	EEC	Peso	Óptica								CCT	Electrónica	
						M	W	VW	EW	T2	T3	T4	G			
Brazo curvo - Mediano - Difusor curvo - Cúpula redonda																
DAISY 9	70662-1-1	1 COB	41 W	2449 - 2479 lm	A++	8.6 kg	-	-	-	-	-	-	-	133°	W 30 40	ND DI DA
Brazo curvo - Mediano - Difusor curvo - Cúpula cónica																
DAISY 9	70662-1-2	1 COB	41 W	2449 - 2479 lm	A++	8.6 kg	-	-	-	-	-	-	-	133°	W 30 40	ND DI DA
Brazo curvo - Mediano - Difusor cónico - Cúpula redonda																
DAISY 9	70662-2-1	1 COB	41 W	2601 - 2632 lm	A++	8.6 kg	-	-	-	-	-	-	-	133°	W 30 40	ND DI DA
Brazo curvo - Mediano - Difusor cónico - Cúpula cónica																
DAISY 9	70662-2-2	1 COB	41 W	2601 - 2632 lm	A++	8.6 kg	-	-	-	-	-	-	-	133°	W 30 40	ND DI DA
Brazo curvo - Grande - Difusor curvo - Cúpula redonda - IP65																
DAISY 10	70663-1-1	2x12 LED	40 W	3429 - 4222 lm	A++	13.5 kg	30°	52°	66°	122°	141°x51°	141°x67°	98°x69°	-	W 30 40	ND DI DA
Brazo curvo - Grande - Difusor curvo - Cúpula cónica - IP65																
DAISY 10	70663-1-2	2x12 LED	40 W	3429 - 4222 lm	A++	13.5 kg	30°	52°	66°	122°	141°x51°	141°x67°	98°x69°	-	W 30 40	ND DI DA
Brazo curvo - Grande - Difusor cónico - Cúpula redonda - IP65																
DAISY 10	70663-2-1	2x12 LED	40 W	3429 - 4222 lm	A++	13.5 kg	30°	52°	66°	122°	141°x51°	141°x67°	98°x69°	-	W 30 40	ND DI DA
Brazo curvo - Grande - Difusor cónico - Cúpula cónica - IP65																
DAISY 10	70663-2-2	2x12 LED	40 W	3429 - 4222 lm	A++	13.5 kg	30°	52°	66°	122°	141°x51°	141°x67°	98°x69°	-	W 30 40	ND DI DA



DAISY 9

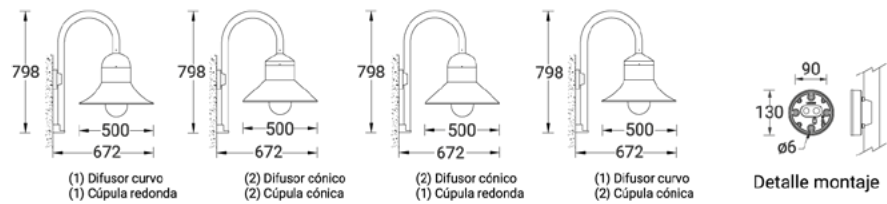

DAISY 10

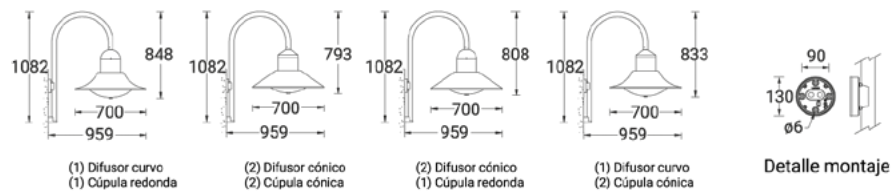

Estilo de difusor



1 - Curvo 2 - Cónico

Estilo de cúpula



1 - Redonda 2 - Cónica

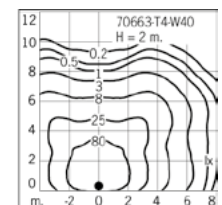
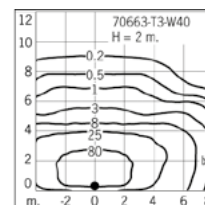
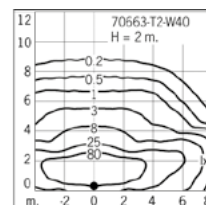
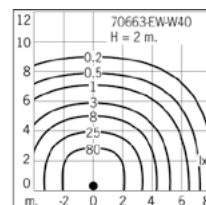
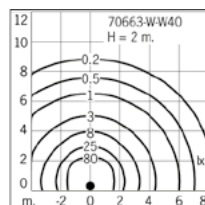
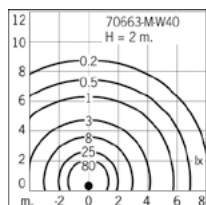



Gama de mamparo blindado de pared. Mamparos utilitarios clásicos con numerosas opciones y un toque contemporáneo.

AMIVERY

Luminarias de superficie

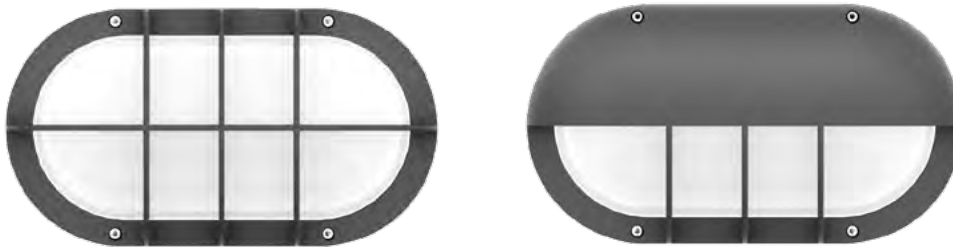

Código de color de luminaria

- 01 Negro	- 02 Gris Oscuro	- 03 Blanco	- 05 Plata Mate	- 06 Bronce
RAL 9011	RAL 7043	RAL 9003	RAL 9006	RAL 6014



Símbolos de funciones

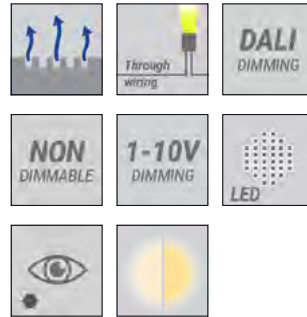

Símbolos de luz



Estructura de Luminaria

- Carcasa y marco de aluminio fundido a presión pretratados antes del recubrimiento en polvo, lo que garantiza una alta resistencia a la corrosión
- Dos entradas de cable para cableado pasante
- Sujetadores de acero inoxidable en grado 316
- Junta de goma de silicona duradera
- Difusor de policarbonato opalino, resistente a los golpes, estabilizado a los rayos UV
- Equipo de control integral

AMERY Luminarias de superficie

Guía código producto 70180 - W30 - ND - 01 CCT Tipo Dimm Color Luminaria	Temperatura del Color W30 - 3000K W40 - 4000K	Tipo Regulación ND - No dimmable DI - Dimmable 1-10V DA - Dimmable DALI	Color Luminaria 01 - Negro 02 - Gris Oscuro 03 - Blanco 05 - Plata Mate 06 - Bronce
--	---	--	--

	Código	Chip	Potencia	Lumen	EEC	Peso	Óptica	CCT	Electrónica
							G		
AMERY 1	70180	48 LED	15 W	497 - 552 lm	A+	2.2 kg	88°x151°	W 30 40	ND DI DA
AMERY 3	70181	48 LED	15 W	663 - 737 lm	A+	2.2 kg	128°x151°	W 30 40	ND DI DA
AMERY 4	70182	48 LED	15 W	509 - 566 lm	A+	2.2 kg	100°x151°	W 30 40	ND DI DA
AMERY 5	70183	48 LED	15 W	273 - 303 lm	A+	2.2 kg	96°x13°	W 30 40	ND DI DA



AMERY 1

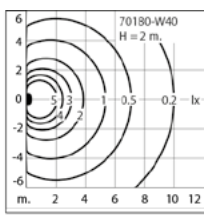
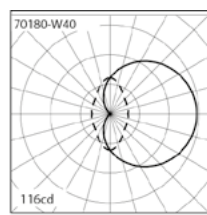
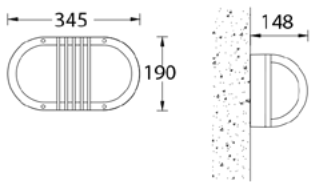

AMERY 3

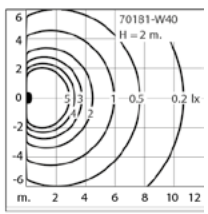
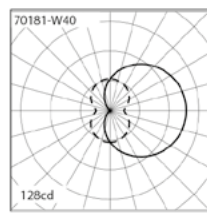
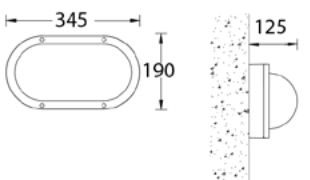

AMERY 4

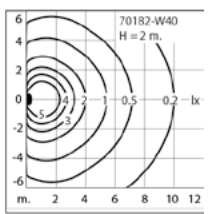
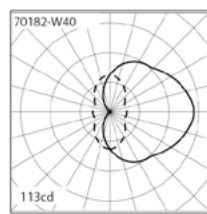
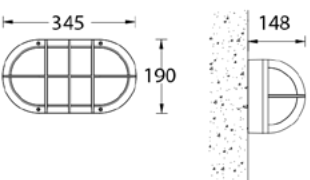

AMERY 5

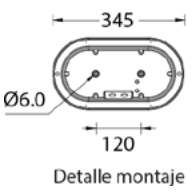
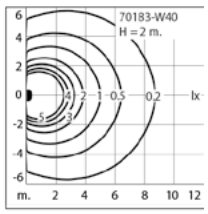
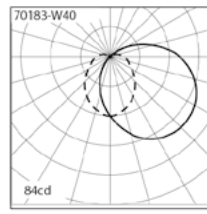
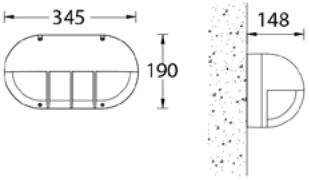

VELMA

Luminarias de superficie

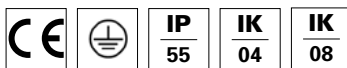

Gama de paredes de superficie exterior clásica y rentable. Forma urbana elegante con acento de luz lateral y tonos opcionales.



Código de color de luminaria

-01 Negro	-02 Gris Oscuro	-03 Blanco	-05 Plata Mate	-06 Bronce
RAL 9011	RAL 7043	RAL 9003	RAL 9006	RAL 6014



Estructura de Luminaria

- Carcasa de aluminio fundido a presión pretratada antes del recubrimiento en polvo que garantiza una alta resistencia a la corrosión
- Dos entradas de cable para cableado pasante
- Sujetadores de acero inoxidable en grado 316
- Junta de goma de silicona duradera
- Difusor de cristal opal
- Equipo de control integral

Símbolos de funciones



Símbolos de luz



G

VELMA Luminarias de superficie

<p>Guía código producto</p> <p>70472 - 2 - 1 - W30 - DI - 01</p> <p>Difusor Cúpula CCT Color Luminaria Tipo Dimm</p>	<p>Tipo difusor</p> <p>1 - Curvo</p> <p>2 - Cónico</p> <p>Estilo de cúpula</p> <p>1 - Redonda</p> <p>2 - Cónica</p>	<p>Temperatura del color</p> <p>W30 - 3000K</p> <p>W40 - 4000K</p>	<p>Tipo Regulación</p> <p>ND - No dimmable</p> <p>DI - Dimmable 1-10V</p> <p>DA - Dimmable DALI</p>	<p>Color Luminaria</p> <p>01 - Negro</p> <p>02 - Gris Oscuro</p> <p>03 - Blanco</p> <p>05 - Plata Mate</p> <p>06 - Bronce</p>
--	---	--	---	---

Código	Chip	Potencia	Lumen	EEC	Peso	Óptica	CCT	Electrónica
							G	
Difusor curvo - Cúpula redonda - IK08								
VELMA 6	70472-1-1	1 COB	41 W	2019 - 2044 lm	A++	9.0 kg	149°	W 30 40 ND DI DA
Difusor curvo - Cúpula cónica - IK08								
VELMA 6	70472-1-2	1 COB	41 W	2019 - 2044 lm	A++	9.0 kg	149°	W 30 40 ND DI DA
Difusor cónico - Cúpula redonda - IK08								
VELMA 6	70472-2-1	1 COB	41 W	2156 - 2182 lm	A++	9.0 kg	149°	W 30 40 ND DI DA
Difusor cónico - Cúpula cónica - IK08								
VELMA 6	70472-2-2	1 COB	41 W	2156 - 2182 lm	A++	9.0 kg	149°	W 30 40 ND DI DA



Caja de Montaje (VELMA 6)
70477

70472-1-1	•
70472-1-2	•
70472-2-1	•
70472-2-2	•

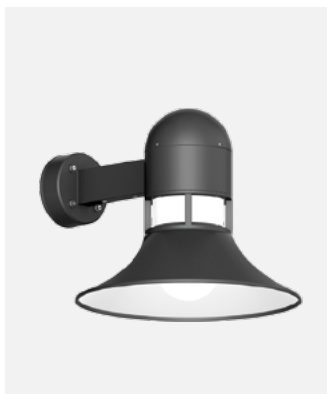

VELMA 6

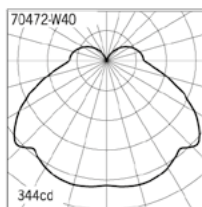
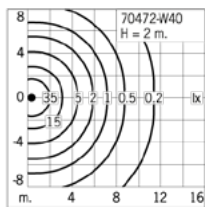
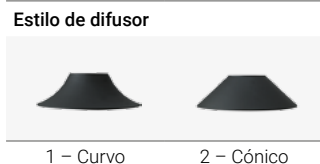
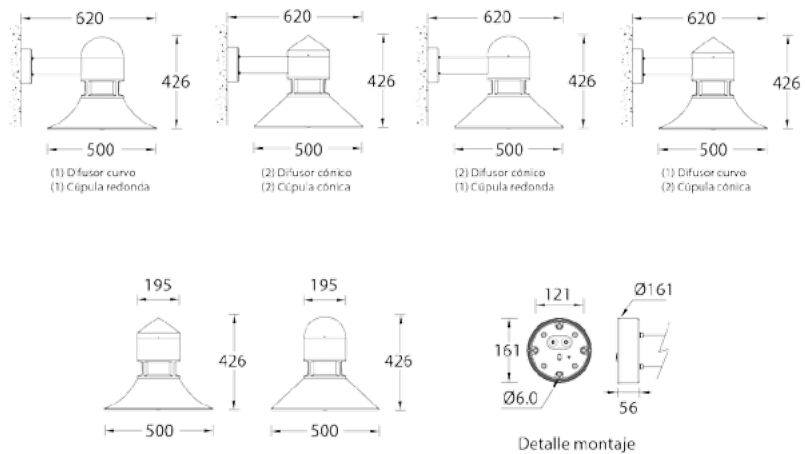

VELMA Luminarias de superficie

<p>Guía código producto</p> <p>70473 - 2 - 1 - W30 - DI - 01</p> <p>Difusor: 2 Cúpula: 1 CCT: W30 Tipo Dimm: DI Color Luminaria: 01</p>	<p>Tipo difusor</p> <p>1 - Curvo 2 - Cónico</p> <p>Estilo de cúpula</p> <p>1 - Redonda 2 - Cónica</p>	<p>Temperatura del color</p> <p>W30 - 3000K W40 - 4000K</p>	<p>Tipo Regulación</p> <p>ND - No dimmable DI - Dimmable 1-10V DA - Dimmable DALI</p>	<p>Color Luminaria</p> <p>01 - Negro 02 - Gris Oscuro 03 - Blanco 05 - Plata Mate 06 - Bronce</p>
---	---	---	---	---

Código	Chip	Potencia	Lumen	EEC	Peso	Óptica	CCT	Electrónica
Brazo curvo - Difusor curvo - Cúpula redonda - IK04								
VELMA 7	70473-1-1	1 COB	41 W	2019 - 2044 lm	A++	9.2 Kg	144°	W 30 40 ND DI DA
Brazo curvo - Difusor curvo - Cúpula cónica - IK04								
VELMA 7	70473-1-2	1 COB	41 W	2019 - 2044 lm	A++	9.2 Kg	144°	W 30 40 ND DI DA
Brazo curvo - Difusor cónico - Cúpula redonda - IK04								
VELMA 7	70473-2-1	1 COB	41 W	2156 - 2182 lm	A++	9.2 Kg	144°	W 30 40 ND DI DA
Brazo curvo - Difusor cónico - Cúpula cónica - IK04								
VELMA 7	70473-2-2	1 COB	41 W	2156 - 2182 lm	A++	9.2 Kg	144°	W 30 40 ND DI DA



VELMA 7

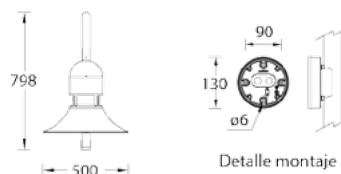
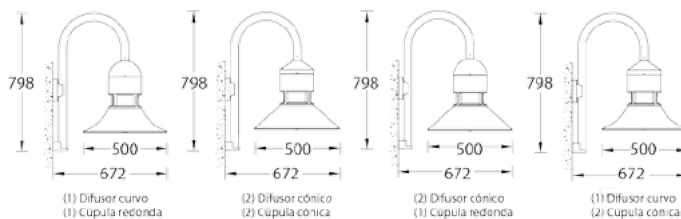

Estilo de difusor



1 - Curvo

2 - Cónico

Estilo de cúpula



1 - Redonda

2 - Cónica

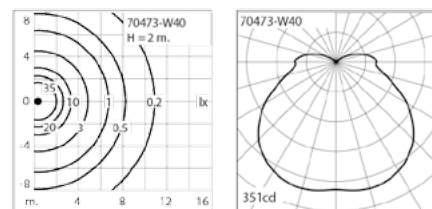

GIA

Luminarias de superficie



Accesorios compactos de superficie apantallados empotrados en la pared. Dos tamaños de escala residencial, que proporcionan una iluminación suave ascendente y descendente.



Código de color de luminaria

-01 Negro	-02 Gris Oscuro	-03 Blanco	-05 Plata Mate	-06 Bronce
RAL 9011	RAL 7043	RAL 9003	RAL 9006	RAL 6014



Estructura de Luminaria

- Carcasa de aluminio fundido a presión pretratada antes del recubrimiento en polvo que garantiza una alta resistencia a la corrosión
- Dos entradas de cable para cableado pasante
- Sujetadores de acero inoxidable en grado 316
- Junta de goma de silicona duradera
- Difusor de cristal opal
- Equipo de control integral

Símbolos de funciones



Símbolos de luz



G

GIA Luminarias de superficie

<p>Guía código producto</p> <p>70491 - 1 - 1 - 1 - W30 - DI - 01</p> <p>Difusor Cúpula CCT Tipo Dimm Color Luminaria</p>	<p>Tipo difusor</p> <p>1 - Curvo 2 - Cónico</p> <p>Estilo de cúpula</p> <p>1 - Redonda 2 - Cónica</p>	<p>Temperatura del color</p> <p>W30 - 3000K W40 - 4000K</p>	<p>Tipo Regulación</p> <p>ND - No dimmable DI - Dimmable 1-10V DA - Dimmable DALI</p>	<p>Color Luminaria</p> <p>01 - Negro 02 - Gris Oscuro 03 - Blanco 05 - Plata Mate 06 - Bronce</p>
--	---	---	---	---

Código	Chip	Potencia	Lumen	EEC	Peso	Óptica	CCT	Electrónica	
						G			
Pequeño - Difusor curvo - Cúpula redonda									
GIA 6	70491-1-1	1 COB	20 W	1359 - 1376 lm	A++	3.7 kg	139°	W 30 40 ND DI DA	
Pequeño - Difusor curvo - Cúpula cónica									
GIA 6	70491-2-1	1 COB	20 W	1359 - 1376 lm	A++	3.7 kg	139°	W 30 40 ND DI DA	
Mediano - Difusor curvo - Cúpula redonda									
GIA 7	70492-1-1	1 COB	41 W	1635 - 1654 lm	A++	9.2 kg	128°	W 30 40 ND DI DA	
Mediano - Difusor curvo - Cúpula cónica									
GIA 7	70492-1-2	1 COB	41 W	1635 - 1654 lm	A++	9.2 kg	128°	W 30 40 ND DI DA	
Mediano - Difusor cónico - Cúpula redonda									
GIA 7	70492-2-1	1 COB	41 W	1763 - 1785 lm	A++	9.2 kg	128°	W 30 40 ND DI DA	
Mediano - Difusor cónico - Cúpula cónica									
GIA 7	70492-2-2	1 COB	41 W	1763 - 1785 lm	A++	9.2 kg	128°	W 30 40 ND DI DA	



Caja de montaje (GIA 6)
70496

70491-1-1	•
70491-2-1	•

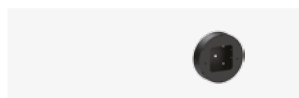

Caja de montaje (GIA 7)
70497

70492-1-1	•
70492-2-1	•

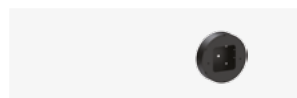

Caja de montaje (GIA 7)
70498

70492-2-1	•
70492-2-2	•

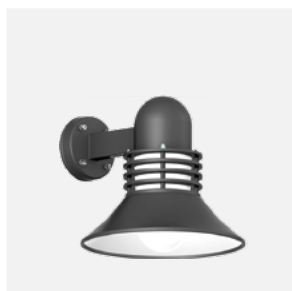

GIA 6



GIA 7

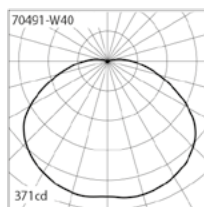
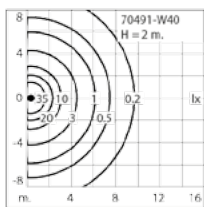
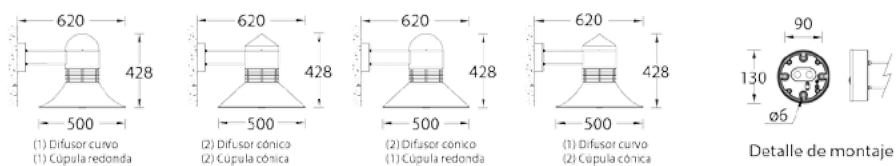

GIA Luminarias de superficie

<p>Guía código producto</p> <p>70493 - 1 - 1 - W30 - DI - 01</p> <p>Difusor Cúpula CCT Tipo Dimm Color Luminaria</p>	<p>Tipo difusor</p> <p>1 - Curvo</p> <p>2 - Cónico</p> <p>Estilo de cúpula</p> <p>1 - Redonda</p> <p>2 - Cónica</p>	<p>Temperatura del color</p> <p>W30 - 3000K</p> <p>W40 - 4000K</p>	<p>Tipo Regulación</p> <p>ND - No dimmable</p> <p>DI - Dimmable 1-10V</p> <p>DA - Dimmable DALI</p>	<p>Color Luminaria</p> <p>01 - Negro</p> <p>02 - Gris Oscuro</p> <p>03 - Blanco</p> <p>05 - Plata Mate</p> <p>06 - Bronce</p>
--	---	--	---	---

Código	Chip	Potencia	Lumen	EEC	Peso	Óptica	CCT	Electrónica	
							G		
Brazo curvo - Mediano - Difusor curvo - Cúpula redonda									
GIA 8	70493-1-1	1 COB	41 W	1635 - 1710 lm	A++	9.6 kg	128°	W 30 40	ND DI DA
Brazo curvo - Mediano - Difusor curvo - Cúpula cónica									
GIA 8	70493-1-2	1 COB	41 W	1635 - 1654 lm	A++	9.6 kg	128°	W 30 40	ND DI DA
Brazo curvo - Mediano - Difusor cónico - Cúpula redonda									
GIA 8	70493-2-1	1 COB	41 W	1763 - 1785 lm	A++	9.6 kg	128°	W 30 40	ND DI DA
Brazo curvo - Mediano - Difusor cónico - Cúpula cónica									
GIA 8	70493-2-2	1 COB	41 W	1763 - 1785 lm	A++	9.6 kg	128°	W 30 40	ND DI DA



GIA 8

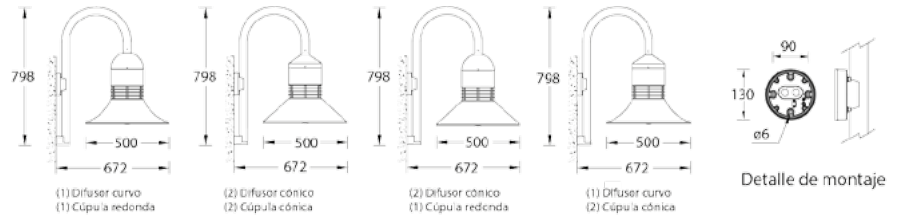

Estilo de difusor



1 - Curvo

2 - Cónico

Estilo de cúpula



1 - Redonda

2 - Cónica

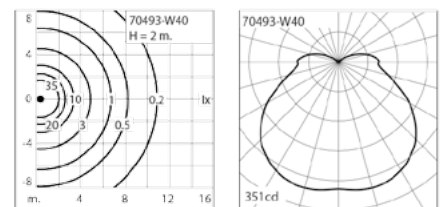

MARLON

Luminarias de superficie



Familia de luminarias de superficie de alto confort visual empotradas en la pared. Familia de iluminación urbana robusta pero decorativa con distribución de luz lateral control perfecto de destello.

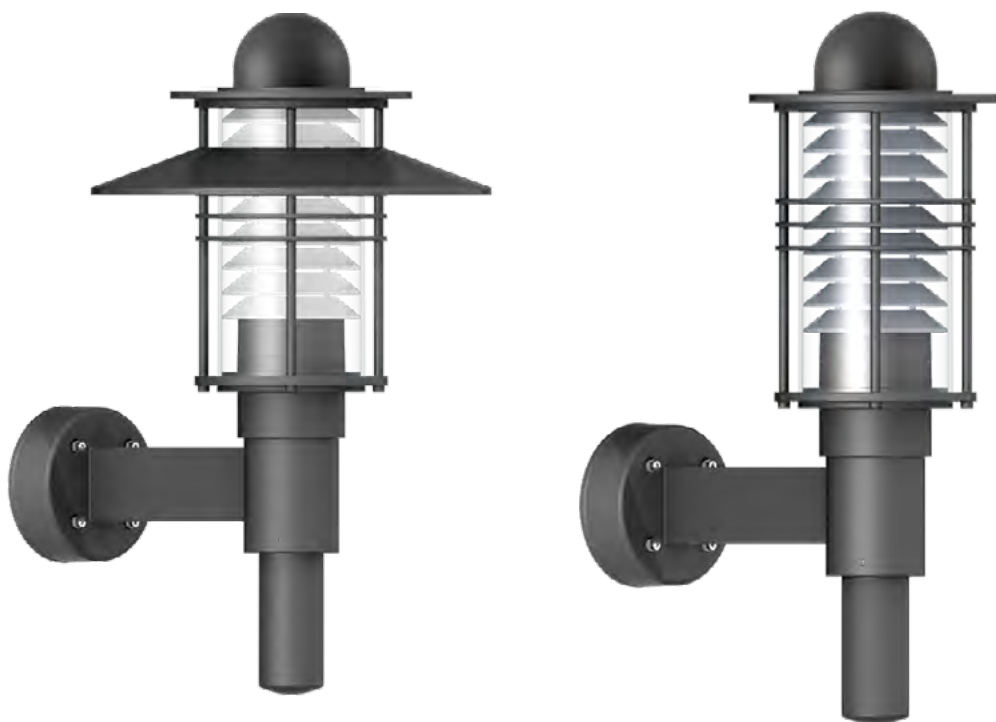

Código de color de luminaria

-01 Negro	-02 Gris Oscuro	-03 Blanco	-05 Plata Mate	-06 Bronce
RAL 9011	RAL 7043	RAL 9003	RAL 9006	RAL 6014



Estructura de Luminaria

- Carcasa de aluminio fundido a presión pretratada antes del recubrimiento en polvo que garantiza una alta resistencia a la corrosión
- Dos entradas de cable para cableado pasante
- Sujetadores de acero inoxidable en grado 316
- Junta de goma de silicona duradera
- Reflector de aluminio con acabado arenado
- Difusor de policarbonato transparente, resistente a los impactos y estabilizado a los rayos UV
- Equipo de control integral

Símbolos de funciones



Símbolos de LUZ



MARLON Luminarias de superficie

<p>Guía código producto</p> <p>70190 - 1 - W30 - ND - 01</p> <p> Óptica CCT Tipo Dimm Color Luminaria </p>	<p>Estilo de cúpula</p> <p>1 - Redondeada 2 - Plana 3 - Punteada</p>	<p>Temperatura del Color</p> <p>W30 - 3000K W40 - 4000K</p> <p>Tipo Regulación</p> <p>ND - No dimmable</p>	<p>Color Luminaria</p> <p>01 - Negro 02 - Gris Oscuro 03 - Blanco 05 - Plata Mate 06 - Bronce</p>
--	---	--	--

Código	Chip	Potencia	Lumen	EEC	Peso	Óptica	CCT	Electrónica	
						G			
Cúpula superior redondeada con sombra									
MARLON 1	70190-1	1 COB	41 W	979 - 991 lm	A++	13.0 kg	176°	W 30 40	ND
Cúpula superior redondeada sin sombra									
MARLON 2	70191-1	1 COB	41 W	1040 - 1053 lm	A++	11.8 kg	176°	W 30 40	ND
Cúpula superior plana con sombra									
MARLON 1	70190-2	1 COB	41 W	979 - 991 lm	A++	13.0 kg	176°	W 30 40	ND
Cúpula superior plana sin sombra									
MARLON 2	70191-2	1 COB	41 W	1040 - 1053 lm	A++	11.8 kg	176°	W 30 40	ND
Cúpula superior punteada con sombra									
MARLON 1	70190-3	1 COB	41 W	979 - 991 lm	A++	13.0 kg	176°	W 30 40	ND
Cúpula superior punteada sin sombra									
MARLON 2	70191-3	1 COB	41 W	1040 - 1053 lm	A++	11.8 kg	176°	W 30 40	ND



MARLON 1

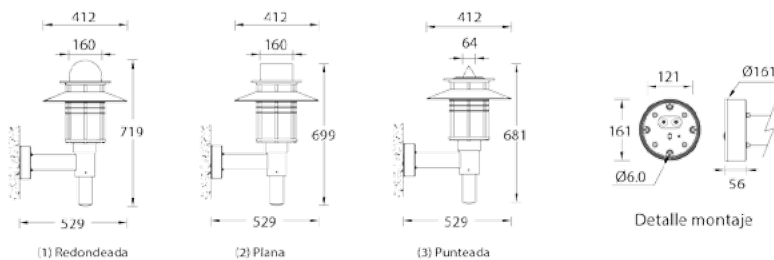

MARLON 2

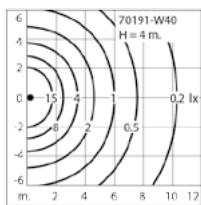
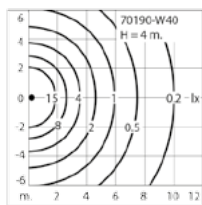
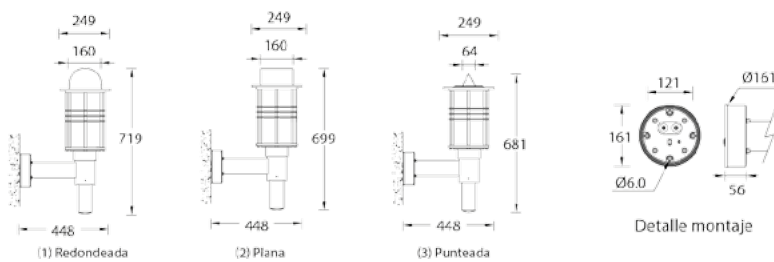

Estilo de cúpula





Su alta eficiencia cumple con el factor de forma clásica. Gama completa de soluciones de iluminación decorativa de gran impacto con múltiples distribuciones de haces de luz y eficiencia superior.

PAYTON

Luminarias de superficie



Código de color de luminaria

- 01 Negro	- 02 Gris Oscuro	- 03 Blanco	- 05 Plata Mate	- 06 Bronce
RAL 9011	RAL 7043	RAL 9003	RAL 9006	RAL 6014



Estructura de Luminaria

- Carcasa y marco de aluminio fundido a presión pretratados antes del recubrimiento en polvo, lo que garantiza una alta resistencia a la corrosión
- Entrada de cable única
- Sujetadores de acero inoxidable en grado 316
- Junta de goma de silicona duradera
- Difusor de policarbonato opalino, resistente a los golpes y estabilizado a los rayos UV
- Los modelos con pantalla tendrán un revestimiento de color blanco en el interior de la luminaria de sombra y un revestimiento de la superficie exterior según el color de la luminaria.
- Equipo de control integral

Símbolos de funciones



Símbolos de luz

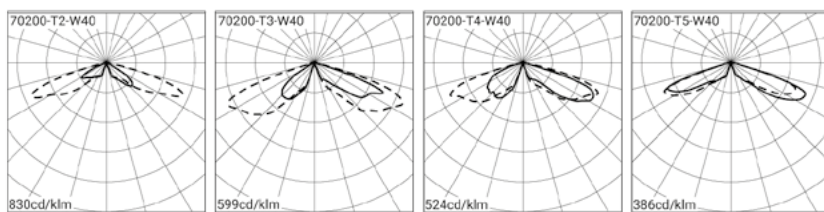
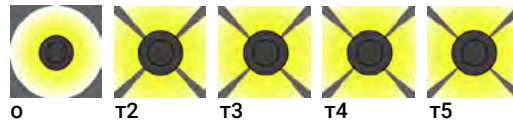

PAYTON Luminarias de superficie

Guía código producto

70200 - T2 - W30 - ND - 01

Óptica CCT Tipo Dimm Color Luminaria

Óptica
 O - Difusor opal

Temperatura del color
 W30 - 3000K
 W40 - 4000K

Tipo Regulación
 ND - No dimmable
 DI - Dimmable 1-10V
 DA - Dimmable DALI

Color Luminaria
 01 - Negro
 02 - Gris Oscuro
 03 - Blanco
 05 - Plata Mate
 06 - Bronce

Código	Chip	Potencia	Lumen	EEC	Peso	Óptica					CCT	Electrónica	
						O	T2	T3	T4	T5			
Ø660 - 683 mm - Parte superior plana con sombra													
PAYTON 1	70200	1 COB	47.5 W	4247 - 4813 lm	A++	9.6 kg	-	143°x86°	132°x99°	131°x117°	119°x134°	W 30 40	ND DI DA
	70201	4 x 40 LED	50.2 W	3903 - 4197 lm	A++	10.8 kg	360°	-	-	-	-	W 30 40	ND DI DA
Ø660 - 683 mm - Parte superior plana con sombra con rejilla													
PAYTON 2	70202	1 COB	47.5 W	3413 - 3749 lm	A++	10.3 kg	-	143°x84°	141°x89°	129°x115°	143°	W 30 40	ND DI DA
	70203	4 x 40 LED	50.2 W	3046 - 3275 lm	A++	11.5 kg	360°	-	-	-	-	W 30 40	ND DI DA
Ø1081 - 707 mm - Parte superior plana con sombra													
PAYTON 3	70204	1 COB	69.6 W	6476 - 7522 lm	A++	15.8 kg	-	145°x87°	141°x91°	134°x118°	145°	W 30 40	ND DI DA
	70205	3 x 60 LED	60 W	4234 - 4553 lm	A++	16.8 kg	360°	-	-	-	-	W 30 40	ND DI DA
Ø1081 - 707 mm - Parte superior plana con sombra con rejilla													
PAYTON 4	70206	1 COB	69.6 W	5976 - 6603 lm	A++	16.6 kg	-	145°x84°	126°x106°	133°x116°	163°	W 30 40	ND DI DA
	70207	3 x 60 LED	60 W	3469 - 4053 lm	A++	17.6 kg	360°	-	-	-	-	W 30 40	ND DI DA
Ø660 - 683 mm - Parte superior plana sin sombra													
PAYTON 5	70208	1 COB	47.5 W	4221 - 4780 lm	A++	7.4 kg	-	142°x87°	131°x100°	128°x118°	161°	W 30 40	ND DI DA
	70209	4 x 40 LED	50.2 W	42387 - 4556 lm	A++	8.6 kg	360°	-	-	-	-	W 30 40	ND DI DA
Ø660 - 683 mm - Parte superior plana sin sombra con rejilla													
PAYTON 6	70210	1 COB	47.5 W	3191 - 3711 lm	A++	8.1 kg	-	140°x100°	132°x103°	137°x117°	73°	W 30 40	ND DI DA
	70211	4 x 40 LED	50.2 W	3279 - 3526 lm	A++	9.3 kg	360°	-	-	-	-	W 30 40	ND DI DA
Ø492 - 825 mm - Parte superior plana sin sombra													
PAYTON 7	70212	1 COB	69.6 W	7196 - 8415 lm	A++	11.3 kg	-	145°x87°	141°x91°	134°x118°	145°	W 30 40	ND DI DA
	70213	3 x 60 LED	60 W	4234 - 4553 lm	A++	12.3 kg	360°	-	-	-	-	W 30 40	ND DI DA
Ø492 - 825 mm - Parte superior plana sin sombra con rejilla													
PAYTON 8	70214	1 COB	69.6 W	5976 - 6603 lm	A++	12.3 kg	-	145°x84°	126°x106°	133°x116°	163°	W 30 40	ND DI DA
	70215	3 x 60 LED	60 W	3469 - 4053 lm	A++	13.0 kg	360°	-	-	-	-	W 30 40	ND DI DA
Ø250 - 466 mm - Parte superior plana sin sombra													
PAYTON 9	70216	4 x 40 LED	50 W	4366 - 4813 lm	A++		-	143°x86°	132°x99°	131°x117°	118°x134°	W 30 40	ND DI DA
Ø250 - 466 mm - Parte superior plana con sombra con rejilla													
PAYTON 10	70217	4 x 40 LED	50 W	3413 - 3749 lm	A++		-	143°x84°	141°x89°	129°x115°	143°	W 30 40	ND DI DA
Ø250 - 466 mm - Parte superior plana con sombra													
PAYTON 11	70218	1 COB	48 W	3903 - 4197 lm	A++		360°	-	-	-	-	W 30 40	ND DI DA
Ø250 - 466 mm - Parte superior plana con sombra con rejilla													
PAYTON 12	70219	1 COB	48 W	3046 - 3275 lm	A++		360°	-	-	-	-	W 30 40	ND DI DA



PAYTON 1 - PAYTON 2

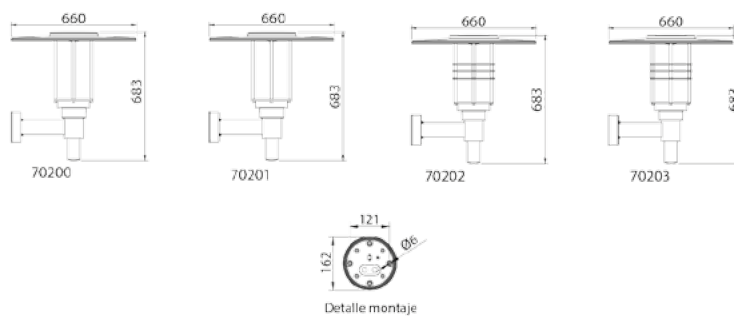

PAYTON 5 - PAYTON 6

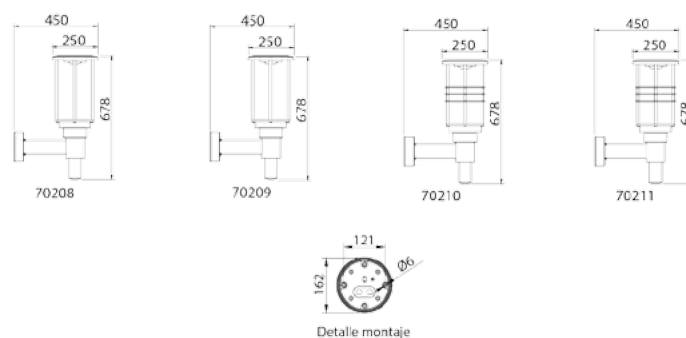

PAYTON Luminarias de superficie



PAYTON 3 - PAYTON 4

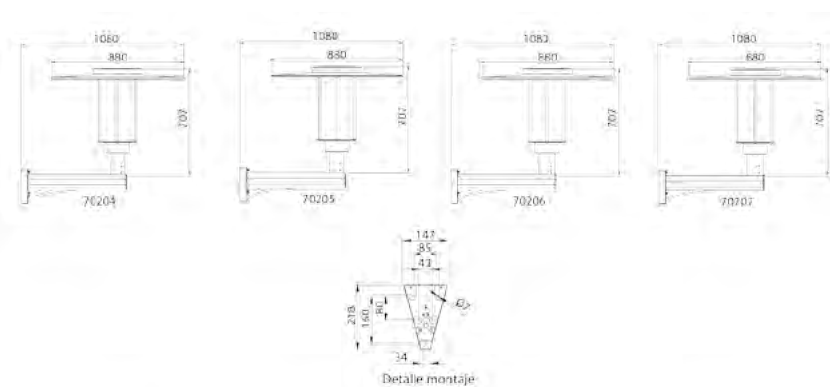

PAYTON 7 - PAYTON 8

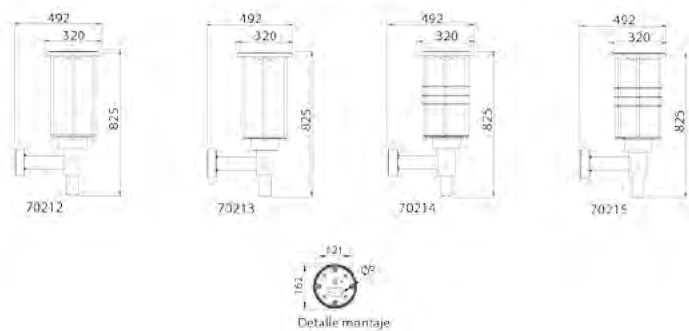

PAYTON 9



PAYTON 10



PAYTON 11



PAYTON 12

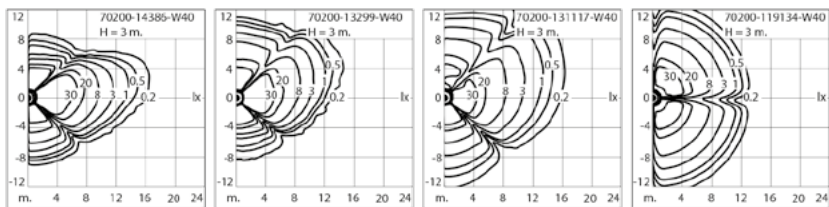

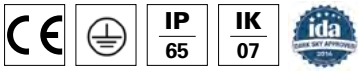

Gama de luminarias de ambiente y fachada de obra. Familia elegante, compacta y amplia de luminarias con paquetes de iluminación y ópticas para satisfacer cualquier necesidad.

PIPER

Luminarias de superficie



Código de color de luminaria

-01	-02	-03	-05	-06
Negro	Gris Oscuro	Blanco	Plata Mate	Bronce
RAL 9011	RAL 7043	RAL 9003	RAL 9006	RAL 6014



Estructura de luminaria

- Carcasa y marco de aluminio fundido a presión pretratados antes del recubrimiento en polvo, lo que garantiza una alta resistencia a la corrosión
- Entrada de cable única
- Sujetadores de acero inoxidable en grado 316
- Junta de goma de silicona duradera
- Difusor de vidrio templado transparente, resistente a los impactos
- Equipo de control integral

Símbolos de funciones

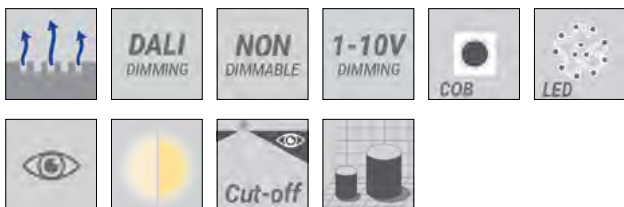

Símbolos de luz

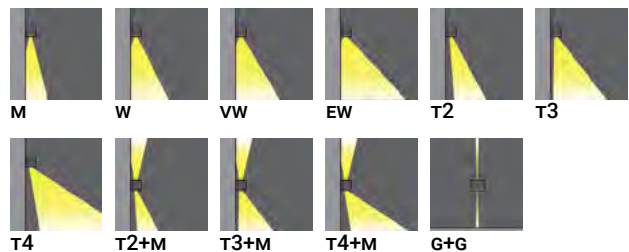

PIPER Luminarias de superficie

Guía código producto

70234 - M - W - W30 - DI - 01

Óptica
Down | Up

CCT

Tipo Dimm
Color Luminaria

Temperatura del Color
 W30 - 3000K
 W40 - 4000K

Tipo Regulación
 ND - No dimmable
 DI - Dimmable 1-10V
 DA - Dimmable DALI

Color Luminaria
 01 - Negro
 02 - Gris Oscuro
 03 - Blanco
 05 - Plata Mate
 06 - Bronce

Código	Chip	Potencia	Lumen	EEC	Peso	Óptica								CCT	Electrónica	
						M	W	VW	EW	T2	T3	T4	G			
Difusor opal - Down																
PIPER 2	70235	1 COB	4.5 W	236 lm	A++	1.0 kg	-	-	-	-	-	-	-	91°	W 30 40	ND
PIPER 4	70241	2 x 1 COB	8 W	298 lm	A++	1.6 kg	-	-	-	-	-	-	-	94°	W 30 40	ND DI DA
Difusor transparente - Down																
PIPER 2	70236	1 LED	2 W	51 lm	A++	1.0 kg	-	-	-	-	-	-	-	60°	W 30 40	ND
	70237	1 LED	2 W	3 lm	A++	1.0 kg	-	-	-	-	-	-	-	3°	W 30 40	ND
	70238	4 LED	6 W	283 - 444 lm	A++	0.85 kg	32°	53°	65°	83°x 99°	130°x41°	108°x54°	88°x61°	-	W 30 40	ND
PIPER 4	70242	8 LED	10 W	734 - 982 lm	A++	1.86 kg	30°	51°	65°	98°x 118°	141°x49°	139°x66°	98°x76°	-	W 30 40	ND DI DA
Difusor opal - Down & Up																
PIPER 1	70230	2 x 1 COB	8 W	253 lm	A++	1.0 kg	-	-	-	-	-	-	-	91°&91°	W 30 40	ND
PIPER 3	70239	4 x 1 COB	16 W	562 lm	A++	1.0 kg	-	-	-	-	-	-	-	94°&94°	W 30 40	ND DI DA
Difusor transparente - Down & Up																
PIPER 1	70231	2 x 1 LED	3 W	102 lm	A++	1.0 kg	-	-	-	-	-	-	-	60°&60°	W 30 40	ND
	70232	2 x 1 LED	3 W	54 lm	A++	1.0 kg	-	-	-	-	-	-	-	3°&60°	W 30 40	ND
	70233	2 x 1 LED	3 W	6 lm	A++	1.0 kg	-	-	-	-	-	-	-	3°&3°	W 30 40	ND
	70234	2 x 4 LED	12 W	566 - 888 lm	A++	0.87 kg	32°	53°	65°	83°x 99°	130°x41°	108°x54°	88°x61°	-	W 30 40	ND
PIPER 3	70240	2 x 8 LED	19 W	1468 - 1964 lm	A++	1.97 kg	30°	51°	65°	98°x 118°	141°x49°	139°x66°	98°x76°	-	W 30 40	ND DI DA

Caja de montaje PIPER 1	Caja de montaje PIPER 2	Caja de montaje PIPER 3	Caja de montaje PIPER 4
70250	70251	70252	70253
70230	•		
70231	•		
70232	•		
70233	•		
70235	•		
70236	•		
		70237	
		70239	
		70241	•
		70238	
		70234	•
		70242	•



PIPER 1 Y 2

PIPER 3 Y 4

PIPER 1 Y 2

PIPER 3 Y 4

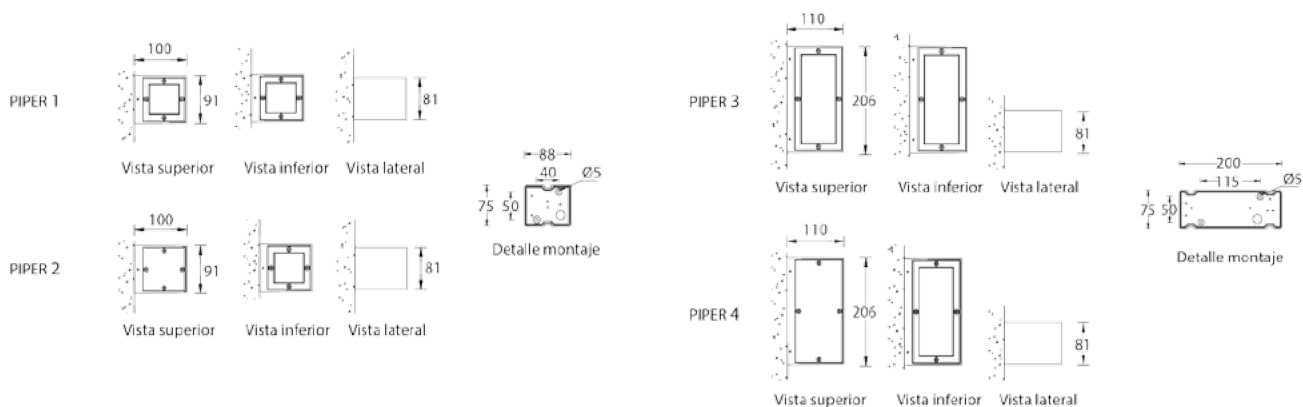

KORA





Luminarias de superficie



Mamparas circulares de contemporáneas de montaje en superficie. Mamparos exteriores resistentes pero atractivos construidos para funcionar y durar.



Código de color de luminaria

				
-01 Negro	-02 Gris Oscuro	-03 Blanco	-05 Plata Mate	-06 Bronce
RAL 9011	RAL 7043	RAL 9003	RAL 9006	RAL 6014

KORA Luminarias de superficie

Símbolos de funciones



Símbolos de luz



G

Estructura de luminaria

- Carcasa y marco de aluminio fundido a presión pretratados antes del recubrimiento en polvo, lo que garantiza una alta resistencia a la corrosión
- Dos entradas de cable para cableado pasante
- Sujetadores de acero inoxidable en grado 316
- Junta de goma de silicona duradera
- Difusor de policarbonato opalino, resistente a los golpes y estabilizado a los rayos UV
- Equipo de control integral





Guía código producto	70260 - W30 - DI - 01	Temperatura del color W30 - 3000K W40 - 4000K	Tipo Regulación ND - No dimmable DI - Dimmable 1-10V DA - Dimmable DALI	Color Luminaria 01 - Negro 02 - Gris Oscuro 03 - Blanco 05 - Plata Mate 06 - Bronce
	<div style="display: flex; justify-content: space-around; align-items: center;"> <div style="border: 1px solid black; padding: 2px;">CCT</div> <div style="border: 1px solid black; padding: 2px;">Color Luminaria</div> </div> <div style="text-align: center; margin-top: 5px;"> <div style="border: 1px solid black; padding: 2px;">Tipo Dimm</div> </div>			

	Código	Chip	Potencia	Lumen	EEC	Peso	Óptica	CCT	Electrónica
Difusor plano							G		
KORA 1	70260	40 LED	20 W	756 lm	A+	2.9 kg	120°x180°	W 30 40	ND DI DA
Difusor redondeado									
KORA 2	70261	40 LED	20 W	726 - 756 lm	A+	2.9 kg	120°x180°	W 30 40	ND DI DA



KORA 1

KORA 2

		
	Caja Montaje KORA 1	Caja Montaje KORA 2
	70263	70264
70260	•	
70261		•

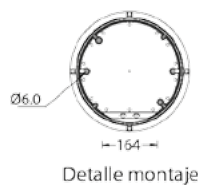
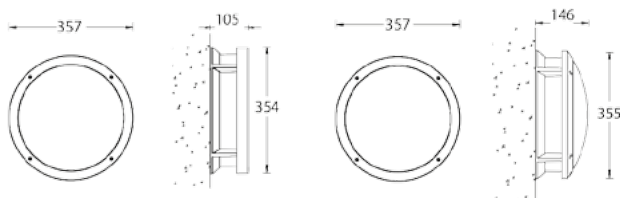

Detalle montaje

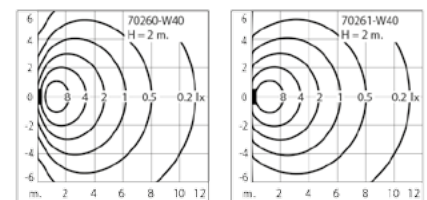



Downlight de pared de forma cilíndrica o rectangular. El alto rendimiento, y las numerosas opciones garantizan que GARRET pueda configurarse para cualquier aplicación.

Luminarias de superficie

GARRET



Código de color de luminaria

-01 Negro	-02 Gris Oscuro	-03 Blanco	-05 Plata Mate	-06 Bronce
RAL 9011	RAL 7043	RAL 9003	RAL 9006	RAL 6014



Estructura de luminaria

- Carcasa de aluminio fundido a presión pretratada antes del recubrimiento en polvo que garantiza una alta resistencia a la corrosión
- Entrada de cable única
- Dos entradas de cable para cableado pasante para 70280, 70281, 70282, 70283
- Sujetadores de acero inoxidable en grado 316
- Junta de goma de silicona duradera
- Reflector Óptica de alta eficiencia
- Vidrio transparente templado
- Equipo de control integral

Símbolos de funciones



Símbolos de luz

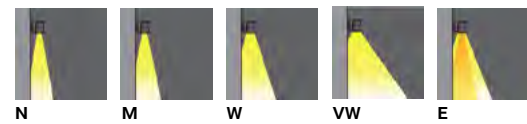

GARRET Luminarias de superficie

Guía código producto

70271 - N - M - W30 - ND - 01

Temperatura del Color
 W30 - 3000K
 W40 - 4000K
 30 - RGBW 3000K
 40 - RGBW 4000K
 65 - RGBW 6500K

Tipo Regulación
 ND - No dimmable
 DI - Dimmable 1-10V
 DA - Dimmable DALI

Color Luminaria
 01 - Negro
 02 - Gris Oscuro
 03 - Blanco
 05 - Plata Mate
 06 - Bronce

Código	Chip	Potencia	Lumen	EEC	Peso	Óptica					CRI & CCT	Electrónica	
						N	M	W	VW	E			
Ø102 - 180 mm - Down & Up - Redondo													
GARRET 1	70270	2 x MR16-GU10	15 W	508 - 790 lm	A	1.1 kg	13°/60°	23°/60°	-	60°/60°	12°x51°/60°	9030 9040	ND
Ø102 - 140 mm - Down - Redondo													
GARRET 4	70271	MR16-GU10	7.5 W	254 - 395 lm	A	0.8 kg	13°	23°	-	60°	12°x51°	9030 9040	ND
Ø102 - 218 mm - Down - Redondo													
GARRET 31	70272	1 COB	15 W	949 - 1107 lm	A++	2.2 kg	20°	24°	36°	71°	-	W 30 40	ND DI DA
102x102 mm - 218 mm - Down - Cuadrado													
GARRET 32	70273	1 COB	15 W	949 - 1107 lm	A++	2.6 kg	20°	24°	36°	71°	-	W 30 40	ND DI DA
Ø160 - 262 mm - Down - Redondo													
GARRET 33	70274	1 COB	39 W	2735 - 3494 lm	A++	3.8 kg	13°	20°	40°	61°	-	W 30 40	ND DI DA
160x160 mm - 263 mm - Down - Cuadrado													
GARRET 34	70275	1 COB	39 W	2735 - 3494 lm	A++	5.1 kg	13°	20°	40°	61°	-	W 30 40	ND DI DA
Ø102 - 218 mm - Down & Up - Redondo													
GARRET 35	70276	2 x 1 COB	28 W	1898 - 2214 lm	A++	2.3 kg	20°	24°	36°	71°	-	W 30 40	ND DI DA
102x102 mm - 218 mm - Down & Up - Cuadrado													
GARRET 36	70277	2 x 1 COB	28 W	1898 - 2214 lm	A++	2.7 kg	20°	24°	36°	71°	-	W 30 40	ND DI DA
Ø160 - 262 mm - Down - Redondo - RGBW													
GARRET 37	70278	2 x 1 COB	78 W	5470 - 6988 lm	A++	5.0 kg	13°	20°	40°	61°	-	W 30 40	ND DI DA
160x160 mm - 263 mm - Down - Cuadrado - RGBW													
GARRET 38	70279	2 x 1 COB	78 W	5470 - 6988 lm	A++	6.2 kg	13°	20°	40°	61°	-	W 30 40	ND DI DA
Ø160 - 262 mm - Down - Redondo - RGBW													
GARRET 51	70280	7 LED	33 W	1119 - 1429 lm	A	4.3 kg	21°	35°	-	-	26° x 48°	RGBW 30 40	DMX
160x160 mm - 263 mm - Down - Cuadrado - RGBW													
GARRET 52	70281	7 LED	33 W	1119 - 1429 lm	A	5.6 kg	21°	35°	-	-	26° x 48°	RGBW 30 40	DMX
Ø160 - 262 mm - Down & Up - Redondo - RGBW													
GARRET 53	70282	2 x 7 LED	66 W	2238 - 2858 lm	A	5.3 kg	21°	35°	-	-	26° x 48°	RGBW 30 40 65	DMX
160x160 mm - 263 mm - Down & Up - Cuadrado - RGBW													
GARRET 54	70283	2 x 7 LED	66 W	2238 - 2858 lm	A	6.7 kg	21°	35°	-	-	26° x 48°	RGBW 30 40 65	DMX



Dispositivo control DMX	Dispositivo control DMX	STICK-KE1	Caja Montaje GARRET 1	Caja Montaje GARRET 31	Caja Montaje GARRET 32	Caja Montaje GARRET 33	Caja Montaje GARRET 34	Caja Montaje GARRET 35	Caja Montaje GARRET 36	Caja Montaje GARRET 37	Caja Montaje GARRET 38
79100	79101	79102	70290	70292	70293	70294	70295	70296	70297	70298	70299

70276											
70272											
70277											
70273											
70278											
70282	.	.	.								
70274											
70280	.	.	.								
70279											
70283	.	.	.								
70275											
70281	.	.	.								
70270											



Caja Montaje GARRET 4	Caja Montaje GARRET 51	Caja Montaje GARRET 52	Caja Montaje GARRET 53	Caja Montaje GARRET 54
70291	70300	70301	70302	70303

70282				
70280	.			
70283				
70281		.		
70271	.			

GARRET Luminaria de superficie



GARRET 31



GARRET 32



GARRET 33



GARRET 34



GARRET 51



GARRET 52

GARRET 1 Redondo

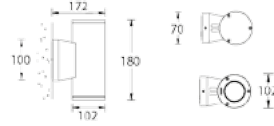

GARRET 4 Redondo

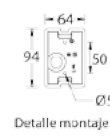
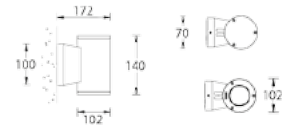

GARRET 31 Redondo

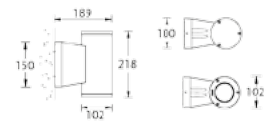

GARRET 32 Cuadrado

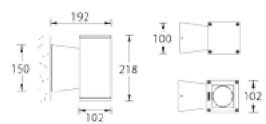

GARRET 35 Redondo

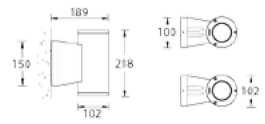

GARRET 36 Cuadrado

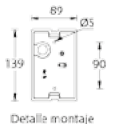
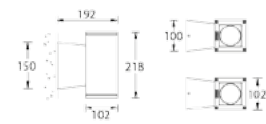

GARRET 33 Redondo

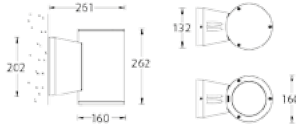

GARRET 34 Cuadrado

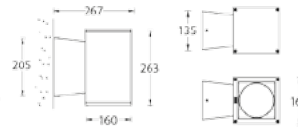

GARRET 37 Redondo

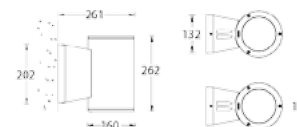

GARRET 38 Cuadrado

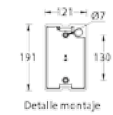
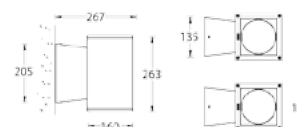

GARRET 51 Redondo

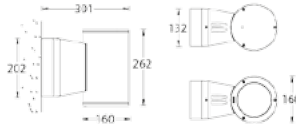

GARRET 52 Cuadrado

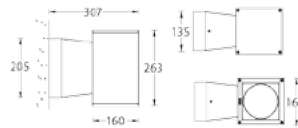

GARRET 53 Redondo

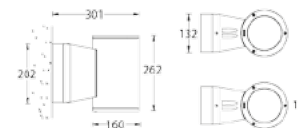

GARRET 54 Cuadrado

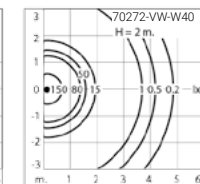
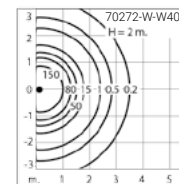
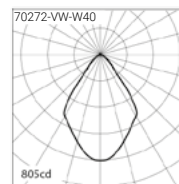
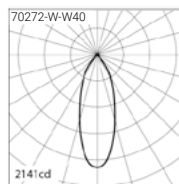
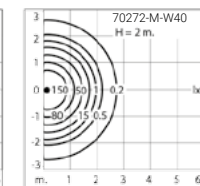
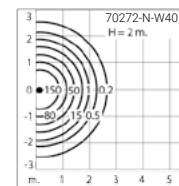
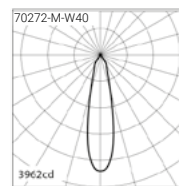
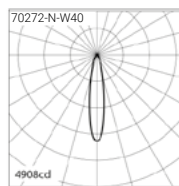
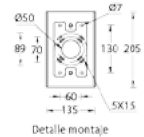
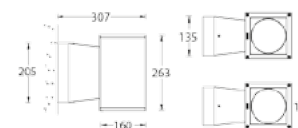

NEAL

Luminarias de superficie

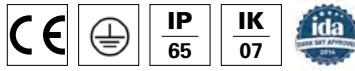

Apliques de pared de superficie limpios y lindos con un rendimiento líder en su clase. Aún con su forma minimalista, es la herramienta de iluminación más potente y flexible de su tipo, que ofrece paquetes de hasta 4000 lúmenes y varias opciones de óptica de calle.



Código de color de luminaria

-01 Negro	-02 Gris Oscuro	-03 Blanco	-05 Plata Mate	-06 Bronce
RAL 9011	RAL 7043	RAL 9003	RAL 9006	RAL 6014



Estructura de luminaria

- Carcasa y marco de aluminio fundido a presión pretratados antes del recubrimiento en polvo que garantizan una alta resistencia a la corrosión
- Entrada de cable única
- Cableado a través de pedido para 70312, 70313, 70314, 70315
- Sujetadores de acero inoxidable en grado 316
- Junta de goma de silicona duradera
- Vidrio transparente templado
- Equipo de control integral

Símbolos de funciones



Símbolos de luz



NEAL Luminarias de superficie

Guía código producto

70310 - M - W - W30 - ND - 01

Óptica
Down Up

CCT

Tipo Dimm
Color Luminaria

Temperatura del Color
 W30 - 3000K
 W40 - 4000K

Tipo Regulación
 ND - No dimmable
 DI - Dimmable 1-10V
 DA - Dimmable DALI

Color Luminaria
 01 - Negro
 02 - Gris Oscuro
 03 - Blanco
 05 - Plata Mate
 06 - Bronce

Código	Chip	Potencia	Lumen	EEC	Peso	Óptica						CCT	Electrónica		
						M	W	EW	T2	T3	T4			ME	
Down & Up - Cuadrado															
NEAL 1	70310	2 x 4 LED	15 W	1590 lm	A+	1.1 kg	30°	56°	99°x102°	129°x49°	112°x80°	89°x60°	122°x50°	W 30 40	ND
Down - Cuadrado															
NEAL 2	70311	4 LED	7.6 W	795 lm	A++	0.8 kg	30°	56°	99°x102°	129°x49°	112°x80°	89°x60°	122°x50°	W 30 40	ND
Down & Up - Rectangular															
NEAL 3	70312	2 x 8 LED	28 W	3320 lm	A++	1.8 kg	30°	56°	99°x102°	129°x49°	112°x80°	89°x60°	122°x50°	W 30 40	ND DI
NEAL 5	70314	2 x 12 LED	39 W	4844 lm	A++	2.0 kg	30°	56°	109°x102°	137°x58°	124°x86°	108°x66°	140°x62°	W 30 40	ND
Down - Rectangular															
NEAL 4	70313	8 LED	13.9 W	1660 lm	A++	1.5 kg	30°	56°	110°x103°	139°x55°	123°x85°	105°x69°	139°x60°	W 30 40	ND DI DA
NEAL 6	70315	12 LED	19.7 W	2422 lm	A++	1.8 kg	30°	56°	109°x102°	137°x58°	124°x86°	108°x66°	140°x62°	W 30 40	ND DI DA

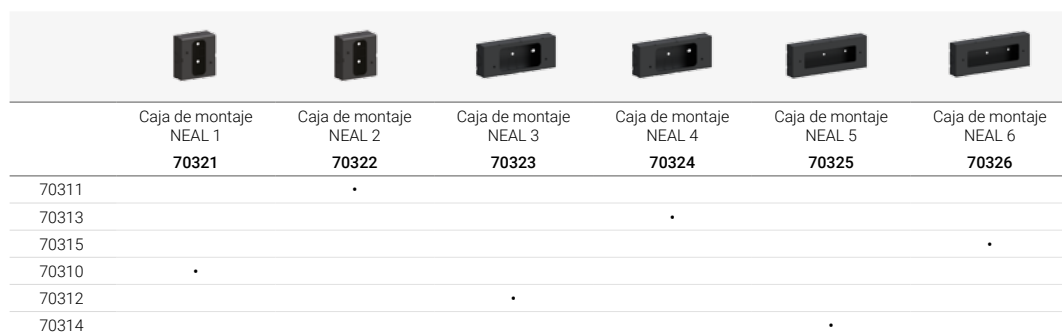

NEAL 1 Y 2

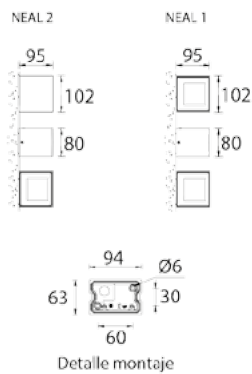

NEAL 3 Y 4

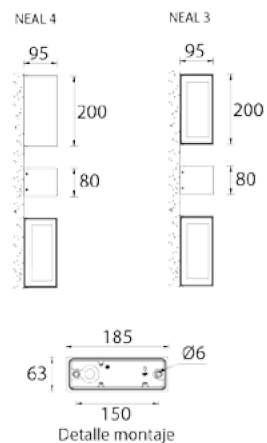

NEAL 5 Y 6

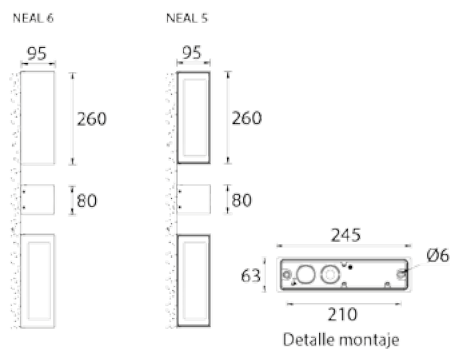



Accesorio de pastoreo superficial de pared. Luminaria de pared limpia y simple con óptica de pastoreo perfecta para resaltar texturas y colores.

HESTER

Luminarias de superficie

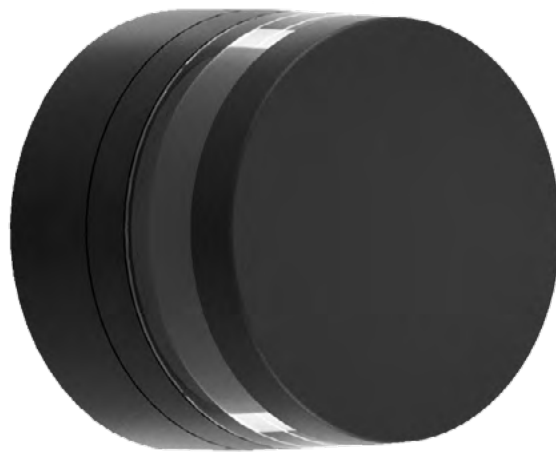

Código de color de luminaria

- 01	- 02	- 03	- 05	- 06
Negro	Gris Oscuro	Blanco	Plata Mate	Bronce
RAL 9011	RAL 7043	RAL 9003	RAL 9006	RAL 6014



Estructura de Luminaria

- Estructura y cuerpo de aluminio fundido a presión con alta resistencia a la corrosión
- Entrada de cable única
- Sujetadores de acero inoxidable en grado 316
- Junta de goma de silicona duradera
- Lente de policarbonato transparente, resistente a los impactos y estabilizada a los rayos UV
- Equipo de control integral

Símbolos de funciones

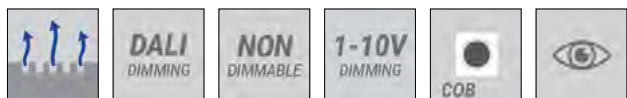

Símbolos de luz





G

HESTER Luminarias de superficie

Guía código producto	70670 - W30 - DI - 01	Temperatura del color W30 - 3000K W40 - 4000K	Tipo Regulación ND - No dimmable DI - Dimmable 1-10V DA - Dimmable DALI	Color Luminaria 01 - Negro 02 - Gris Oscuro 03 - Blanco 05 - Plata Mate 06 - Bronce
	<div style="display: flex; justify-content: space-around; align-items: center;"> <div style="border: 1px solid black; padding: 2px;">CCT</div> <div style="border: 1px solid black; padding: 2px;">Color Luminaria</div> </div> <div style="border: 1px solid black; padding: 2px; margin: 2px auto; width: 50px; text-align: center;">Tipo Dimm</div>			

	Código	Chip	Potencia	Lumen	EEC	Peso	Óptica	CCT	Electrónica
HESTER 3	70670	1 COB	20 W	260 - 285 lm	A++	1.9 kg	G	W 30 40	ND DI DA

	
Mascara 30°	Caja de montaje (HESTER 3)
70675	70676
70670	.



HESTER 3

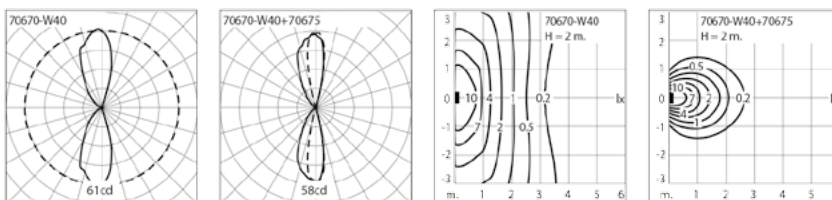
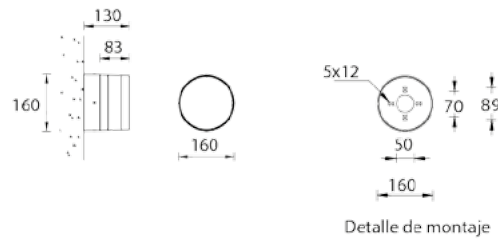



Luminaria de superficie cuadrada para iluminación arquitectónica. Familia de efectos de iluminación que sancionan la imaginación y la inspiración para reinar en los diseños.

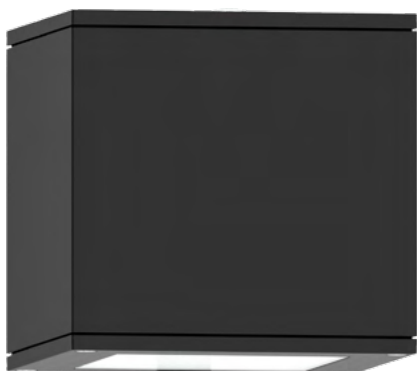

Código de color de luminaria

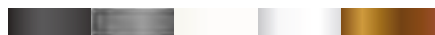

-01 Negro -02 Gris Oscuro -03 Blanco -05 Plata Mate -06 Bronce

RAL 9011 RAL 7043 RAL 9003 RAL 9006 RAL 6014

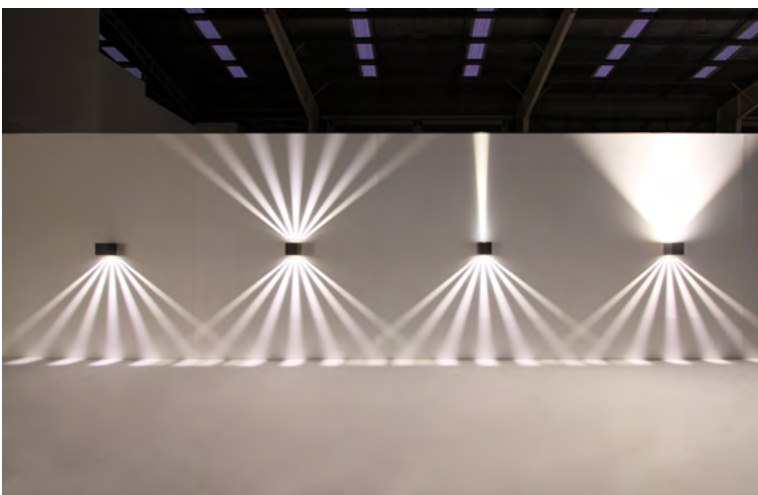

Estructura de Luminaria

- Carcasa de aluminio fundido a presión pretratada antes del recubrimiento en polvo que garantiza una alta resistencia a la corrosión
- Entrada de cable única
- Sujetadores de acero inoxidable en grado 316
- Junta de goma de silicona duradera
- Difusor de vidrio templado transparente, resistente a los impactos
- Equipo de control integral

Símbolos de funciones

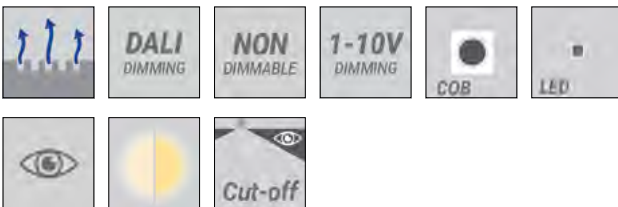

Símbolos de luz

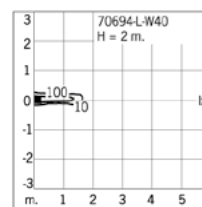
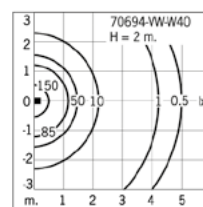
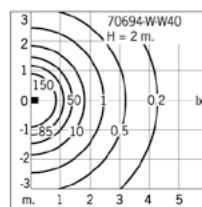
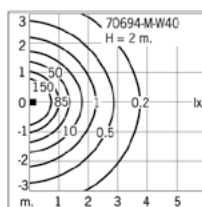
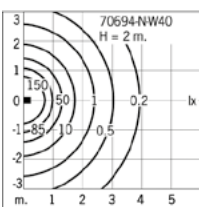
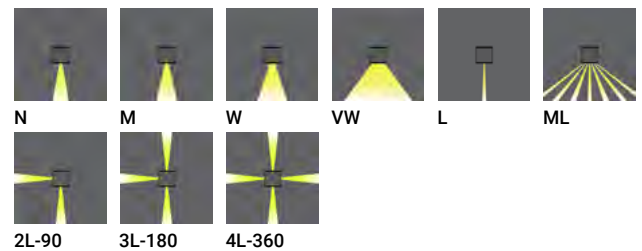

HUNTER Luminarias de superficie

Guía código producto

70690 - W - L - W30 - ND - 01

Óptica
Abajo | Arriba

CCT













Color Luminaria
Tipo Dimm

Temperatura del color
 W30 - 3000K
 W40 - 4000K

Tipo Regulación
 ND - No dimmable
 DI - Dimmable 1-10V
 DA - Dimmable DALI

Color Luminaria
 01 - Negro
 02 - Gris Oscuro
 03 - Blanco
 05 - Plata Mate
 06 - Bronce

Código	Chip	Potencia	Lumen	EEC	Peso	Óptica						CCT	Electrónica	
						N	M	W	VW	L	ML			
Down & Up														
HUNTER 1	70690	2 x 1 COB	20 W	158 - 1208 lm	A++	2.1 kg	20°	25°	36°	74°	5°	-	W 30 40	ND DI DA
HUNTER 2	70691	HIT-TC-CE 35W	35 W	240 lm	A	2.1 kg	-	-	-	-	5°	-	W 30 40	ND
	70692	2 x 1 COB	12 W	158 - 160 lm	A+	2.2 kg	-	-	-	-	5°	-	W 30 40	ND DI DA
HUNTER 3	70693	2 x 1 COB	28.6 W	2186 - 2256 lm	A++	2.2 kg	20°	25°	36°	74°	-	-	W 30 40	ND DI DA
Down														
HUNTER 4	70694	1 COB	14 W	1093 - 1128 lm	A++	2.2 kg	20°	25°	36°	74°	-	-	W 30 40	ND DI DA
HUNTER 5	70695	1 COB	6 W	79 - 80 lm	A+	2.2 kg	-	-	-	-	5°	-	W 30 40	ND DI DA
	70696	HIT-TC-CE 35W	35 W	120 lm	A	2.1 kg	-	-	-	-	5°	-	W 30 40	ND
Down & Up con 1 efecto de luz especial														
HUNTER 6	70697	1 COB & 1 LED	11 W	177 - 199 lm	A+	2.3 kg	-	-	-	-	5°	85°	W 30 40	ND DI DA
HUNTER 7	70698	1 COB & 1 LED	19 W	1191 - 1247 lm	A++	2.3 kg	20°	25°	36°	74°	-	85°	W 30 40	ND DI DA
Down & Up con 2 efectos de luz especial														
HUNTER 8	70699	2 x 1 LED	10 W	196 - 238 lm	A++	2.3 kg	-	-	-	-	-	85°	W 30 40	ND DI DA
Down & Up con 2 efectos de luz especiales														
HUNTER 9	70700	1 LED	5 W	98 - 119 lm	A++	2.3 kg	-	-	-	-	-	85°	W 30 40	ND DI DA
Distribuciones de luz L 2 lados (2L-90)														
HUNTER 10	70701	HIT-TC-CE 35W	35 W	240 lm	A	2.1 kg	-	-	-	-	5°	-	W 30 40	ND
Distribuciones de luz L 3 lados (3L-180)														
HUNTER 11	70702	HIT-TC-CE 35W	35 W	360 lm	A	2.1 kg	-	-	-	-	5°	-	W 30 40	ND
Distribuciones de luz L 4 lados L (4L-360)														
HUNTER 12	70703	HIT-TC-CE 35W	35 W	480 lm	A	2.1 kg	-	-	-	-	5°	-	W 30 40	ND

												
	Caja de montaje (HUNTER 1)	Caja de montaje (HUNTER 2)	Caja de montaje (HUNTER 3)	Caja de montaje (HUNTER 4)	Caja de montaje (HUNTER 5)	Caja de montaje (HUNTER 6)	Caja de montaje (HUNTER 7)	Caja de montaje (HUNTER 8)	Caja de montaje (HUNTER 9)	Caja de montaje (HUNTER 10)	Caja de montaje (HUNTER 11)	Caja de montaje (HUNTER 12)
	70710	70711	70712	70713	70714	70715	70716	70717	70718	70719	70720	70721
70690	.											
70697						.						
70698							.					
70691		.										
70692		.										
70699								.				
70696					.							
70701									.			
70702										.		
70693			.									
70694				.								
70695					.							
70700								.				
70703											.	

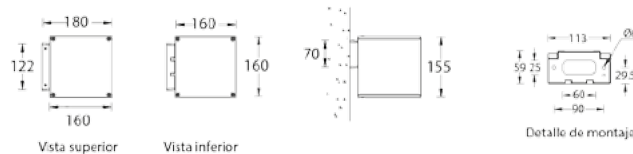

HUNTER





Gama de mamparos apantallados, circulares de pared. Familia exterior circular tradicional con muchas opciones atractivas de parilla y escudo.

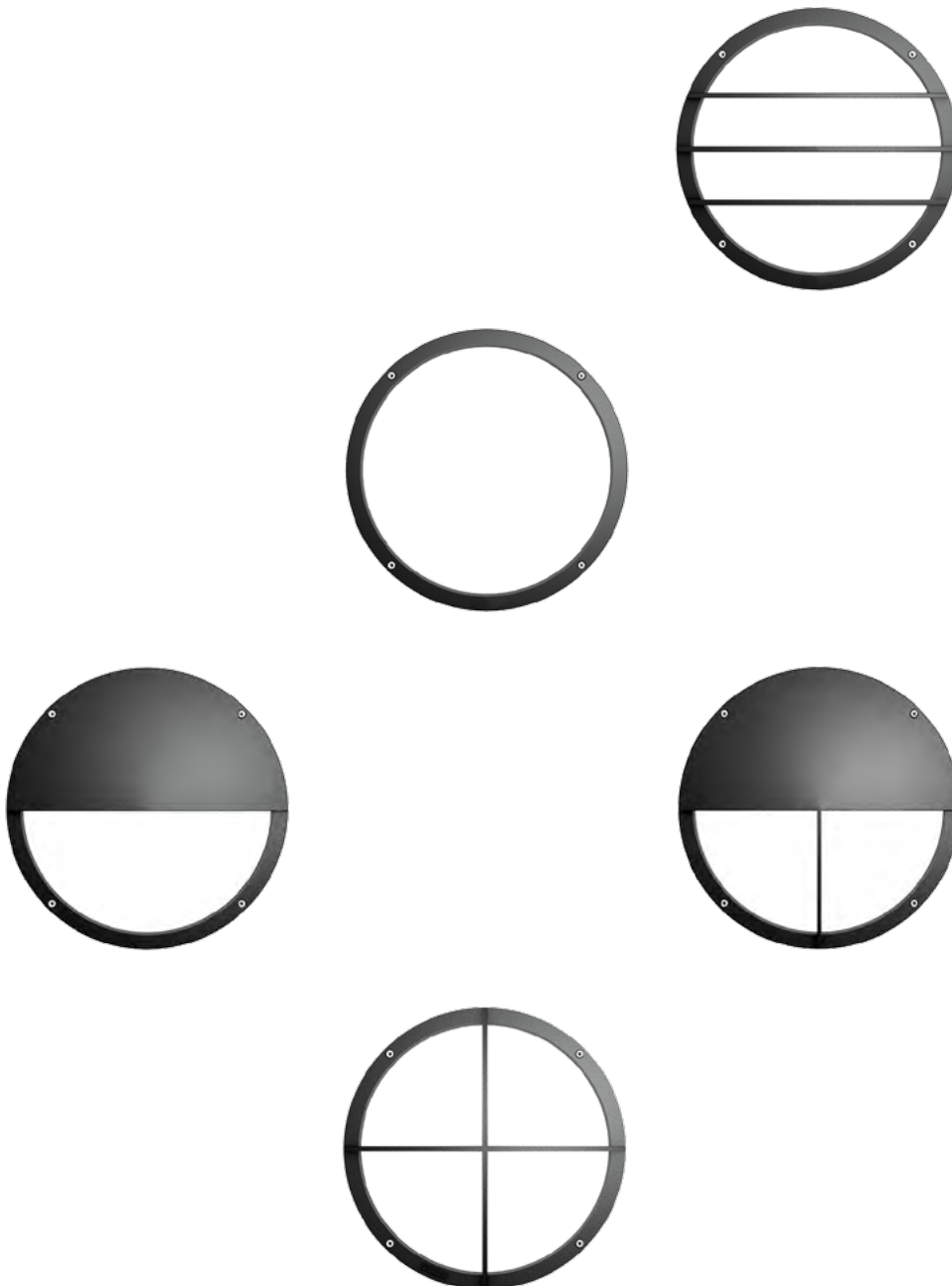

Código de color de luminaria

- 01 Negro	- 02 Gris Oscuro	- 03 Blanco	- 05 Plata Mate	- 06 Bronce
RAL 9011	RAL 7043	RAL 9003	RAL 9006	RAL 6014

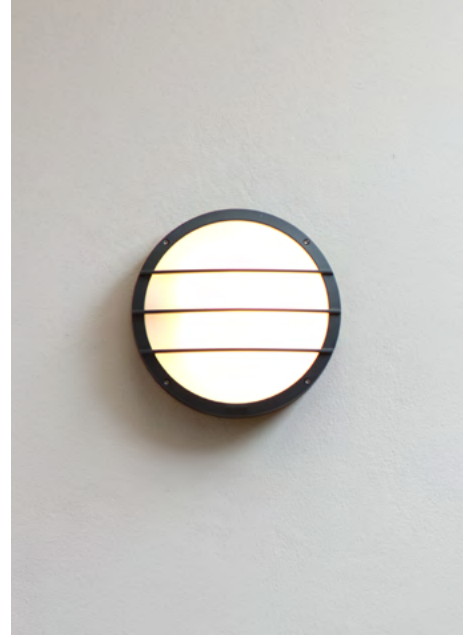

Estructura de luminaria

- Carcasa y marco de aluminio fundido a presión pretratados antes del recubrimiento en polvo que garantizan una alta resistencia a la corrosión
- Dos entradas de cable para cableado pasante
- Sujetadores de acero inoxidable en grado 316
- Junta de goma de silicona duradera
- Difusor de policarbonato opalino, resistente a los golpes y estabilizado a los rayos UV
- Equipo de control integral

Símbolos de funciones

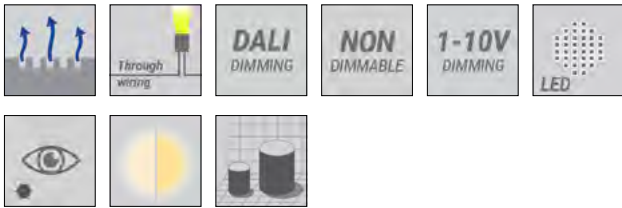

Símbolos de luz

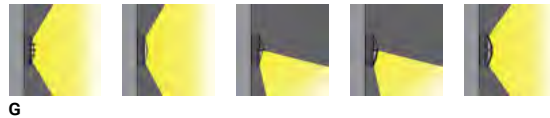







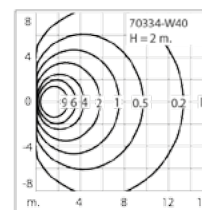
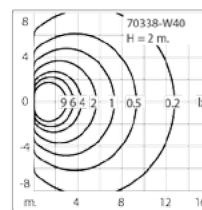
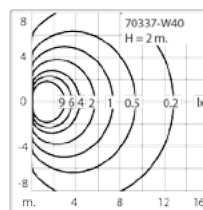
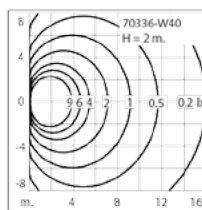
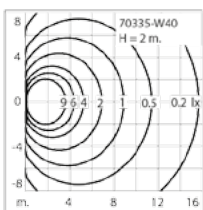

G

Guía código producto	70330 - W40 - DI - 01	Temperatura del Color W30 - 3000K W40 - 4000K	Tipo Regulación ND - No dimmable DI - Dimmable 1-10V DA - Dimmable DALI	Color Luminaria 01 - Negro 02 - Gris Oscuro 03 - Blanco 05 - Plata Mate 06 - Bronce
	<div style="display: flex; justify-content: space-around; align-items: center;"> <div style="text-align: center;">CCT</div> <div style="text-align: center;">Tipo Dimm</div> <div style="text-align: center;">Color Luminaria</div> </div>			

	Código	Chip	Potencia	Lumen	EEC	Peso	Óptica	CCT	Electrónica	
							G			
Pequeño										
	NALA 1	70330	40 LED	20 W	635 lm	A+	2.1 kg	114°x97°	W 30 40	ND DI DA
	NALA 2	70331	40 LED	20 W	810 lm	A+	2.0 kg	114°x113°	W 30 40	ND DI DA
	NALA 3	70332	40 LED	20 W	395 lm	A+	2.3 kg	114°x107°	W 30 40	ND DI DA
	NALA 4	70333	40 LED	20 W	347 lm	A+	2.3 kg	107°x107°	W 30 40	ND DI DA
	NALA 6	70334	40 LED	20 W	699 lm	A+	2.1 kg	108°x108°	W 30 40	ND DI DA
Grande										
	NALA 7	70335	50 LED	27 W	1161 lm	A+	4.0 kg	114°x102°	W 30 40	ND DI DA
	NALA 8	70336	50 LED	27 W	1315 lm	A+	3.8 kg	115°x114°	W 30 40	ND DI DA
	NALA 9	70337	50 LED	27 W	649 lm	A+	4.1 kg	115°x119°	W 30 40	ND DI DA
	NALA 10	70338	50 LED	27 W	623 lm	A+	4.1 kg	110°x109°	W 30 40	ND DI DA



NALA Luminarias de superficie

									
	Caja de montaje NALA 1	Caja de montaje NALA 2	Caja de montaje NALA 3	Caja de montaje NALA 4	Caja de montaje NALA 6	Caja de montaje NALA 7	Caja de montaje NALA 8	Caja de montaje NALA 9	Caja de montaje NALA 10
	70340	70341	70342	70343	70344	70345	70346	70347	70348
70330	.								
70331		.							
70332			.						
70333				.					
70334					.				
70335						.			
70336							.		
70337								.	
70338									.

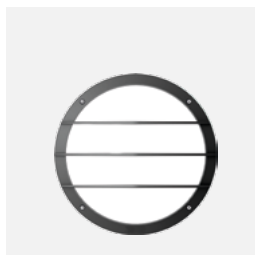

NALA 1

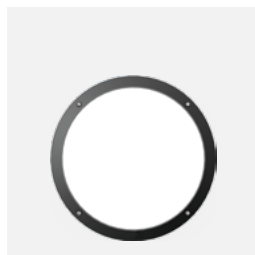

NALA 2

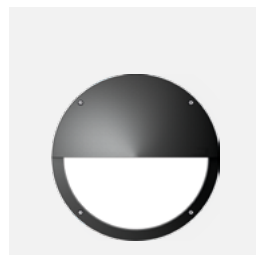

NALA 3

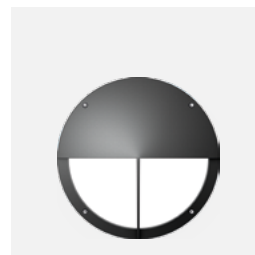

NALA 4

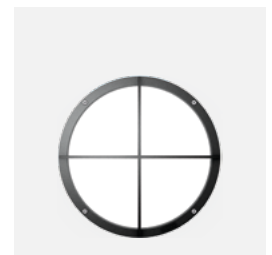

NALA 6

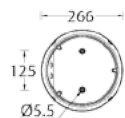
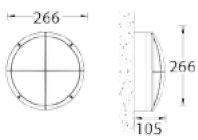
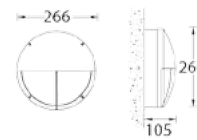
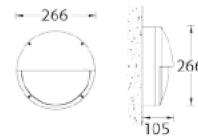
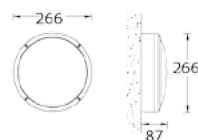
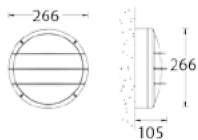

Detalle montaje

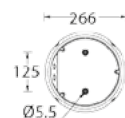

Detalle montaje

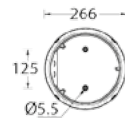

Detalle montaje

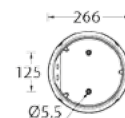

Detalle montaje

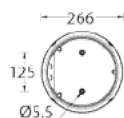

Detalle montaje

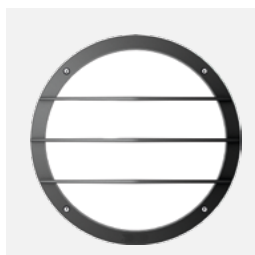

NALA 7

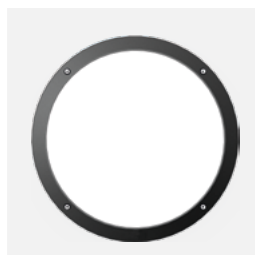

NALA 8



NALA 9



NALA 10

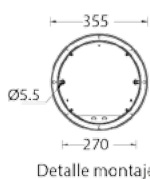
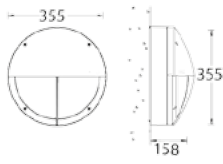
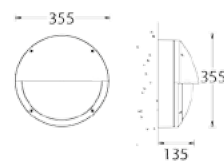
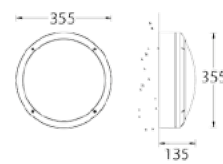
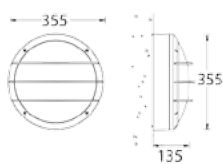

Detalle montaje

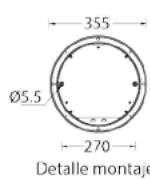

Detalle montaje

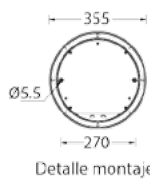

Detalle montaje

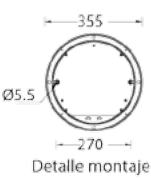

Detalle montaje

VALDUS

Luminarias de superficie



Luminarias flexibles de ambiente y reflectores de pared.
Soluciones elegantes, angulares, técnicas y potentes de
iluminación profesional.



Código de color de luminaria

-01 Negro	-02 Gris Oscuro	-03 Blanco	-05 Plata Mate	-06 Bronce
RAL 9011	RAL 7043	RAL 9003	RAL 9006	RAL 6014



Estructura de Luminaria

- Carcasa y marco de aluminio fundido a presión pretratados antes del recubrimiento en polvo que garantizan una alta resistencia a la corrosión
- Entrada de cable única
- Dos entradas de cable para cableado pasante bajo pedido para 70746, 70747, 70748, 70749
- Dos entradas de cable para cableado pasante de serie para 70730, 70731, 70732, 70733
- Sujetadores de acero inoxidable en grado 316
- Junta de goma de silicona duradera
- Lente de PMMA de alta eficiencia
- Difusor de vidrio templado transparente, resistente a los impactos
- Equipo de control integral

Símbolos de funciones



Símbolos de luz

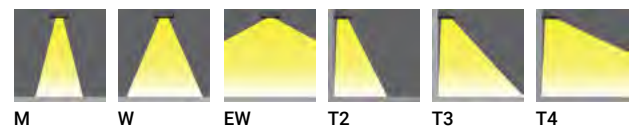

VALDUS Luminarias de superficie

Guía código producto

70730 - M - W30 - DI - 00

Óptica CCT Color Luminaria
Tipo Dimm

Temperatura del color
 W30 - 3000K
 W40 - 4000K

Tipo Regulación
 ND - No dimmable
 DI - Dimmable 1-10V
 DA - Dimmable DALI

Color Luminaria
 01 - Negro
 02 - Gris Oscuro
 03 - Blanco
 05 - Plata Mate
 06 - Bronce

Código	Chip	Potencia	Lumen	EEC	Peso	Óptica						CCT	Electrónica	
						M	W	EW	T2	T3	T4			
Medium														
VALDUS 1	70730	12 LED	20 W	2148 - 2446 lm	A++	3.2 kg	31°	53°	110°	144°x50°	139°x68°	97°x77°	W 30 40	ND DI DA
	70731	12 LED	28 W	2873 - 3330 lm	A+	3.2 kg	31°	53°	110°	144°x50°	139°x68°	97°x77°	W 30 40	ND
Large														
VALDUS 2	70732	24 LED	37 W	4509 - 5143 lm	A++	4.9 kg	32°	52°	108°	140°x51°	140°x72°	97°x82°	W 30 40	ND DI DA
	70733	24 LED	54 W	6104 - 6954 lm	A+	4.9 kg	32°	52°	108°	140°x51°	140°x72°	97°x82°	W 30 40	ND
Arm mounting - Medium														
VALDUS 7	70742	12 LED	20 W	2148 - 2473 lm	A++	5.5 kg	31°	53°	110°	144°x50°	139°x68°	97°x77°	W 30 40	ND DI DA
	70743	12 LED	28 W	2873 - 3330 lm	A+	5.5 kg	31°	53°	110°	144°x50°	139°x68°	97°x77°	W 30 40	ND DA
Montaje en brazo: grande														
VALDUS 8	70744	24 LED	37 W	4509 - 5143 lm	A++	7.5 kg	32°	52°	108°	140°x51°	140°x72°	97°x82°	W 30 40	ND DI DA
	70745	24 LED	54 W	6104 - 6954 lm	A+	7.5 kg	32°	52°	108°	140°x51°	140°x72°	97°x82°	W 30 40	ND
Caja de montaje - Mediana														
VALDUS 9	70746	12 LED	20 W	2148 - 2473 lm	A++	4.6 kg	31°	53°	110°	144°x50°	139°x68°	97°x77°	W 30 40	ND DI DA
	70747	12 LED	28 W	2873 - 3330 lm	A+	4.6 kg	31°	53°	110°	144°x50°	139°x68°	97°x77°	W 30 40	ND DA
Caja de montaje - Grande														
VALDUS 10	70748	24 LED	37 W	4509 - 5143 lm	A++	6.6 kg	32°	52°	108°	140°x51°	140°x72°	97°x82°	W 30 40	ND DI DA
	70749	24 LED	54 W	6104 - 6954 lm	A+	6.6 kg	32°	52°	108°	140°x51°	140°x72°	97°x82°	W 30 40	ND

Caja de montaje (VALDUS 1)	Caja de montaje (VALDUS 2)	Caja de montaje (VALDUS 7)	Caja de montaje (VALDUS 8)	Caja de montaje (VALDUS 9)	Caja de montaje (VALDUS 10)
70760	70761	70766	70767	70768	70769
70730	70732	70742	70744	70746	70748
70731	70733	70743	70745	70747	70749



VALDUS 1

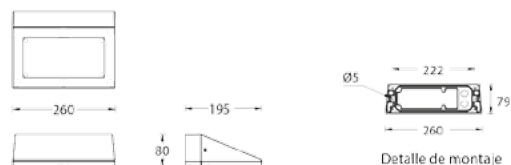

VALDUS 2

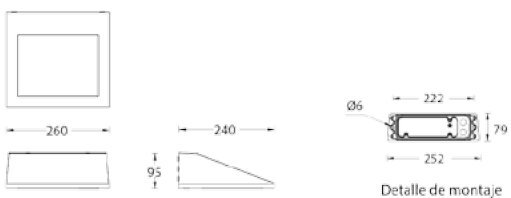

VALDUS 7

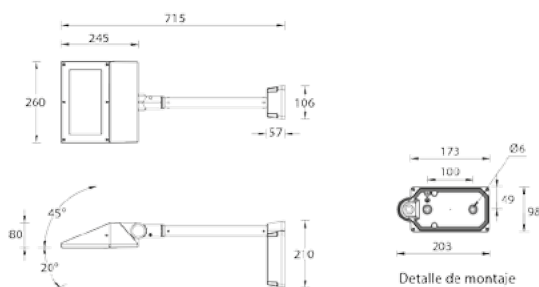

VALDUS Luminarias de superficie



VALDUS 8

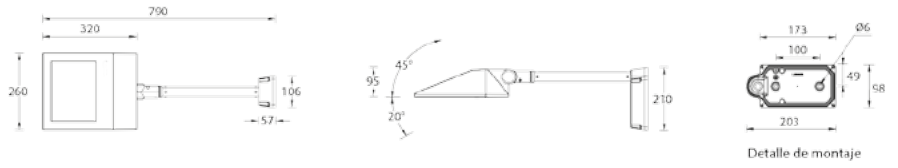

VALDUS 9

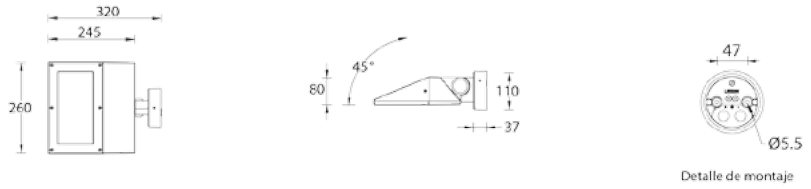

VALDUS 10

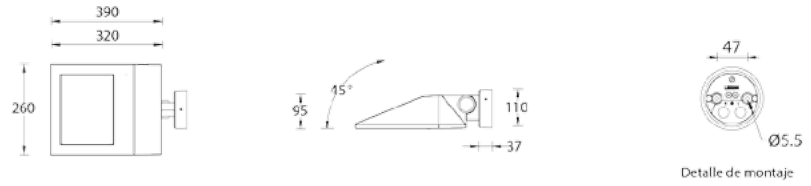

VALDUS 10 Brazo de montaje 40W con Óptica 32°

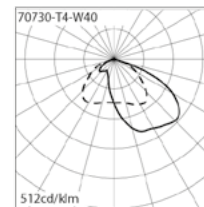
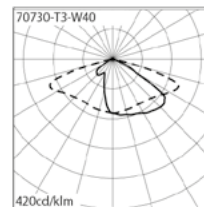
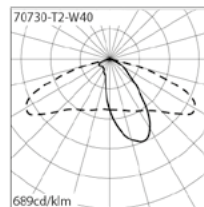
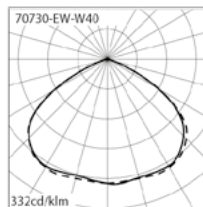
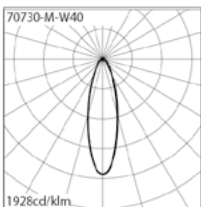

LUMINARIAS DE TECHO



GARRET
página 105



TAKEO
página 108



WINTER
página 111



TALA
página 115



TESSA
página 118



Downlight de superficie de forma cilíndrica o rectangular empotrado en el cielo raso. El alto rendimiento, los buenos resultados y las numerosas opciones garantizan que GARRET se pueda configurar para cualquier aplicación.



Código de color de luminaria

- 01	- 02	- 03	- 05	- 06
Negro	Gris Oscuro	Blanco	Plata Mate	Bronce
RAL 9011	RAL 7043	RAL 9003	RAL 9006	RAL 6014



Estructura de luminaria

- Carcasa de aluminio fundido a presión pretratada antes del recubrimiento en polvo que garantiza una alta resistencia a la corrosión
- Entrada de cable única
- Sujetadores de acero inoxidable en grado 316
- Junta de goma de silicona duradera
- Vidrio transparente templado
- Equipo de control integral

Símbolos de funciones



Símbolos de luz

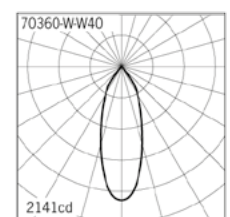
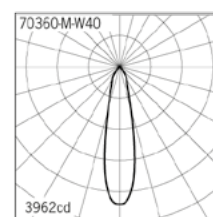
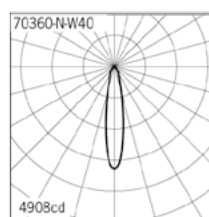
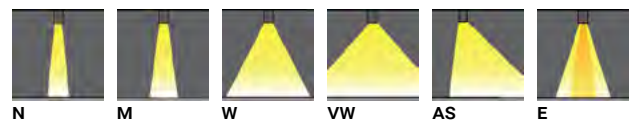

GARRET Luminarias de techo

Guía código producto

70360 - N - W30 - ND - 01

Óptica CCT Tipo Dimm Color Luminaria

Temperatura del Color
 W30 - 3000K
 W40 - 4000K

Tipo Regulación
 ND - No dimmable
 DI - Dimmable 1-10V
 DA - Dimmable DALI

Color Luminaria
 01 - Negro
 02 - Gris Oscuro
 03 - Blanco
 05 - Plata Mate
 06 - Bronce

Código	Chip	Potencia	Lumen	EEC	Peso	Óptica						CCT	Electrónica	
						N	M	W	VW	AS	E			
Ø102 - 232 mm - Redondo														
GARRET 39	70360	1 COB	14 W	949 - 1107 lm	A++	1.6 kg	20°	24°	36°	71°	-	-	W 30 40	ND DI DA
Ø102 - 140 mm - Redondo														
GARRET 39	70361	MR16-GU10	7.5 W	254 - 395 lm	A	0.7 kg	10°	25°	36°	60°	-	10°x60°	9030 9040	ND
102x102 mm - 232 mm - Cuadrado														
GARRET 40	70362	1 COB	14 W	949 - 1107 lm	A++	2.0 kg	20°	24°	36°	71°	-	-	W 30 40	ND DI DA
102x102 mm - 140 mm - Cuadrado														
GARRET 40	70363	MR16-GU10	7.5 W	254 - 395 lm	A	0.7 kg	10°	25°	36°	60°	-	10°x60°	9030 9040	ND
Ø160 - 296 mm - Redondo														
GARRET 41	70364	1 COB	39 W	2735 - 3494 lm	A++	3.1 kg	13°	20°	40°	61°	-	-	W 30 40	ND DI DA
Ø160 - 140 mm - Redondo														
GARRET 41	70365	1 COB	20 W	1700 - 2284 lm	A++	1.2 kg	22°	35°	52°	-	46°x56°	-	W 30 40	ND DI DA
160x160 mm - 296 mm - Cuadrado														
GARRET 42	70366	1 COB	39 W	2735 - 3494 lm	A++	3.9 kg	13°	20°	40°	61°	-	-	W 30 40	ND DI DA
160x160 mm - 140 mm - Cuadrado														
GARRET 42	70367	1 COB	20 W	1700 - 2284 lm	A++	1.2 kg	22°	35°	52°	-	46°x56°	-	W 30 40	ND DI DA

	70370	70371	70372	70373	70374
70360					
70362					
70364					
70365					
70366					
70367					
70361					
70363					



GARRET 39

GARRET 40

GARRET 41

GARRET 42

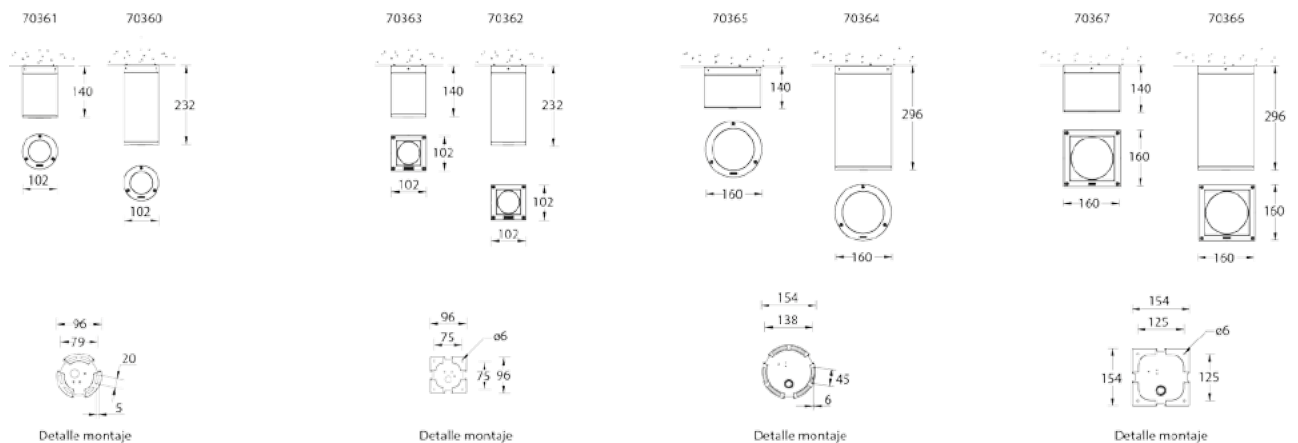





Luminarias de techo **TAKEO**



Downlights empotrables exteriores de cielo raso. Familia competitiva, técnica y bien construida de downlights empotrados de poca profundidad, compactos y poco profundos.



Código de color de luminaria

				
-01 Negro	-02 Gris Oscuro	-03 Blanco	-05 Plata Mate	-06 Bronce
RAL 9011	RAL 7043	RAL 9003	RAL 9006	RAL 6014



Estructura de Luminaria

- Carcasa de aluminio fundido a presión pretratada antes del recubrimiento en polvo que garantiza una alta resistencia a la corrosión
- Entrada de cable única
- Sujetadores de acero inoxidable en grado 316
- Junta de goma de silicona duradera
- Reflector Óptico de alta eficiencia.
- Vidrio transparente templado
- Equipo de control integral

Símbolos de funciones



Símbolos de luz

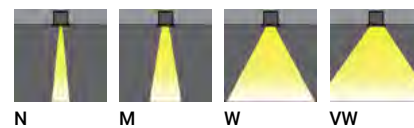

TAKEO Luminarias de techo

Guía código producto

70780 - N - W30 - DI - 01

Óptica

CCT

Tipo Dimm

Color Luminaria

Temperatura del Color

W30 - 3000K

W40 - 4000K

Tipo Regulación

ND - No dimmable

DI - Dimmable 1-10V

DA - Dimmable DALI

Color Luminaria

01 - Negro

02 - Gris Oscuro

03 - Blanco

05 - Plata Mate

06 - Bronce

Código	Chip	Potencia	Lumen	EEC	Peso	Óptica				CCT	Electrónica	
						N	M	W	VW			
Marco detector												
TAKEO 1	70780	1 COB	41 W	2963 - 3625 lm	A++	2.6 kg	13°	20°	40°	70°	W 30 40	ND DI DA
TAKEO 3	70782	1 COB	21 W	1726 - 1992 lm	A++	1.3 kg	20°	28°	39°	54°	W 30 40	ND DI DA
Marco plano												
TAKEO 2	70781	1 COB	41 W	2963 - 3625 lm	A++	2.5 kg	13°	20°	40°	70°	W 30 40	ND DI DA
TAKEO 4	70783	1 COB	21 W	1726 - 1992 lm	A++	1.2 kg	20°	28°	39°	54°	W 30 40	ND DI DA



TAKEO 1



TAKEO 2



TAKEO 3



TAKEO 4

TAKEO 1

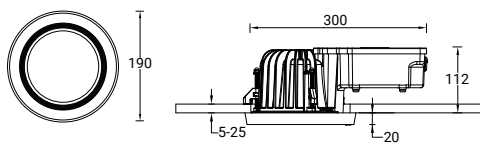

TAKEO 2

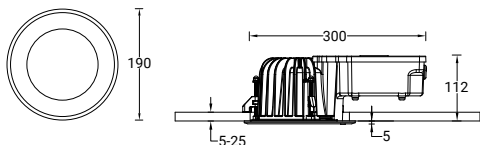

TAKEO 3

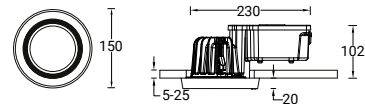

TAKEO 4

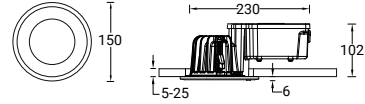

TAKEO 1, 2
Diámetro de corte Ø175mm.



TAKEO 3, 4
Diámetro de corte Ø140mm.

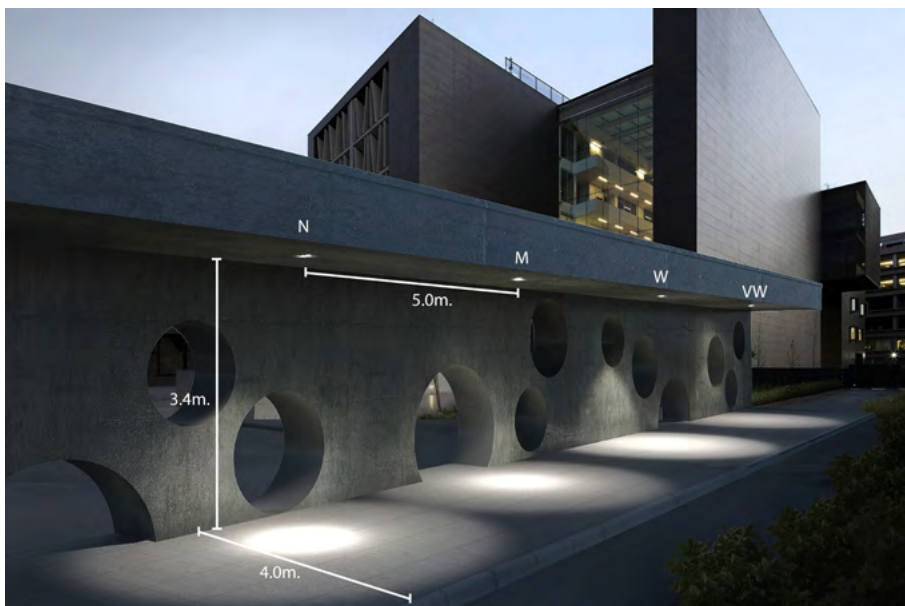

TAKEO 1
70780-W30
Beam: N/M/W/VW

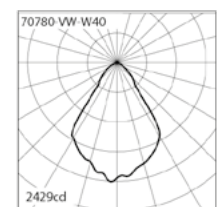
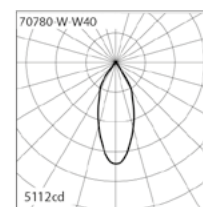
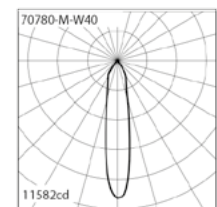
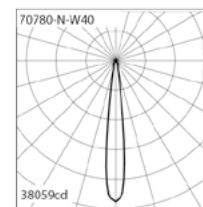



Downlights empotrables exteriores de cielo raso. La familia moderna, limpia y potente de downlights proporcionó al mercado las mejores soluciones resistentes de debajo del dosel.

WINTER

Luminarias de techo

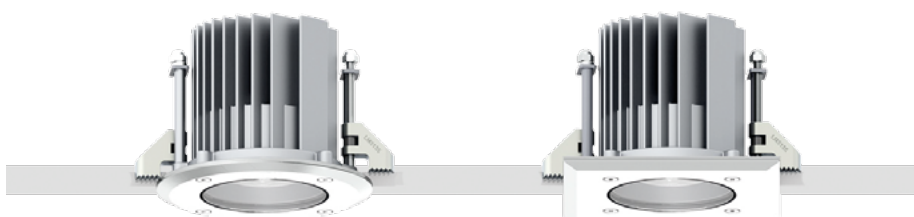

Código de color de luminaria

-01	-02	-03	-05	-06
Negro	Gris Oscuro	Bianco	Plata Mate	Bronce
RAL 9011	RAL 7043	RAL 9003	RAL 9006	RAL 6014



Estructura de luminaria

- Carcasa de aluminio fundido a presión pretratada antes del recubrimiento en polvo que garantiza una alta resistencia a la corrosión
- Aro frontal de 6 mm de espesor disponible en acero inoxidable o aluminio
- Entrada de cable única
- Sujetadores de acero inoxidable en grado 316
- Junta de goma de silicona duradera
- Vidrio transparente templado
- Incluye equipo de control para WINTER 5, WINTER 6
- Se incluye controlador remoto para WINTER 1, WINTER 2, WINTER 3, WINTER 4
- Caja IP remota incluida para WINTER 1, WINTER 2, WINTER 3, WINTER 4

Símbolos de funciones



Símbolos de luz

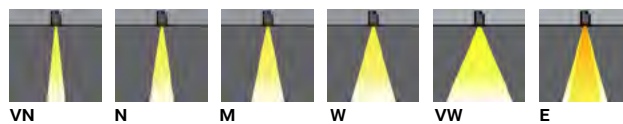

WINTER Luminarias de techo

<p>Guía código producto</p> <p>70380 - S - N - W30 - ND - 01</p> <p> Marco Óptica CCT Tipo Dimm Color Luminaria </p>	<p>Marco</p> <p>S - Marco Inox A - Marco Aluminio</p>	<p>Temperatura del color</p> <p>W30 - 3000K W40 - 4000K</p>	<p>Tipo Regulación</p> <p>ND - No dimmable DI - Dimmable 1-10V DA - Dimmable DALI</p>	<p>Color Luminaria</p> <p>01 - Negro 02 - Gris Oscuro 03 - Blanco 05 - Plata Mate 06 - Bronce</p>
--	--	--	--	--

Código	Chip	Potencia	Lumen	EEC	Peso	Óptica						CCT	Electrónica	
						VN	N	M	W	VW	E			
Con driver control remoto / Caja IP para remoto - Redondo - Marco aluminio														
WINTER 1	70380-A	7 LED	13 W	888 - 1045 lm	A++	0.5 kg	-	18°	28°	39°	-	-	W 30 40	ND DI DA
	70381-A	1 LED	11 W	640 - 753 lm	A++	0.5 kg	8°	-	-	-	-	-	W 30 40	ND DI DA
WINTER 3	70384-A	18 LED	29 W	2689 - 3144 lm	A+	2.3 kg	-	15°	27°	44°	-	-	W 30 40	ND DI DA
	70385-A	24 LED	39 W	3794 - 4303 lm	A+	2.3 kg	-	15°	26°	45°	-	-	W 30 40	ND DI DA
	70386-A	7 LED	33 W	3091 - 3320 lm	A++	2.3 kg	8°	-	-	-	-	-	W 30 40	ND DI DA
Con driver control remoto / Caja IP para remoto - Redondo - Marco acero inox														
WINTER 1	70380-S	7 LED	13 W	888 - 1045 lm	A++	0.7 kg	-	18°	28°	39°	-	-	W 30 40	ND DI DA
	70381-S	1 LED	11 W	640 - 753 lm	A++	0.7 kg	8°	-	-	-	-	-	W 30 40	ND DI DA
WINTER 3	70384-S	18 LED	29 W	2689 - 3144 lm	A+	2.6 kg	-	15°	27°	44°	-	-	W 30 40	ND DI DA
	70385-S	24 LED	39 W	3794 - 4303 lm	A+	2.6 kg	-	15°	26°	45°	-	-	W 30 40	ND DI DA
	70386-S	7 LED	33 W	3091 - 3320 lm	A++	2.6 kg	8°	-	-	-	-	-	W 30 40	ND DI DA
Con driver control remoto / Caja IP para remoto - Cuadrado - Marco aluminio														
WINTER 2	70382-A	7 LED	13 W	888 - 1045 lm	A++	0.6 kg	-	18°	28°	39°	-	-	W 30 40	ND DI DA
	70383-A	1 LED	11 W	640 - 753 lm	A++	0.6 kg	8°	-	-	-	-	-	W 30 40	ND DI DA
WINTER 4	70387-A	18 LED	29 W	2689 - 3144 lm	A+	2.5 kg	-	15°	27°	44°	-	-	W 30 40	ND DI DA
	70388-A	24 LED	39 W	3794 - 4303 lm	A+	2.8 kg	-	15°	26°	45°	-	-	W 30 40	ND DI DA
	70389-A	7 LED	33 W	3091 - 3320 lm	A++	2.8 kg	8°	-	-	-	-	-	W 30 40	ND DI DA
Con driver control remoto / Caja IP para remoto - Cuadrado - Marco acero inox														
WINTER 2	70382-S	7 LED	13 W	888 - 1045 lm	A++	0.8 kg	-	18°	28°	39°	-	-	W 30 40	ND DI DA
	70383-S	1 LED	11 W	640 - 753 lm	A++	0.8 kg	8°	-	-	-	-	-	W 30 40	ND DI DA
WINTER 4	70387-S	18 LED	29 W	2689 - 3144 lm	A+	2.8 kg	-	15°	27°	44°	-	-	W 30 40	ND DI DA
	70389-S	7 LED	33 W	3091 - 3320 lm	A++	2.8 kg	8°	-	-	-	-	-	W 30 40	ND DI DA
Con driver control remoto / Caja IP para remoto - Cuadrado - Marco acero inox														
WINTER 4	70388-S	24 LED	39 W	3794 - 4303 lm	A+	2.8 kg	-	15°	26°	45°	-	-	W 30 40	ND DI DA
Con driver - Redondo - Marco acero inox														
WINTER 5	70390-S	MR16-GU10	7.5 W	369 - 455 lm	A	0.6 kg	-	10°	25°	36°	60°	10°x60°	W 30 40	ND
Con driver - Cuadrado - Marco aluminio														
WINTER 6	70391-A	MR16-GU10	7.5 W	369 - 455 lm	A	0.5 kg	-	10°	25°	36°	60°	10°x60°	W 30 40	ND
Con driver - Cuadrado - Marco acero inox														
WINTER 6	70391-S	MR16-GU10	7.5 W	369 - 455 lm	A	0.6 kg	-	10°	25°	36°	60°	10°x60°	W 30 40	ND
Con driver - Redondo - Marco aluminio														
WINTER 5	70390-A	MR16-GU10	7.5 W	369 - 455 lm	A	0.5 kg	-	10°	25°	36°	60°	10°x60°	W 30 40	ND



WINTER 1



WINTER 2



WINTER 1



WINTER 2

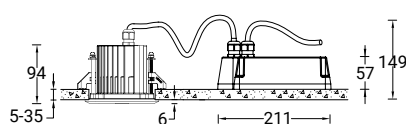

WINTER Luminarias de techo



WINTER 3



WINTER 4

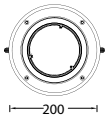

WINTER 3

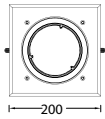

WINTER 4

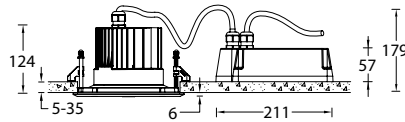

WINTER 5



WINTER 6

WINTER 120mm. (MR16/GU10)

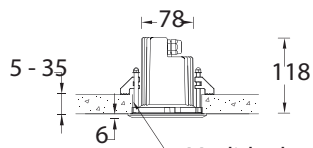
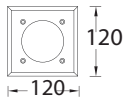
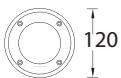

Medida de corte $\varnothing 106\text{mm}$.

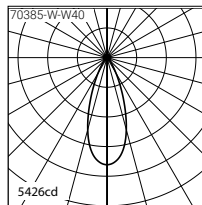
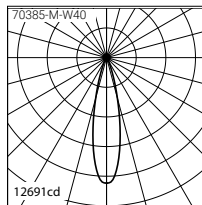
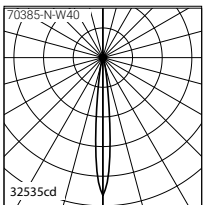



Downlights decorativos de superficie empotrados en el cielo raso. La familia naturalmente hermosa y única, TALA posee una gran cantidad de opciones y accesorios.

TALA

Luminarias de techo



Código de color de luminaria

-01	-02	-03	-05	-06
Negro	Gris Oscuro	Bianco	Plata Mate	Bronce
RAL 9011	RAL 7043	RAL 9003	RAL 9006	RAL 6014



Estructura de Luminaria

- Carcasa de aluminio fundido a presión pretratada antes del recubrimiento en polvo que garantiza una alta resistencia a la corrosión
- Entrada de cable única
- Sujetadores de acero inoxidable en grado 316
- Junta de goma de silicona duradera
- Reflector Óptico de alta eficiencia.
- Vidrio transparente templado
- Equipo de control integral

Símbolos de funciones



Símbolos de luz

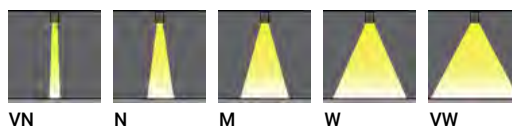

TALA Luminarias de techo

<p>Guía código producto</p> <p>70790 - N - W30 - DI - 01</p> <p> Óptica CCT Tipo Dimm Color Luminaria </p>	<p>Temperatura del Color</p> <p>W30 - 3000K W40 - 4000K</p>	<p>Tipo Regulación</p> <p>ND - No dimmable DI - Dimmable 1-10V DA - Dimmable DALI</p>	<p>Color Luminaria</p> <p>01 - Negro 02 - Gris Oscuro 03 - Blanco 05 - Plata Mate 06 - Bronce</p>
--	---	---	---

Código	Chip	Potencia	Lumen	EEC	Peso	Óptica					CCT	Electrónica	
						VN	N	M	W	VW			
Pequeño													
TALA 1	70790	1 COB	21 W	1653 - 1688 lm	A++	1.7 kg	-	-	23°	32°	43°	W 30 40	ND DI DA
	70791	1 LED	11 W	694 - 816 lm	A+	1.7 kg	8°	-	-	-	-	W 30 40	ND DI DA
Mediano													
TALA 2	70792	1 COB	36 W	2938 - 3458 lm	A++	2.3 kg	-	18°	27°	47°	70°	W 30 40	ND DA
	70793	3 LED	27 W	1704 - 2005 lm	A+	2.3 kg	8°	-	-	-	-	W 30 40	ND DA

	Lente extension lineal	Lumbrea panel abeja	Visera antideslumbrante	Lente extension lineal	Lumbrera antideslumbrante	Visera antideslumbrante
	70796	70797	70798	70799	70800	70801
70790		•		•		•
70791		•		•		•
70792	•		•		•	
70793	•		•		•	



TALA 1

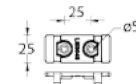
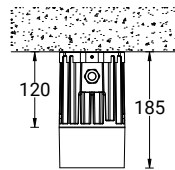
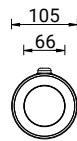

Detalle de montaje



TALA 2

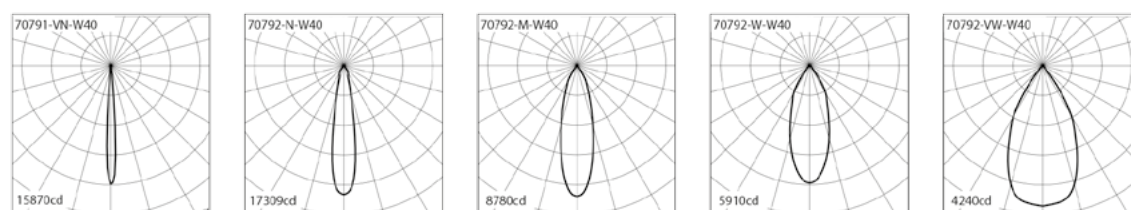
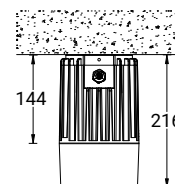
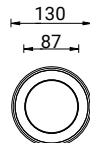

* TALA PEQUEÑO, la lente de extensión lineal y el panel de abeja no se pueden combinar, seleccione solo una.

* TALA MEDIANO, visera antideslumbrante, rejilla antideslumbrante y lente de extensión lineal no se pueden combinar, seleccione solo una.



Gama de downlights técnica de forma circular o cuadrada de superficie de cielo raso. Soluciones ópticas de iluminación completamente instalables en el cielo raso para una tarea perfecta o iluminación arquitectónica.



Código de color de luminaria

-01 Negro	-02 Gris Oscuro	-03 Blanco	-05 Plata Mate	-06 Bronce
RAL 9011	RAL 7043	RAL 9003	RAL 9006	RAL 6014



Estructura de luminaria

- Carcasa de aluminio fundido a presión pretratada antes del recubrimiento en polvo que garantiza una alta resistencia a la corrosión
- Entrada de cable única
- Sujetadores de acero inoxidable en grado 316
- Reflector Óptica de alta eficiencia.
- Junta de goma de silicona duradera
- Vidrio transparente templado
- Equipo de control integral

Símbolos de funciones



Símbolos de luz

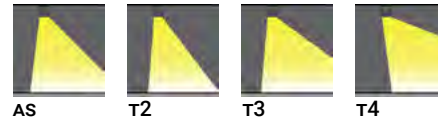

TESSA Luminarias de techo

<p>Guía código producto</p> <p>70401 - AS - W30 - ND - 01</p> <p> Óptica CCT Tipo Dimm Color Luminaria </p>	<p>Temperatura del color W30 - 3000K W40 - 4000K</p>	<p>Tipo Regulación ND - No dimmable DI - Dimmable 1-10V DA - Dimmable DALI</p>	<p>Color Luminaria 01 - Negro 02 - Gris Oscuro 03 - Blanco 05 - Plata Mate 06 - Bronce</p>
---	---	---	---

Código	Chip	Potencia	Lumen	EEC	Peso	Óptica				CCT	Electrónica	
						AS	T2	T3	T4			
Redonda												
TESSA 33	70400	16 LED	37 W	2427 - 2777 lm	A+	3.7 kg	-	140°x 46°	140°x 68°	91°x 76°	W 30 40	ND DI DA
	70401	1 COB	29 W	2535 - 2566 lm	A++	3.7 kg	46°x 56°	-	-	-	W 30 40	ND DI DA
	70402	1 COB	42 W	3377 - 3418 lm	A++	3.7 kg	46°x 56°	-	-	-	W 30 40	ND DA
Cuadrada												
TESSA 34	70403	16 LED	37 W	2417 - 2777 lm	A+	4.5 kg	-	140°x 46°	140°x 68°	91°x 76°	W 30 40	ND DI DA
	70404	1 COB	29 W	2535 - 2566 lm	A++	4.5 kg	46°x 56°	-	-	-	W 30 40	ND DI DA
	70405	1 COB	42 W	3377 - 3418 lm	A++	4.5 kg	46°x 56°	-	-	-	W 30 40	ND DA

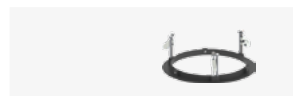

Anillo de montaje semiempotrado

70408

70400	•
70401	•
70402	•



TESSA 33

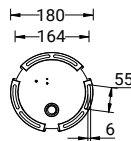
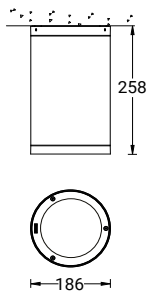

Detalle montaje

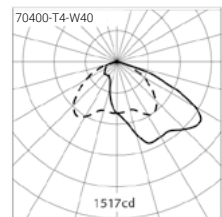
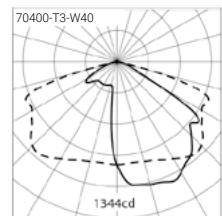
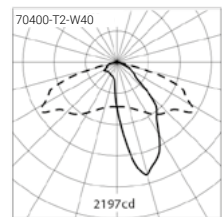

TESSA 34

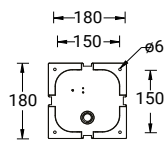
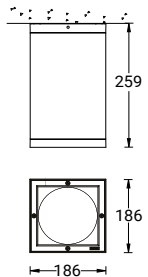

Detalle montaje



TESSA 33
70400-T2-W30

LUMINARIAS SUSPENSIÓN



DAISY
página 122



VELMA
página 125



GIA
página 128



PAYTON
página 131



GARRET
página 135



Familia de luminarias colgantes de vecindario urbano clásico. Líneas atemporales combinadas con una calidad de construcción, flexibilidad y rendimiento inigualables.



DAISY

Luminarias de suspensión

Código de color de luminaria

				
-01 Negro	-02 Gris Oscuro	-03 Blanco	-05 Plata Mate	-06 Bronce
RAL 9011	RAL 7043	RAL 9003	RAL 9006	RAL 6014



Estructura de Luminaria

- Varilla colgante de acero galvanizado pintado
- Carcasa de aluminio fundido a presión pretratada antes del recubrimiento en polvo que garantiza una alta resistencia a la corrosión
- Dos entradas de cable para cableado pasante
- Sujetadores de acero inoxidable en grado 316
- Junta de goma de silicona duradera
- Difusor de cristal opal
- Equipo de control integral

Símbolos de funciones



Símbolos de luz

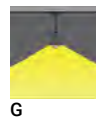

DAISY Luminarias de suspensión

<p>Guía código producto</p> <p>70810 - 1 - 1 - W30 - DI - 01</p> <p>Difusor Cúpula CCT Color Luminaria</p> <p>Tipo Dimm</p>	<p>Tipo difusor</p> <p>1 - Curvo</p> <p>2 - Cónico</p> <p>Estilo de cúpula</p> <p>1 - Redonda</p> <p>2 - Cónica</p>	<p>Temperatura del color</p> <p>W30 - 3000K</p> <p>W40 - 4000K</p>	<p>Tipo Regulación</p> <p>ND - No dimmable</p> <p>DI - Dimmable 1-10V</p> <p>DA - Dimmable DALI</p>	<p>Color Luminaria</p> <p>01 - Negro</p> <p>02 - Gris Oscuro</p> <p>03 - Blanco</p> <p>05 - Plata Mate</p> <p>06 - Bronce</p>
--	---	--	---	---

Código	Chip	Potencia	Lumen	EEC	Peso	Óptica	CCT	Electrónica	
						G			
Difusor curvo - Cúpula redonda									
DAISY 13	70810-1-1	1 COB	41 W	2449 - 2479 lm	A++	9.2 kg	134°	W 30 40	ND DI DA
Difusor curvo - Cúpula cónica									
DAISY 13	70810-1-2	1 COB	41 W	2449 - 2479 lm	A++	9.2 kg	134°	W 30 40	ND DI DA
Difusor cónico - Cúpula redonda									
DAISY 13	70810-2-1	1 COB	41 W	2601 - 2632 lm	A++	9.2 kg	134°	W 30 40	ND DI DA
Difusor cónico - Cúpula cónica									
DAISY 13	70810-2-2	1 COB	41 W	2601 - 2632 lm	A++	9.2 kg	134°	W 30 40	ND DI DA

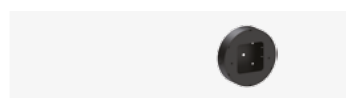

Caja de montaje (DAISY 13)

70812

70810-1-1	•
70810-1-2	•
70810-2-1	•
70810-2-2	•

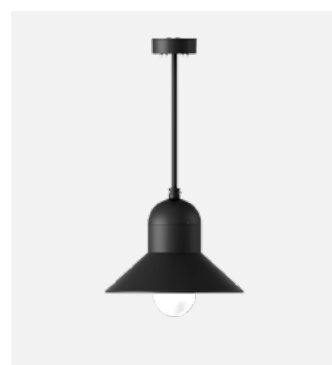

DAISY 13

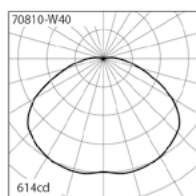
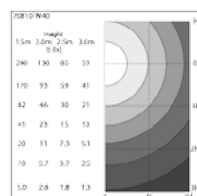
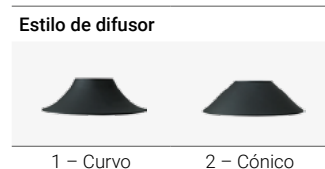
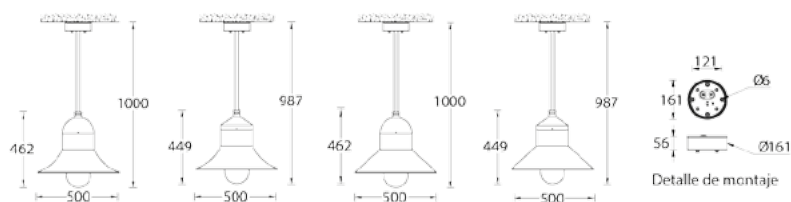



Colgante exterior clásico y económico. Forma urbana elegante con acento de luz lateral y tonos opcionales.



VELMA
Luminarias de suspensión

Código de color de luminaria

				
- 01 Negro	- 02 Gris Oscuro	- 03 Blanco	- 05 Plata Mate	- 06 Bronce
RAL 9011	RAL 7043	RAL 9003	RAL 9006	RAL 6014



Estructura de Luminaria

- Varilla colgante de acero galvanizado pintado
- Carcasa de aluminio fundido a presión pretratada antes del recubrimiento en polvo que garantiza una alta resistencia a la corrosión
- Dos entradas de cable para cableado pasante
- Sujetadores de acero inoxidable en grado 316
- Junta de goma de silicona duradera
- Difusor de cristal opal
- Equipo de control integral

Símbolos de funciones



Símbolos de luz



G

VELMA Luminarias de suspensión

<p>Guía código producto</p> <p>70474 - 1 - 1 - W30 - DI - 01</p> <p>Difusor Cúpula CCT Tipo Dimm Color Luminaria</p>	<p>Tipo difusor</p> <p>1 - Curvo 2 - Cónico</p> <p>Estilo de cúpula</p> <p>1 - Redonda 2 - Cónica</p>	<p>Temperatura del color</p> <p>W30 - 3000K W40 - 4000K</p>	<p>Tipo Regulación</p> <p>ND - No dimmable DI - Dimmable 1-10V DA - Dimmable DALI</p>	<p>Color Luminaria</p> <p>01 - Negro 02 - Gris Oscuro 03 - Blanco 05 - Plata Mate 06 - Bronce</p>
--	---	---	---	---

Código	Chip	Potencia	Lumen	EEC	Peso	Óptica	CCT	Electrónica	
							G		
Difusor curvo - Cúpula redonda									
VELMA 8	70474-1-1	1 COB	41 W	2156 - 2182 lm	A++	9.4 kg	149°	W 30 40	ND DI DA
Difusor curvo - Cúpula cónica									
VELMA 8	70474-1-2	1 COB	41 W	2156 - 2182 lm	A++	9.4 kg	149°	W 30 40	ND DI DA
Difusor cónico - Cúpula redonda									
VELMA 8	70474-2-1	1 COB	41 W	2156 - 2182 lm	A++	9.4 kg	149°	W 30 40	ND DI DA
Difusor cónico - Cúpula cónica									
VELMA 8	70474-2-2	1 COB	41 W	2156 - 2182 lm	A++	9.4 kg	149°	W 30 40	ND DI DA

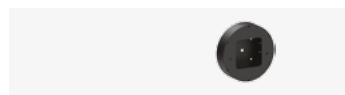

Caja de montaje (VELMA 8)

70478

70474-1-1	•
70474-1-2	•
70474-2-1	•
70474-2-2	•



VELMA 8

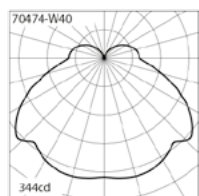
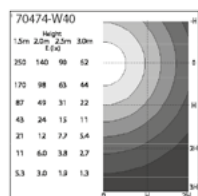
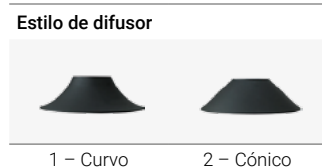
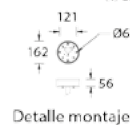
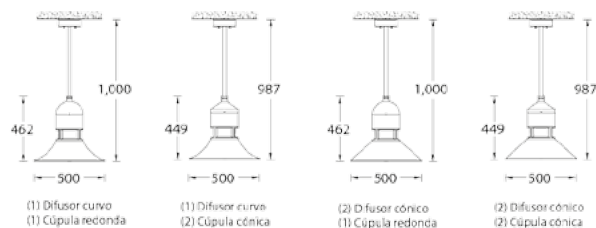

GIA

Luminarias de suspensión



Colgantes de superficie compactos, apantallados. Escala residencial, proporciona una suave iluminación ascendente y descendente.



Código de color de luminaria

-01 Negro	-02 Gris Oscuro	-03 Blanco	-05 Plata Mate	-06 Bronce
RAL 9011	RAL 7043	RAL 9003	RAL 9006	RAL 6014



Estructura de Luminaria

- Varilla colgante de acero galvanizado pintado
- Carcasa de aluminio fundido a presión pretratada antes del recubrimiento en polvo que garantiza una alta resistencia a la corrosión
- Dos entradas de cable para cableado pasante
- Sujetadores de acero inoxidable en grado 316
- Junta de goma de silicona duradera
- Difusor de cristal opal
- Equipo de control integral

Símbolos de funciones



Símbolos de luz



G

GIA Luminarias de suspensión

<p>Guía código producto</p> <p>70820 - 1 - 1 - W30 - DI - 01</p> <p>Difusor Cúpula CCT Color Luminaria</p> <p>Tipo Dimm</p>	<p>Tipo difusor</p> <p>1 - Curvo</p> <p>2 - Cónico</p> <p>Estilo de cúpula</p> <p>1 - Redonda</p> <p>2 - Cónica</p>	<p>Temperatura del color</p> <p>W30 - 3000K</p> <p>W40 - 4000K</p>	<p>Tipo Regulación</p> <p>ND - No dimmable</p> <p>DI - Dimmable 1-10V</p> <p>DA - Dimmable DALI</p>	<p>Color Luminaria</p> <p>01 - Negro</p> <p>02 - Gris Oscuro</p> <p>03 - Blanco</p> <p>05 - Plata Mate</p> <p>06 - Bronce</p>
--	---	--	---	---

Código	Chip	Potencia	Lumen	EEC	Peso	Óptica	CCT	Electrónica
						G		
Mediano - Difusor curvo - Cúpula redonda								
GIA 12	70820-1-1	1 COB	41 W	1635 - 1654 lm	A++	10.0 kg	129°	W 30 40 ND DI DA
Mediano - Difusor curvo - Cúpula cónica								
GIA 12	70820-1-2	1 COB	41 W	1635 - 1654 lm	A++	10.0 kg	129°	W 30 40 ND DI DA
Mediano - Difusor cónico - Cúpula redonda								
GIA 12	70820-2-1	1 COB	41 W	1763 - 1785 lm	A++	10.0 kg	129°	W 30 40 ND DI DA
Mediano - Difusor cónico - Cúpula cónica								
GIA 12	70820-2-2	1 COB	41 W	1763 - 1785 lm	A++	10.0 kg	129°	W 30 40 ND DI DA



Caja de montaje (GIA 12)

70822

70820-1-1	•
70820-1-2	•
70820-2-1	•
70820-2-2	•

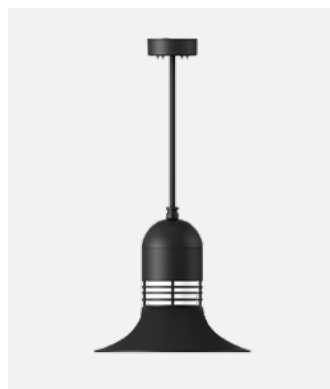

GIA 12

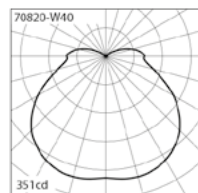
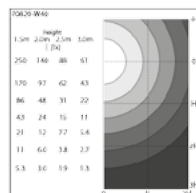
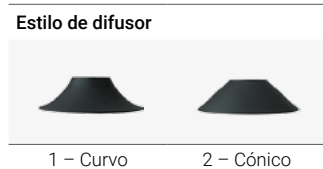
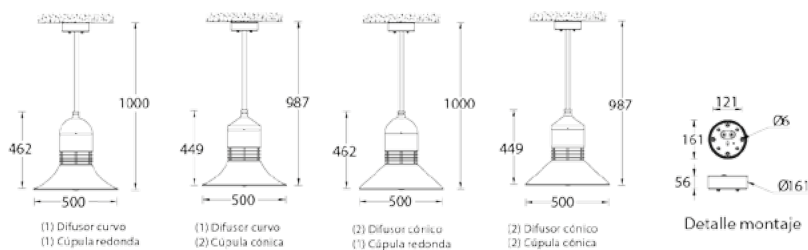



Su alta eficiencia cumple con el factor de forma clásica. Gaama completa de soluciones de iluminación decorativa de gran impacto con múltiples distribuciones de haces de luz y eficiencia superior.



PAYTON

Luminarias de suspensión

Código de color de luminaria

- 01 Negro	- 02 Gris Oscuro	- 03 Blanco	- 05 Plata Mate	- 06 Bronce
RAL 9011	RAL 7043	RAL 9003	RAL 9006	RAL 6014



Estructura de Luminaria

- Carcasa y marco de aluminio fundido a presión pretratados antes del recubrimiento en polvo que garantizan una alta resistencia a la corrosión
- Dos entradas de cable para cableado pasante
- Sujetadores de acero inoxidable en grado 316
- Junta de goma de silicona duradera
- Difusor de policarbonato opalino, resistente a los golpes y estabilizado a los rayos UV
- Tipo de distribución de luz hacia abajo sin lentes Ópticas externas
- Los modelos con pantalla tendrán un revestimiento de color blanco en el interior de la luminaria de sombra y un revestimiento de la superficie exterior según el color de la luminaria.
- Equipo de control integral

Símbolos de funciones



Símbolos de luz

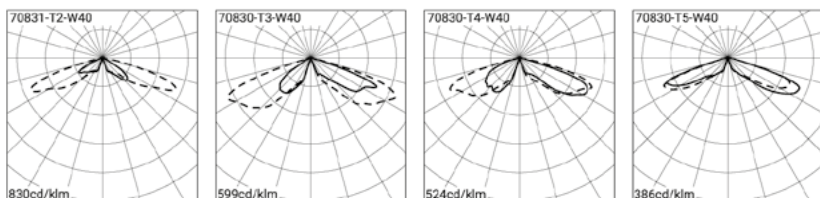
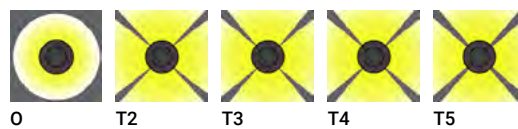

PAYTON Luminarias de suspensión

Guía código producto

70830 - T2 - W30 - ND - 01

Óptica CCT Tipo Dimm Color Luminaria









Óptica
 0 - Difusor Opal

Temperatura del color
 W30 - 3000K
 W40 - 4000K

Tipo Regulación
 ND - No dimmable
 DI - Dimmable 1-10V
 DA - Dimmable DALI

Color Luminaria
 01 - Negro
 02 - Gris Oscuro
 03 - Blanco
 05 - Plata Mate
 06 - Bronce

Código	Chip	Potencia	Lumen	EEC	Peso	Óptica					CCT	Electrónica	
						0	T2	T3	T4	T5			
Ø660 - 1045 mm - Parte superior plana con sombra													
PAYTON 25	70830	1 COB	47.5 W	4247 - 4813 lm	A++	8.3 kg	-	143°x86°	132°x99°	131°x117°	119°x134°	W 30 40	ND DI DA
	70831	4 x 40 LED	50.2 W	3903 - 4197 lm	A++	9.7 kg	360°	-	-	-	-	W 30 40	ND DI DA
Ø660 - 1045 mm - Parte superior plana con sombra con rejilla													
PAYTON 26	70832	1 COB	47.5 W	3413 - 3749 lm	A++	9.0 kg	-	143°x84°	141°x89°	129°x115°	143°	W 30 40	ND DI DA
	70833	4 x 40 LED	50.2 W	3046 - 3275 lm	A++	10.4 kg	360°	-	-	-	-	W 30 40	ND DI DA
Ø880 - 1194 mm - Parte superior plana con sombra													
PAYTON 27	70834	1 COB	69.6 W	6476 - 7522 lm	A++	13.5 kg	-	145°x87°	141°x91°	134°x118°	145°	W 30 40	ND DI DA
	70835	3 x 60 LED	60 W	4234 - 4553 lm	A++	15.0 kg	360°	-	-	-	-	W 30 40	ND DI DA
Ø880 - 1194 mm - Parte superior plana con sombra con rejilla													
PAYTON 28	70836	1 COB	69.6 W	5976 - 6603 lm	A++	14.3 kg	-	145°x84°	126°x106°	133°x116°	163°	W 30 40	ND DI DA
	70837	3 x 60 LED	60 W	3469 - 4053 lm	A++	15.9 kg	360°	-	-	-	-	W 30 40	ND DI DA
Ø508 - 1045 mm - Parte superior plana con sombra													
PAYTON 29	70838	1 COB	47.5 W	4221 - 4780 lm	A++	6.2 kg	-	142°x87°	131°x100°	128°x118°	161°	W 30 40	ND DI DA
	70839	4 x 40 LED	50.2 W	4237 - 4556 lm	A++	7.5 kg	360°	-	-	-	-	W 30 40	ND DI DA
Ø508 - 1045 mm - Parte superior plana con sombra con rejilla													
PAYTON 30	70840	1 COB	47.5 W	3191 - 3711 lm	A++	6.8 kg	-	140°x100°	132°x103°	137°x117°	73°	W 30 40	ND DI DA
	70841	4 x 40 LED	50.2 W	3279 - 3526 lm	A++	8.2 kg	360°	-	-	-	-	W 30 40	ND DI DA
Ø320 - 1179 mm - Parte superior plana con sombra													
PAYTON 31	70842	1 COB	69.6 W	7196 - 8415 lm	A++	9.6 kg	-	145°x87°	141°x91°	134°x118°	145°	W 30 40	ND DI DA
	70843	3 x 60 LED	60 W	4234 - 4553 lm	A++	11.1 kg	360°	-	-	-	-	W 30 40	ND DI DA
Ø320 - 1179 mm - Parte superior plana con sombra con rejilla													
PAYTON 32	70844	1 COB	69.6 W	5976 - 6603 lm	A++	10.0 kg	-	145°x84°	126°x106°	133°x116°	163°	W 30 40	ND DI DA
	70845	3 x 60 LED	60 W	3469 - 4053 lm	A++	12.0 kg	360°	-	-	-	-	W 30 40	ND DI DA

								
	Caja de montaje (PAYTON 25)	Caja de montaje (PAYTON 26)	Caja de montaje (PAYTON 27)	Caja de montaje (PAYTON 28)	Caja de montaje (PAYTON 29)	Caja de montaje (PAYTON 30)	Caja de montaje (PAYTON 31)	Caja de montaje (PAYTON 32)
	70850	70851	70852	70853	70854	70855	70856	70857
70830	•							
70832		•						
70831	•							
70833		•						
70838					•			
70840						•		
70839					•			
70841							•	
70834			•					
70836				•				
70835			•					
70837				•				
70842							•	
70844								•
70843							•	
70845								•



PAYTON 25



PAYTON 26

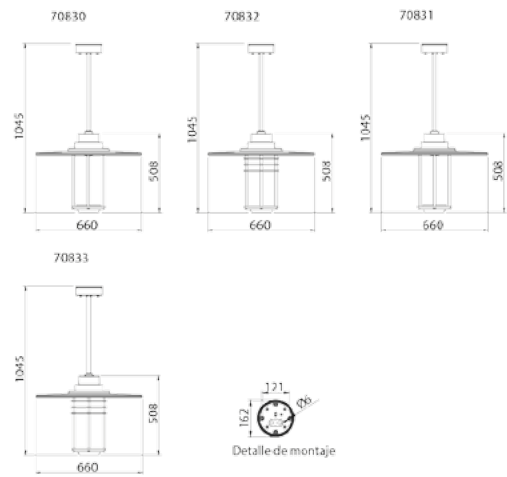

PAYTON 29



PAYTON 30

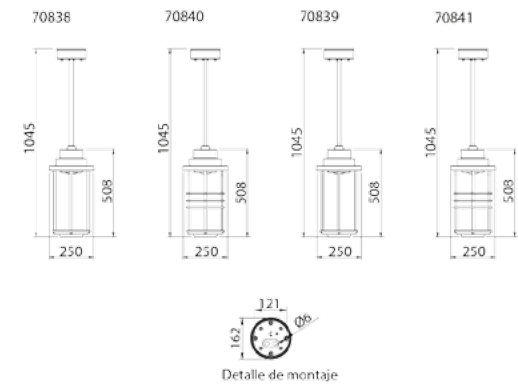

PAYTON 27



PAYTON 28

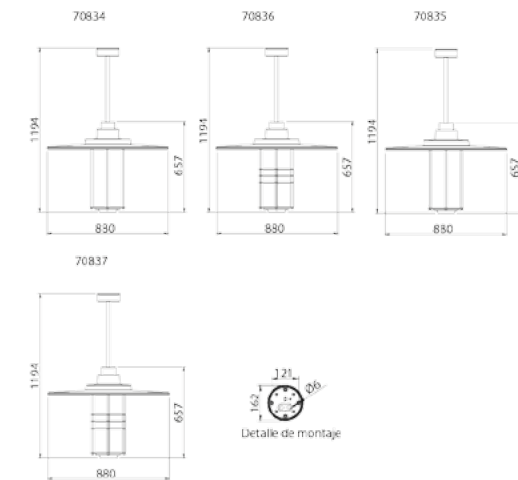

PAYTON 31



PAYTON 32

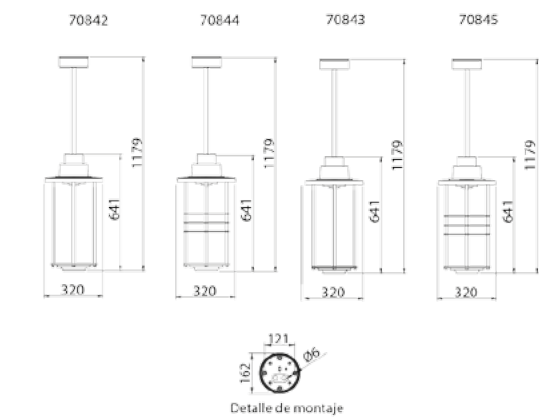





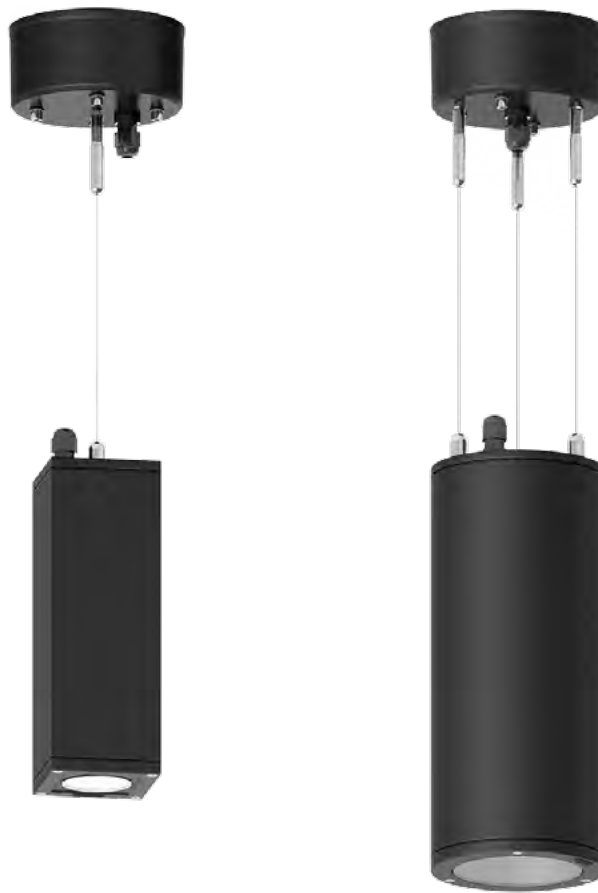

Downlight de forma cilíndrica o rectangular. El alto rendimiento, los buenos resultados y las numerosas opciones garantizan que GARRET pueda configurarse para cualquier aplicación.



GARRET

Luminarias de suspensión

Código de color de luminaria

				
- 01 Negro	- 02 Gris Oscuro	- 03 Blanco	- 05 Plata Mate	- 06 Bronce
RAL 9011	RAL 7043	RAL 9003	RAL 9006	RAL 6014



Estructura de Luminaria

- Carcasa de aluminio fundido a presión pretratada antes del recubrimiento en polvo que garantiza una alta resistencia a la corrosión
- Dos entradas de cable para cableado pasante
- Sujetadores de acero inoxidable en grado 316
- Kit de suspensión de acero inoxidable en grado 304
- Junta de goma de silicona duradera
- Vidrio transparente templado
- La altura de suspensión es totalmente ajustable
- Equipo de control integral

Símbolos de funciones



Símbolos de luz

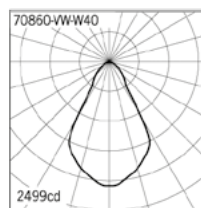
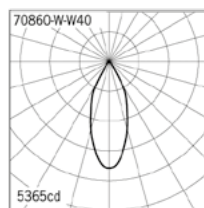
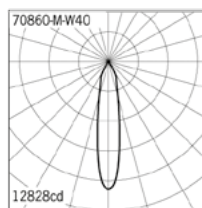
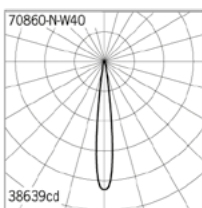

GARRET Luminarias de suspensión

Guía código producto

70860 - N - W30 - ND - 01

Óptica CCT Tipo Dimm Color Luminaria

Temperatura del Color
 W30 - 3000K
 W40 - 4000K

Tipo Regulación
 ND - No dimmable
 DI - Dimmable 1-10V
 DA - Dimmable DALI

Color Luminaria
 01 - Negro
 02 - Gris Oscuro
 03 - Blanco
 05 - Plata Mate
 06 - Bronce

Código	Chip	Potencia	Lumen	EEC	Peso	Óptica					CCT	Electrónica	
						N	M	W	VW	E			
Ø102 - 216 mm - Redondo													
GARRET 43	70860	1 COB	14 W	949 - 1107 lm	A++	1.8 kg	20°	24°	36°	71°	-	W 30 40	ND DI DA
	70861	MR16-GU10	7.5 W	254 - 395 lm	A	1.5 kg	10°	25°	36°	60°	10°x60°	W 30 40	ND
102x102 mm - 217 mm - Cuadrado													
GARRET 44	70862	1 COB	14 W	949 - 1107 lm	A++	2.4 kg	20°	24°	36°	71°	-	W 30 40	ND DI DA
	70863	MR16-GU10	7.5 W	254 - 395 lm	A	2.1 kg	10°	25°	36°	60°	10°x60°	W 30 40	ND
Ø160 - 278 mm - Redondo													
GARRET 45	70864	1 COB	39 W	2735 - 3494 lm	A++	3.4 kg	13°	20°	40°	61°	-	W 30 40	ND DI DA
160x160 mm - 281 mm - Cuadrado													
GARRET 46	70865	1 COB	39 W	2735 - 3494 lm	A++	4.6 kg	13°	20°	40°	61°	-	W 30 40	ND DI DA

	Caja de montaje (GARRET 43)	Caja de montaje (GARRET 44)	Caja de montaje (GARRET 45)	Caja de montaje (GARRET 46)
	70870	70871	70872	70873
70860	•			
70861	•			
70862		•		
70863		•		
70864			•	
70865				•



GARRET 43



GARRET 44



GARRET 45



GARRET 46

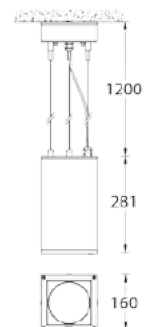
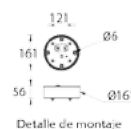
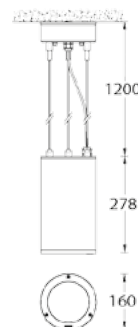
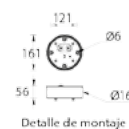
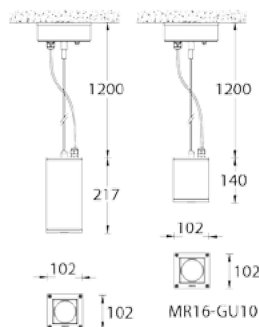
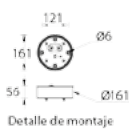
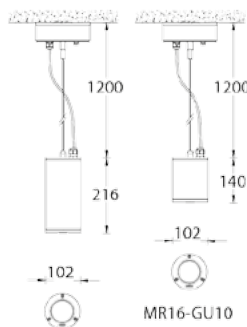

BOLARDOS



MAGNUS
página 139



DAISY
página 142



ERIN
página 145



VELMA
página 148



GIA
página 151



NORA
página 155



VELVET
página 158



JESSA
página 162



MARGOT
página 165



LIAM
página 168



MILO
página 171



ORSON
página 175



VALDUS
página 178



UMA
página 181



Versión de bolardo que se extiende en toda la gama de nuestra innovadora familia de muros. Hermosos y modernos accesorios empotrados en bolardos adecuados para cualquier ubicación.

MAGNUS

Bolardos



Código de color de luminaria

-01	-02	-03	-05	-06
Negro	Gris Oscuro	Blanco	Plata Mate	Bronce
RAL 9011	RAL 7043	RAL 9003	RAL 9006	RAL 6014



Estructura de Luminaria

- Carcasa de aluminio fundido a presión y columna de aluminio extruido pretratado antes del recubrimiento en polvo que garantizan una alta resistencia a la corrosión
- Entrada de cable única
- Un conector IP68 suministrado con 0,2 m de cable exterior de 3x1,0 mm²
- Sujetadores de acero inoxidable en grado 316
- Junta de goma de silicona duradera
- Difusor de vidrio esmerilado
- Equipo de control integral

Símbolos de funciones



Símbolos de luz



G

MAGNUS Bolardos

<p>Guía código producto</p> <p>70140 - W30 - ND - 01</p> <p>CCT Tipo Dimm Color Luminaria</p>	<p>Temperatura del Color</p> <p>W30 - 3000K W40 - 4000K</p>	<p>Tipo Regulación</p> <p>ND - No dimmable</p>	<p>Color Luminaria</p> <p>01 - Negro 02 - Gris Oscuro 03 - Blanco 05 - Plata Mate 06 - Bronce</p>
---	---	--	---

Código	Chip	Potencia	Lumen	EEC	Peso	Óptica	CCT	Electrónica
260x75 mm - 500 mm - 1 lado								
MAGNUS 4	70140	30 LED	11 W	765 - 783 lm	A++	5.7 kg	102°x 70°	W 30 40
MAGNUS 5	70144	30 LED	11 W	765 - 783 lm	A++	6.2 kg	102°x 70°	W 30 40
260x75 mm - 500 mm - 2 lados								
MAGNUS 4	70141	30 LED	22 W	1530 - 1566 lm	A++	7.0 kg	102°x 70°	W 30 40
MAGNUS 5	70145	30 LED	22 W	1530 - 1566 lm	A++	7.9 kg	102°x 70°	W 30 40
260x75 mm - 1000 mm - 1 lado								
MAGNUS 4	70142	30 LED	11 W	765 - 783 lm	A++	9.1 kg	102°x 70°	W 30 40
MAGNUS 5	70146	30 LED	11 W	765 - 783 lm	A++	9.1 kg	102°x 70°	W 30 40
260x75 mm - 1000 mm - 2 lados								
MAGNUS 4	70143	30 LED	22 W	1530 - 1566 lm	A++	10.2 kg	102°x 70°	W 30 40
MAGNUS 5	70147	30 LED	22 W	1530 - 1566 lm	A++	10.2 kg	102°x 70°	W 30 40



Perno de anclaje

70538

70140	•
70142	•
70141	•
70143	•
70144	•
70146	•
70145	•
70147	•

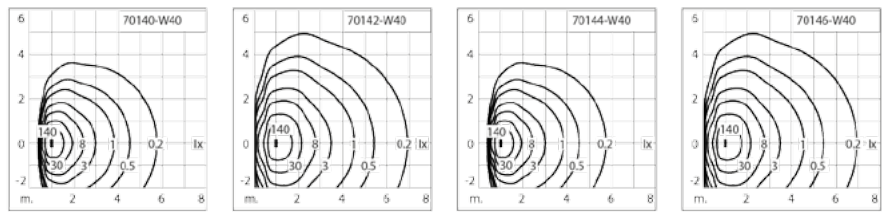

MAGNUS 4

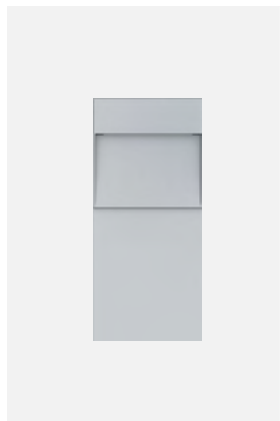
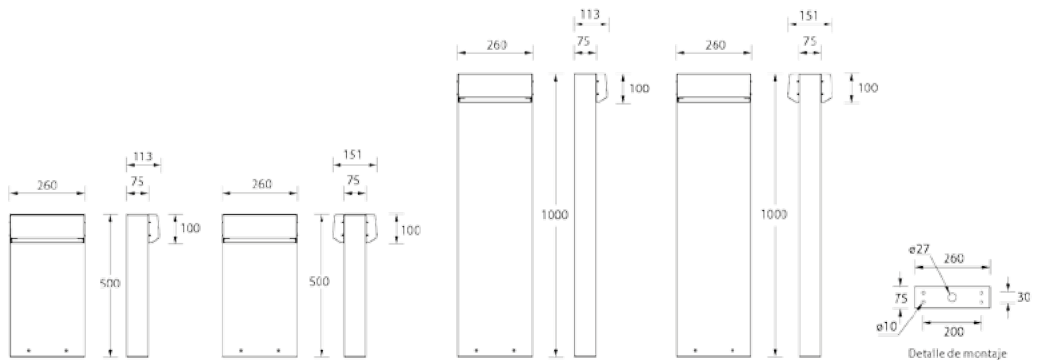

MAGNUS 5

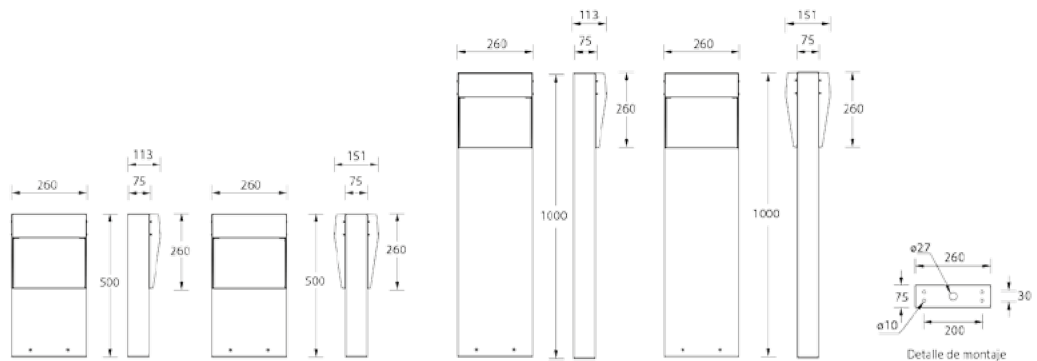

DAISY

Bolardos



Familia de luminarias de bolardos de barrio urbano clásico.
Líneas atemporales combinadas con una calidad de construcción, flexibilidad y rendimiento incomparables.



Código de color de luminaria

-01 Negro	-02 Gris Oscuro	-03 Blanco	-05 Plata Mate	-06 Bronce
RAL 9011	RAL 7043	RAL 9003	RAL 9006	RAL 6014



Estructura de luminaria

- Carcasa de aluminio fundido a presión y columna de aluminio extruido pretratado antes del recubrimiento en polvo que garantizan una alta resistencia a la corrosión
- Entrada de cable única
- Un conector IP68 suministrado con 0,2 m de cable exterior de 3x1,0 mm²
- Sujetadores de acero inoxidable en grado 316
- Junta de goma de silicona duradera
- Difusor de cristal opal
- Equipo de control integral

Símbolos de funciones



Símbolos de luz

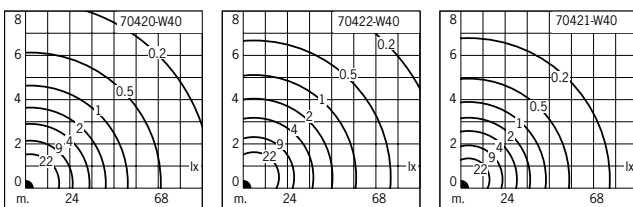

Guía código producto

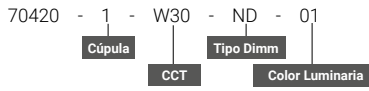

Estilo cúpula
1 - Redondeada
2 - Plana

Temperatura del color
W30 - 3000K
W40 - 4000K

Tipo Regulación
ND - No dimmable
DI - Dimmable 1-10V
DA - Dimmable DALI

Color Luminaria
01 - Negro
02 - Gris Oscuro
03 - Blanco
05 - Plata Mate
06 - Bronce

Código	Chip	Potencia	Lumen	EEC	Peso	Óptica	CCT	Electrónica	
Ø160 - 772 mm - Cúpula redondeada									
DAISY 1	70420-1	1 COB	41 W	1275 - 1454 lm	A++	6.8 kg	360°	W 30 40	ND DI DA
Ø160 - 752 mm - Cúpula plana									
DAISY 1	70420-2	1 COB	41 W	1275 - 1454 lm	A++	6.8 kg	360°	W 30 40	ND DI DA
Ø160 - 500 mm - Cúpula redondeada									
DAISY 1	70421-1	1 COB	41 W	1275 - 1454 lm	A++	5.6 kg	360°	W 30 40	ND DI DA
Ø160 - 480 mm - Cúpula plana									
DAISY 1	70421-2	1 COB	41 W	1275 - 1454 lm	A++	5.6 kg	360°	W 30 40	ND DI DA
Ø160 - 1077 mm - Cúpula redondeada									
DAISY 1	70422-1	1 COB	41 W	1275 - 1454 lm	A++	8.2 kg	360°	W 30 40	ND DI DA
Ø160 - 1057 mm - Cúpula plana									
DAISY 1	70422-2	1 COB	41 W	1275 - 1454 lm	A++	8.2 kg	360°	W 30 40	ND DI DA
Ø186 - 830 mm - Cúpula redondeada									
DAISY 2	70423-1	1 COB	41 W	1406 - 1602 lm	A++	8.2 kg	360°	W 30 40	ND DI DA
Ø186 - 796 mm - Cúpula plana									
DAISY 2	70423-2	1 COB	41 W	1406 - 1602 lm	A++	8.2 kg	360°	W 30 40	ND DI DA
Ø186 - 1135 mm - Cúpula redondeada									
DAISY 2	70424-1	1 COB	41 W	1406 - 1602 lm	A++	9.6 kg	360°	W 30 40	ND DI DA
Ø186 - 1101 mm - Cúpula plana									
DAISY 2	70424-2	1 COB	41 W	1406 - 1602 lm	A++	9.6 kg	360°	W 30 40	ND DI DA
Ø186 - 558 mm - Cúpula redondeada									
DAISY 2	70425-1	1 COB	41 W	1406 - 1602 lm	A++	6.9 kg	360°	W 30 40	ND DI DA
Ø186 - 524 mm - Cúpula plana									
DAISY 2	70425-2	1 COB	41 W	1406 - 1602 lm	A++	6.9 kg	360°	W 30 40	ND DI DA

	Perno de anclaje	Núcleo de seguridad (Anti-traffic)	Núcleo de seguridad (Anti-traffic)
	70430	70432	70433
70420-1	•	•	
70420-2	•	•	
70421-1	•		
70421-2	•		
70422-1	•		•
70422-2	•		•

	Perno de anclaje	Núcleo de seguridad (Anti-traffic)	Núcleo de seguridad (Anti-traffic)
	70431	70432	70433
70423-1	•	•	
70423-2	•	•	
70424-1	•		•
70424-2	•		•
70425-1	•		
70425-2	•		

Estilo de cúpula

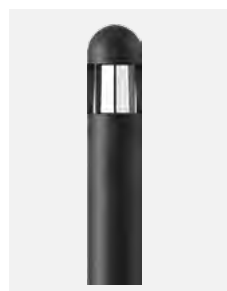

DAISY 1

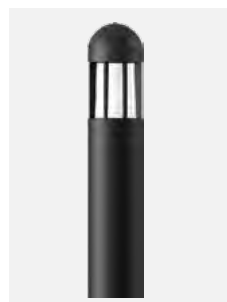

DAISY 2

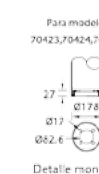
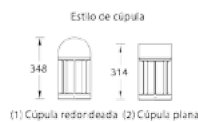
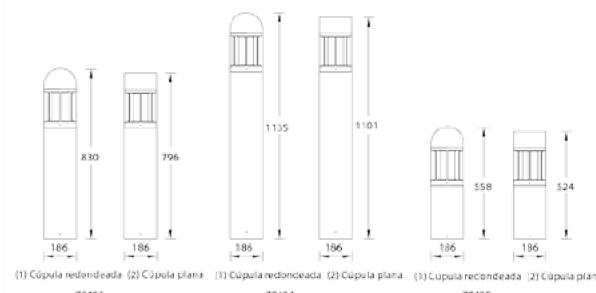
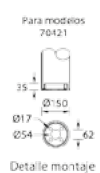
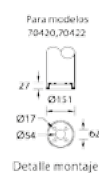
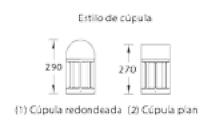
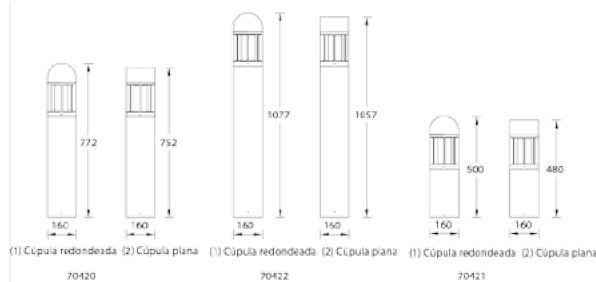



Accesorio de bolardo de iluminación suave con diseño de pilar. Nivel comercial de calidad y rendimiento dentro de una estética doméstica.

ERIN
Bolardos



Código de color de luminaria

- 01 Negro	- 02 Gris Oscuro	- 03 Blanco	- 05 Plata Mate	- 06 Bronce
RAL 9011	RAL 7043	RAL 9003	RAL 9006	RAL 6014



Estructura de luminaria

- Carcasa de aluminio fundido a presión y columna de aluminio extruido pretratado antes del recubrimiento en polvo que garantizan una alta resistencia a la corrosión
- Entrada de cable única
- Un conector IP68 suministrado con 0,2 m de cable exterior de 3x1,0 mm²
- Sujetadores de acero inoxidable en grado 316
- Junta de goma de silicona duradera
- Difusor de policarbonato transparente u opalino, resistente a los impactos y estabilizado a los rayos UV
- Equipo de control integral

Símbolos de funciones

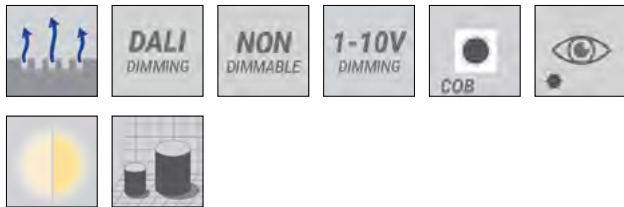

Símbolos de luz

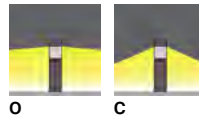

ERIN Bolardos

Guía código producto

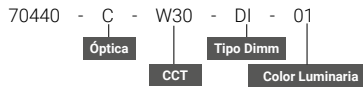

Óptica
C - Difusor transparente
O - Difusor opal

Temperatura del color
W30 - 3000K
W40 - 4000K

Tipo Regulación
ND - No dimmable
DI - Dimmable 1-10V
DA - Dimmable DALI

Color Luminaria
01 - Negro
02 - Gris Oscuro
03 - Blanco
05 - Plata Mate
06 - Bronce

Código	Chip	Potencia	Lumen	EEC	Peso	Óptica		CCT	Electrónica	
						O	C			
Ø102 - 665 mm - Redondo										
ERIN 3	70440	1 COB	15 W	355 - 480 lm	A+	2.5 kg	360°	146°x 119°	W 30 40	ND DI DA
Ø102 - 1065 mm - Redondo										
ERIN 3	70441	1 COB	15 W	355 - 480 lm	A+	3.5 kg	360°	121°x 139°	W 30 40	ND DI DA
102x102 mm - 668 mm - Cuadrado										
ERIN 4	70442	1 COB	15 W	307 - 463 lm	A+	3.1 kg	360°	146°x 119°	W 30 40	ND DI DA
102x102 mm - 1068 mm - Cuadrado										
ERIN 4	70443	1 COB	15 W	307 - 463 lm	A+	4.1 kg	360°	121°x 139°	W 30 40	ND DI DA

	Perno de anclaje	Núcleo de seguridad (Anti-traffic)	Núcleo de seguridad (Anti-traffic)
	70446	70447	70448
70440	•	•	
70441	•		•
70442	•	•	
70443	•		•



ERIN 3

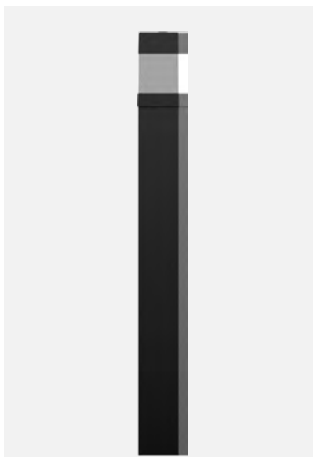
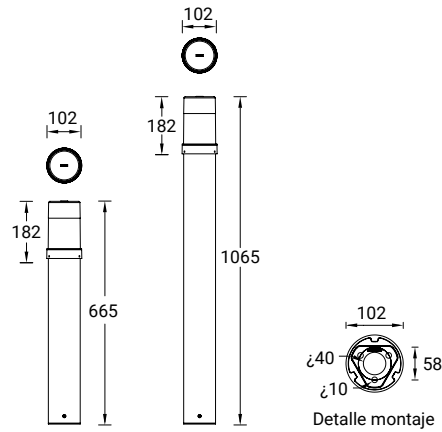

ERIN 4

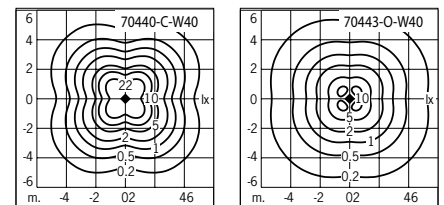
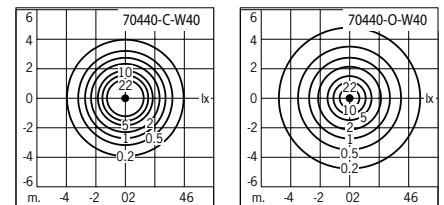
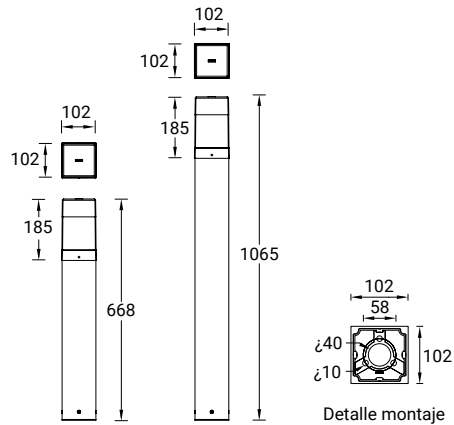

Bolardos VELMA



Gama de bolardo exterior clásica y económica. Forma urbana elegante con acento de luz lateral y tapas superiores opcionales.



Código de color de luminaria

-01 Negro	-02 Gris Oscuro	-03 Blanco	-05 Plata Mate	-06 Bronce
RAL 9011	RAL 7043	RAL 9003	RAL 9006	RAL 6014



Estructura de luminaria

- Carcasa de aluminio fundido a presión y columna de aluminio extruido pretratado antes del recubrimiento en polvo que garantizan una alta resistencia a la corrosión
- Entrada de cable única
- Un conector IP68 suministrado con 0,2 m de cable exterior de 3x1,0 mm²
- Sujetadores de acero inoxidable en grado 316
- Junta de goma de silicona duradera
- Reflector de aluminio anodizado de alta pureza
- Difusor de policarbonato transparente, resistente a los impactos y estabilizado a los rayos UV
- Equipo de control integral

Símbolos de funciones



Símbolos de luz



VELMA Bolardos

Guía código producto

70460 - 1 - W30 - DI - 01

Cúpula Tipo Dimm Color Luminaria
CCT

Estilo cúpula
 1 - Redondeada
 2 - Plana

Temperatura del color
 W30 - 3000K
 W40 - 4000K

Tipo Regulación
 ND - No dimmable
 DI - Dimmable 1-10V
 DA - Dimmable DALI

Color Luminaria
 01 - Negro
 02 - Gris Oscuro
 03 - Blanco
 05 - Plata Mate
 06 - Bronce

Código	Chip	Potencia	Lumen	EEC	Peso	Óptica	CCT	Electrónica
Ø217 - 724 mm - Cúpula redondeada								
VELMA 1	70460-1	1 COB	41 W	983 - 995 lm	A++	8.4 kg	115°x 129°	W 30 40 ND DI DA
Ø217 - 711 mm - Cúpula plana								
VELMA 1	70460-2	1 COB	41 W	983 - 995 lm	A++	8.4 kg	115°x 129°	W 30 40 ND DI DA
Ø217 - 1029 mm - Cúpula redondeada								
VELMA 2	70461-1	1 COB	41 W	983 - 995 lm	A++	11.5 kg	115°x 129°	W 30 40 ND DI DA
Ø217 - 1016 mm - Cúpula plana								
VELMA 2	70461-2	1 COB	41 W	983 - 995 lm	A++	11.5 kg	115°x 129°	W 30 40 ND DI DA
Ø217 - 452 mm - Cúpula redondeada								
VELMA 3	70462-1	1 COB	41 W	983 - 995 lm	A++	6.7 kg	115°x 129°	W 30 40 ND DI DA
Ø217 - 439 mm - Cúpula plana								
VELMA 3	70462-2	1 COB	41 W	983 - 995 lm	A++	6.7 kg	115°x 129°	W 30 40 ND DI DA

					
	70464	70465	70466	70467	70468
70460-1	•	•	•	•	
70460-2	•	•	•	•	
70461-1	•	•	•		•
70461-2	•	•	•		•
70462-1	•	•	•		
70462-2	•	•	•		

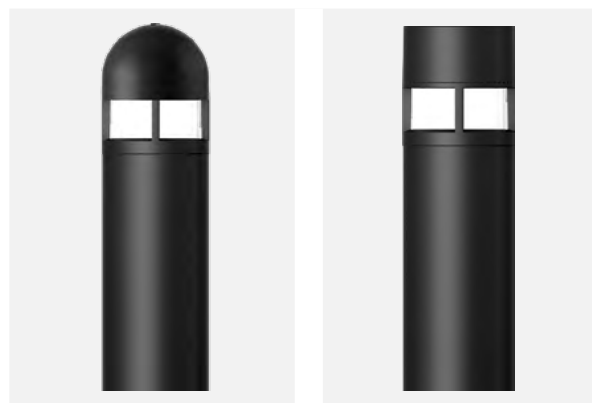

VELMA (Cúpula redondeada)

VELMA (Cúpula plana)

Estilo de cúpula

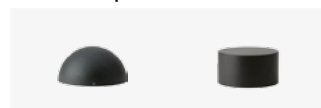

1-Cúpula redondeada 2-Cúpula plana

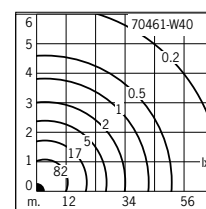
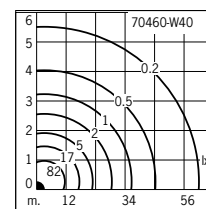
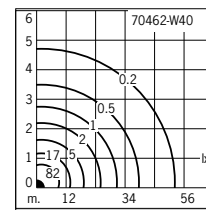
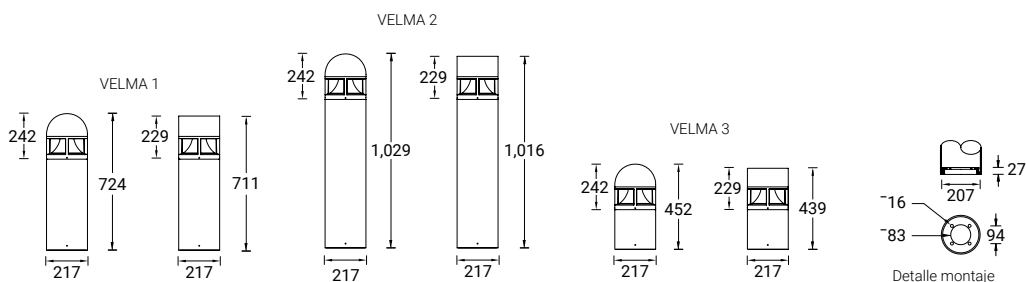



Accesorios para bolardos compactos y apantallados. Escala residencial, proporciona una suave iluminación ascendente y descendente.

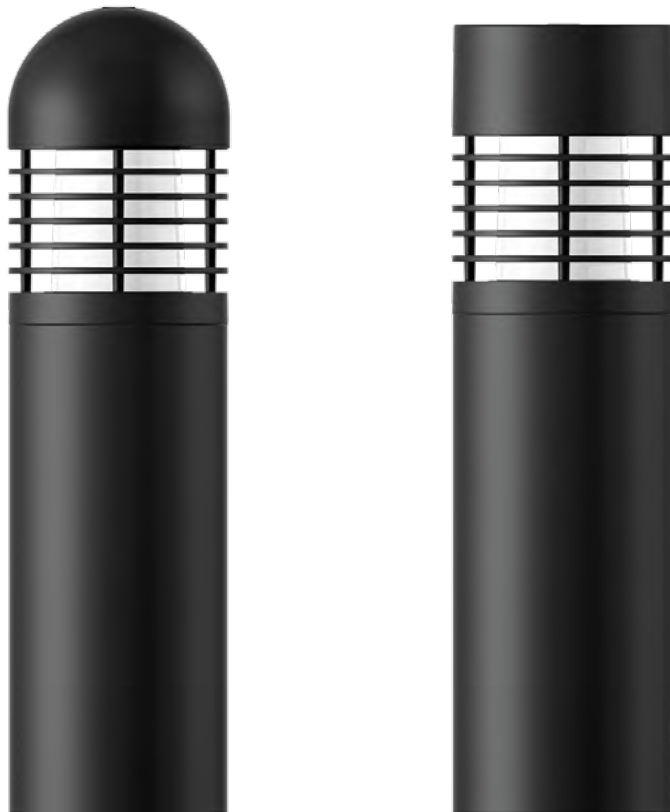

Código de color de luminaria

-01	-02	-03	-05	-06
Negro	Gris Oscuro	Blanco	Plata Mate	Bronce
RAL 9011	RAL 7043	RAL 9003	RAL 9006	RAL 6014



Estructura de luminaria

- Carcasa de aluminio fundido a presión y columna de aluminio extruido pretratado antes del recubrimiento en polvo que garantizan una alta resistencia a la corrosión
- Entrada de cable única
- Un conector IP68 suministrado con 0,5 m de cable exterior de 3x1,0 mm²
- Sujetadores de acero inoxidable en grado 316
- Junta de goma de silicona duradera
- Difusor de cristal opal
- Equipo de control integral

Símbolos de funciones



Símbolos de luz

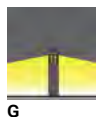

Guía código producto

70480 - 1 - W30 - DI - 01

Cúpula
CCT
Tipo Dimm
Color Luminaria







Estilo cúpula
 1 - Redondeada
 2 - Plana

Temperatura del color
 W30 - 3000K
 W40 - 4000K

Tipo Regulación
 ND - No dimmable
 DI - Dimmable 1-10V
 DA - Dimmable DALI

Color Luminaria
 01 - Negro
 02 - Gris Oscuro
 03 - Blanco
 05 - Plata Mate
 06 - Bronce

Código	Chip	Potencia	Lumen	EEC	Peso	Óptica	CCT	Electrónica	
Ø160 - 756 mm - Cúpula redondeada									
GIA 1	70480-1	1 COB	41 W	733 - 742 lm	A++	7.2 kg	360°	W 30 40	ND DA
Ø160 - 736 mm - Cúpula plana									
GIA 1	70480-2	1 COB	41 W	733 - 742 lm	A++	7.2 kg	360°	W 30 40	ND DA
Ø160 - 1061 mm - Cúpula redondeada									
GIA 1	70481-1	1 COB	41 W	733 - 742 lm	A++	8.6 kg	360°	W 30 40	ND DI DA
Ø160 - 1041 mm - Cúpula plana									
GIA 1	70481-2	1 COB	41 W	733 - 742 lm	A++	8.6 kg	360°	W 30 40	ND DI DA
Ø160 - 484 mm - Cúpula redondeada									
GIA 1	70482-1	1 COB	41 W	733 - 742 lm	A++	6.0 kg	360°	W 30 40	ND DI DA
Ø160 - 464 mm - Cúpula plana									
GIA 1	70482-2	1 COB	41 W	733 - 742 lm	A++	6.0 kg	360°	W 30 40	ND DI DA
Ø186 - 792 mm - Cúpula redondeada									
GIA 2	70483-1	1 COB	41 W	664 - 673 lm	A++	8.8 kg	360°	W 30 40	ND DI DA
Ø186 - 758 mm - Cúpula plana									
GIA 2	70483-2	1 COB	41 W	664 - 673 lm	A++	8.8 kg	360°	W 30 40	ND DI DA
Ø186 - 1097 mm - Cúpula redondeada									
GIA 2	70484-1	1 COB	41 W	664 - 673 lm	A++	10.3 kg	360°	W 30 40	ND DI DA
Ø186 - 1063 mm - Cúpula plana									
GIA 2	70484-2	1 COB	41 W	664 - 673 lm	A++	10.3 kg	360°	W 30 40	ND DI DA
Ø186 - 520 mm - Cúpula redondeada									
GIA 2	70485-1	1 COB	41 W	664 - 673 lm	A++	7.5 kg	360°	W 30 40	ND DI DA
Ø186 - 486 mm - Cúpula plana									
GIA 2	70485-2	1 COB	41 W	664 - 673 lm	A++	7.5 kg	360°	W 30 40	ND DI DA
Ø217 - 776 mm - Cúpula redondeada									
GIA 3	70486-1	1 COB	41 W	385 - 390 lm	A++	10.4 kg	360°	W 30 40	ND DI DA
Ø217 - 763 mm - Cúpula plana									
GIA 3	70486-2	1 COB	41 W	385 - 390 lm	A++	10.4 kg	360°	W 30 40	ND DI DA
Ø217 - 1081 mm - Cúpula redondeada									
GIA 3	70487-1	1 COB	41 W	385 - 390 lm	A++	13.4 kg	360°	W 30 40	ND DI DA
Ø217 - 1068 mm - Cúpula plana									
GIA 3	70487-2	1 COB	41 W	385 - 390 lm	A++	13.4 kg	360°	W 30 40	ND DI DA
Ø217 - 504 mm - Cúpula redondeada									
GIA 3	70488-1	1 COB	41 W	385 - 390 lm	A++	8.7 kg	360°	W 30 40	ND DI DA
Ø217 - 491 mm - Cúpula plana									
GIA 3	70488-2	1 COB	41 W	385 - 390 lm	A++	8.7 kg	360°	W 30 40	ND DI DA

							
	Perno de anclaje	Perno de anclaje	Perno de anclaje	Núcleo de seguridad (Anti-traffic)	Núcleo de seguridad (Anti-traffic)	Núcleo de seguridad (Anti-traffic)	Núcleo de seguridad (Anti-traffic)
	70430	70431	70466	70432	70433	70467	70468
70480-1	•			•			
70480-2	•			•			
70481-1	•				•		
70481-2	•				•		
70483-1		•		•			
70483-2		•		•			
70484-1		•			•		
70484-2		•			•		
70486-1			•			•	
70486-2			•			•	
70487-1			•				•
70487-2			•				•
70482-1	•						
70482-2	•						
70485-1		•					
70485-2		•					
70488-1			•				
70488-2			•				

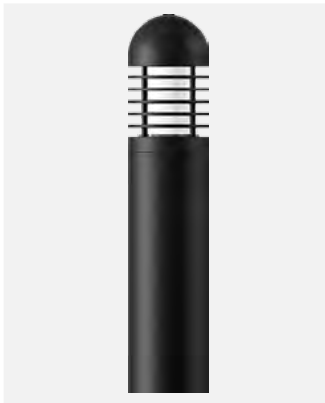

GIA (Cúpula redondeada)

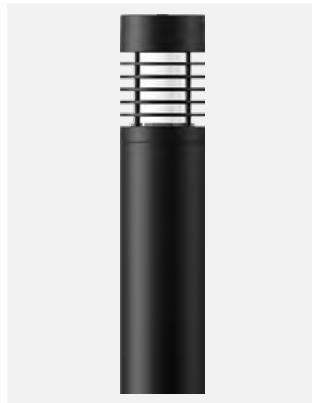

GIA (Cúpula plana)

Estilo de cúpula

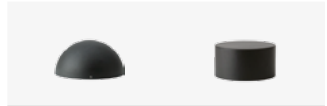

1-Cúpula redondeada 2-Cúpula plana

GIA 1

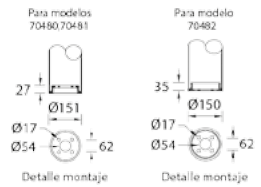
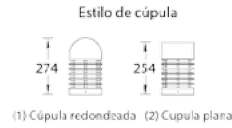
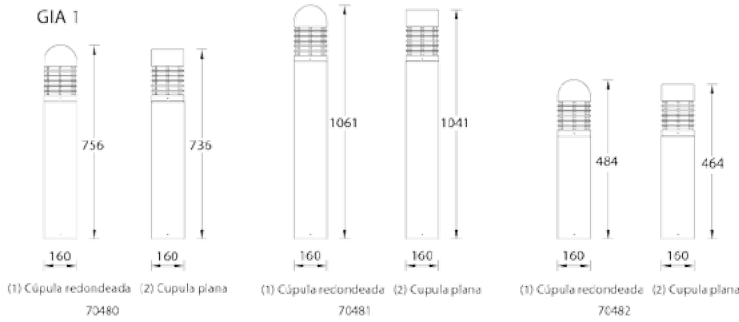

GIA 2

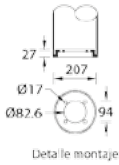
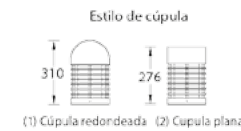
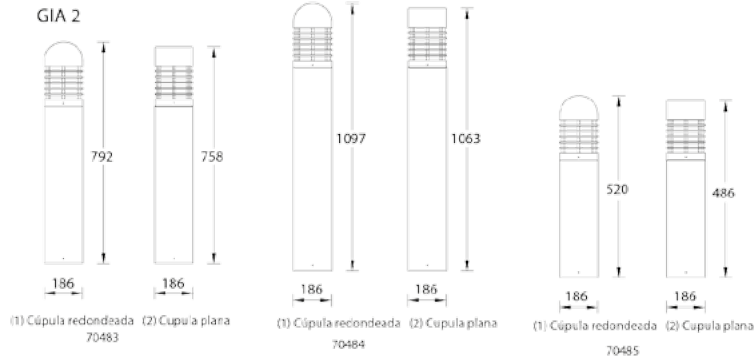

GIA 3

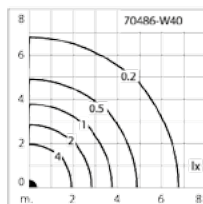
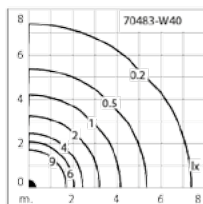
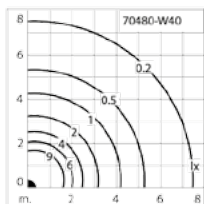
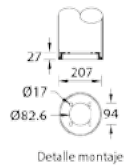
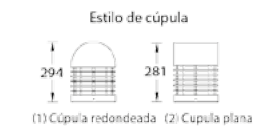
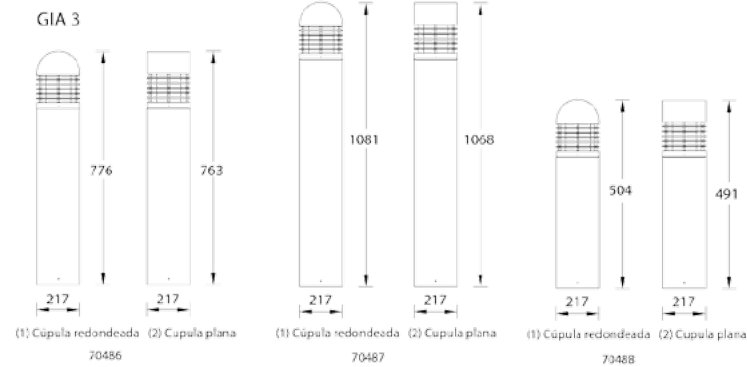





NORA

Bolardos

Robusta vía de bolardo urbano y luminaria de escalera.
Diseñado para ofrecer niveles de tarea de borde a borde a
partir de un factor de forma clásico.



Código de color de luminaria

				
-01 Negro	-02 Gris Oscuro	-03 Blanco	-05 Plata Mate	-06 Bronce
RAL 9011	RAL 7043	RAL 9003	RAL 9006	RAL 6014



Estructura de Luminaria

- Carcasa de aluminio fundido a presión y columna de chapa de aluminio formada pretratada antes del recubrimiento en polvo que garantiza una alta resistencia a la corrosión
- Entrada de cable única
- Sujetadores de acero inoxidable en grado 316
- Un conector IP68 suministrado con 0,5 m de cable exterior de 3x1,0 mm²
- Junta de goma de silicona duradera
- Lente de extensión lineal endurecida
- Equipo de control integral

Símbolos de funciones

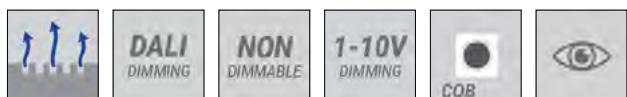

Símbolos de luz



G

NORA Bolardos

<p>Guía código producto</p> <p>70082 - W30 - ND - 01</p> <p>CCT Tipo Dimm Color Luminaria</p>	<p>Temperatura del Color</p> <p>W30 - 3000K W40 - 4000K</p>	<p>Tipo Regulación</p> <p>ND - No dimmable DI - Dimmable 1-10V DA - Dimmable DALI</p>	<p>Color Luminaria</p> <p>01 - Negro 02 - Gris Oscuro 03 - Blanco 05 - Plata Mate 06 - Bronce</p>
---	---	---	---

Código	Chip	Potencia	Lumen	EEC	Peso	Óptica	CCT	Electrónica	
353x160 mm - 800 mm						G			
NORA 2	70082	3 COB	23 W	713 - 769 lm	A+	9.3 kg	110°x 61°	W 30 40	ND DI DA



Perno de ancla

70083

70082



NORA 2

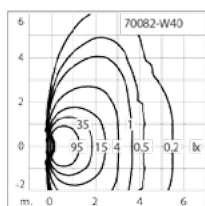
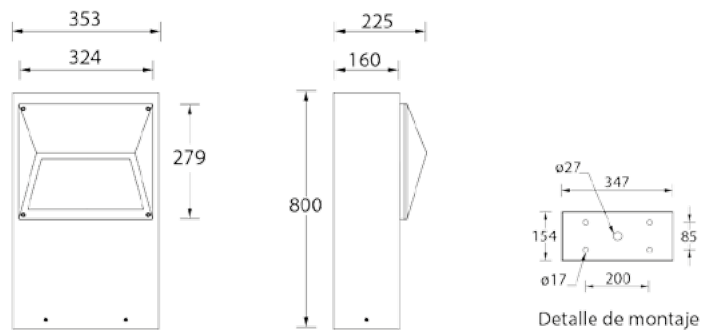



Bolardos VELVET



Gama de bolardos indirectos. Familia de bolardos idóneos y suaves con maravillosas opciones de iluminación controlada suave.



Código de color de luminaria

				
-01 Negro	-02 Gris Oscuro	-03 Blanco	-05 Plata Mate	-06 Bronce
RAL 9011	RAL 7043	RAL 9003	RAL 9006	RAL 6014



Estructura de luminaria

- Carcasa de aluminio fundido a presión y columna de aluminio extruido pretratado antes del recubrimiento en polvo que garantizan una alta resistencia a la corrosión
- Entrada de cable única
- Sujetadores de acero inoxidable en grado 316
- Un conector IP68 suministrado con 0,5 m de cable exterior de 3x1,0 mm²
- Junta de goma de silicona duradera
- Reflector de aluminio anodizado de alta pureza
- Lente de policarbonato transparente, resistente a los impactos y estabilizada a los rayos UV
- Equipo de control integral

Símbolos de funciones

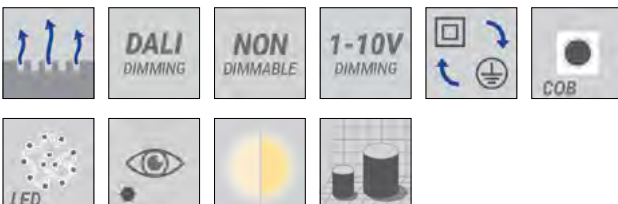

Símbolos de luz

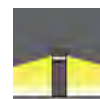

G

VELVET Bolardos

Guía código producto

70500 - W30 - DI - 01

CCT Tipo Dimm Color Luminaria

Temperatura del color
W30 - 3000K
W40 - 4000K

Tipo Regulación
ND - No dimmable
DI - Dimmable 1-10V
DA - Dimmable DALI

Color Luminaria
01 - Negro
02 - Gris Oscuro
03 - Blanco
05 - Plata Mate
06 - Bronce

Código	Chip	Potencia	Lumen	EEC	Peso	Óptica	CCT	Electrónica
Ø186 - 600 mm - Redondo								
VELVET 1	70500	12 LED	27 W	1188 lm	A+	6.1 kg	360°	W 30 40 ND DI DA
Ø186 - 1000 mm - Redondo								
VELVET 1	70501	12 LED	27 W	1188 lm	A+	7.7 kg	360°	W 30 40 ND DI DA
186x186 mm - 600 mm - Cuadrado								
VELVET 2	70502	12 LED	27 W	1050 lm	A+	7.3 kg	360°	W 30 40 ND DI DA
186x186 mm - 1000 mm - Cuadrado								
VELVET 2	70503	12 LED	27 W	1050 lm	A+	9.4 kg	360°	W 30 40 ND DI DA
Ø102 - 600 mm - Redondo								
VELVET 3	70504	1 COB	14 W	447 lm	A+	2.7 kg	360°	W 30 40 ND DI DA
Ø102 - 1000 mm - Redondo								
VELVET 3	70505	1 COB	14 W	447 lm	A+	4.1 kg	360°	W 30 40 ND DI DA
102x102 mm - 600 mm - Cuadrado								
VELVET 4	70506	1 COB	14 W	346 lm	A+	3.2 kg	360°	W 30 40 ND DI DA
102x102 mm - 1000 mm - Cuadrado								
VELVET 4	70507	1 COB	14 W	346 lm	A+	4.7 kg	360°	W 30 40 ND DI DA

	Sensor localización 1 cara	Sensor localización 2 caras	Perno de anclaje	Perno de anclaje	Light shield 180°	Light shield 90°
	70464	70465	70431	70446	70510	70511
70504				•		
70505				•		
70506				•		
70507				•		
70500	•	•	•		•	•
70501	•	•	•		•	•
70502	•	•	•		•	•
70503	•	•	•		•	•

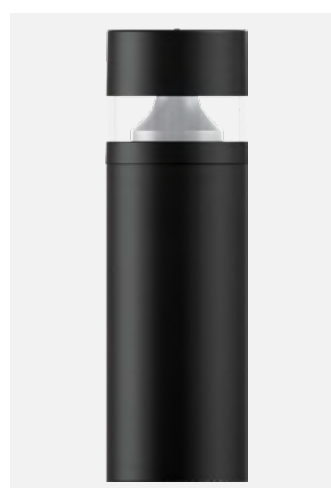

VELVET 1

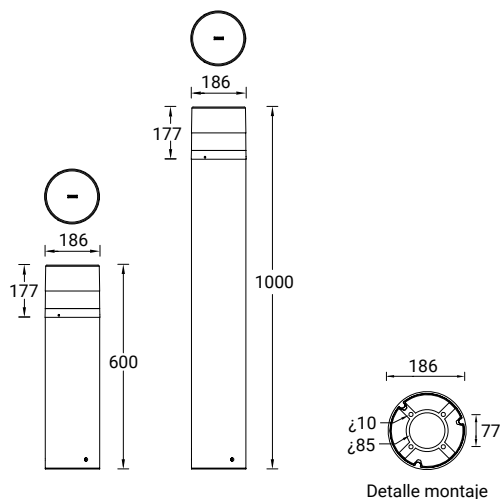

VELVET Bolardos

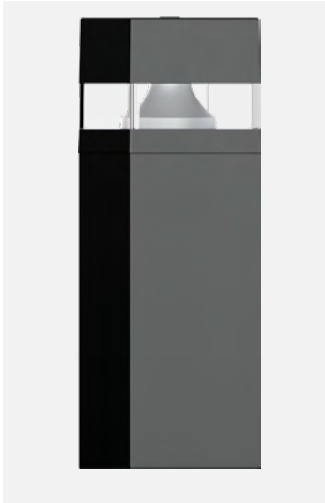

VELVET 2

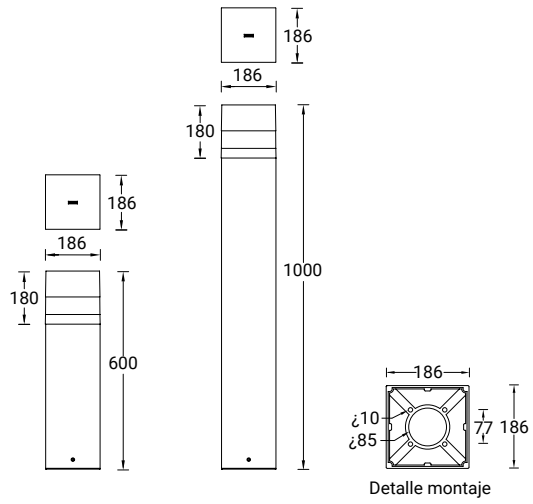

VELVET 3

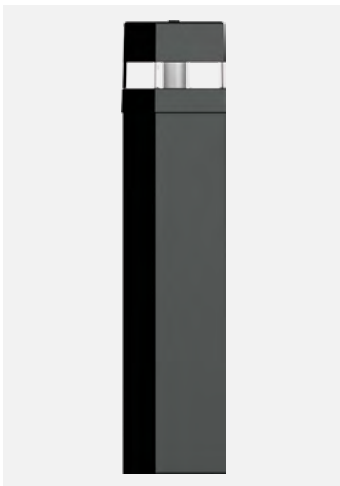
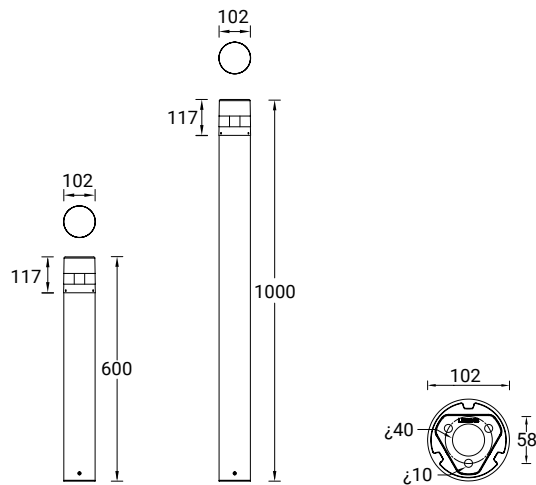

VELVET 4

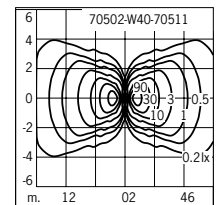
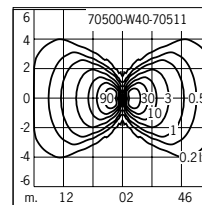
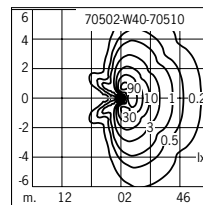
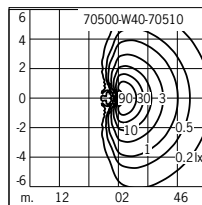
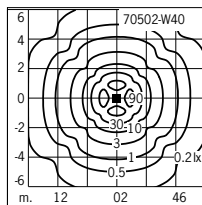
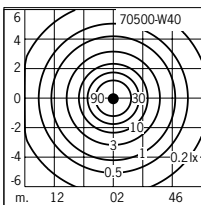
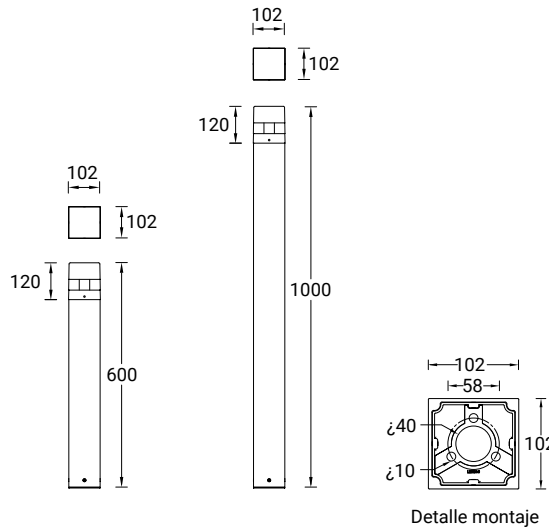

Bolardos JESSA



Pilares de jardín en miniatura. Accesorios de mini pilares de pastoreo a escala doméstica con material y rendimiento de calidad comercial.



Código de color de luminaria

-01 Negro	-02 Gris Oscuro	-03 Blanco	-05 Plata Mate	-06 Bronce
RAL 9011	RAL 7043	RAL 9003	RAL 9006	RAL 6014



Estructura de luminaria

- Carcasa de aluminio fundido a presión y columna de aluminio extruido pretratado antes del recubrimiento en polvo que garantizan una alta resistencia a la corrosión
- Entrada de cable única
- Sujetadores de acero inoxidable en grado 316
- Junta de goma de silicona duradera
- Difusor de vidrio templado transparente
- Equipo de control integral

Símbolos de funciones



Símbolos de luz

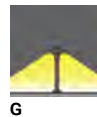

JESSA Bolardos

Guía código producto

70520 - W30 - DI - 01
 CCT Tipo Dimm Color Luminaria

Temperatura del color
 W30 - 3000K
 W40 - 4000K

Tipo Regulación
 ND - No dimmable
 DI - Dimmable 1-10V
 DA - Dimmable DALI

Color Luminaria
 01 - Negro
 02 - Gris Oscuro
 03 - Blanco
 05 - Plata Mate
 06 - Bronce

Código	Chip	Potencia	Lumen	EEC	Peso	Óptica	CCT	Electrónica	
						G			
571 mm - Cúpula plana									
JESSA 1	70520	1 COB	14 W	505 lm	A+	3.5 kg	130°x 130°	W 30 40 ND DI DA	
571 mm - Cúpula redondeada									
JESSA 2	70521	1 COB	14 W	618 lm	A+	4.0 kg	116°x 112°	W 30 40 ND DI DA	



JESSA 1



JESSA 2

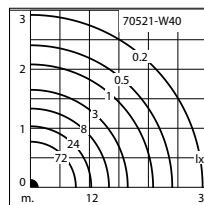
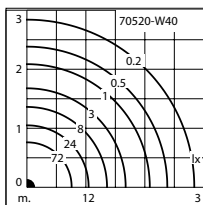
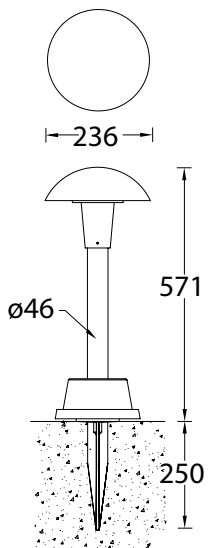
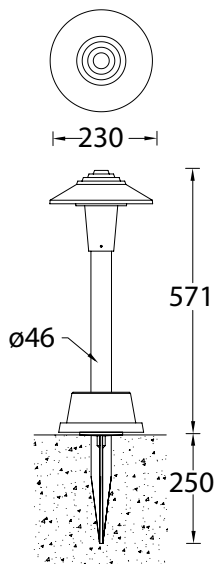



MARGOT

Bolardos

Diseño puro, bonitos bolardos, que proporcionan una iluminación uniforme sin deslumbramiento. Perfección técnica que ofrece eficiencias innovadoras y proporciones de espacio a la altura del proyecto insuperables.

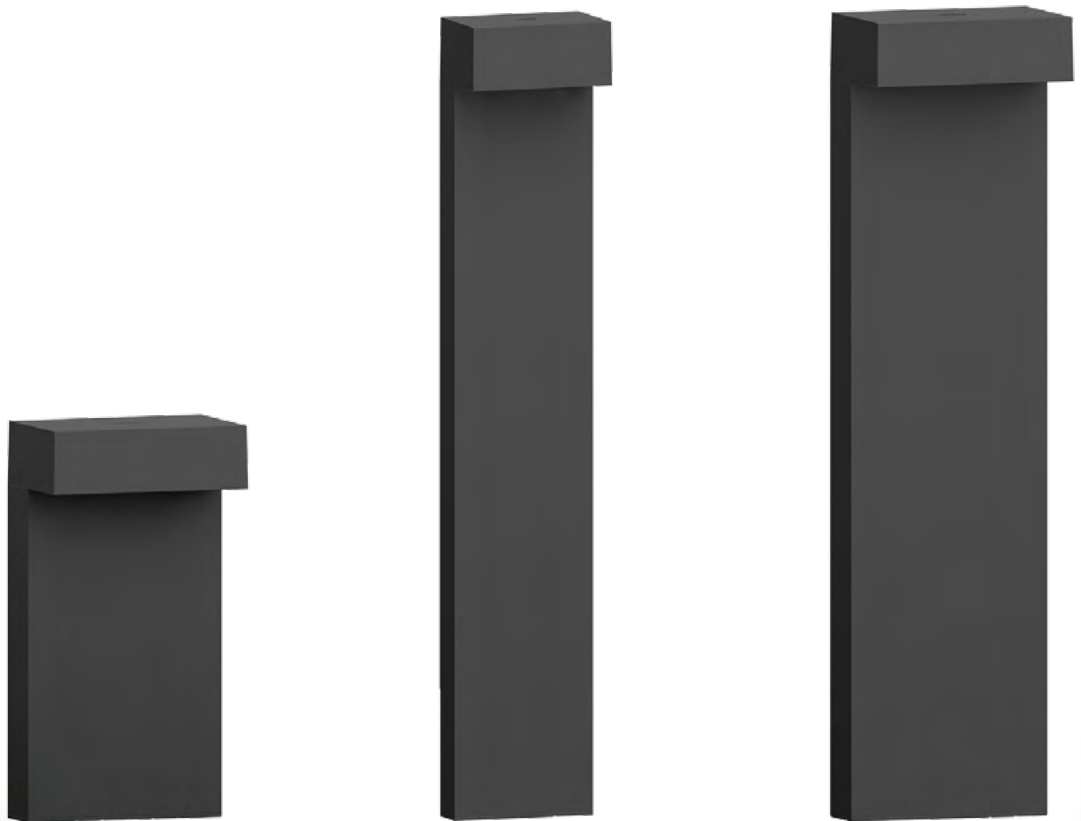

Código de color de luminaria

- 01	- 02	- 03	- 05	- 06
Negro	Gris Oscuro	Blanco	Plata Mate	Bronce
RAL 9011	RAL 7043	RAL 9003	RAL 9006	RAL 6014



Estructura de luminaria

- Carcasa, marco y columna de aluminio extruido pretratados antes del recubrimiento en polvo, lo que garantiza una alta resistencia a la corrosión.
- Entrada de cable única
- Un conector IP68 suministrado con 0,2 m de cable exterior de 3x1,0 mm²
- Sujetadores de acero inoxidable en grado 316
- Junta de goma de silicona duradera
- Vidrio transparente templado
- Lente de PMMA de alta eficiencia
- Equipo de control integral

Símbolos de funciones

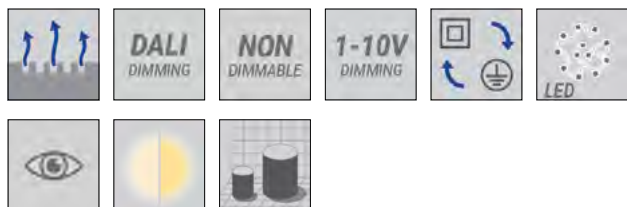

Símbolos de luz



MARGOT Bolardos

Guía código producto

70530 - M - W30 - DI - 01

Óptica CCT Tipo Dimm Color Luminaria

Temperatura del color
 W30 - 3000K
 W40 - 4000K

Tipo Regulación
 ND - No dimmable
 DI - Dimmable 1-10V
 DA - Dimmable DALI

Color Luminaria
 01 - Negro
 02 - Gris Oscuro
 03 - Blanco
 05 - Plata Mate
 06 - Bronce

Código	Chip	Potencia	Lumen	EEC	Peso	Óptica							CCT	Electrónica	
						M	W	EW	T2	T3	T4	ME			
102x50 mm - 500 mm															
MARGOT 1	70530	4 LED	7.6 W	855 lm	A+	3.0 kg	30°	56°	99°x102°	129°x49°	112°x80°	89°x60°	122°x50°	W 30 40	ND
102x50 mm - 1000 mm															
MARGOT 1	70531	4 LED	7.6 W	855 lm	A+	3.0 kg	30°	56°	99°x102°	129°x49°	112°x80°	89°x60°	122°x50°	W 30 40	ND
200x80 mm - 500 mm															
MARGOT 2	70532	8 LED	13.9 W	1660 lm	A+	5.7 kg	30°	56°	110°x103°	139°x55°	123°x85°	105°x69°	139°x60°	W 30 40	ND DI DA
200x80 mm - 1000 mm															
MARGOT 2	70533	8 LED	13.9 W	1660 lm	A+	8.7 kg	30°	56°	110°x103°	139°x55°	123°x85°	105°x69°	139°x60°	W 30 40	ND DI DA
260x75 mm - 500 mm															
MARGOT 3	70534	12 LED	19.7 W	2422 lm	A+	7.0 kg	30°	56°	109°x102°	137°x58°	124°x86°	108°x66°	140°x62°	W 30 40	ND DI DA
260x75 mm - 1000 mm															
MARGOT 3	70535	12 LED	19.7 W	2422 lm	A+	10.4 kg	30°	56°	109°x102°	137°x58°	124°x86°	108°x66°	140°x62°	W 30 40	ND DI DA

	Perno de anclaje 70537	Perno de anclaje 70538	Perno de anclaje 70539
70530			•
70531			•
70532	•		
70533	•		
70534		•	
70535		•	



MARGOT 1

MARGOT 2

MARGOT 3

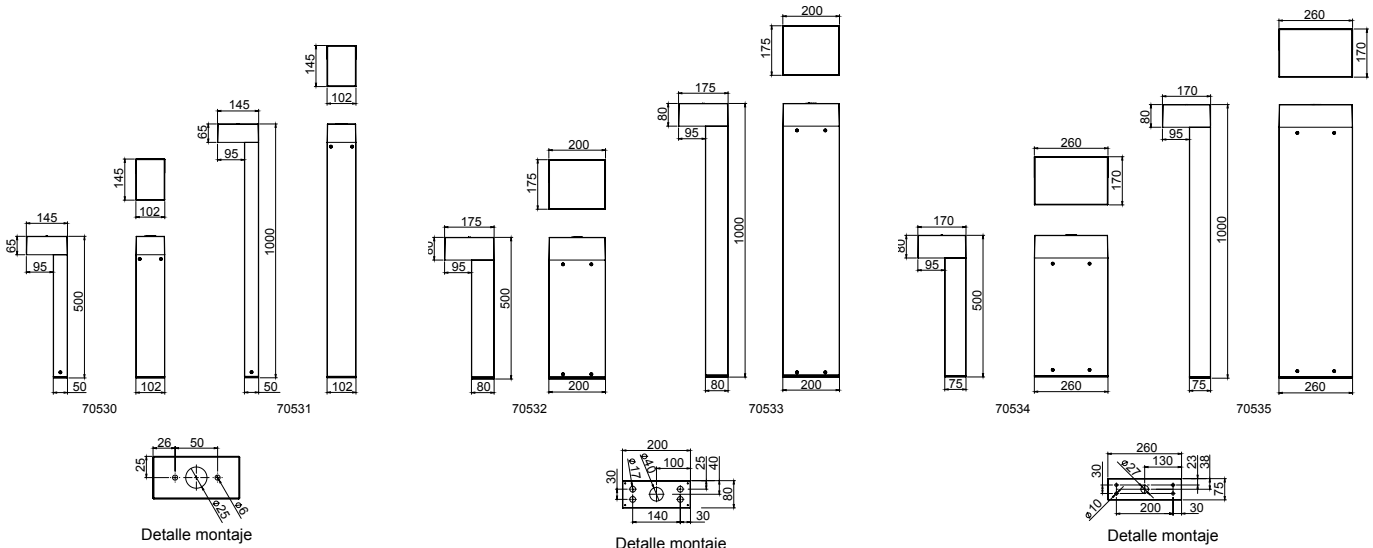



Bolardo redondo recto y limpio. Líneas suaves complementadas con un suave efecto de iluminación del difusor vertical opalino.



Código de color de luminaria

-01 Negro	-02 Gris Oscuro	-03 Blanco	-05 Plata Mate	-06 Bronce
RAL 9011	RAL 7043	RAL 9003	RAL 9006	RAL 6014

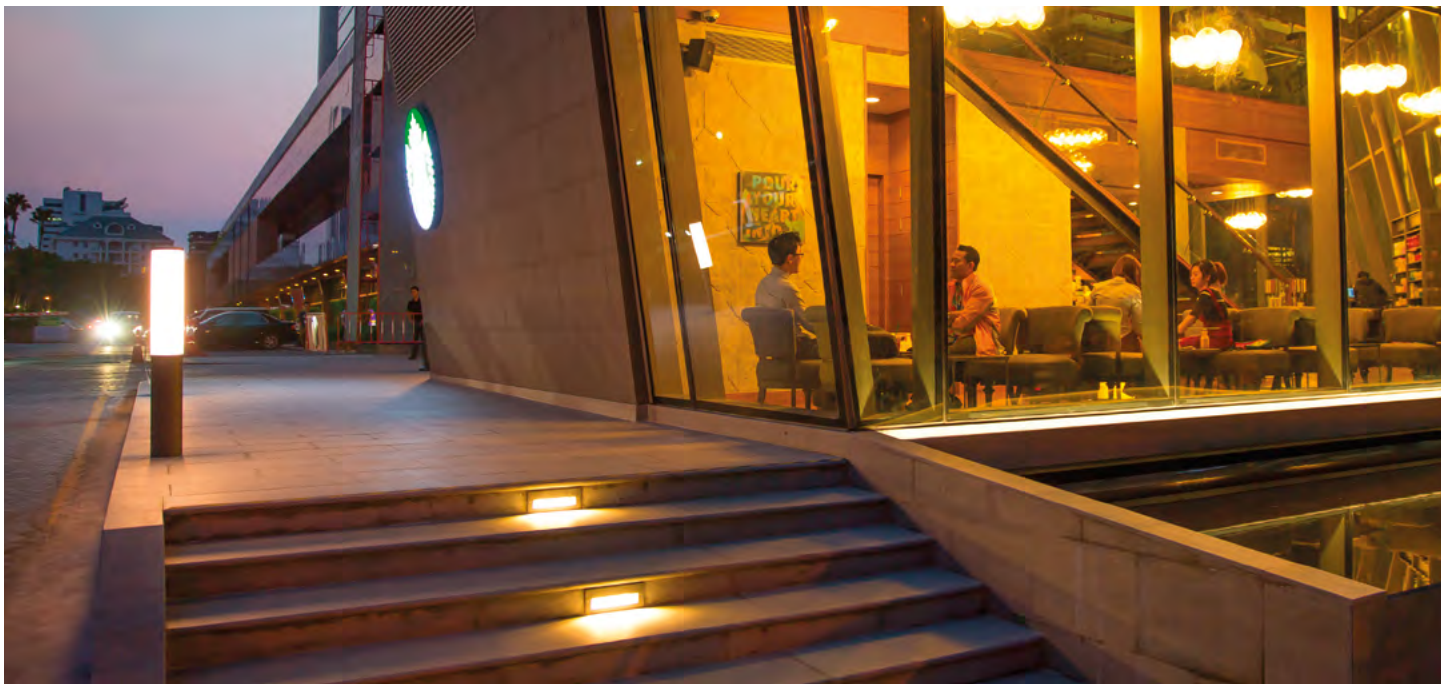

Estructura de luminaria

- Carcasa de aluminio fundido a presión y columna de aluminio extruido pretratado antes del recubrimiento en polvo que garantizan una alta resistencia a la corrosión
- Entrada de cable única
- Un conector IP68 suministrado con 0,2 m de cable exterior de 3x1,0 mm²
- Sujetadores de acero inoxidable en grado 316
- Junta de goma de silicona duradera
- Difusor de policarbonato estabilizado a los rayos UV resistente a los impactos opal
- Equipo de control integral

Símbolos de funciones



Símbolos de luz

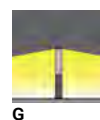

LIAM Bolardos

<p>Guía código producto</p> <p>70550 - W30 - DI - 01</p> <p>CCT Tipo Dimm Color Luminaria</p>	<p>Temperatura del color</p> <p>W30 - 3000K W40 - 4000K</p>	<p>Tipo Regulación</p> <p>ND - No dimmable DI - Dimmable 1-10V DA - Dimmable DALI</p>	<p>Color Luminaria</p> <p>01 - Negro 02 - Gris Oscuro 03 - Blanco 05 - Plata Mate 06 - Bronce</p>
---	---	---	---

Código	Chip	Potencia	Lumen	EEC	Peso	Óptica	CCT	Electrónica	
Round - Ø160 - 1229 mm							G		
LIAM 1	70550	3 x 32 LED	33 W	1561 - 1644 lm	A+	7.9 kg	360°	W 30 40	ND DI DA

Sensor localización 1 cara	Sensor localización 2 caras	Perno de anclaje
70464	70465	70430
70550	.	.



LIAM 1

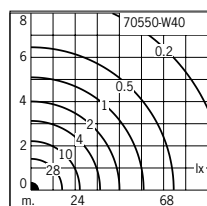
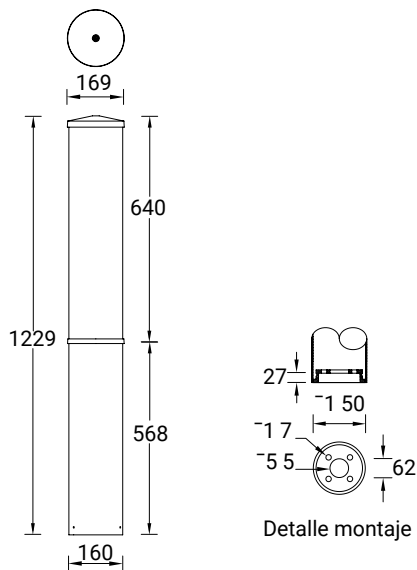



MILLO

Bolardos

familia de bolardos lisos, tranquilos y seguros. Unas opciones de bolardos agradables y cómodas con distribuciones suaves y muchas opciones para adaptarse a las necesidades del proyecto.



Código de color de luminaria

- 01	- 02	- 03	- 05	- 06
Negro	Gris Oscuro	Blanco	Plata Mate	Bronce
RAL 9011	RAL 7043	RAL 9003	RAL 9006	RAL 6014



Estructura de luminaria

- Carcasa de aluminio fundido a presión y columna de aluminio extruido pretratado antes del recubrimiento en polvo que garantizan una alta resistencia a la corrosión
- Entrada de cable única
- Un conector IP68 suministrado con 0,2 m de cable exterior de 3x1,0 mm²
- Sujetadores de acero inoxidable en grado 316
- Junta de goma de silicona duradera
- Reflector de aluminio con acabado arenado
- Difusor de policarbonato transparente, resistente a los impactos y estabilizado a los rayos UV
- Equipo de control integral

Símbolos de funciones



Símbolos de luz

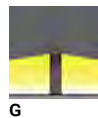

MILO Bolardos

Guía código producto

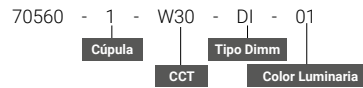

Estilo cúpula
1 - Redondeada
2 - Plana

Temperatura del color
W30 - 3000K
W40 - 4000K

Tipo Regulación
ND - No dimmable
DI - Dimmable 1-10V
DA - Dimmable DALI

Color Luminaria
01 - Negro
02 - Gris Oscuro
03 - Blanco
05 - Plata Mate
06 - Bronce

Código	Chip	Potencia	Lumen	EEC	Peso	Óptica	CCT	Electrónica	
						G			
Ø160 - 1053 mm - Cúpula plana									
MILO 1	70561-2	1 COB	41 W	974 lm	A++	8.2 kg	360°	W 30 40	ND DI DA
Ø160 - 1076 mm - Cúpula redondeada									
MILO 1	70561-1	1 COB	41 W	974 lm	A++	8.2 kg	360°	W 30 40	ND DI DA
Ø160 - 480 mm - Cúpula plana									
MILO 1	70562-2	1 COB	41 W	974 lm	A++	5.9 kg	360°	W 30 40	ND DI DA
Ø160 - 500 mm - Cúpula redondeada									
MILO 1	70562-1	1 COB	41 W	974 lm	A++	5.9 kg	360°	W 30 40	ND DI DA
Ø160 - 748 mm - Cúpula plana									
MILO 1	70560-2	1 COB	41 W	974 lm	A++	7.0 kg	360°	W 30 40	ND DI DA
Ø160 - 771 mm - Cúpula redondeada									
MILO 1	70560-1	1 COB	41 W	974 lm	A++	7.0 kg	360°	W 30 40	ND DI DA
Ø186 - 1053 mm - Cúpula plana									
MILO 2	70564-2	1 COB	41 W	765 lm	A++	8.4 kg	360°	W 30 40	ND DI DA
Ø186 - 1090 mm - Cúpula redondeada									
MILO 2	70564-1	1 COB	41 W	765 lm	A++	8.4 kg	360°	W 30 40	ND DI DA
Ø186 - 478 mm - Cúpula plana									
MILO 2	70565-2	1 COB	41 W	765 lm	A++	5.4 kg	360°	W 30 40	ND DI DA
Ø186 - 513 mm - Cúpula redondeada									
MILO 2	70565-1	1 COB	41 W	765 lm	A++	5.4 kg	360°	W 30 40	ND DI DA
Ø186 - 748 mm - Cúpula plana									
MILO 2	70563-2	1 COB	41 W	765 lm	A++	8.2 kg	360°	W 30 40	ND DI DA
Ø186 - 785 mm - Cúpula redondeada									
MILO 2	70563-1	1 COB	41 W	765 lm	A++	8.2 kg	360°	W 30 40	ND DI DA



Perno de anclaje

70430



Perno de anclaje

70431

70560-1	•	
70560-2	•	
70561-1	•	
70561-2	•	
70562-1	•	
70562-2	•	
70563-1		•
70563-2		•
70564-1		•
70564-2		•
70565-1		•
70565-2		•

MILO Bolardos

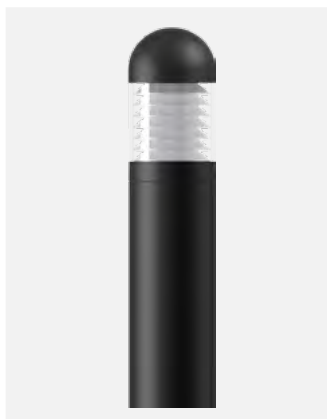

MILO (Cúpula redondeada)



MILO (Cúpula plana)

Estilo de cúpula

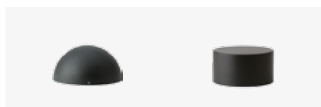

1-Cúpula redondeada 2-Cúpula plana

MILO 1

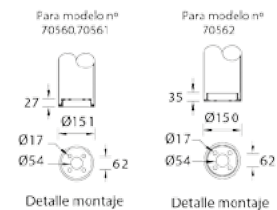
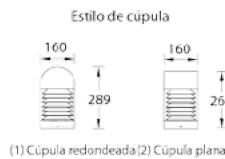
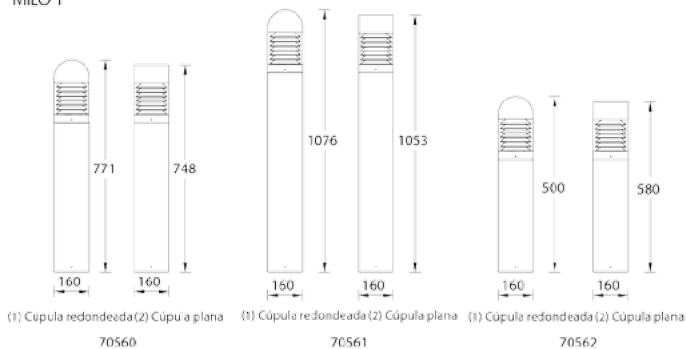

MILO 2

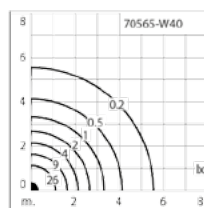
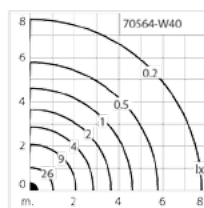
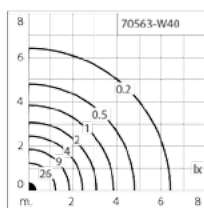
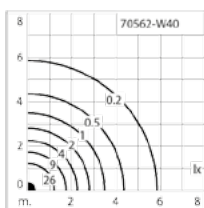
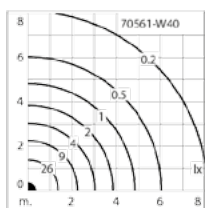
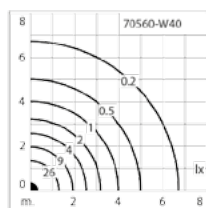
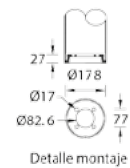
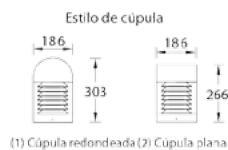
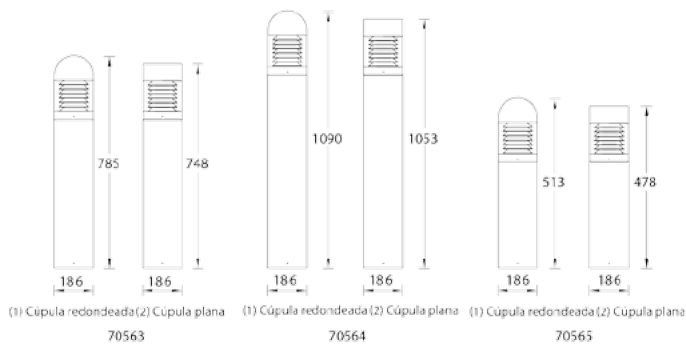



Familia de bolardos casualmente ornamentales. El diseño de cabeza automodulable y blindado ofrece un cómodo efecto de iluminación sin deslumbramiento por la noche.

ORSON

Bolardos

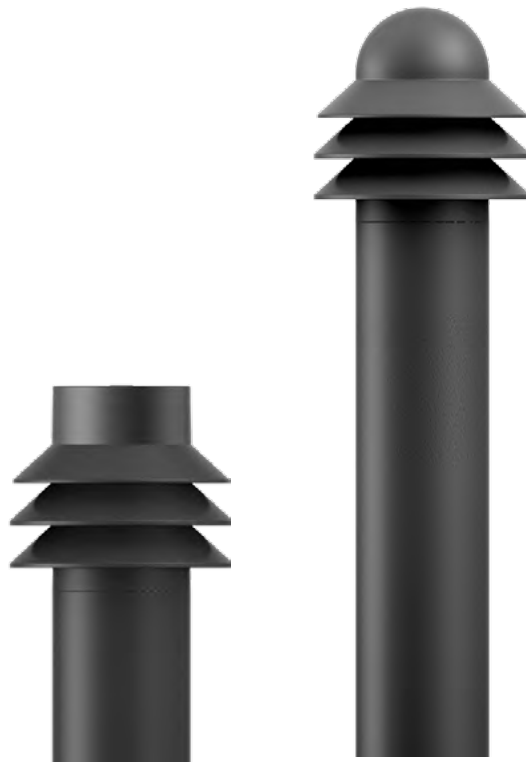

Código de color de luminaria

- 01 Negro	- 02 Gris Oscuro	- 03 Blanco	- 05 Plata Mate	- 06 Bronce
RAL 9011	RAL 7043	RAL 9003	RAL 9006	RAL 6014



Estructura de luminaria

- Carcasa de aluminio fundido a presión y columna de aluminio extruido pretratado antes del recubrimiento en polvo que garantizan una alta resistencia a la corrosión
- Entrada de cable única
- Un conector IP68 suministrado con 0,2 m de cable exterior de 3x1,0 mm²
- Sujetadores de acero inoxidable en grado 316
- Junta de goma de silicona duradera
- Difusor de cristal opal
- Equipo de control integral

Símbolos de funciones

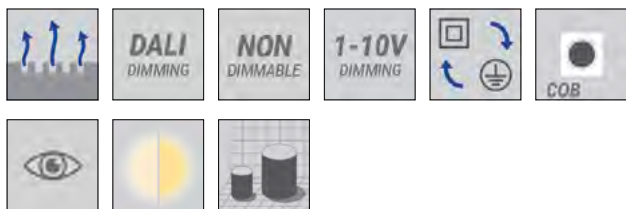

Símbolos de luz



Guía código producto

70570 - 1 - W30 - DI - 01

Cúpula: 1
CCT: W30
Tipo Dimm: DI
Color Luminaria: 01

Estilo cúpula
1 - Redondeada
2 - Plana

Temperatura del color
W30 - 3000K
W40 - 4000K

Tipo Regulación
ND - No dimmable
DI - Dimmable 1-10V
DA - Dimmable DALI

Color Luminaria
01 - Negro
02 - Gris Oscuro
03 - Blanco
05 - Plata Mate
06 - Bronce

Código	Chip	Potencia	Lumen	EEC	Peso	Óptica	CCT	Electrónica	
						G			
Ø160 - 732 mm - Cúpula redondeada									
ORSON 1	70570-1	1 COB	41 W	477 lm	A++	7.6 kg	130°x 133°	W 30 40	ND DI DA
Ø160 - 711 mm - Cúpula plana									
ORSON 1	70570-2	1 COB	41 W	477 lm	A++	7.6 kg	130°x 133°	W 30 40	ND DI DA
Ø160 - 1037 mm - Cúpula redondeada									
ORSON 2	70571-1	1 COB	41 W	477 lm	A++	9.0 kg	130°x 133°	W 30 40	ND DI DA
Ø160 - 1016 mm - Cúpula plana									
ORSON 2	70571-2	1 COB	41 W	477 lm	A++	9.0 kg	130°x 133°	W 30 40	ND DI DA
Ø160 - 460 mm - Cúpula redondeada									
ORSON 3	70572-1	1 COB	41 W	477 lm	A++	6.4 kg	130°x 133°	W 30 40	ND DI DA
Ø160 - 439 mm - Cúpula plana									
ORSON 3	70572-2	1 COB	41 W	477 lm	A++	6.4 kg	130°x 133°	W 30 40	ND DI DA



Perno de anclaje

70430

70570-1	•
70570-2	•
70571-1	•
70571-2	•
70572-1	•
70572-2	•

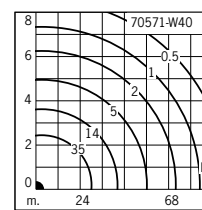
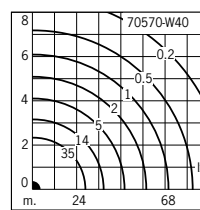
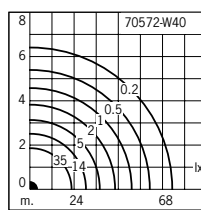

ORSON (Cúpula redondeada)

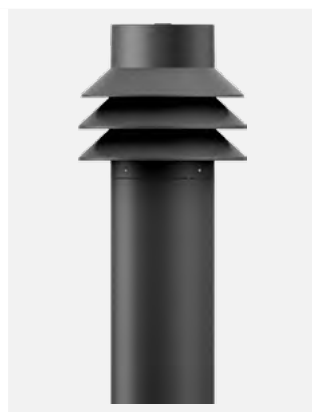

ORSON (Cúpula plana)

Estilo de cúpula

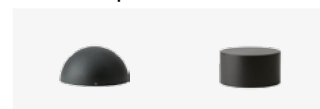

1-Cúpula redondeada 2-Cúpula plana

ORSON 1

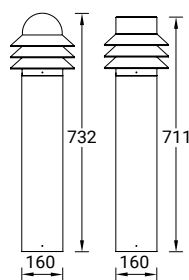

(1) Cúpula redondeada (2) Cúpula plana

ORSON 2

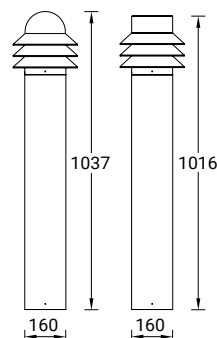

(1) Cúpula redondeada (2) Cúpula plana

ORSON 3

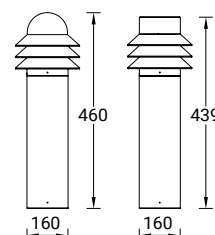

(1) Cúpula redondeada (2) Cúpula plana

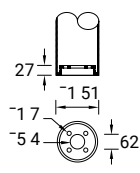

Detalle montaje

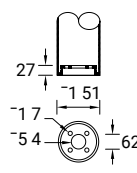

Detalle montaje

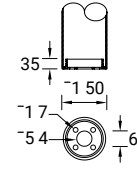

Detalle montaje

Bolardos VALDUS



Bolardo flexible y luminarias orientadoras. Soluciones elegantes, angulares, técnicas y potentes de iluminación profesional.



Código de color de luminaria

-01	-02	-03	-05	-06
Negro	Gris Oscuro	Blanco	Plata Mate	Bronce
RAL 9011	RAL 7043	RAL 9003	RAL 9006	RAL 6014



Estructura de Luminaria

- Carcasa de aluminio fundido a presión y columna de aluminio extruido pretratado antes del recubrimiento en polvo que garantizan una alta resistencia a la corrosión
- Entrada de cable única
- Sujetadores de acero inoxidable en grado 316
- Junta de goma de silicona duradera
- Lente de PMMA de alta eficiencia
- Equipo de control integral

Símbolos de funciones



Símbolos de luz

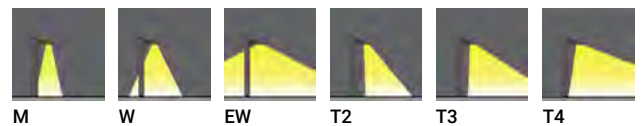

VALDUS Bolardos

Guía código producto

70734 - N - W30 - DI - 01

Óptica

CCT

Tipo Dimm

Color Luminaria

Temperatura del color
W30 - 3000K
W40 - 4000K

Tipo Regulación
ND - No dimmable
DI - Dimmable 1-10V
DA - Dimmable DALI

Color Luminaria
01 - Negro
02 - Gris Oscuro
03 - Blanco
05 - Plata Mate
06 - Bronce

Código	Chip	Potencia	Lumen	EEC	Peso	Óptica				CCT	Electrónica			
						M	W	EW	T2			T3	T4	
Ø102 - 1200 mm - 1 lado														
VALDUS 3	70734	12 LED	20 W	2446 lm	A++	7.5 kg	31°	53°	119°	144°x50°	139°x68°	97°x77°	W 30 40	ND DI DA
	70735	12 LED	28 W	3308 lm	A+	7.5 kg	31°	53°	119°	144°x50°	139°x68°	97°x77°	W 30 40	ND DA
Ø102 - 1200 mm - 2 lados														
VALDUS 4	70736	2 x 12 LED	40 W	4892 lm	A++	11.2 kg	31°	53°	119°	144°x50°	139°x68°	97°x77°	W 30 40	ND DI DA
	70737	2 x 12 LED	56 W	6616 lm	A+	11.2 kg	31°	53°	119°	144°x50°	139°x68°	97°x77°	W 30 40	ND DA

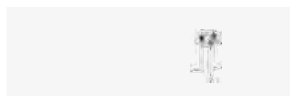

Perno de anclaje

70446

70734	•
70735	•
70736	•
70737	•



VALDUS 3



VALDUS 4

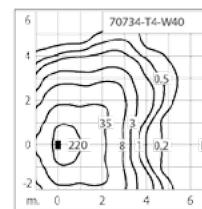
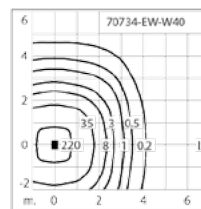
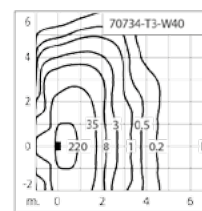
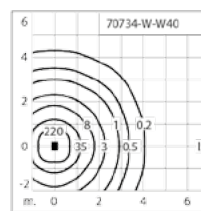
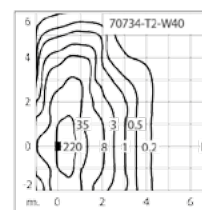
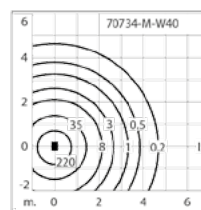
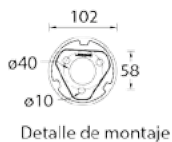
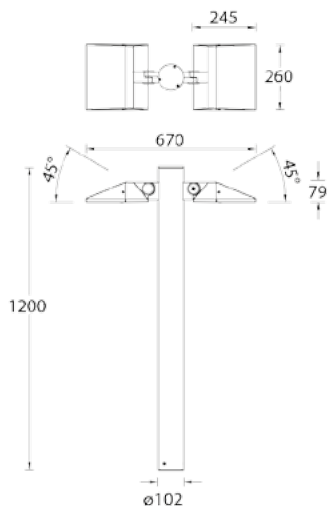
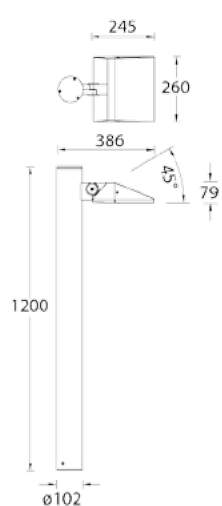



Señalización compacta para la vía pública. Las opciones de orientación de 360 °, 180 ° o de doble cara garantizan la provisión de guía y una huella fuerte y anónima.



Código de color de luminaria

- 01 Negro	- 02 Gris Oscuro	- 03 Blanco	- 05 Plata Mate	- 06 Bronce
RAL 9011	RAL 7043	RAL 9003	RAL 9006	RAL 6014



Estructura de luminaria

- Carcasa de aluminio fundido a presión pretratada antes del recubrimiento en polvo que garantiza una alta resistencia a la corrosión
- Entrada de cable única
- Un conector IP68 suministrado con 0,2 m de cable exterior de 3x1,0 mm²
- Sujetadores de acero inoxidable en grado 316
- Junta de goma de silicona duradera
- Lente de policarbonato transparente, resistente a los impactos y estabilizada a los rayos UV
- Equipo de control integral

Símbolos de funciones



Símbolos de luz



G

UMA Bolardos

<p>Guía código producto</p> <p>70580 - W30 - DI - 01</p> <p style="text-align: center;"> CCT Tipo Dimm Color Luminaria </p>	<p>Temperatura del color W30 - 3000K W40 - 4000K</p>	<p>Tipo Regulación ND - No dimmable DI - Dimmable 1-10V DA - Dimmable DALI</p>	<p>Color Luminaria 01 - Negro 02 - Gris Oscuro 03 - Blanco 05 - Plata Mate 06 - Bronce</p>
---	---	---	---

	Código	Chip	Potencia	Lumen	EEC	Peso	Óptica	CCT	Electrónica
							G		
Pequeño									
UMA 5	70580	1 COB	13 W	704 lm	A+	1.7 kg	360°	W 30 40	ND
	70581	1 COB	13 W	350 lm	A+	1.7 kg	180°	W 30 40	ND
	70582	1 COB	13 W	338 lm	A+	1.7 kg	90° / 90°	W 30 40	ND
Medio									
UMA 6	70583	1 COB	30 W	1605 lm	A+	4 kg	360°	W 30 40	ND DI DA
	70584	1 COB	30 W	821 lm	A+	4 kg	180°	W 30 40	ND DI DA
	70585	1 COB	30 W	804 lm	A+	4 kg	90° / 90°	W 30 40	ND DI DA

	Perno de anclaje 70587	Perno de anclaje 70588
70580	·	
70581	·	
70582	·	
70583		·
70584		·
70585		·



UMA 5

UMA 6

UMA 5

UMA 6

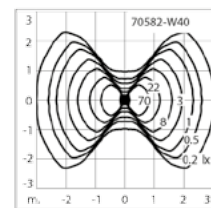
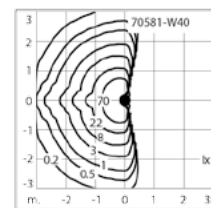
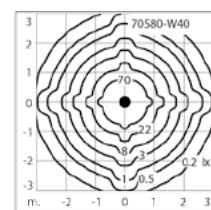
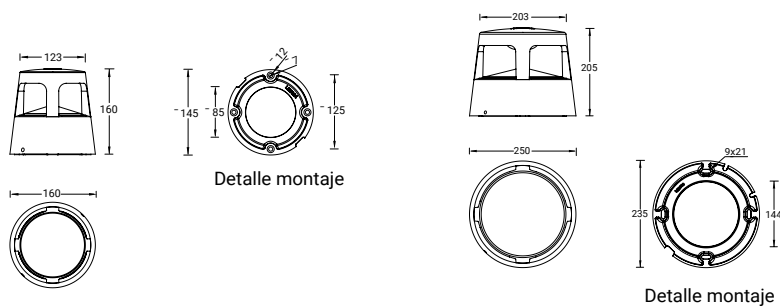

PROYECTORES Y PROYECTORES DE COLUMNA



LENA
página 185



LENA
página 189



LENA
página 192



LENA
página 195



TALA
página 198



TALA
página 201



TALA
página 204



TALA
página 207



TALA
página 210



TALA
página 213



ZANE
página 216



ZANE
página 220



IRISH
página 223



RACHEL
página 226



RACHEL
página 229



XIA
página 232



Familia de focos ajustables de base fija. Identidad popular, disponible en cuatro tamaños de fundición y varias opciones de montaje, blindaje y control.



Código de color de luminaria

- 01 Negro	- 02 Gris Oscuro	- 03 Blanco	- 05 Plata Mate	- 06 Bronce
RAL 9011	RAL 7043	RAL 9003	RAL 9006	RAL 6014



Estructura de luminaria

- Carcasa de aluminio fundido a presión pretratada antes del recubrimiento en polvo que garantiza una alta resistencia a la corrosión
- Entrada de cable única
- A través de cableado bajo pedido
- Sujetadores de acero inoxidable en grado 316
- Junta de goma de silicona duradera
- Lente de PMMA de alta eficiencia
- Vidrio transparente templado
- Equipo de control integral

Símbolos de funciones

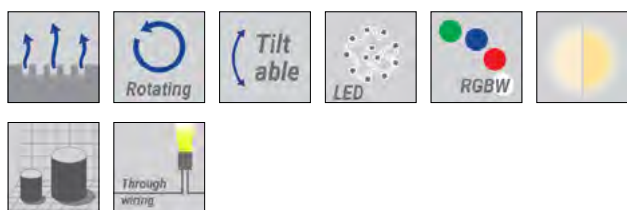

Símbolos de luz

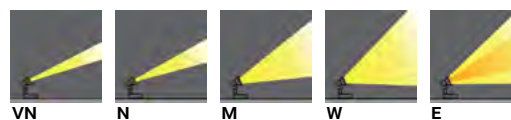

LENA Projectores

Guía código producto

70600 - N - W30 - DI - 01

Óptica
CCT
Tipo Dimm
Color Luminaria

Temperatura del Color
 W30 - 3000K
 W40 - 4000K
 30 - RGBW 3000K
 40 - RGBW 4000K

Tipo Regulación
 ND - No dimmable
 DI - Dimmable 1-10V
 DA - Dimmable DALI

Color Luminaria
 01 - Negro
 02 - Gris Oscuro
 03 - Blanco
 05 - Plata Mate
 06 - Bronce

Código	Chip	Potencia	Lumen	EEC	Peso	Óptica					CCT	Electrónica	
						VN	N	M	W	E			
Pequeño													
LENA 1	70600	7 LED	13 W	1025 lm	A++	2.3 kg	-	19°	27°	40°	-	W 30 40	ND DI DA
	70601	12 LED	20 W	2022 lm	A++	2.5 kg	-	16°	28°	42°	-	W 30 40	ND DI DA
	70602	3 LED	21 W	1798 lm	A++	2.5 kg	8°	-	-	-	-	W 30 40	ND DI DA
Medio													
LENA 3	70603	18 LED	29 W	3081 lm	A+	3.7 kg	-	16°	28°	41°	-	W 30 40	ND DI DA
	70604	24 LED	38 W	4144 lm	A+	3.9 kg	-	15°	26°	45°	-	W 30 40	ND DI DA
	70605	7 LED	33 W	3230 lm	A+	3.9 kg	8°	-	-	-	-	W 30 40	ND DI DA
Medio - RGBW													
LENA 3	70606	7 LED	33 W	1181 lm	A	3.7 kg	-	20°	35°	-	26° x 48°	RGBW 30 40	DMX
Largo													
LENA 5	70607	24 LED	38 W	4172 lm	A+	5.5 kg	-	15°	26°	44°	-	W 30 40	ND DI DA
	70608	36 LED	51 W	6140 lm	A+	5.7 kg	-	16°	26°	41°	-	W 30 40	ND DI DA

	70610	70616	70611	70612	70613	70614	70615
70600	•	•			•		
70601	•	•			•		
70602	•	•			•		
70603		•	•			•	
70604		•	•			•	
70605		•	•			•	
70606		•	•			•	
70607		•		•			•
70608		•		•			•

	79100	79101	79102
70600			
70601			
70602			
70603			
70604			
70605	•	•	•
70606			
70607			
70608			

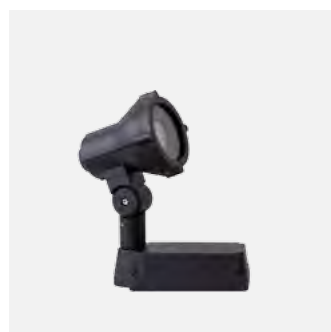

LENA 1

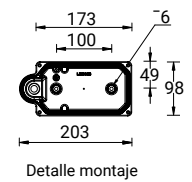
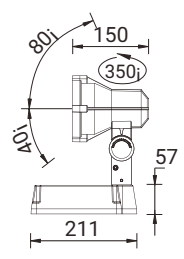
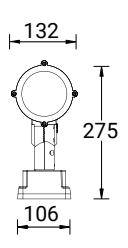

LENA Projectores



LENA 3

LENA 3 RGBW

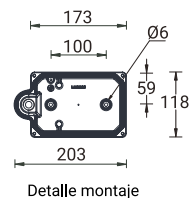
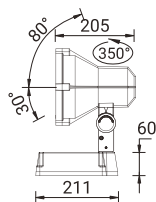
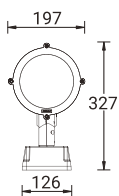

Detalle montaje

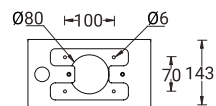
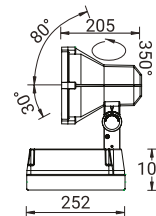
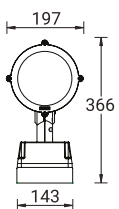

Detalle montaje



LENA 4

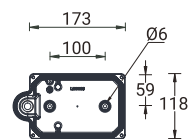
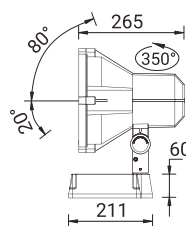
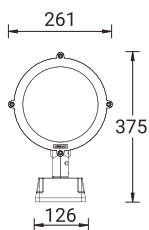

Detalle montaje

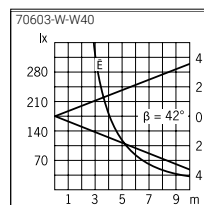
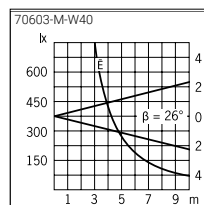
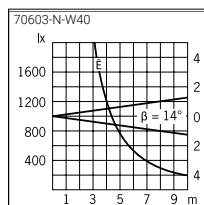
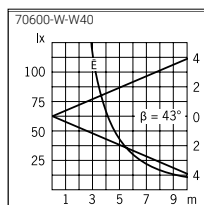
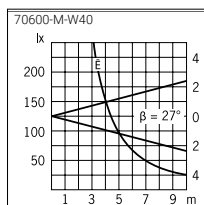
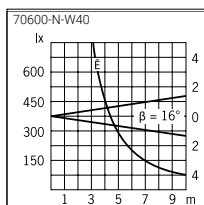
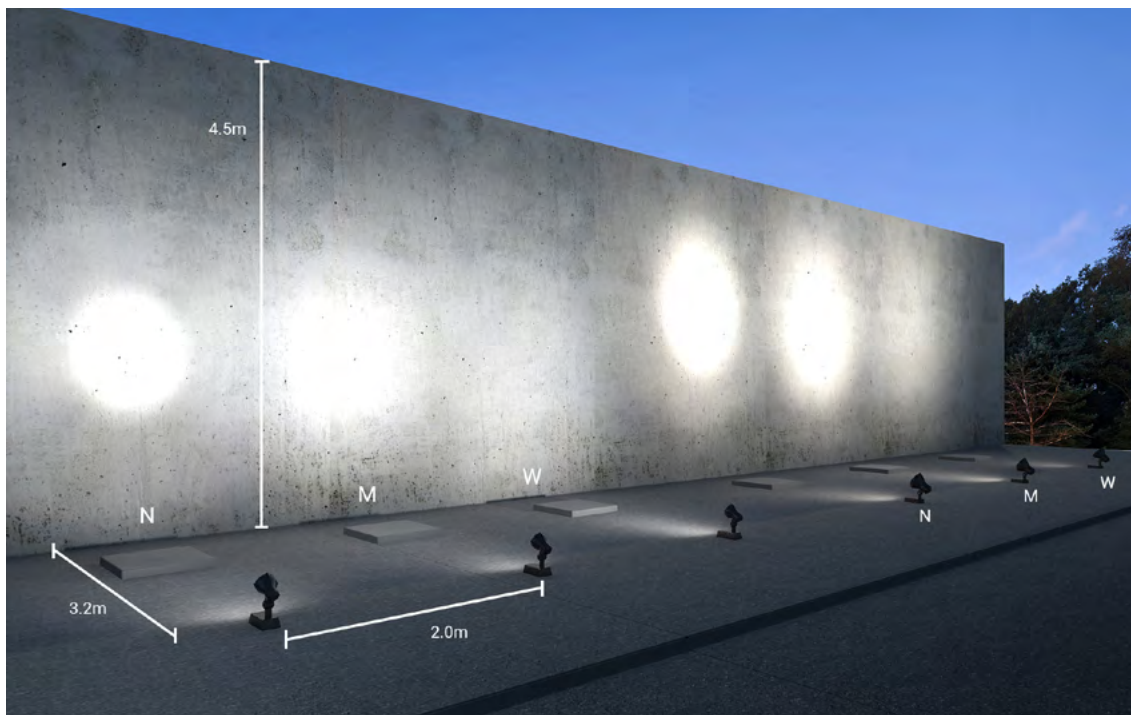

LENA

Proyectores montados en soporte



Familia de foco regulable de brazo largo. Identidad popular, disponible en tres tamaños de fundición y varias opciones de montaje, blindaje y control.



Código de color de luminaria

- 01	- 02	- 03	- 05	- 06
Negro	Gris Oscuro	Blanco	Plata Mate	Bronce
RAL 9011	RAL 7043	RAL 9003	RAL 9006	RAL 6014



Estructura de Luminaria

- Carcasa de aluminio fundido a presión con protección química cromatizada antes del recubrimiento en polvo, lo que garantiza una alta resistencia a la corrosión
- Entrada de cable única
- A través de cableado bajo pedido
- Sujetadores de acero inoxidable en grado 316
- Junta de goma de silicona duradera
- Lente de PMMA de alta eficiencia
- Vidrio transparente templado
- Equipo de control integral

Símbolos de funciones



Símbolos de luz

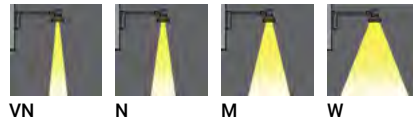

Guía código producto

70880 - N - W30 - DI - 01

Óptica CCT Tipo Dimm Color Luminaria

Temperatura del color
W30 - 3000K
W40 - 4000K

Tipo Regulación
ND - No dimmable
DI - Dimmable 1-10V
DA - Dimmable DALI

Color Luminaria
01 - Negro
02 - Gris Oscuro
03 - Blanco
05 - Plata Mate
06 - Bronce

	Código	Chips	Potencia	Lumen	EEC	Peso	Óptica				CCT	Electrónica
							VN	N	M	W		
Pequeño												
LENA 2	70880	7 LED	13 W	1025 lm	A++	2.7 kg	-	19°	27°	40°	W 30 40	ND DI DA
	70881	12 LED	21 W	2064 lm	A+	2.9 kg	-	16°	28°	42°	W 30 40	ND DI DA
	70882	3 LED	21 W	1798 lm	A+	2.9 kg	8°	-	-	-	W 30 40	ND DI DA
Mediano												
LENA 4	70883	18 LED	29 w	3081 lm	A+	4.0 kg	-	16°	28°	41°	W 30 40	ND DI DA
	70884	24 LED	38 W	4144 lm	A+	4.2 kg	-	15°	26°	45°	W 30 40	ND DI DA
	70885	7 LED	33 W	3230 lm	A+	4.2 kg	8°	-	-	-	W 30 40	ND DI DA
Grande												
LENA 6	70886	24 LED	38 W	4172 lm	A+	5.8 kg	-	15°	26°	44°	W 30 40	ND DI DA
	70887	36 LED	51 W	6140 lm	A+	6.0 kg	-	16°	26°	41°	W 30 40	ND DI DA



Visera antideslumbrante
70610



Visera antideslumbrante
70611



Visera antideslumbrante
70612



Cubierta antideslumbrante
70613



Cubierta antideslumbrante
70614



Cubierta antideslumbrante
70615

70880	•											
70881	•											
70882	•											
70883		•										
70884		•										
70885		•										
70886			•									•
70887			•									•

LENA Projectores montados en soporte



LENA 2

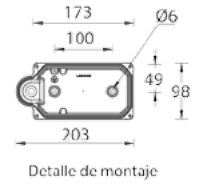
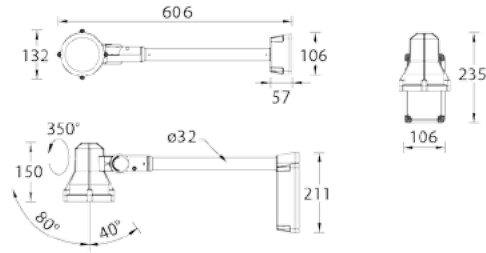

LENA 4

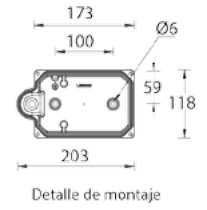
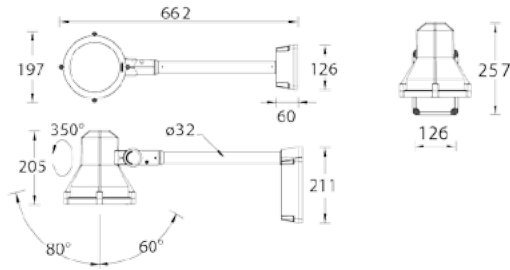

LENA 6

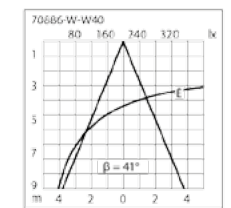
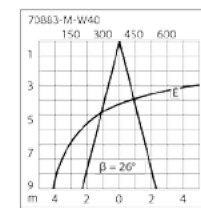
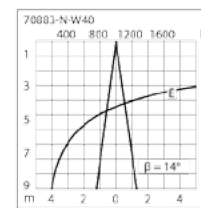
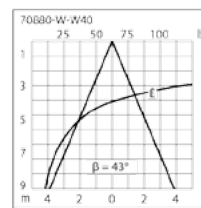
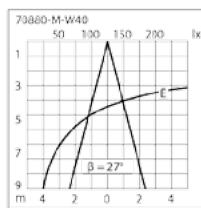
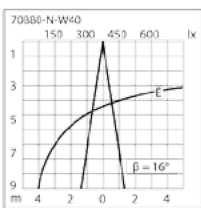
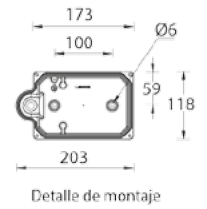
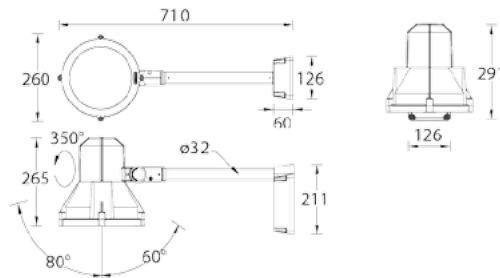

LENNA

Proyectores de pie



Familia de focos de pilares ajustables. Identidad popular, disponible en tres tamaños de fundición y varias opciones de montaje, blindaje y control.



Código de color de luminaria

-01 Negro	-02 Gris Oscuro	-03 Blanco	-05 Plata Mate	-06 Bronce
RAL 9011	RAL 7043	RAL 9003	RAL 9006	RAL 6014



Estructura de Luminaria

- Carcasa de aluminio fundido a presión pretratada antes del recubrimiento en polvo que garantiza una alta resistencia a la corrosión
- Entrada de cable única
- Sujetadores de acero inoxidable en grado 316
- Junta de goma de silicona duradera
- Lente de PMMA de alta eficiencia
- Vidrio transparente templado
- Equipo de control integral instalado en la tapa de la espita

Símbolos de funciones



Símbolos de luz

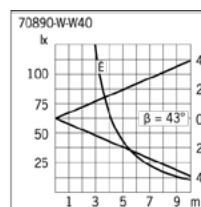
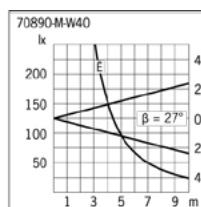
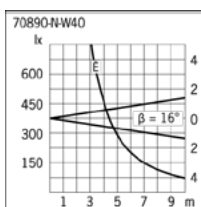
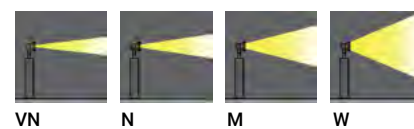

LENA **Proyectores de pie**

Guía código producto

70890 - N - W30 - DI - 01







Óptica CCT Tipo Dimm Color Luminaria

Temperatura del Color
 W30 - Blanco cálido 3000K
 W40 - Blanco neutro 4000K

Tipo Regulación
 ND - No dimmable
 DI - Dimmable 1-10V
 DA - Dimmable DALI

Color Luminaria
 01 - Negro
 02 - Gris Oscuro
 03 - Blanco
 05 - Plata Mate
 06 - Bronce

Código	Chips	Potencia	Lumen	EEC	Peso	Óptica				CCT	Electrónica	
						VN	N	M	W			
Pequeño												
LENA 7	70890	7 LED	13 W	1025 lm	A++	3.3 kg	-	19°	27°	40°	W 30 40	ND DI DA
	70891	12 LED	21 W	2022 lm	A+	3.5 kg	-	16°	28°	42°	W 30 40	ND DI DA
	70892	3 LED	21 W	1798 lm	A+	3.5 kg	8°	-	-	-	W 30 40	ND DI DA
Mediano												
LENA 8	70893	18 LED	29 W	3081 lm	A+	4.9 kg	-	16°	28°	41°	W 30 40	ND DI DA
	70894	24 LED	38 W	4144 lm	A+	5.2 kg	-	15°	26°	45°	W 30 40	ND DI DA
	70895	7 LED	33 W	3230 lm	A++	5.2 kg	8°	-	-	-	W 30 40	ND DI DA
Grande												
LENA 9	70896	24 LED	38 W	4172 lm	A+	6.8 kg	-	15°	26°	44°	W 30 40	ND DI DA
	70897	36 LED	51 W	6140 lm	A+	7.0 kg	-	16°	26°	41°	W 30 40	ND DI DA

						
	70610	70611	70612	70613	70614	70615
70890	•			•		
70891	•			•		
70892	•			•		
70893		•			•	
70894		•			•	
70895		•			•	
70896			•			•
70897			•			•

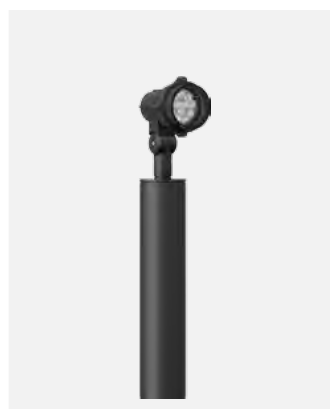

LENA 7

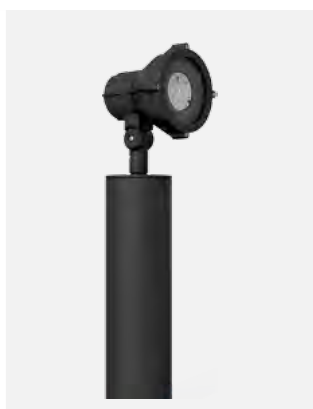

LENA 8

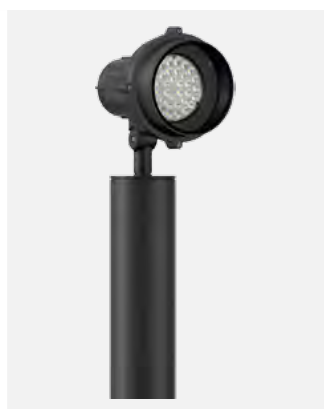

LENA 9

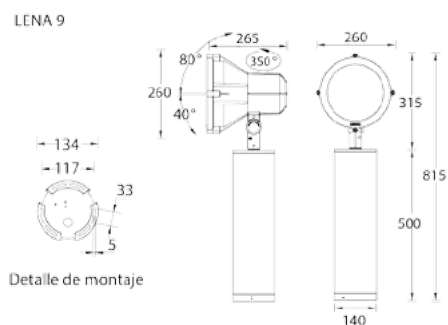
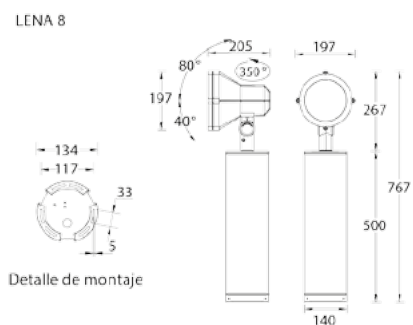
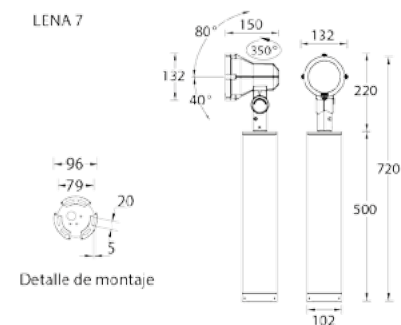



Columna ajustable con foco en solución de racimo. Soluciones de proyecto flexibles en arreglos atractivos de clúster que utilizan la popular serie de focos LENA de factor de forma.

LENA

Proyectores clúster de columna



Código de color de luminaria

- 01	- 02	- 03	- 05	- 06
Negro	Gris Oscuro	Blanco	Plata Mate	Bronce
RAL 9011	RAL 7043	RAL 9003	RAL 9006	RAL 6014



Estructura de Luminaria

- Carcasa de aluminio fundido a presión y columna de aluminio extruido pretratado antes del recubrimiento en polvo que garantizan una alta resistencia a la corrosión
- Entrada de cable única
- Sujetadores de acero inoxidable en grado 316
- Junta de goma de silicona duradera
- Lente de PMMA de alta eficiencia
- Vidrio transparente templado
- Equipo de control integral instalado en la parte superior del poste

Símbolos de funciones



Símbolos de luz

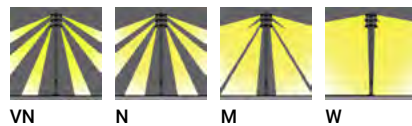

LENA Proyectores clúster de columna

Guía código producto

70900 - N - W30 - DI - 01

Óptica
 CCT
 Tipo Dimm
 Color Luminaria

Temperatura del Color
 W30 - 3000K
 W40 - 4000K

Tipo Regulación
 ND - No dimmable
 DI - Dimmable 1-10V
 DA - Dimmable DALI

Color Luminaria
 01 - Negro
 02 - Gris Oscuro
 03 - Blanco
 05 - Plata Mate
 06 - Bronce

Código	Chips	Potencia	Lumen	EEC	Peso	Óptica				CCT	Electrónica	
						VN	N	M	W			
LENA 3	70900	6 x 18 LED	176 W	18486 lm	A+	49.8 kg	-	16°	28°	41°	W 30 40	ND DI DA
	70901	6 x 24 LED	229 W	24864 lm	A+	49.9 kg	-	15°	26°	45°	W 30 40	ND DI DA
	70902	6 x 7 LED	198 W	19380 lm	A++	49.9 kg	8°	-	-	-	W 30 40	ND DI DA



LENA 3

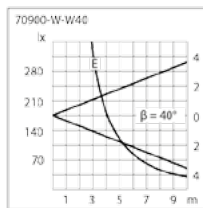
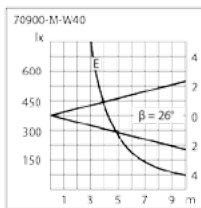
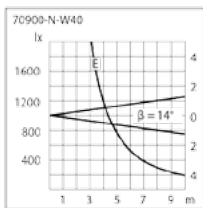
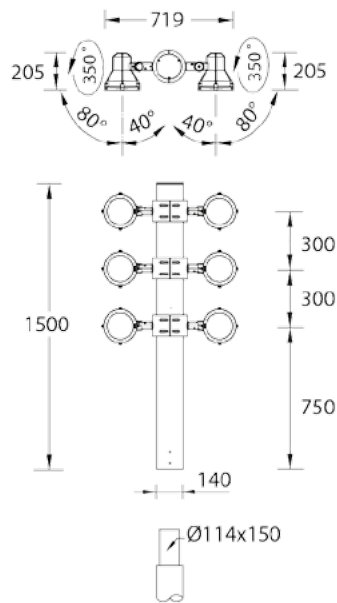



Proyector TALA



Elegante gama de proyectores ajustables. Una familia contemporánea naturalmente hermosa y única, TALA posee una gran cantidad de opciones y accesorios.



Código de color de luminaria

				
-01 Negro	-02 Gris Oscuro	-03 Blanco	-05 Plata Mate	-06 Bronce
RAL 9011	RAL 7043	RAL 9003	RAL 9006	RAL 6014



Estructura de Luminaria

- Carcasa de aluminio fundido a presión pretratada antes del recubrimiento en polvo que garantiza una alta resistencia a la corrosión
- Entrada de cable única
- Cableado a través de pedido para 70912, 70913
- Sujetadores de acero inoxidable en grado 316
- Junta de goma de silicona duradera
- Reflector Óptico de alta eficiencia
- Vidrio transparente templado
- Instalación de montaje en brazo
- Equipo de control integral

Símbolos de funciones



Símbolos de luz

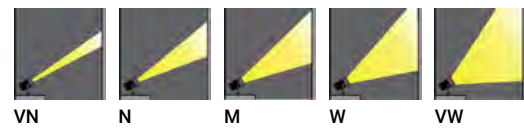

TALA Projectores

Guía código producto

70910 - M - W30 - ND - 01

Óptica
CCT
Tipo Dimm
Color Luminaria

Temperatura del Color
 W30 - 3000K
 W40 - 4000K

Tipo Regulación
 ND - No dimmable
 DI - Dimmable 1-10V
 DA - Dimmable DALI

Color Luminaria
 01 - Negro
 02 - Gris Oscuro
 03 - Blanco
 05 - Plata Mate
 06 - Bronce

Código	Chips	Potencia	Lumen	EEC	Peso	Óptica					CCT	Electrónica	
						VN	N	M	W	VW			
Pequeño													
TALA 1	70910	1 COB	21 W	1653 - 1673 lm	A++	1.7 kg	-	-	23°	32°	47°	W 30 40	ND DI DA
	70911	1 LED	11 W	694 - 816 lm	A+	1.7 kg	8°	-	-	-	-	W 30 40	ND DI DA
Mediano													
TALA 2	70912	1 COB	36 W	2938 - 3458 lm	A++	2.3 kg	-	18°	27°	47°	70°	W 30 40	ND DA
	70913	3 LED	27 W	1704 - 2005 lm	A+	2.3 kg	8°	-	-	-	-	W 30 40	ND DA

	Piqueta 70795	Lente extension lineal 70796	Lumbrea panel aveja 70797	Visera antideslumbrante 70798	Lente extension lineal 70799	Lumbrera antideslumbrante 70800	Visera antideslumbrante 70801
70910	•		•	•			•
70911	•		•	•			•
70912	•	•			•	•	
70913	•	•			•	•	



TALA 1

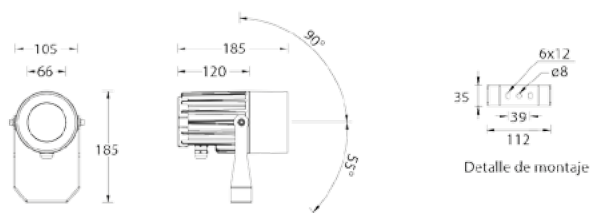

TALA 2

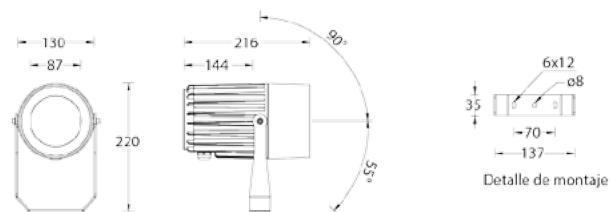

Distribución VN

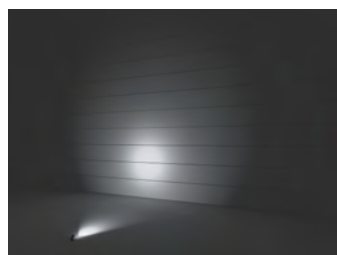

Distribución M

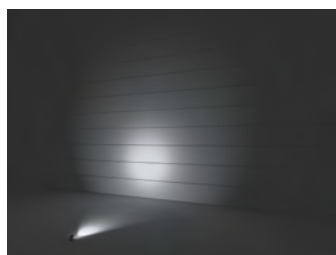

Distribución W

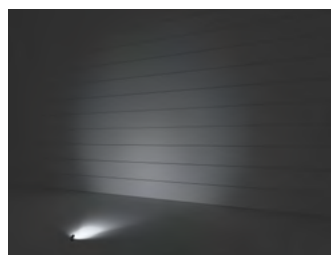

Distribución VW

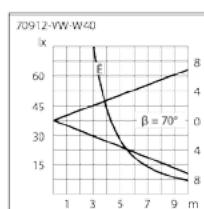
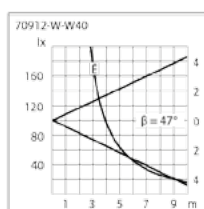
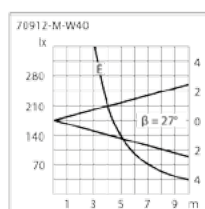
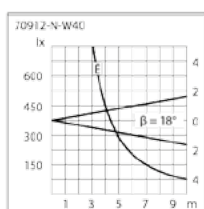
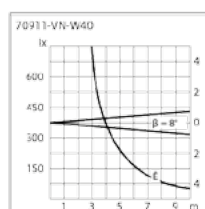



TALA

Proyectores GOBO

Proyector Gobo elegante y potente para combinar con toda la familia de accesorios TALA y una herramienta adicional para grupos, columnas y estructuras.

Longitudes focales opcionales, capaces de admitir gobos de tamaño E de metal y vidrio y protección IP66 con una trampilla de entrada lateral única para el enfoque del sitio y la rotación de gobos



Código de color de luminaria

- 01	- 02	- 03	- 05	- 06
Negro	Gris Oscuro	Blanco	Plata Mate	Bronce
RAL 9011	RAL 7043	RAL 9003	RAL 9006	RAL 6014



Estructura de Luminaria

- Carcasa de aluminio fundido a presión pretratada antes del recubrimiento en polvo que garantiza una alta resistencia a la corrosión
- Entrada de cable única
- Un conector IP68 suministrado con 0,2 m de cable exterior de 3x1,0 mm²
- Sujetadores de acero inoxidable en grado 316
- Junta de goma de silicona duradera
- Cristal de protección frontal templado transparente
- Instalación de montaje en brazo
- Equipo de control integral
- Escotilla de acceso a gobos de entrada lateral sellada
- Lente de colimación trasera interna
- Soporte para gobos (apto para gobos de metal o vidrio)
- Admite gobos estándar de tamaño E
- Tres distancias focales de lentes delanteras opcionales

Símbolos de funciones



Símbolos de luz

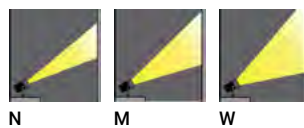

TALA Proyectores GOBO

<p>Guía código producto</p> <p>70914 - N - ND - 70 - 65 - 01</p> <p> Óptica Tipo Dimm CRI CCT Color Luminaria </p>	<p>Tipo Regulación ND - No dimmable DA - Dimmable DALI</p>	<p>Índice de reproducción cromática 70 - Ra>70 Temperatura del color 65 - 6500K</p>	<p>Color Luminaria 01 - Negro 02 - Gris Oscuro 03 - Blanco 05 - Plata Mate 06 - Bronce</p>
---	---	--	---

Código	Chips	Potencia	Lumen	EEC	Peso	Óptica			CRI	CCT	Electrónica	
						N	M	W				
TALA 2-G	70914	1 LED	45 W	1050 - 1184 lm	A+	4.90 kg	12°	18°	32°	70	65	ND I DA

Imágenes de gobo estándar

Hojas Gobo de metal - Tamaño E	Hojas tropicales Gobo de metal - Tamaño E	Ramas Gobo de metal - Tamaño E	Agua Gobo de metal - Tamaño E	Nubes Gobo de metal - Tamaño E	Moon Metal gobo - E Size	Luna Gobo de metal - Tamaño E	Ciudad Gobo de metal - Tamaño E
70920	70921	70922	70923	70924	70925	70926	70927
70914

Diseño personalizado (archivos de imagen proporcionados por el cliente)

PERSONALIZADO - Blanco negro Gobo de vidrio - Ta- maño E	PERSONALIZADO - Escala de grises Gobo de vidrio - Ta- maño E	PERSONALIZADO - 1 color Gobo de vidrio - Ta- maño E	PERSONALIZADO - 2 colores Gobo de vidrio - Ta- maño E	PERSONALIZADO - 3 colores Gobo de vidrio - Ta- maño E	PERSONALIZADO - 4 colores Gobo de vidrio - Ta- maño E	PERSONALIZADO - 5 colores Gobo de vidrio - Ta- maño E
70928	70929	70930	70931	70932	70933	70934
70914



TALA 2-G

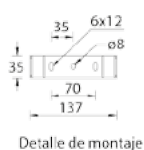
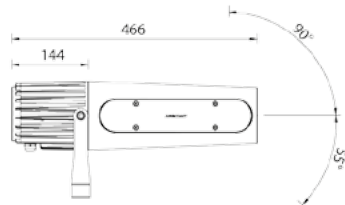

Lente N - 12° (Front Lens Focal Length = 150 mm)

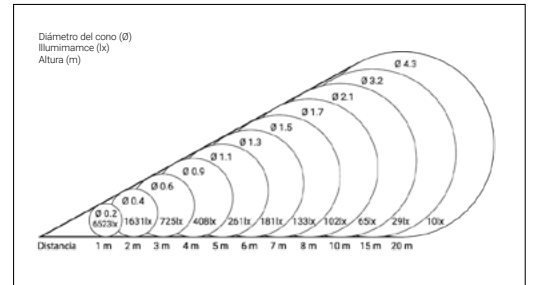

Lente M - 18° (Font Lens Focal Length = 100 mm)

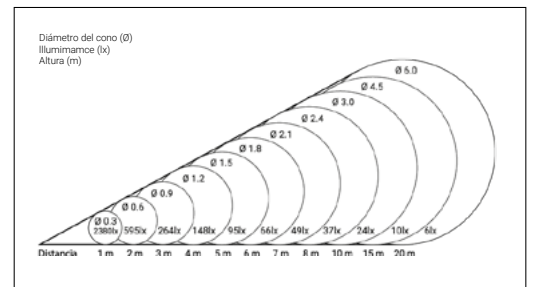

Lente W - 32° (Font Lens Focal Length = 60 mm)

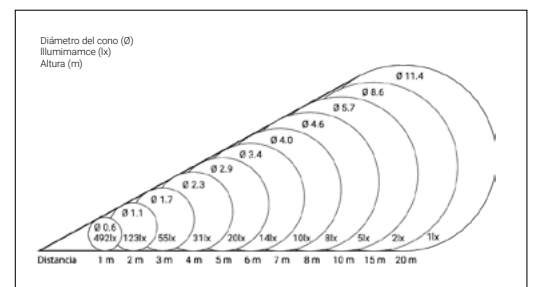





Proyector TALA



Elegante gama de proyectores de base fija. Familia contemporánea naturalmente hermosa y única, TALA tiene un gran impacto con una gran cantidad de opciones y accesorios.



Código de color de luminaria

				
-01 Negro	-02 Gris Oscuro	-03 Blanco	-05 Plata Mate	-06 Bronce
RAL 9011	RAL 7043	RAL 9003	RAL 9006	RAL 6014



Estructura de Luminaria

- Carcasa de aluminio fundido a presión pretratada antes del recubrimiento en polvo que garantiza una alta resistencia a la corrosión
- Entrada de cable única
- Cableado a través de pedido para 70942, 70943
- Sujetadores de acero inoxidable en grado 316
- Junta de goma de silicona duradera
- Reflector Óptico de alta eficiencia
- Vidrio transparente templado
- Instalación de montaje en brazo
- Equipo de control integral

Símbolos de funciones



Símbolos de luz

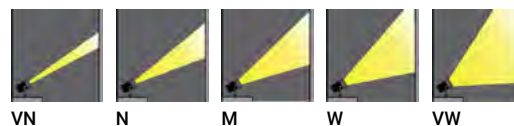

TALA Proyectores

Guía código producto

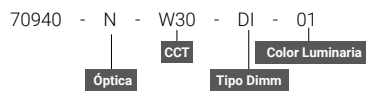

Temperatura del Color
 W30 - 3000K
 W40 - 4000K

Tipo Regulación
 ND - No dimmable
 DI - Dimmable 1-10V
 DA - Dimmable DALI

Color Luminaria
 01 - Negro
 02 - Gris Oscuro
 03 - Blanco
 05 - Plata Mate
 06 - Bronce

Código	Chips	Potencia	Lumen	EEC	Peso	Óptica					CCT	Electrónica	
						VN	N	M	W	VW			
Pequeño													
TALA 5	70940	1 COB	21 W	1653 - 1688 lm	A++	2.8 kg	-	-	23°	32°	47°	W 30 40	ND DI DA
	70941	1 LED	11 W	694 - 816 lm	A+	2.8 kg	8°	-	-	-	-	W 30 40	ND DI DA
Mediano													
TALA 6	70942	1 COB	36 W	3286 - 3224 lm	A++	3.2 kg	-	18°	27°	47°	70°	W 30 40	ND DA
	70943	3 LED	27 W	1704 - 2005 lm	A+	3.2 kg	8°	-	-	-	-	W 30 40	ND DA

	70795	70796	70797	70798	70799	70800	70801
70940	•		•	•			•
70941	•		•	•			•
70942	•	•			•	•	
70943	•	•			•	•	



TALA 5

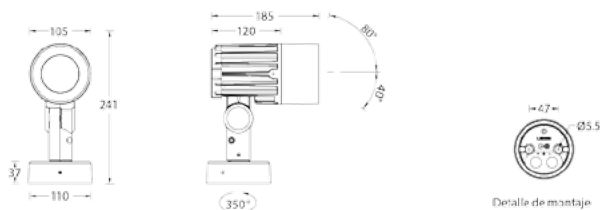

TALA 6

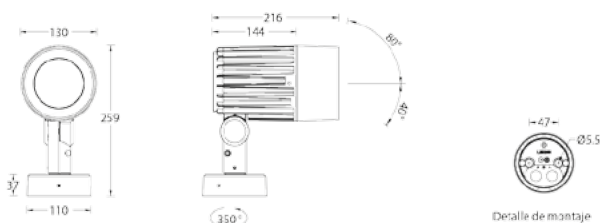



Elegante y potente proyector de gobos de base fija para combinar con toda la familia de luminarias TALA y una herramienta adicional para grupos, columnas y estructuras. Longitudes focales opcionales, capaces de admitir gobos de tamaño E de metal y vidrio y protección IP66 con una trampilla de entrada lateral única para el enfoque del sitio y la rotación de gobos.

TALA

Proyectores GOBO



Código de color de luminaria

- 01 Negro	- 02 Gris Oscuro	- 03 Blanco	- 05 Plata Mate	- 06 Bronce
RAL 9011	RAL 7043	RAL 9003	RAL 9006	RAL 6014

Estructura de Luminaria

- Carcasa de aluminio fundido a presión pretratada antes del recubrimiento en polvo que garantiza una alta resistencia a la corrosión
- Entrada de cable única
- Un conector IP68 suministrado con 0,2 m de cable exterior de 3x1,0 mm²
- Sujetadores de acero inoxidable en grado 316
- Junta de goma de silicona duradera
- Cubierta de vidrio frontal templada transparente
- Ajustable: inclinación 80 ° (arriba) y 40 ° (abajo), rotación 350 °
- Equipo de control integral
- Escotilla de acceso a gobos de entrada lateral sellada
- Lente de colimación trasera interna
- Soporte para gobos (apto para gobos de metal o vidrio)
- Admite gobos estándar de tamaño E
- Tres distancias focales de lentes delanteras opcionales

Símbolos de funciones



Símbolos de luz

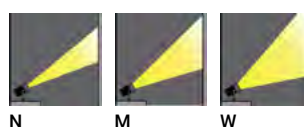

Guía código producto

70915 - N - ND - 70 - 65 - 01

Óptica Tipo Dimm CRI CCT Color Luminaria

Tipo Regulación
 ND - No dimmable
 DA - Dimmable DALI

Índice de reproducción cromática
 70 - Ra>70
Temperatura del color
 65 - 6500K

Color Luminaria
 01 - Negro
 02 - Gris Oscuro
 03 - Blanco
 05 - Plata Mate
 06 - Bronce

Código	Chips	Potencia	Lumen	EEC	Peso	Óptica			CRI	CCT	Electrónica	
						N	M	W				
TALA 2-GF	70915	1 LED	37 W	1050 - 1184 lm	A+	4.90 kg	12°	18°	32°	70	65	ND I DA

Imágenes de gobo estándar

Hojas Gobo de metal - Tamaño E	Hojas tropicales Gobo de metal - Tamaño E	Ramas Gobo de metal - Tamaño E	Agua Gobo de metal - Tamaño E	Nubes Gobo de metal - Tamaño E	Moon Metal gobo - E Size	Luna Gobo de metal - Tamaño E	Ciudad Gobo de metal - Tamaño E
70920	70921	70922	70923	70924	70925	70926	70927

Diseño personalizado (archivos de imagen proporcionados por el cliente)

PERSONALIZADO - Blanco negro Gobo de vidrio - Ta- maño E	PERSONALIZADO - Escala de grises Gobo de vidrio - Ta- maño E	PERSONALIZADO - 1 color Gobo de vidrio - Ta- maño E	PERSONALIZADO - 2 colores Gobo de vidrio - Ta- maño E	PERSONALIZADO - 3 colores Gobo de vidrio - Ta- maño E	PERSONALIZADO - 4 colores Gobo de vidrio - Ta- maño E	PERSONALIZADO - 5 colores Gobo de vidrio - Ta- maño E
70928	70929	70930	70931	70932	70933	70934

TALA Proyectores GOBO



TALA 2-G



Tamaño de patrones

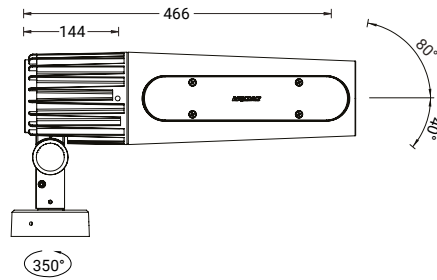
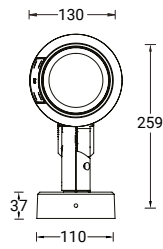

Lente N - 12° (Front Lens Focal Length = 150 mm)

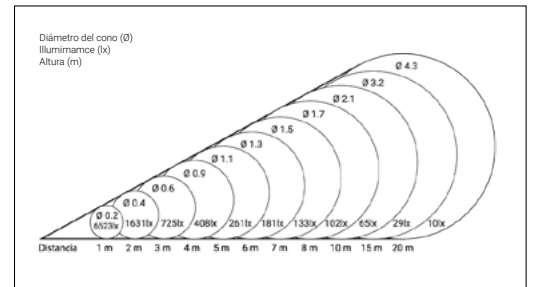

Lente M - 18° (Font Lens Focal Length = 100 mm)

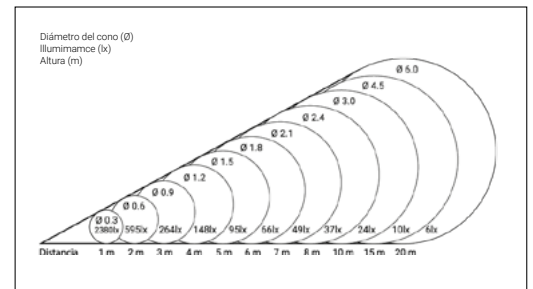

Lente W - 32° (Font Lens Focal Length = 60 mm)

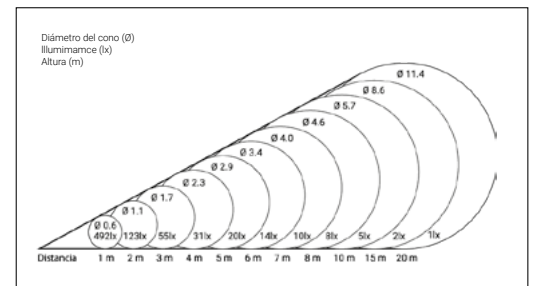



Elegante sistema de marco de triple proyector ajustable TALA, una familia contemporánea, naturalmente hermosa y única, ofrece un gran impacto y este sistema de marco excepcional permite el montaje y la orientación consolidados y ocultos.



TALA

Proyectores clúster montados en superficie

Código de color de luminaria

-01	-02	-03	-05	-06
Negro	Gris Oscuro	Blanco	Plata Mate	Bronce
RAL 9011	RAL 7043	RAL 9003	RAL 9006	RAL 6014



Estructura de Luminaria

- Carcasa de aluminio fundido a presión pretratada antes del recubrimiento en polvo que garantiza una alta resistencia a la corrosión
- Entrada de cable única
- Cableado a través de pedido para 70952, 70953
- Sujetadores de acero inoxidable en grado 316
- Junta de goma de silicona duradera
- Reflector Óptico de alta eficiencia
- Vidrio transparente templado
- Equipo de control integral

Símbolos de funciones



Símbolos de luz

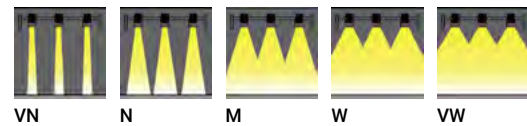

TALA Proyectores clúster montados en superficie

Guía código producto

70950 - N - W30 - DI - 01

Óptica CCT Tipo Dimm Color Luminaria

Temperatura del Color
 W30 - 3000K
 W40 - 4000K

Tipo Regulación
 ND - No dimmable
 DI - Dimmable 1-10V
 DA - Dimmable DALI

Color Luminaria
 01 - Negro
 02 - Gris Oscuro
 03 - Blanco
 05 - Plata Mate
 06 - Bronce

	Código	Chips	Potencia	Lumen	EEC	Peso	Óptica					CCT	Electrónica	
							VN	N	M	W	VW			
Pequeño	TALA 1	70950	3 x 1 COB	63 W	5019 lm	A++	7.3 kg	-	-	23°	32°	43°	W 30 40	ND DI DA
		70951	3 x 1 LED	34 W	2448 lm	A+	7.3 kg	8°	-	-	-	-	W 30 40	ND DI DA
Mediano	TALA 2	70952	3 x 1 COB	109 W	9978 lm	A++	9.1 kg	-	18°	27°	47°	70°	W 30 40	ND DA
		70953	3 x 3 LED	82 W	6015 lm	A+	9.1 kg	8°	-	-	-	-	W 30 40	ND DA

	Lente extension lineal	Lumbrea panel aveja	Visera antideslumbrante	Lente extension lineal	Lumbrera antideslumbrante	Visera antideslumbrante
	70796	70797	70798	70799	70800	70801
70950	•	•	•	•	•	•
70951	•	•	•	•	•	•
70952	•	•	•	•	•	•
70953	•	•	•	•	•	•



TALA 1

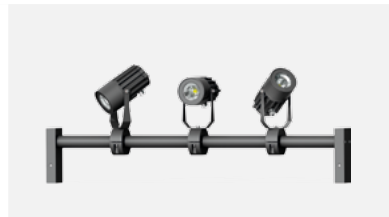

TALA 2

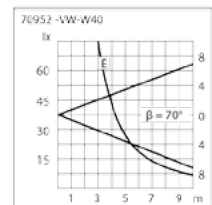
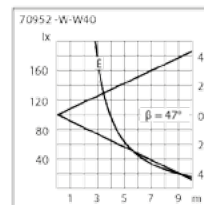
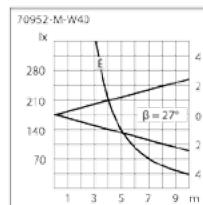
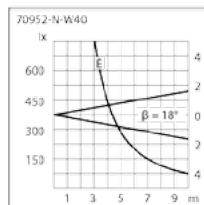
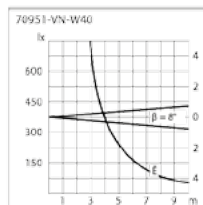
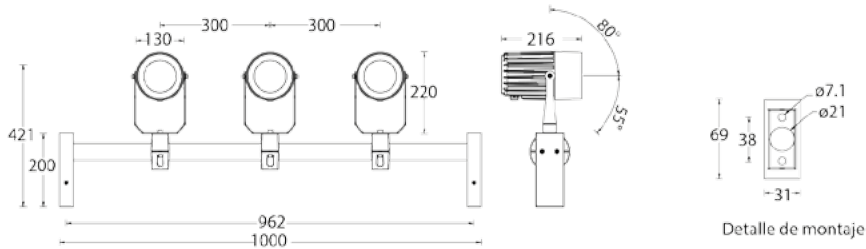
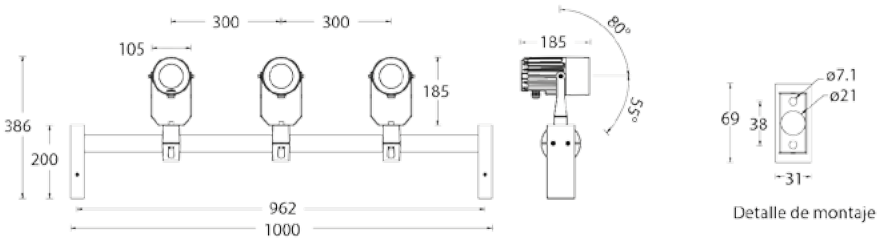

TALA

Proyectores clúster de columna



Solución de agrupación de proyectores de columna con estilo ajustable. Soluciones de proyectores flexibles en arreglos de agrupaciones simétricas utilizando la gama contemporánea, naturalmente hermosa y única de proyectores TALA.



Código de color de luminaria

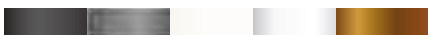

- 01	- 02	- 03	- 05	- 06
Negro	Gris Oscuro	Blanco	Plata Mate	Bronce
RAL 9011	RAL 7043	RAL 9003	RAL 9006	RAL 6014

Símbolos de funciones



Símbolos de luz

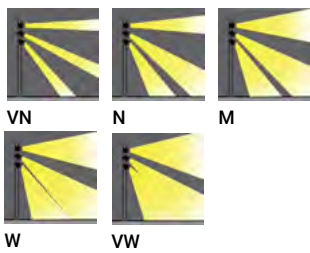

Estructura de Luminaria

- Carcasa de aluminio fundido a presión pretratada antes del recubrimiento en polvo que garantiza una alta resistencia a la corrosión
- Entrada de cable única
- Cableado a través de pedido para 70964, 70965, 70966, 70967
- Sujetadores de acero inoxidable en grado 316
- Junta de goma de silicona duradera
- Reflector óptico de alta eficiencia
- Vidrio transparente templado
- Equipo de control integral
- La resistencia máxima a la carga del viento es de 140 km / h

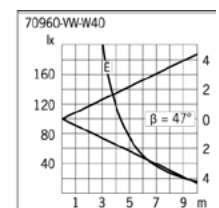
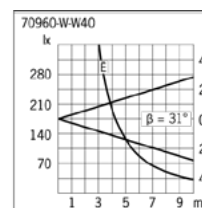
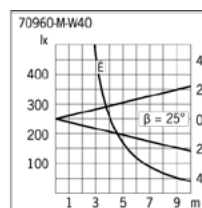
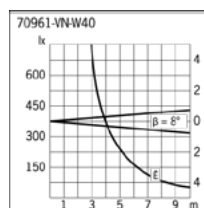

TALA Proyectores clúster de columna

Guía código producto





70960 - M - W30 - DI - 01
 Óptica CCT Tipo Dimm Color Luminaria

Temperatura del Color
 W30 - 3000K
 W40 - 4000K

Tipo Regulación
 ND - No dimmable
 DI - Dimmable 1-10V
 DA - Dimmable DALI

Color Luminaria
 01 - Negro
 02 - Gris Oscuro
 03 - Blanco
 05 - Plata Mate
 06 - Bronce

Código	Chips	Potencia	Lumen	EEC	Peso	Óptica					CCT	Electrónica	
						VN	N	M	W	VW			
3 proyectores - 1 lado													
TALA 1	70960	3 x 1 COB	63 W	5019 lm	A++	7.3 kg	-	-	23°	32°	43°	W 30 40	ND DI DA
	70961	3 x 1 LED	34 W	2448 lm	A+	7.3 kg	8°	-	-	-	-	W 30 40	ND DI DA
TALA 2	70964	3 x 1 COB	109 W	9978 lm	A++	9.1 kg	-	18°	27°	47°	70°	W 30 40	ND DA
	70965	3 x 3 LED	82 W	6015 lm	A+	9.1 kg	8°	-	-	-	-	W 30 40	ND DA
6 proyectores - 2 lados													
TALA 1	70962	6 x 1 COB	126 W	10038 lm	A++	7.3 kg	-	-	23°	32°	43°	W 30 40	ND DI DA
	70963	6 x 1 LED	67 W	4896 lm	A+	7.3 kg	8°	-	-	-	-	W 30 40	ND DI DA
TALA 2	70966	6 x 1 COB	219 W	19956 lm	A++	9.1 kg	-	18°	27°	47°	70°	W 30 40	ND DA
	70967	6 x 3 LED	163 W	12030 lm	A+	9.1 kg	8°	-	-	-	-	W 30 40	ND DA

						
	70796	70797	70798	70799	70800	70801
70960		•	•			•
70962		•	•			•
70961		•	•			•
70963		•	•			•
70964	•				•	
70966	•			•	•	
70965	•			•	•	
70967	•			•	•	



TALA - 1 LADO

TALA 1

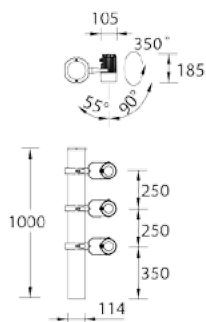

TALA 2

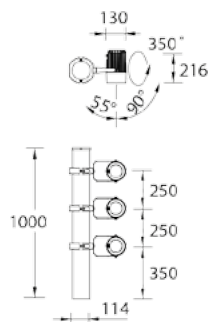

 Ø76x89
 PARTE SUPERIOR POSTE DE ANCLAJE



TALA - 2 LADOS

TALA 1

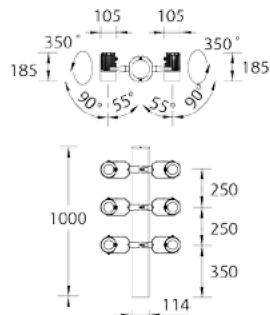

TALA 2

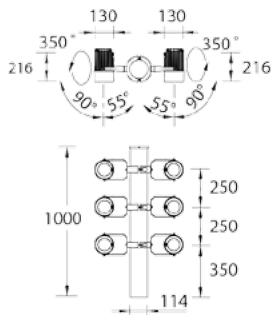

 Ø76x89
 PARTE SUPERIOR POSTE DE ANCLAJE



Proyectores técnicos montados en superficie ajustables.
Soluciones de proyector premium con un diseño moderno
y elegante, protección térmica rotativa única y numerosas
opciones de proyectos.



Código de color de luminaria

-01 Negro	-02 Gris Oscuro	-03 Blanco	-05 Plata Mate	-06 Bronce
RAL 9011	RAL 7043	RAL 9003	RAL 9006	RAL 6014



Estructura de Luminaria

- Carcasa de aluminio fundido a presión pretratada antes del recubrimiento en polvo que garantiza una alta resistencia a la corrosión
- Entrada de cable única
- A través de cableado bajo pedido
- Sujetadores de acero inoxidable en grado 316
- Junta de goma de silicona duradera
- Reflector Óptico de alta eficiencia o lente PMMA
- Vidrio transparente templado
- Equipo de control integral

Símbolos de funciones



Símbolos de luz

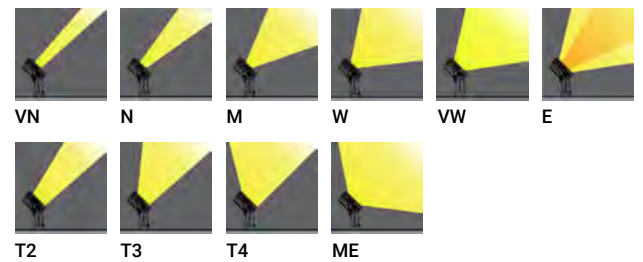

ZANE Projectores

<p>Guía código producto</p> <p>70980 - N - W30 - DI - 01</p> <p> </p>	<p>Temperatura del Color</p> <p>W30 - 3000K W40 - 4000K 30 - RGBW 3000K 40 - RGBW 4000K</p>	<p>Tipo Regulación</p> <p>ND - No dimmable DI - Dimmable 1-10V DA - Dimmable DALI</p>	<p>Color Luminaria</p> <p>01 - Negro 02 - Gris Oscuro 03 - Blanco 05 - Plata Mate 06 - Bronce</p>
---	--	--	--

Código	Chips	Potencia	Lumen	EEC	Peso	Óptica										CCT	Electrónica	
						VN	N	M	W	VW	E	T2	T3	T4	ME			
Small																		
ZANE 1	70980	3 COB	42 W	3634 lm	A++	3.7 kg	-	25°	33°	47°	-	-	-	-	-	-	W 30 40	ND DI DA
	70981	7 LED	32 W	3250 lm	A+	4.0 kg	8°	-	-	-	-	-	-	-	-	-	W 30 40	ND DI DA
Small - RGBW																		
ZANE 1	70982	7 LED	33 W	1185 lm	A	4.0 kg	-	21°	35°	-	-	26° x 48°	-	-	-	-	RGBW 30 40	DMX
Medium																		
ZANE 2	70983	6 COB	104 W	10611 lm	A++	8.5 kg	-	24°	37°	51°	-	-	-	-	-	-	W 30 40	ND DI DA
	70984	18 LED	76 W	7175 lm	A++	8.5 kg	8°	-	-	-	-	-	-	-	-	-	W 30 40	ND DI DA
Medium - RGBW																		
ZANE 2	70985	18 LED	77 W	3555 lm	A	8.5 kg	-	20°	35°	-	-	25° x 48°	-	-	-	-	RGBW 30 40	DMX
Large																		
ZANE 3	70986	6 x 16 LED	269 W	25305 lm	A++	16.0 kg	-	10°	18°	26	70x54	44°x13°	141°x49°	138°x65°	96°x76°	134°x35°	W 30 40	ND DI DA
Large - RGBW																		
ZANE 3	70987	6 x 16 LED	276 W	13539 lm	A	16.0 kg	-	10°	18°	27°	52°x70°	44°x12°	-	-	-	-	RGBW 30 40	DMX

	71000	71001	71002	71003	71004	71005	71006	71007
70980	•							
70982				•				
70981				•				
70983		•						
70985			•					
70984					•			
70986			•				•	
70987			•				•	

	71008	71009	71010	71011	79101	79102	79000
70980			•				
70982			•		•	•	•
70981			•				
70983	•			•			
70985		•			•	•	•
70984	•			•			
70986		•					
70987		•			•	•	•

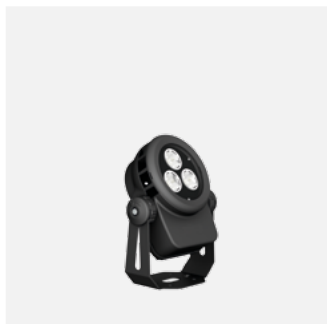

ZANE 1

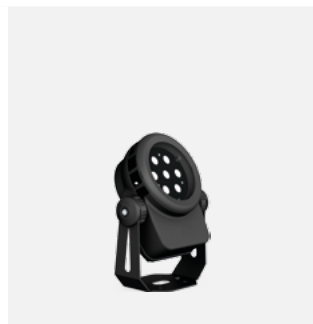

ZANE 1

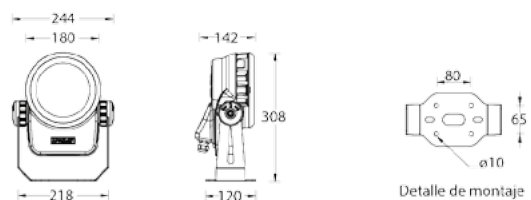

ZANE Projectores



ZANE 2



ZANE 2

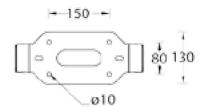
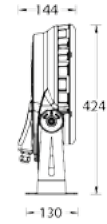

Detalle de montaje



ZANE 3

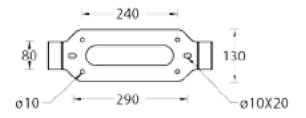
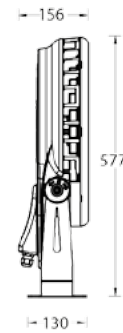
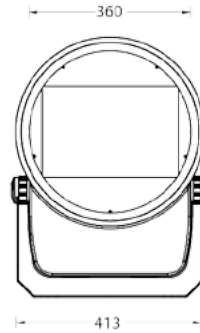

Detalle de montaje



ZANE 1, 70981-W30

Beam: VN/N/M/W



ZANE 1, 70982-E-RGBW30

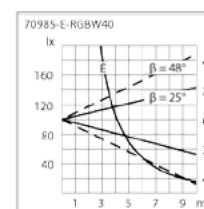
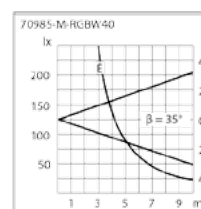
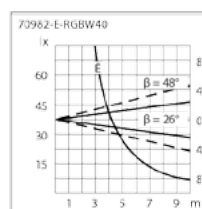
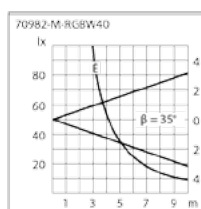
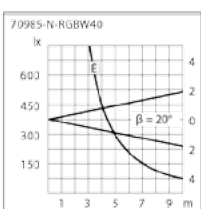
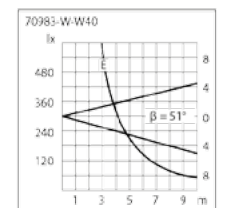
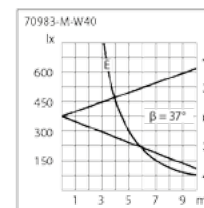
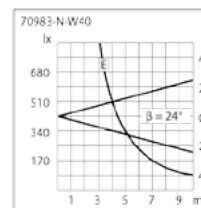
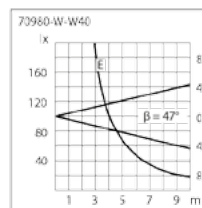
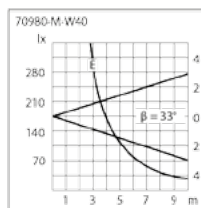
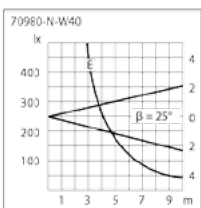



Solución de grupo de proyectores técnicos de columna ajustable. Soluciones de proyectores técnicos flexibles en atractivos arreglos de clústeres utilizando los proyectores premium ZANE.



ZANE

Proyectores clúster de columna

Código de color de luminaria

-01 Negro	-02 Gris Oscuro	-03 Blanco	-05 Plata Mate	-06 Bronce
RAL 9011	RAL 7043	RAL 9003	RAL 9006	RAL 6014



Estructura de Luminaria

- Carcasa de aluminio fundido a presión pretratada antes del recubrimiento en polvo que garantiza una alta resistencia a la corrosión
- Entrada de cable única
- A través de cableado bajo pedido
- Sujetadores de acero inoxidable en grado 316
- Junta de goma de silicona duradera
- Reflector óptico de alta eficiencia o lente de PMMA
- Vidrio transparente templado
- Equipo de control integral

Símbolos de funciones



Símbolos de luz

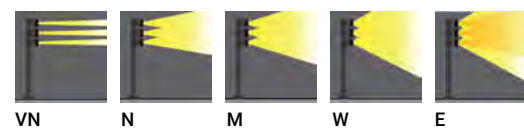

ZANE Proyectores clúster de columna

Guía código producto 70990 - N - W30 - DI - 01 Óptica CCT Tipo Dimm Color Luminaria	Temperatura del Color W30 – 3000K W40 – 4000K 30 – RGBW 3000K 40 – RGBW 4000K	Tipo Regulación ND – No dimmable DI – Dimmable 1-10V DA – Dimmable DALI	Color Luminaria 01 – Negro 02 – Gris Oscuro 03 – Blanco 05 – Plata Mate 06 – Bronce
--	--	---	---

	Código	Chips	Potencia	Lumen	EEC	Peso	Óptica					CCT	Electrónica
							VN	N	M	W	E		
1 lado													
ZANE 1	70990	3 x 3 COB	126 W	10902 lm	A++	36.7 kg	-	25°	33°	47°	-	W 30 40	ND DI DA
	70991	3 x 7 LED	96 W	9750 lm	A++	37.6 kg	8°	-	-	-	-	W 30 40	ND DI DA
1 lado - RGBW													
ZANE 1	70992	3 x 7 LED	99 W	3555 lm	A	37.6 kg	-	20°	35°	-	25° x 48°	RGBW 30 40	DMX
2 lados													
ZANE 1	70993	6 x 3 COB	252 W	21804 lm	A++	47.5 kg	-	25°	33°	47°	-	W 30 40	ND DI DA
	70994	6 x 7 LED	192 W	16740 lm	A++	49.3 kg	8°	-	-	-	-	W 30 40	ND DI DA
2 lados - RGBW													
ZANE 1	70995	6 x 7 LED	198 W	7110 lm	A	49.3 kg	-	20°	35°	-	25° x 48°	RGBW 30 40	DMX

				
	71000	79101	79102	79000
70990	•			
70991				
70992		•	•	•
70993	•			
70994				
70995		•	•	•



ZANE 1 - SENCILLO



ZANE 1 - DOBLE

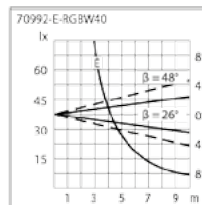
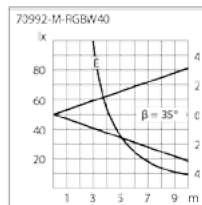
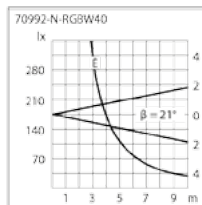
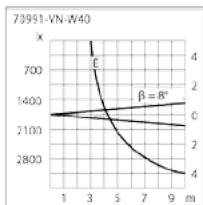
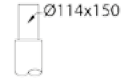
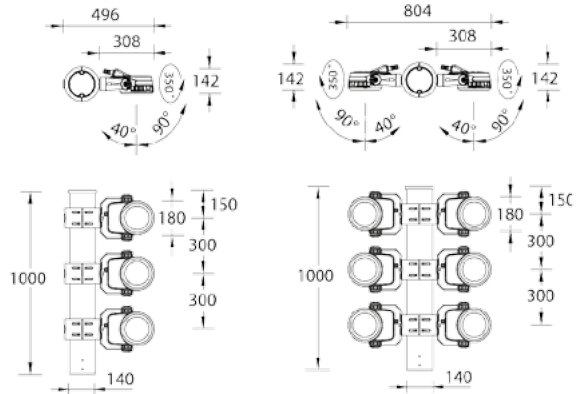



IRISH

Proyector

Gama de proyectores ajustables en miniatura. La simplicidad contemporánea y una huella diminuta permiten a los diseñadores pintar el paisaje con luz y evitar el desorden visual.



Código de color de luminaria

- 01	- 02	- 03	- 05	- 06
Negro	Gris Oscuro	Blanco	Plata Mate	Bronce
RAL 9011	RAL 7043	RAL 9003	RAL 9006	RAL 6014



Símbolos de funciones

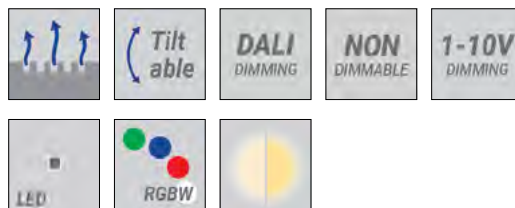

Símbolos de luz



Estructura de luminaria

- Carcasa de aluminio fundido a presión pretratada antes del recubrimiento en polvo que garantiza una alta resistencia a la corrosión
- Entrada de cable única
- Un prensaestopas suministrado con 0,5 m de cable exterior de 2x0,5 mm²
- Sujetadores de acero inoxidable en grado 316
- Junta de goma de silicona duradera
- Lente de PMMA de alta eficiencia
- Vidrio transparente templado
- Incluye equipo de control para 70620
- El controlador remoto no está incluido para 70621, 70622, 70623, 70624
- Pico de tierra de plástico para tipo jardín

Guía código producto

70620 - M - W30 - DI - 01

Óptica Tipo Dimm CCT Color Luminaria

Temperatura del Color
 W30 - 3000K
 W40 - 4000K
 30 - RGBW 3000K
 40 - RGBW 4000K





Tipo Regulación
 ND - No dimmable
 DI - Dimmable 1-10V
 DA - Dimmable DALI

Color Luminaria
 01 - Negro
 02 - Gris Oscuro
 03 - Blanco
 05 - Plata Mate
 06 - Bronce

Código	Chip	Potencia	Lumen	EEC	Peso	Óptica		CCT	Electrónica	
						N	M			
Con driver / piqueta / Visera antideslumbrante - 230V 50/60Hz - Clase I										
IRISH ECO 1	70620*	1 LED	7 W	220 lm	A++	0.27 kg.	-	30°	W 30	ND
Sin driver control remoto / Caja IP - Voltaje Constante (CV) 24V - Clase III										
IRISH 1	70621	1 LED	2 W	164 lm	A++	0.27 kg.	23°	-	W 30 40	ND DI DA
Sin driver control remoto / Caja IP - Voltaje Constante (CV) 24V - Clase III - RGBW										
IRISH 3	70623	1 LED	5 W	195 lm	A++	0.27 kg.	-	33°	RGBW 30 40	DMX
Without remote driver / IP box - Con piqueta - Voltaje Constante (CV) 24V - Class III										
IRISH 2	70622	1 LED	2 W	164 lm	A++	0.27 kg.	23°	-	W 30 40	ND
Sin driver control remoto / Caja IP - Con piqueta - Voltaje Constante (CV) 24V - Clase III - RGBW										
IRISH 4	70624	1 LED	5 W	195 lm	A++	0.27 kg.	-	33°	RGBW 30 40	DMX

* SOLO NEGRO RAL 9011

IRISH Proyectores

					
	70627	79100	79101	79102	79000
76020	•				•
76021	•				•
76022	•	•	•	•	•
76023	•				•
76024	•				•
76025	•	•	•	•	•

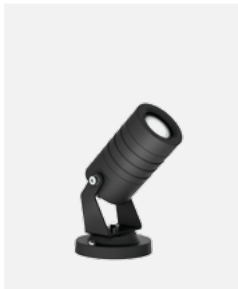

IRISH 1

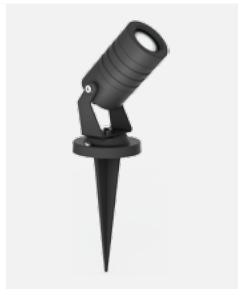

IRISH 2

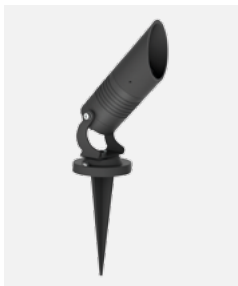
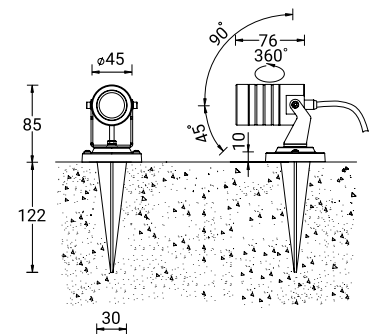
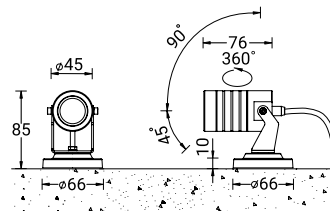

IRISH ECO 1

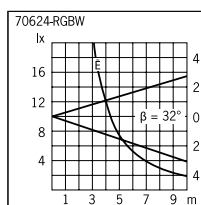
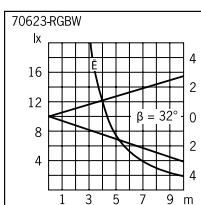
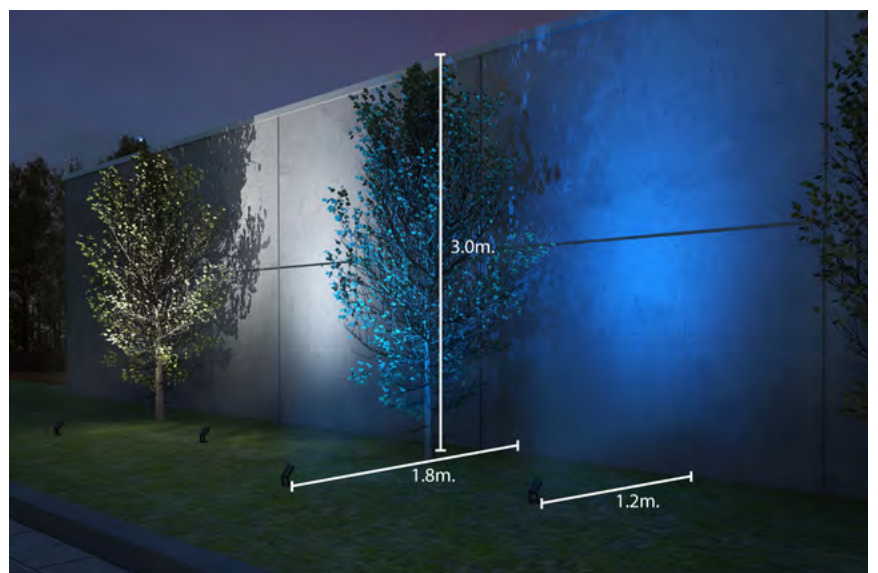
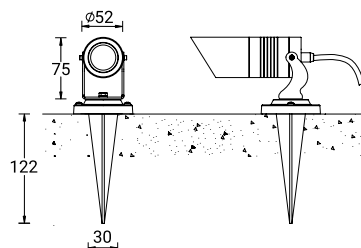





Proyector RACHEL



Familia de foco de superficie ajustable. Gaama de proyectores cónicos y elegantes con una gran cantidad de opciones y accesorios.



Código de color de luminaria

				
-01 Negro	-02 Gris Oscuro	-03 Blanco	-05 Plata Mate	-06 Bronce
RAL 9011	RAL 7043	RAL 9003	RAL 9006	RAL 6014



Estructura de luminaria

- Carcasa de aluminio fundido a presión pretratada antes del recubrimiento en polvo que garantiza una alta resistencia a la corrosión
- Entrada de cable única
- A través de cableado bajo pedido
- Sujetadores de acero inoxidable en grado 316
- Junta de goma de silicona duradera
- Reflector Ópticaal de alta eficiencia
- Vidrio transparente templado
- Equipo de control integral

Símbolos de funciones



Símbolos de luz

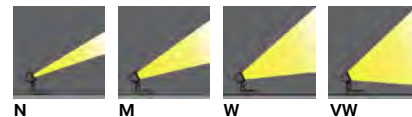

RACHEL Projectores

<p>Guía código producto</p> <p>70630 - N - W30 - DI - 01</p> <p> Óptica CCT Tipo Dimm Color Luminaria </p>	<p>Temperatura del color</p> <p>W30 - 3000K W40 - 4000K</p>	<p>Tipo Regulación</p> <p>ND - No dimmable DI - Dimmable 1-10V DA - Dimmable DALI</p>	<p>Color Luminaria</p> <p>01 - Negro 02 - Gris Oscuro 03 - Blanco 05 - Plata Mate 06 - Bronce</p>
--	---	---	---

Código	Chip	Potencia	Lumen	EEC	Peso	Óptica				CCT	Electrónica	
						N	M	W	VW			
Con caja de montaje												
RACHEL 1	70630	1 COB	21 W	1739 lm	A++	2.8 kg	14°	25°	51°	-	W 30 40	ND DI DA
RACHEL 2	70631	1 COB	40 W	3681 lm	A++	3.7 kg	16°	23°	44°	69°	W 30 40	ND

Lentes lineales extendidas	Filtro color	Filtro color	Filtro color	Filtro color	Filtro color	Lentes lineales extendidas
70640	70642	70643	70644	70645	70641	70646
70630
70631

Filtro color	Filtro color	Filtro color	Lumbrera antideslumbrante	Lumbrera antideslumbrante	Visera antideslumbrante	Cubierta antideslumbrante
70647	70648	70649	70650	70651	70652	70653
70630
70631

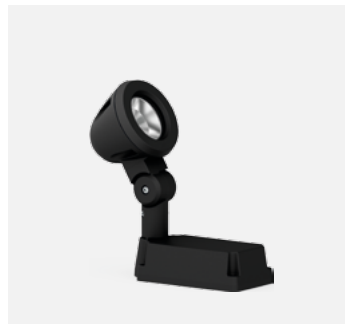

RACHEL 1

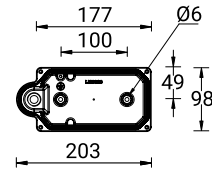
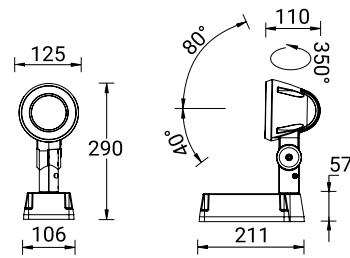

Detalle montaje



RACHEL 2

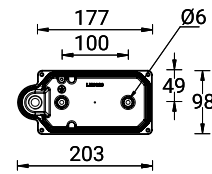
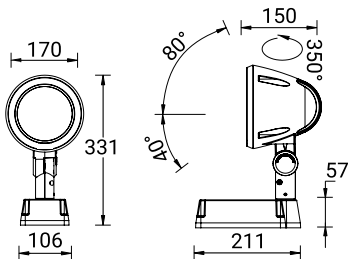

Detalle montaje

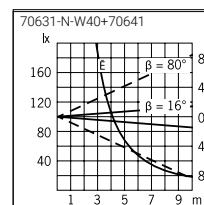
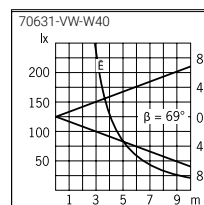
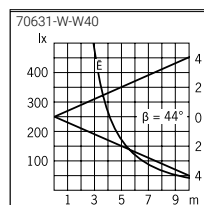
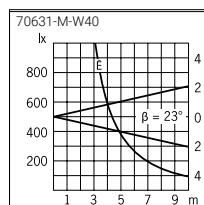
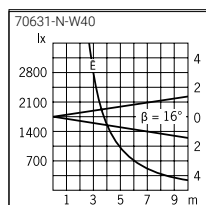



Columna ajustable con foco en solución de racimo. Soluciones de proyector flexibles en atractivos arreglos de clúster que utilizan la elegante gama de proyectores RACHEL de forma cónica.



RACHEL

Proyectores clúster de columna

Código de color de luminaria

- 01	- 02	- 03	- 05	- 06
Negro	Gris Oscuro	Blanco	Plata Mate	Bronce
RAL 9011	RAL 7043	RAL 9003	RAL 9006	RAL 6014



Estructura de Luminaria

- Carcasa de aluminio fundido a presión pretratada antes del recubrimiento en polvo que garantiza una alta resistencia a la corrosión
- Entrada de cable única
- Sujetadores de acero inoxidable en grado 316
- Junta de goma de silicona duradera
- Reflector óptico de alta eficiencia.
- Vidrio transparente templado
- Equipo de control integral instalado en la parte superior del poste de la tapa de la espita

Símbolos de funciones



Símbolos de luz

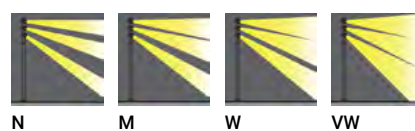

RACHEL Projectores

Guía código producto 71020 - N - W30 - ND - 01

Óptica CCT Tipo Dimm Color Luminaria

Temperatura del Color
 W30 - 3000K
 W40 - 4000K

Tipo Regulación
 ND - No dimmable
 DI - Dimmable 1-10V
 DA - Dimmable DALI

Color Luminaria
 01 - Negro
 02 - Gris Oscuro
 03 - Blanco
 05 - Plata Mate
 06 - Bronce

Código	Chips	Potencia	Lumen	EEC	Peso	Óptica				CCT	Electrónica	
						N	M	W	VW			
Con caja de montaje - Individual												
RACHEL 3	71020	3 x 1 COB	120 W	11043 lm	A++	36.8 kg	16°	23°	44°	69°	W 30 40	ND DI DA
Con caja de montaje - Doble												
RACHEL 3	71021	6 x 1 COB	240 W	22086 lm	A++	43.8 kg	16°	23°	44°	69°	W 30 40	ND DI DA

	Lentes lineales extendidas	Filtro color	Filtro color	Filtro color	Filtro color
	70641	70646	70647	70648	70649
71020	•	•	•	•	•
71021	•	•	•	•	•

	Lumbrera antideslumbrante	Visera antideslumbrante	Cubierta antideslumbrante
	70651	70652	70653
71020	•	•	•
71021	•	•	•



RACHEL 3 - SENCILLO

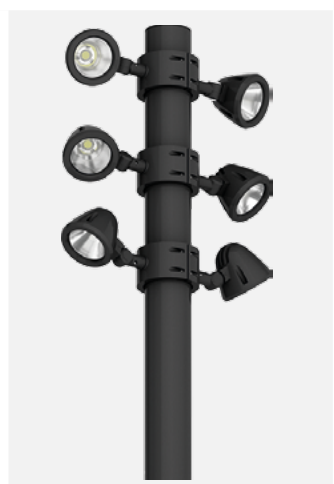

RACHEL 3 - DOBLE

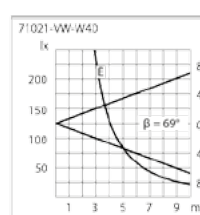
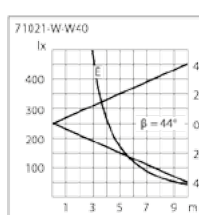
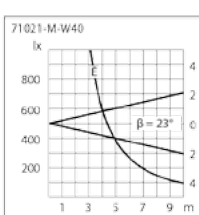
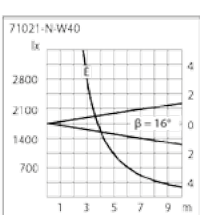
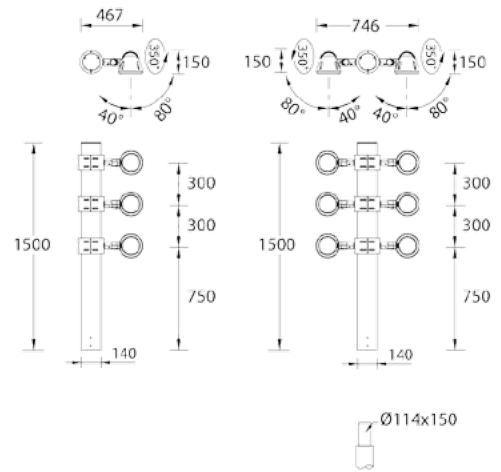

Proyector XIA



Foco regulable. Apariencia robusta y disponible en tres tamaños para una iluminación del paisaje flexible y asequible.



Código de color de luminaria

-01 Negro	-02 Gris Oscuro	-03 Blanco	-05 Plata Mate	-06 Bronce
RAL 9011	RAL 7043	RAL 9003	RAL 9006	RAL 6014



Estructura de Luminaria

- Carcasa y marco de aluminio fundido a presión pretratados antes del recubrimiento en polvo que garantizan una alta resistencia a la corrosión
- Entrada de cable única
- Cableado a través de pedido para 71030, 71031
- Sujetadores de acero inoxidable en grado 316
- Junta de goma de silicona duradera
- Lente de PMMA de alta eficiencia
- Vidrio transparente templado
- Incluye equipo de control para 71030, 71031

Símbolos de funciones



Símbolos de luz

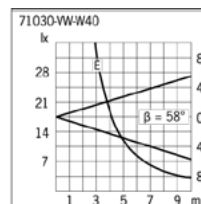
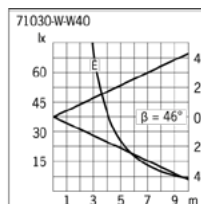
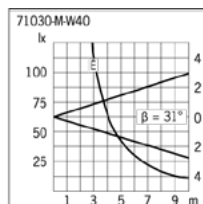
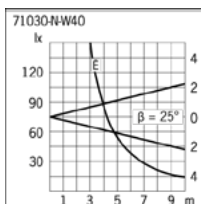
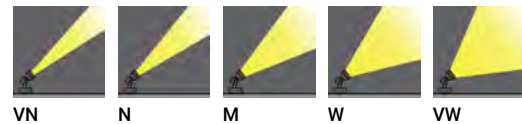

XIA Proyectores

Guía código producto 71030 - N - W30 - DI - 00 Óptica CCT Tipo Dimm Color Luminaria	Temperatura del Color W30 – 3000K W40 – 4000K	Tipo Regulación ND – No dimmable DI – Dimmable 1-10V DA – Dimmable DALI	Color Luminaria 00 – Acero inox 01 – Negro 02 – Gris Oscuro 03 – Blanco 05 – Plata Mate 06 – Bronce
---	--	---	--

Código	Chips	Potencia	Lumen	EEC	Peso	Óptica					CCT	Electrónica	
						VN	N	M	W	VW			
Con driver - 230V 50/60Hz													
XIA 3	71030	1 COB	15 W	1074 lm	A+	1.5 kg	-	26°	32°	46°	60°	W 30 40	ND DI DA
	71031	1 LED	11 W	758 lm	A+	1.5 kg	8°	-	-	-	-	W 30 40	ND DI DA

	 Piqueta 71035	 Cinturón de montaje 71036
71030	•	•
71031	•	•

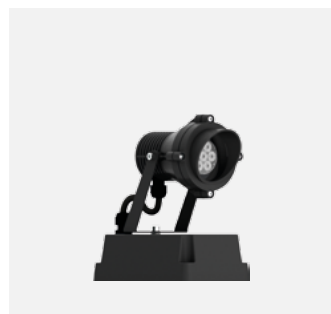

XIA 3

XIA 3

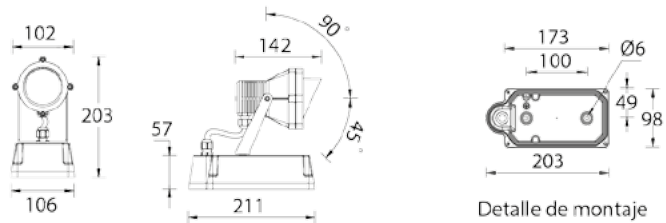

FUENTES DE ALIMENTACIÓN

Gran variedad de fuentes de alimentación, tanto IP20 como IP67, donde se presentan una amplia gama de potencias a 24V.

IP20 Fuentes de alimentación

Referencia	W	Voltaje entrada	Voltaje salida	Corriente salida	Eficiencia	Dimensiones	Material	Temp. de trabajo
80060	60W	170-250VAC	24V	2.5A	86%	170 x 34 x 23	Metal	-30°C a +50°C
80061	100W	170-250VAC	24V	4.2A	86%	140 x 49 x 29	Metal	-30°C a +50°C
80062	150W	170-250VAC	24V	6.25A	86%	195 x 49 x 29	Metal	-30°C a +50°C
80063	200W	170-250VAC	24V	8.3A	86%	195 x 49 x 29	Metal	-30°C a +50°C
80064	250W	170-250VAC	24V	10.4A	86%	230 x 64 x 35	Metal	-30°C a +50°C



Referencia	W	Voltaje entrada	Voltaje salida	Corriente salida	Eficiencia	Dimensiones	Material	Temp. de trabajo
LRS-35-24	35W	85-264VAC	24V	1.5A	88%	99 x 82 x 30	Metal	-30°C a +70°C
LRS-50-24	50W	85-264VAC	24V	2.2A	88%	99 x 82 x 30	Metal	-30°C a +70°C
LRS-75-24	75W	85-264VAC	24V	3.2A	90%	99 x 97 x 30	Metal	-30°C a +70°C
LRS-100-24	100W	85-264VAC	24V	4.5A	90%	129 x 97 x 29	Metal	-30°C a +70°C
LRS-150-24	150W	85-264VAC	24V	6.5A	89%	159 x 97 x 35	Metal	-30°C a +70°C



Referencia	W	Voltaje entrada	Voltaje salida	Corriente salida	Eficiencia	Dimensiones	Material	Temp. de trabajo
RSP-200-24	200W	88-264VAC	24V	8.4A	89,5%	215 x 115 x 30	Metal	-30°C a +70°C
RSP-320-24	320W	88-264VAC	24V	13.4A	89%	215 x 115 x 30	Metal	-30°C a +70°C
RSP-500-24	500W	85-264VAC	24V	21A	89%	230 x 127 x 40,5	Metal	-30°C a +70°C
RSP-750-24	750W	90-264VAC	24V	31.3A	90.5%	250 x 127 x 41	Metal	-30°C a +70°C
RSP-1000-24	1000W	90-264VAC	24V	40A	88%	295 x 127 x 41	Metal	-30°C a +70°C



IP67 Fuentes de alimentación

Referencia	W	Voltaje entrada	Voltaje salida	Corriente salida	Eficiencia	Dimensiones	Material	Temp. de trabajo
80065	20W	100-240V	24V	0.84A	80%	143 x 30 x 23	Plástico	-30°C a +50°C
80066	36W	100-240V	24V	1.5A	80%	148 x 42 x 30	Plástico	-30°C a +50°C
80067	60W	100-240V	24V	2.5A	80%	166 x 43 x 34	Plástico	-30°C a +50°C
80068	75W	100-240V	24V	3.13A	80%	166 x 43 x 34	Plástico	-30°C a +50°C
80069	100W	100-240V	24V	4.2A	80%	192 x 53 x 36	Plástico	-30°C a +50°C



Referencia	W	Voltaje entrada	Voltaje salida	Corriente salida	Eficiencia	Dimensiones	Material	Temp. de trabajo
80070	100W	90-264VAC	24V	4.17A	85%	182 x 62 x 17	Metal	-30°C a +50°C
80071	150W	176-264VAC	24V	6.25A	85%	198 x 58 x 32	Metal	-30°C a +50°C
80072	200W	176-264VAC	24V	8.3A	85%	238 x 58 x 32	Metal	-30°C a +50°C
80073	250W	176-264VAC	24V	10.5A	85%	228 x 72 x 32	Metal	-30°C a +50°C
80074	300W	176-264VAC	24V	12.5A	85%	228 x 72 x 32	Metal	-30°C a +50°C



Referencia	W	Voltaje entrada	Voltaje salida	Corriente salida	Eficiencia	Dimensiones	Material	Temp. de trabajo
LPV-20-24	20W	90-264VAC	24V	0.84A	83%	118 x 35 x 26	Plástico	-30°C a +50°C
LPV-20-24	35W	90-264VAC	24V	1.5A	85%	148 x 40 x 30	Plástico	-30°C a +65°C
LPV-20-24	60W	90-264VAC	24V	2.5A	86%	162,5 x 42,5 x 32	Plástico	-30°C a +70°C
LPV-20-24	100W	90-264VAC	24V	4.2A	88%	190 x 52 x 37	Plástico	-25°C a +70°C
LPV-20-24	150W	180-305VAC	24V	6.3A	89%	191 x 63 x 37,5	Plástico	-25°C a +65°C



Referencia	W	Voltaje entrada	Voltaje salida	Corriente salida	Eficiencia	Dimensiones	Material	Temp. de trabajo
ELG-200-24	200W	100-305VAC	24V	8.4A	92%	244 x 71 x 37,5	Metal	-40°C a +85°C
ELG-240-24	240W	100-305VAC	24V	10A	92%	244 x 71 x 37,5	Metal	-40°C a +85°C
ELG-300-24	300W	100-305VAC	24V	12.5A	93%	246 x 77 x 39,5	Metal	-40°C a +90°C



Dispositivos de control DMX

DMX

Un innovador dispositivo de control DMX que permite la gestión de la iluminación de todas las luces con cambio de color dinámico. Estos dispositivos ofrecen soluciones flexibles para todos los requisitos.



Gama	79100	79101
Windows XP / Vista / Seven	32/64 bits	32/64 bits
conexión USB		• •
Conexión ethernet		•
conexión a Internet		
Software de grabación DMX (PC)		•
Software Easy Stand Alone (PC)		• •
Software Easy Stand Alone 2 (PC / Mac)		• •
Software ESA Pro (PC)		•
Software Sunlite Suite 2 (PC)		
Software Easy View 3D (PC)	Modo limitado	Modo limitado
Canales DMX	256	2 x 512
Numero de escenas	20	250
Numero de zonas	1	5
Stand Alone memory	20K	microSD
Capacidad de memoria (pasos) con 20 canales	1184	Ilimitado
Capacidad de memoria (pasos) con 60 canales	439	Ilimitado
Capacidad de memoria (pasos) con 512 canales		Ilimitado
Potencia voltaje	5-5.5V DC 300mA Hasta 16v con Potencia externa (no USB)	5-5,5 V CC 300 mA
Conector Potencia	mini USB	mini USB
Botones mecánicos		3 3
Botones sensibles al tacto		
Conector de extensiones HE10 interno		•
Activación de puertos	8	8
Activación del reloj		40
Disparo RS232		
Activación de audio		
Mando a distancia por infrarrojos		•
Control remoto de teléfono inteligente WIFI		•

Rango STICK	79102
Diseño	En plastico
Dimensiones	130 x 170 x 11 mm
Peso	177 g
conexión USB	•
Conexión ethernet	•
Canales DMX	2 x 512
Software Easy Stand Alone (PC)	•
Software Easy Stand Alone 2 (PC / Mac)	•
Software ESA Pro (PC)	•
Software de grabación DMX	
Software Sunlite Suite 2 (PC)	•
Software Easy View 3D (PC)	Modo completo
Aplicación STICK Remote (iOS / Android)	•
Aplicación Arcolis (iOS / Android)	•
Numero de escenas	200
Numero de zonas	5
Stand Alone memory	microSD
Capacidad de memoria (pasos) con 20 canales	Límite de tarjeta SD
Capacidad de memoria (pasos) con 60 canales	Límite de tarjeta SD
Capacidad de memoria (pasos) con 512 canales	Límite de tarjeta SD
Potencia voltaje	5-10 V CC 300 mA 5,5 V máx. Con USB
Conector Potencia	Terminal de tornillo
Control en vivo	Color, atenuador, velocidad
Botones sensibles al tacto	15
Activación de puerto	8 (255 en binario)
Activación del reloj	40
Disparo RS232	•
Activación de audio	Solo KU1
Disparo por infrarrojos	•
Adaptador AC / DC	Accesorio Potencia4M
Mando a distancia por infrarrojos	Accesorio IR-REMOTE
RJ45 a placa CONNECTOR BLOCK	

DMX y Sistema de control

Las luminarias LYOPRO RGBW se pueden integrar fácilmente en el sistema DMX que ha sido diseñado para ofrecer la solución de control de iluminación perfecta para cualquier entorno. Los mensajes de datos DMX se envían directamente desde el STICK a las luminarias. El controlador DMX de la luminaria escucha los mensajes DMX y suministra la Potencia al dispositivo de iluminación y los mensajes DMX se transmiten al siguiente dispositivo de iluminación.

ESA es un controlador de iluminación DMX512 independiente basado en USB que permite programar escenarios de iluminación dinámicos de forma rápida y sencilla. Las nuevas escenas de iluminación se pueden activar en función de un calendario o reloj de tiempo, mediante controladores externos o pueden funcionar de forma continua. Debido a que ESA es un controlador independiente, una vez que se carga el espectáculo de luces, el programador de scence puede desconectar la computadora y marcharse sabiendo que ESA está controlando los efectos de iluminación.

Diagrama de bloques del sistema DMX

Sistema pequeño total máximo 60 luminarias RGBW

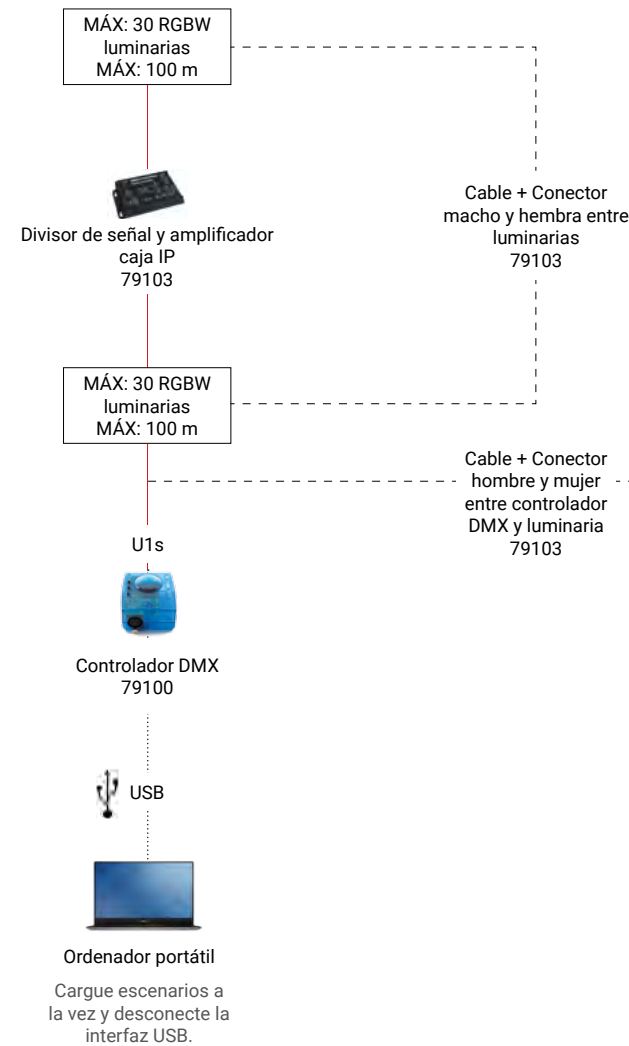

Sistema medio total máximo 256 luminarias RGBW

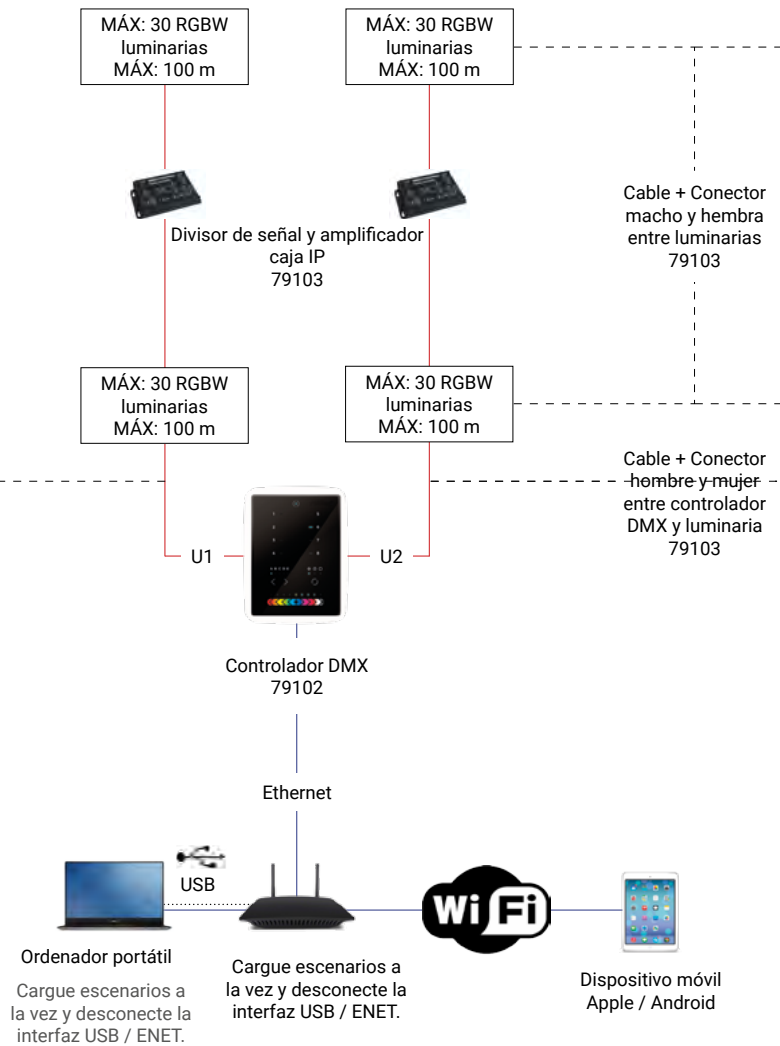

— Cable DMX
U1s, Universo 1: 256 direcciones en modo independiente

..... Conexión USB

— Cable DMX
U1, Universo 1: 512 direcciones
U2, Universo 2: 512 direcciones

— Cable de ethernet

..... Conexión USB

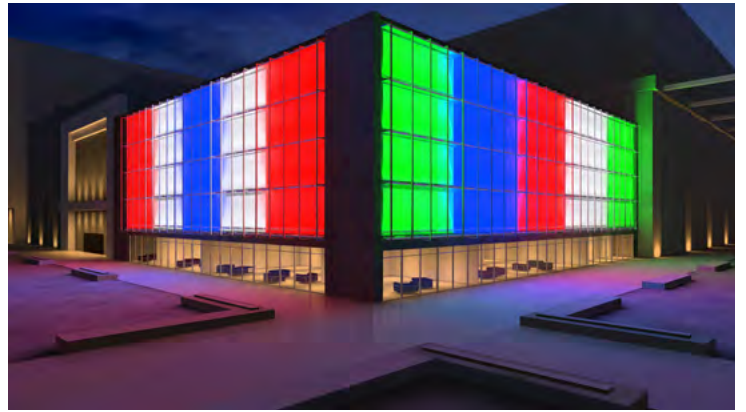

Gran sistema total de luminarias con un máximo de 256+ RGBW

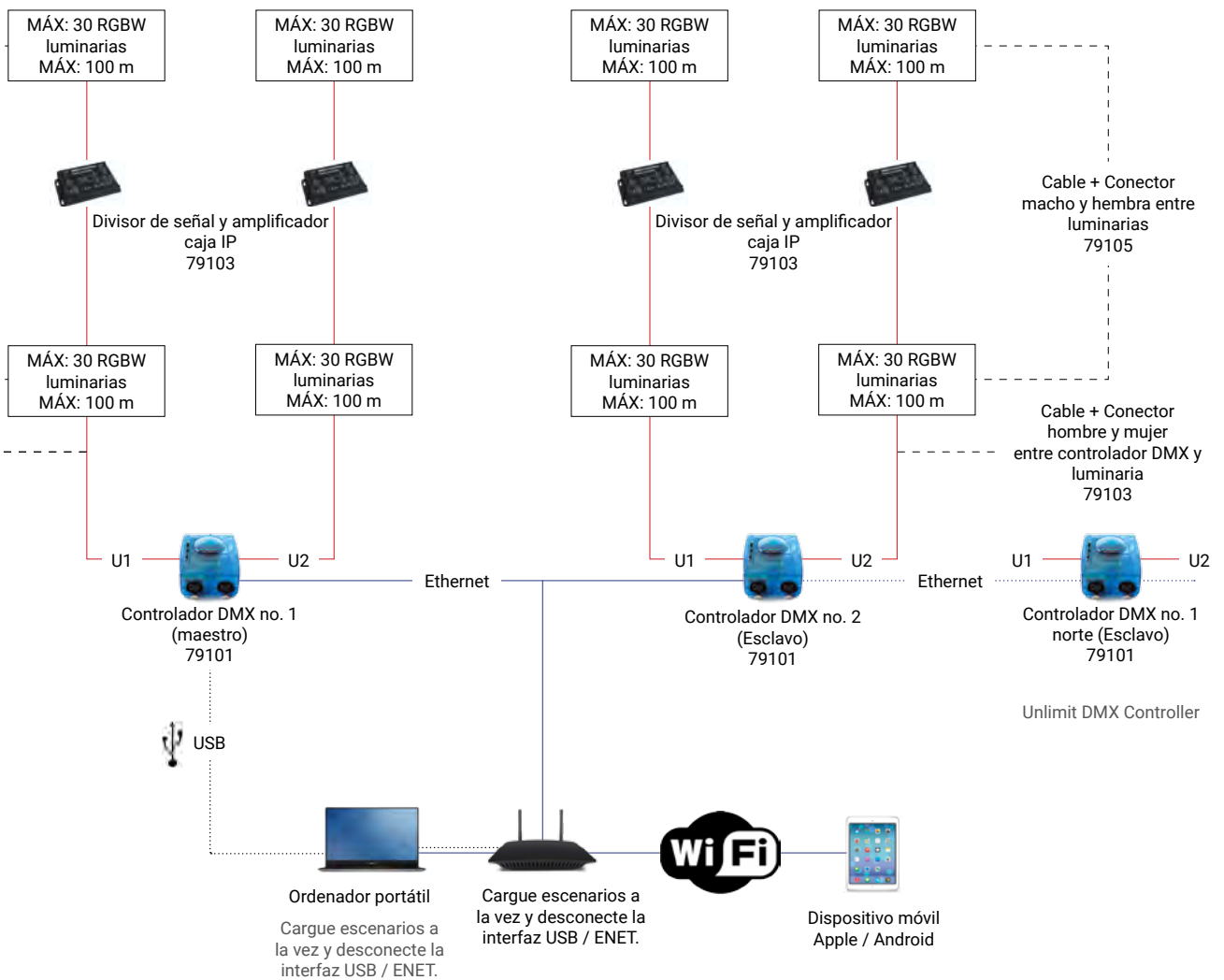

- Cable DMX
U1, Universo 1: 512 direcciones
U2, Universo 2: 512 direcciones
- Cable de ethernet
- Conexión USB

Información fotométrica

El catálogo de LYOPRO contiene información fotométrica, curvas de distribución de intensidad polar, diagramas de iluminación isolux, diagramas de haz de iluminación, diagramas de haz de iluminación en el suelo. La siguiente información describe cómo leer la fotometría como información básica.



Diagrama de isolux

La iluminancia indica la intensidad con la que se ilumina una superficie. La distribución de la iluminancia en una superficie se presenta mediante el diagrama de isolux. Todos los puntos de idéntico nivel de iluminancia están conectados por una línea. Las variaciones en la altura de montaje (H) o la orientación de una luminaria (inclinación) darán como resultado un diagrama alterado.

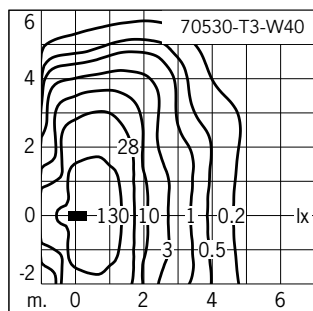

Diagrama de iluminancia y haz

Estos diagramas para proyectores y proyectores especifican las dimensiones del área definida por los dos ángulos de haz medio y el grado medio de iluminancia de esta área, dependiendo de la distancia.

El ángulo de medio haz define el área donde la luminaria irradia al menos la mitad (50%) de su intensidad luminosa máxima. La intensidad luminosa completa solo se logra en el centro del círculo de luz.

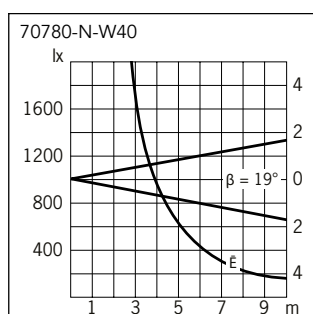
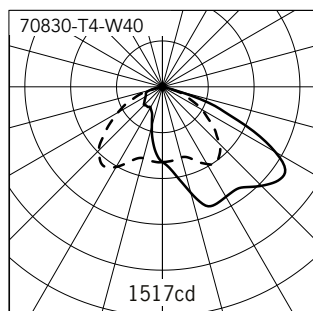

Curva de distribución de intensidad polar

Esta curva indica en qué dirección y con qué intensidad emite luz una luminaria. La intensidad luminosa en candelas (cd) para un ángulo dado se obtiene multiplicando el valor leído en el diagrama en cd / klm por el flujo luminoso total en kilolumen (klm) de la fuente de luz en la luminaria.

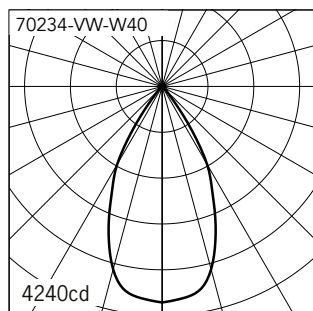

Para distribuciones de luz asimétricas, las secciones están etiquetadas para indicar a qué plano C a través de la luminaria se refieren las curvas.

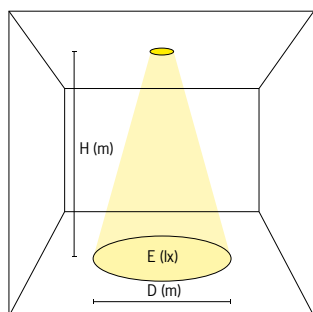

H (m)	E (lx)	D (m)
1	4240	1.0
2	1060	2.0
3	471	3.0
4	265	4.0
5	170	5.1
6	118	6.1

Iluminancia y ancho del haz en el suelo

La tabla anterior muestra la altura de la luminaria relacionada con la iluminación E (lx) y la D (m) muestra un diámetro del haz de luz en el piso objetivo. Este downlight tiene 170 lx y una dimensión de haz media de \varnothing 5,1 m en el suelo cuando la altura de montaje es de 5 m.

Símbolos

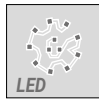

Módulo LED circular o cuadrado de alta potencia LYOPRO

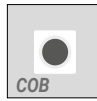

El COB de alta potencia LYOPRO

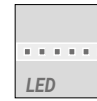

Módulo lineal de LED de alta potencia LYOPRO



El módulo LED individual de alta potencia LYOPRO



Módulo LED circular o lineal de baja potencia LYOPRO



RGBW mezcla de colores / cambiando



Temperatura del color 3000K y 4000K



Temperatura del color 2700K, 3000K y 4000K

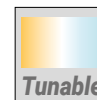

Blanco sintonizable 2700K - 6500K



No regulable



Regulación DALI



Atenuación 1-10V



Luminaria antideslumbrante



Luminaria de bajo deslumbramiento



Accesorio antideslumbrante



Corte 80° (Downlight)



Corte 80° (luz ascendente)



Diferentes tamaños



Diferentes largos



Rotación de 355 grados



Luminaria basculante



Cuerpo de luminaria con diseño de disipador



Instalación sin herramientas



Bluetooth



Cableado



Clase I, con disposiciones para la clase II



Gobo projector

CONDICIONES GENERALES DE VENTA

FORMALIZAR UN PEDIDO IMPLICA LA ACEPTACIÓN DE ESTAS CONDICIONES DE VENTA GENERALES

Todas las ventas se realizan bajo las condiciones relacionadas a continuación. Cualquier especificación que no se ajuste a estas condiciones tendrá que ser antes aceptada por escrito por LYOPRO.

PRESUPUESTOS

Los presupuestos tendrán una validez máxima de 30 días naturales desde la fecha de su emisión.

GARANTÍA Y CALIDAD

Todos nuestros productos están garantizados (consultar en cada caso la ficha técnica en www.lyopro.es) contra cualquier defecto de fabricación. Esta garantía no cubre deterioros sufridos por el uso o aplicación indebida, incorrecta manipulación, una no correcta instalación cuando el producto haya sido usado fuera de su capacidad, maltratado, golpeado, así como cualquier otra falla atribuible al cliente o consumidor o cuando la falla sea original por el desgaste normal de las piezas debido a su funcionamiento o instalación. Queda fuera de garantía todo material manipulado por personal no autorizado por la empresa. Pequeñas diferencias entre nuestros productos en cuanto a tamaño, color, calidad o cualquier otra modificación en el producto, no serán motivo de reclamación por parte del comprador. Cualquier reclamación imputada en cuanto a cantidad, calidad u otros defectos serán comunicadas a LYOPRO, en un plazo máximo de 48 horas a la recepción de la mercancía, transcurrido este plazo no dará lugar a reclamación alguna. Para la ejecución de la garantía mediante abono o reposición es imprescindible recibir el material en cuestión para poder ser analizado y determinar que ésta procede. Requisito indispensable en toda garantía la presentación de factura y comprobante de pago y rellenando el RMA correspondiente. LYOPRO en continua mejora de la calidad y funcionalidad de sus productos se reserva el derecho a modificar o suprimir cualquiera de estos sin previo aviso sin que ello sea motivo de reclamación por parte del cliente.

PLAZO DE ENTREGA

Los plazos de entrega son sólo aproximados y sin compromiso, no admitiéndose demanda por daños y perjuicios por parte del cliente por demora de la entrega, ni otras demandas o indemnizaciones por incumplimientos contractuales. El incumplimiento del plazo de entrega no faculta al cliente a la rescisión del contrato de compra sin la concesión de un plazo prudencial de tiempo para solucionar dicha demora (importaciones de materiales y productos varios (60-90 días). Las causas de fuerza mayor (guerras, revoluciones, huelgas, catástrofes naturales, roturas de maquinaria, roturas de moldes o matrices, imposibilidad de adquisición de materia prima, interrupción del transporte, cierre de aduanas o cualquier otra medida oficial que pudiera afectar, etc.) nos da el derecho a demorar el plazo de entrega sin previo aviso. Cada operación es una expedición independiente, aunque varias de ellas formen parte de un mismo pedido.

PRECIOS / PORTES

Serán los establecidos en nuestra web a excepción de acuerdos explícitos confirmados por LYOPRO.

PORTES: Condiciones válidas únicamente en territorio peninsular español. Portes pagados a partir de 300€ y **Islas Canarias:** Portes pagados a partir de 600€. Debido a errores de imprenta, evolución de los productos o a las constantes fluctuaciones de la materia prima, LYOPRO se reserva el derecho de variar los precios sin previo aviso.

PEDIDOS

Todos los pedidos deberán confirmarse por escrito (devolviendo la hoja de pedido que se pase por correo electrónico) antes de que entren en funcionamiento. Todo pedido que supere los 1.500 € el cliente deberá abonar el 50% por adelantado antes del inicio de la fabricación (en concepto de reserva). En todos los pedidos de materiales que no hayan sido cursados por escrito (E-mail) LYOPRO no se hace responsable si hay disconformidad con lo que pidió y se sirvió. Ningún pedido cuya forma de pago sea transferencia entrará en funcionamiento antes de recibir el resguardo del pago.

ANULACIONES-DEVOLUCIONES DE PEDIDOS

No se aceptarán devoluciones transcurridos 15 días desde la entrega de material. Los pedidos pasados en firme no pueden ser anulados sin la conformidad de LYOPRO. En caso de devolución por causas ajenas a LYOPRO, el material será abonado con un 20% de demérito (con un mínimo de 10 €). No se aceptará ninguna devolución de materiales sin la autorización expresa de LYOPRO y con la hoja de devolución cumplimentada. De igual forma no se aceptará ninguna devolución a portes debidos si el motivo de dicha devolución es error de LYOPRO será LYOPRO quien envíe su agencia). No se aceptará responsabilidad ni reclamación alguna que sobrepase la reposición del material enviado o el pago de éste al precio al que fue adquirido. Ningún producto fabricado a medida ó traído expresamente para el cliente (que no se encuentre en stock habitual) será reembolsado, no teniendo derecho el cliente a reclamación alguna.

RESERVA DE PROPIEDAD

La mercancía suministrada queda en nuestra total propiedad hasta su pago. El derecho de propiedad subsiste aún después de que el comprador haya revendido el producto, hasta que no haya cancelado la deuda con LYOPRO.

TRANSPORTE

Cualquier anomalía del material recibido o incidencia del transporte deberá ser reflejada en el albarán que se firma al transportista o perderá el derecho a reclamación. El cliente deberá posteriormente darnos el aviso de la incidencia antes de las 24h posteriores a la entrega, no responsabilizándose en ningún caso si la reclamación es posterior a lo indicado. Es de competencia del cliente ejercer sus acciones con los transportistas en caso de pérdida, avería o retraso de la mercancía. El cliente tiene la obligación de examinar la mercancía en el momento de la entrega y anotar cualquier anomalía. No poner reparo en el talón o albarán de la agencia de transporte se entenderá que es de su conformidad. Si el cliente no ha dado instrucciones especiales de expedición, la mercancía se enviará según nuestro mejor parecer y por medio de transporte elegido por LYOPRO.

PAGO

Las condiciones de pago serán las acordadas con nuestros clientes. Los vencimientos de los pagos mediante cualquier documento de pago legalmente aceptado, deberán de respetarse puntualmente. En caso contrario estamos facultados a cargar los intereses de demora, así como los quebrantos ocasionados por la demora en el pago. Las demoras en el pago traen consigo con efecto inmediato la anulación de todos los compromisos de LYOPRO para con el cliente. El comprador no está autorizado a retener la totalidad a parte de los pagos vencidos por no habersele reconocido alguna reclamación, ya que ésta no le exime de su compromiso de pago. Todo impagado o retraso en el pago anula la posibilidad del crédito, paralizando el suministro de materiales en tanto no se regularice la situación. Si esta situación fuera repetitiva, se procederá a comunicarlo a CRÉDITO & CAUCIÓN cancelándose el crédito de forma irrevocable.

FUERO

Para cuantas cuestiones y discrepancias se deriven de la presente operación, comprador y vendedor se someten expresamente a la competencia de los jueces y tribunales de los Juzgados de Valencia con renuncia a cualquier otro fuero propio o reserva de dominio que pudiera corresponder.

COSTAS Y GASTOS

Los gastos y costas judiciales, incluso honorarios de Abogado y derechos de Procurador, serán siempre por cuenta de la parte contratante que hubiera dado lugar a ellos por incumplimiento de estas condiciones generales de venta o del contrato en general.

DERECHO SUPLETORIO

El presente contrato de venta se regirá por lo aquí convenido y en su defecto por las normas del Código de Comercio Español para las ventas en España.

LEDs Y ORDENACIÓN S.L. (LYOPRO) CIF: B98495526

C/ SEQUIA DE RASCAÑA, 14, NAVE 6, 46210. PICAÑA (VALENCIA)

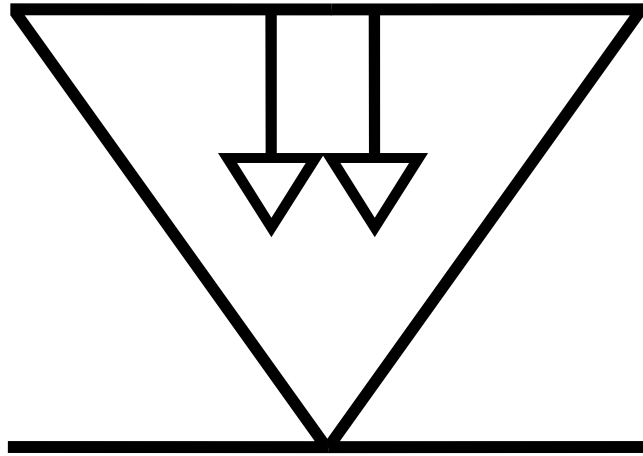

LYOPRO

PRIME

Lighting with you

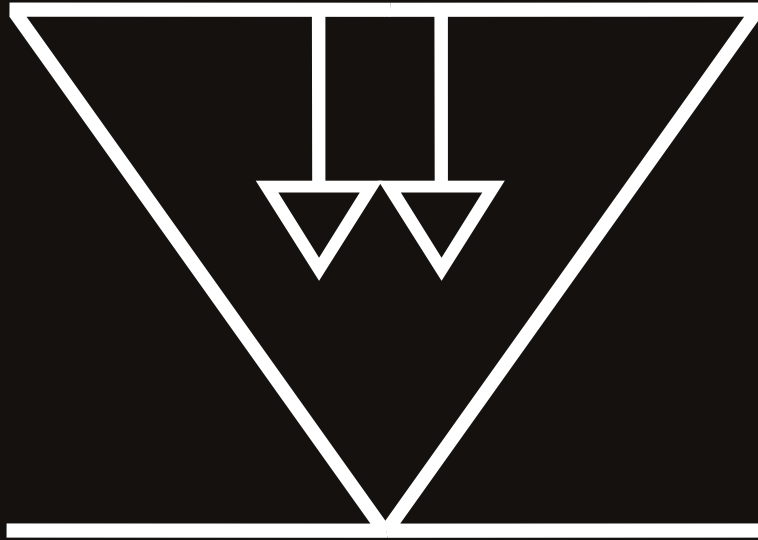

Lighting with you

Síguenos en:



Pol. Ind. Alquería de Moret
Sequia Rascaña, 14, nave 6 · 46210 PICAÑA (Valencia)
Telfn.: +34 963 21 50 93 · info@lyopro.es
www.lyopro.es