



BOOK 2020  
LED LIGHTING  
SOLUTION

**Ω HOME**GA<sup>®</sup>  
ILLUMINAZIONE

# INDEX

## INTERNO

### PANNELLI

|                            |    |
|----------------------------|----|
| PANNELLI LED 60X60         | 08 |
| PANNELLO LED 60X60 UGR<19  | 09 |
| PANNELLO LED 30X120        | 10 |
| PANNELLO LED 30X120 UGR<19 | 11 |
| PANNELLO BACKLITE          | 12 |

### INCASSI

|                      |    |
|----------------------|----|
| ERCOLE               | 16 |
| ERCOLE IP54          | 17 |
| VULCANO EVO          | 18 |
| LEDSPOT_TRP1         | 20 |
| QUADRO_30            | 22 |
| DIN                  | 24 |
| DON                  | 25 |
| SPLASH               | 27 |
| HELIOS_50 FISSO      | 28 |
| HELIOS_50 REGOLABILE | 29 |

### SOFFITTO / PARETE

|                |    |
|----------------|----|
| PLAFOLED_T     | 32 |
| PLAFOLED_Q     | 33 |
| HYDRA T        | 34 |
| HYDRA Q        | 35 |
| PANNELLO TONDO | 36 |
| ISIDE          | 37 |
| MAYA           | 38 |
| DISCO          | 39 |
| LUCE QUADRO    | 40 |

### INDUSTRIALE

|                    |    |
|--------------------|----|
| HORUS              | 44 |
| ATON               | 45 |
| PRO_STAGNALED_IP65 | 46 |
| STAGNA_IP65        | 47 |
| CARONTE            | 48 |

## INTERNO

### PROIETTORI

|                 |    |
|-----------------|----|
| ATLANTE         | 52 |
| LAMPO           | 54 |
| LAMPO C/SENSORE | 58 |

### SOFFITTO / PARETE

|            |    |
|------------|----|
| ZAGOR      | 62 |
| MOON       | 63 |
| LUNA_T     | 64 |
| LUNA_O     | 65 |
| LADY_T     | 66 |
| LADY_Q     | 67 |
| SIGNUS     | 68 |
| PROTEO     | 69 |
| WALLY      | 70 |
| WALLY OPEN | 71 |
| ELEGANT    | 72 |
| RINGO      | 73 |
| KANDO_T    | 74 |
| KANDO_Q    | 75 |
| BRICK      | 76 |

### TRANSFORMERS E ACCESSORI 80

### PRICE LIST 82

# PANNELLI INTERNO

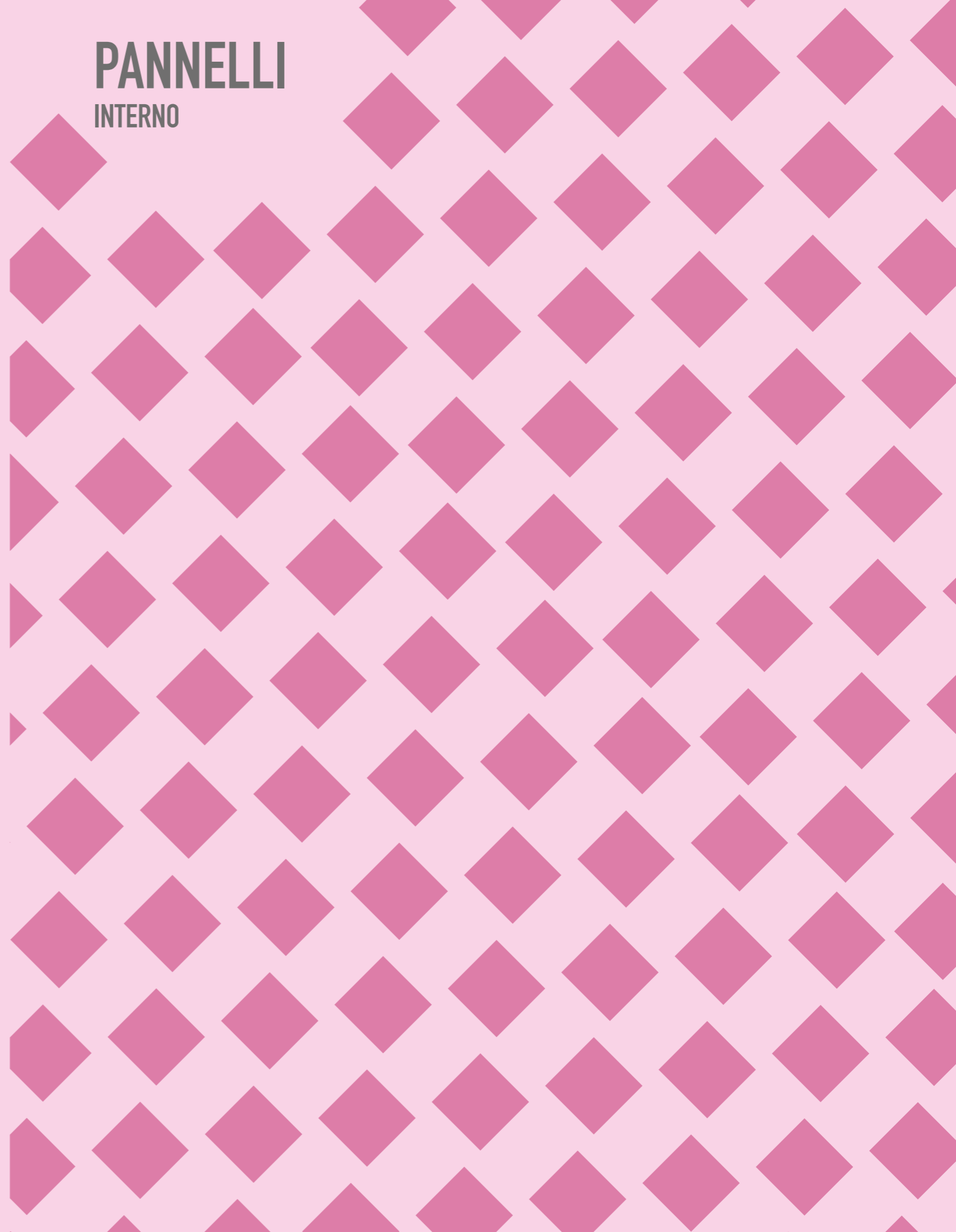

# PANNELLO\_LED

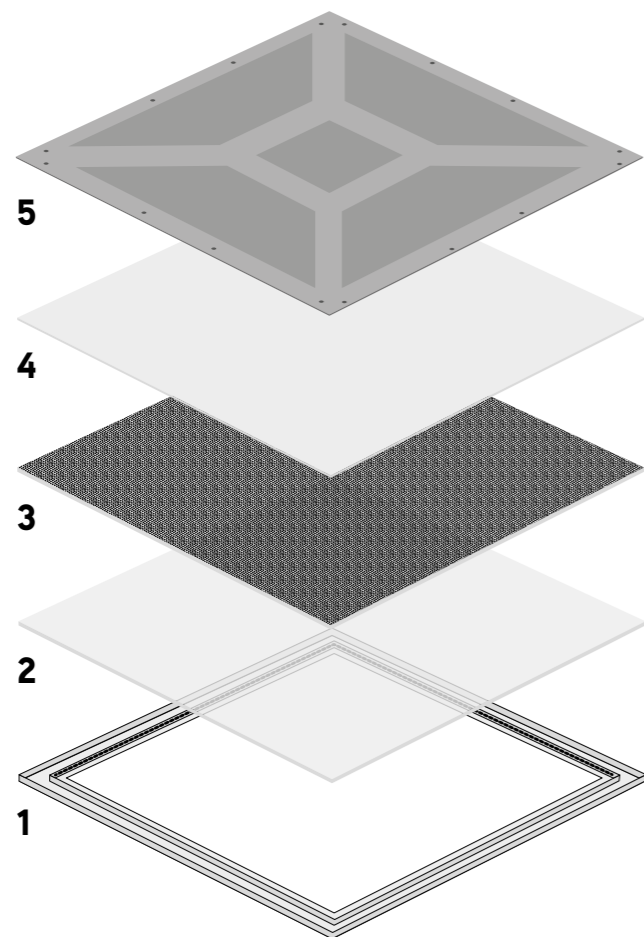

**CORNICE ALLUMINIO CON STRISCE LED**  
 Profilo in alluminio da 290 gr concepito per una migliore dissipazione del calore e dotato di una struttura meccanicamente più stabile. Cornice di alluminio con striscia LED con chip 4014 ad alta efficienza anziché chip 2835 a bassa efficienza luminosa.

**ALUMINIUM FRAME WITH LED STRIPS**  
 Aluminium frame with 290g structure provides a better heat dissipation and a more stable mechanical structure. Led strips high lumen efficiency 4014 chip instead of low efficiency 2835 chip.

**DIFFUSORE**  
 Diffusore in PS da 1,2 mm garantisce l'uniformità dell'emissione ed il mantenimento della temperatura colore (\*K). Non usiamo diffusori in PP che ingialliscono in breve tempo modificando la temperatura di colore.

**DIFFUSER**  
 1,2 mm PS diffuser ensures light smoothness and colour temperature maintenance (\*K) over time. We do not mount PP diffusers which turn yellowish and modify the colour temperature in a very short time

**LGP**  
 In PMMA da 2,8 mm di qualità assicura un alto indice di mantenimento del flusso luminoso anziché PP o PS che causano un decadimento del flusso luminoso nel breve periodo.

**LGP**  
 2,8 mm quality PMMA LGP ensures high luminous flux maintenance over time instead of PP or PS which cause a drastic lumen depreciation.

**CARTA RIFLETTENTE**  
 Foglio PET a doppio rivestimento che migliora l'efficienza luminosa.

**PAPER REFLECTOR**  
 Double coated PET sheet which improves light efficiency.

**TAMPONAMENTO DI CHIUSURA**

**CLOSING SHEET**



# PANNELLO\_LED 60X60



Apparecchio da incasso/  
soffitto/sospensione LED integrato  
Corpo in alluminio verniciato  
LGP in PMMA  
Diffusore in PS  
Driver incluso

Recessed/ceiling/suspension fitting  
with built-in LED  
Painted aluminium body  
PMMA LGP  
PS Diffuser  
Driver included

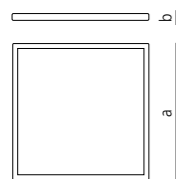

**42538**  
cornice per montaggio cartongesso /  
frame for recessed mounting  
620x620

**42539**  
accessorio soffitto H mm. 43 /  
ceiling accessory H mm. 43

**11622/2**  
accessorio sospensione H mt. 2 /  
suspension accessory H mt. 2



| CODICE / CODE                  | 41649                     | 41650                     |
|--------------------------------|---------------------------|---------------------------|
| BEAM                           | 110°                      | 110°                      |
| COLORE / COLOUR                | bianco/white              | bianco/white              |
| COLORE LUCE / COLOR T          | 3000K                     | 4000K                     |
| LUMEN                          | 3600                      | 4000                      |
| CRI                            | >80                       | >80                       |
| LED                            | SMD 4014                  | SMD 4014                  |
| WATT                           | 40W                       | 40W                       |
| SUPPLY                         | 230V 50/60Hz              | 230V 50/60Hz              |
| DRIVER                         | 950mA/27-42V flicker-free | 950mA/27-42V flicker-free |
| KG                             | 2,1                       | 2,1                       |
| PCS                            | 5                         | 5                         |
| <b>DIMENSIONI / DIMENSIONS</b> |                           |                           |
| a                              | 595                       | 595                       |
| b                              | 9                         | 9                         |

| ACCESSORI   | 42683 | Driver ONE4ALL 220-240V 12-42V 650-1110mA Dali, Push, 1-10V | listino prezzi Logica/Logica pricelist |
|-------------|-------|---|--|
| ACCESSORIES | 40314 | Driver 110-277V 14-42V 400-1100mA 1-10V                     |  |
|             | 12551 | Emergenza/Emergency 30% - 90min MAX 40W                     | listino prezzi Logica/Logica pricelist |

# PANNELLO LED 60x60 UGR<19



Apparecchio da incasso/soffitto/  
sospensione LED integrato  
Corpo in alluminio verniciato  
LGP in PMMA  
Diffusore in PS  
Driver incluso

Recessed/ceiling/suspension fitting  
with built-in LED  
Painted aluminium body  
PMMA LGP  
PS Diffuser  
Driver included

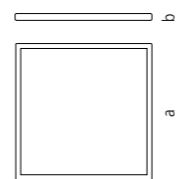

**42538**  
cornice per montaggio cartongesso /  
frame for recessed mounting  
620x620

**42539**  
accessorio soffitto H mm. 43 /  
ceiling accessory H mm. 43

**11622/2**  
accessorio sospensione H mt. 2 /  
suspension accessory H mt. 2



| CODICE / CODE                  | 41653                     | 41654                     |
|--------------------------------|---------------------------|---------------------------|
| BEAM                           | 110°                      | 110°                      |
| COLORE / COLOUR                | bianco/white              | bianco/white              |
| COLORE LUCE / COLOR T          | 3000K                     | 4000K                     |
| LUMEN                          | 3600                      | 4000                      |
| CRI                            | >80                       | >80                       |
| LED                            | SMD 4014                  | SMD 4014                  |
| WATT                           | 40W                       | 40W                       |
| SUPPLY                         | 230V 50/60Hz              | 230V 50/60Hz              |
| DRIVER                         | 950mA/27-42V flicker-free | 950mA/27-42V flicker-free |
| KG                             | 2,1                       | 2,1                       |
| PCS                            | 5                         | 5                         |
| <b>DIMENSIONI / DIMENSIONS</b> |                           |                           |
| a                              | 595                       | 595                       |
| b                              | 9                         | 9                         |

| ACCESSORI   | 42683 | Driver ONE4ALL 220-240V 12-42V 650-1110mA Dali, Push, 1-10V | listino prezzi Logica/Logica pricelist |
|-------------|-------|---|--|
| ACCESSORIES | 40314 | Driver 110-277V 14-42V 400-1100mA 1-10V                     |  |
|             | 12551 | Emergenza/Emergency 30% - 90min MAX 40W                     | listino prezzi Logica/Logica pricelist |

# PANNELLO\_LED 30x120



Apparecchio da incasso/  
soffitto/sospensione LED integrato  
Corpo in alluminio verniciato  
LGP in PMMA  
Diffusore in PS  
Driver incluso

Recessed/ceiling/suspension fitting  
with built-in LED  
Painted aluminium body  
PMMA LGP  
PS Diffuser  
Driver included

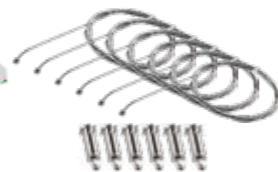
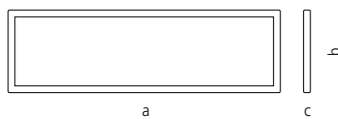

**42542**  
cornice per montaggio cartongesso /  
frame for recessed mounting  
320x1220

**42540**  
accessorio soffitto H mm 43 /  
ceiling accessory H mm 43

**11622/3**  
accessorio sospensione H mt. 2 /  
suspension accessory H mt. 2



| CODICE / CODE                  | 41651                     | 41652                     |
|--------------------------------|---------------------------|---------------------------|
| COLORE / COLOUR                | bianco/white              | bianco/white              |
| COLORE LUCE / COLOR T          | 3000K                     | 4000K                     |
| LUMEN                          | 3600                      | 4000                      |
| CRI                            | >80                       | >80                       |
| LED                            | SMD 4014                  | SMD 4014                  |
| WATT                           | 40W                       | 40W                       |
| SUPPLY                         | 230V 50/60Hz              | 230V 50/60Hz              |
| DRIVER                         | 950mA/27-42V flicker-free | 950mA/27-42V flicker-free |
| KG                             | 2,4                       | 2,4                       |
| PCS                            | 5                         | 5                         |
| <b>DIMENSIONI / DIMENSIONS</b> |                           |                           |
| a                              | 1195                      | 1195                      |
| b                              | 295                       | 295                       |
| c                              | 9                         | 9                         |

| ACCESSORI   | 42683 | Driver ONE4ALL 220-240V 12-42V 650-1110mA Dali, Push, 1-10V | listino prezzi Logica/Logica pricelist |
|-------------|-------|---|--|
| ACCESSORIES | 40314 | Driver 110-277V 14-42V 400-1100mA 1-10V                     |  |
|             | 12551 | Emergenza/Emergency 30% - 90min MAX 40W                     | listino prezzi Logica/Logica pricelist |

# PANNELLO\_LED 30x120 UGR<19



Apparecchio da incasso/  
soffitto/sospensione LED integrato  
Corpo in alluminio verniciato  
LGP in PMMA  
Diffusore in PS  
Driver incluso

Recessed/ceiling/suspension fitting  
with built-in LED  
Painted aluminium body  
PMMA LGP  
PS Diffuser  
Driver included

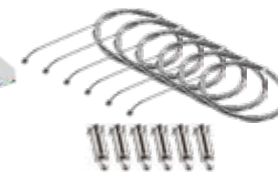
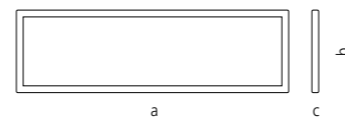

**42542**  
cornice per montaggio cartongesso /  
frame for recessed mounting  
320x1220

**42540**  
accessorio soffitto H mm 43 /  
ceiling accessory H mm 43

**11622/3**  
accessorio sospensione H mt. 2 /  
suspension accessory H mt. 2



| CODICE / CODE                  | 41655                     | 41656                     |
|--------------------------------|---------------------------|---------------------------|
| COLORE / COLOUR                | bianco/white              | bianco/white              |
| COLORE LUCE / COLOR T          | 3000K                     | 4000K                     |
| LUMEN                          | 3600                      | 4000                      |
| CRI                            | >80                       | >80                       |
| LED                            | SMD 4014                  | SMD 4014                  |
| WATT                           | 40W                       | 40W                       |
| SUPPLY                         | 230V 50/60Hz              | 230V 50/60Hz              |
| DRIVER                         | 950mA/27-42V flicker-free | 950mA/27-42V flicker-free |
| KG                             | 2,4                       | 2,4                       |
| PCS                            | 5                         | 5                         |
| <b>DIMENSIONI / DIMENSIONS</b> |                           |                           |
| a                              | 1195                      | 1195                      |
| b                              | 295                       | 295                       |
| c                              | 9                         | 9                         |

| ACCESSORI   | 42683 | Driver ONE4ALL 220-240V 12-42V 650-1110mA Dali, Push, 1-10V | listino prezzi Logica/Logica pricelist |
|-------------|-------|---|--|
| ACCESSORIES | 40314 | Driver 110-277V 14-42V 400-1100mA 1-10V                     |  |
|             | 12551 | Emergenza/Emergency 30% - 90min MAX 40W                     | listino prezzi Logica/Logica pricelist |

# PANNELLO BACKLITE



Apparecchio da incasso  
Corpo in alluminio verniciato  
Diffusore in PS  
Driver incluso

Recessed  
Painted aluminium body  
PS diffuser  
Driver included

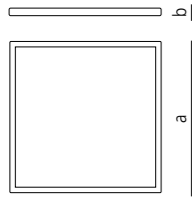

|                                |                           |
|--------------------------------|---------------------------|
| <b>CODICE / CODE</b>           | 41657                     |
| <b>BEAM</b>                    | 110°                      |
| <b>COLORE / COLOUR</b>         | bianco/white              |
| <b>COLORE LUCE / COLOR T</b>   | 4000K                     |
| <b>LUMEN</b>                   | 3200                      |
| <b>CRI</b>                     | >80                       |
| <b>LED</b>                     | SMD 4014                  |
| <b>WATT</b>                    | 40W                       |
| <b>SUPPLY</b>                  | 230V 50/60Hz              |
| <b>DRIVER</b>                  | 950mA/27-42V flicker-free |
| <b>KG</b>                      | 1,5                       |
| <b>PCS</b>                     | 2/6                       |
| <b>DIMENSIONI / DIMENSIONS</b> |                           |
| <b>a</b>                       | 595                       |
| <b>b</b>                       | 30                        |

|                    |  |  |
|--------------------|--|--|
| <b>ACCESSORI</b>   | <b>42683</b> Driver ONE4ALL 220-240V 12-42V 650-1110mA Dali, Push, 1-10V | listino prezzi Logica/Logica pricelist |
| <b>ACCESSORIES</b> | <b>40314</b> Driver 110-277V 14-42V 400-1100mA 1-10V                     |  |
|                    | <b>12551</b> Emergenza/Emergency 30% - 90min MAX 40W                     | listino prezzi Logica/Logica pricelist |



**INCASSI**  
INTERNO

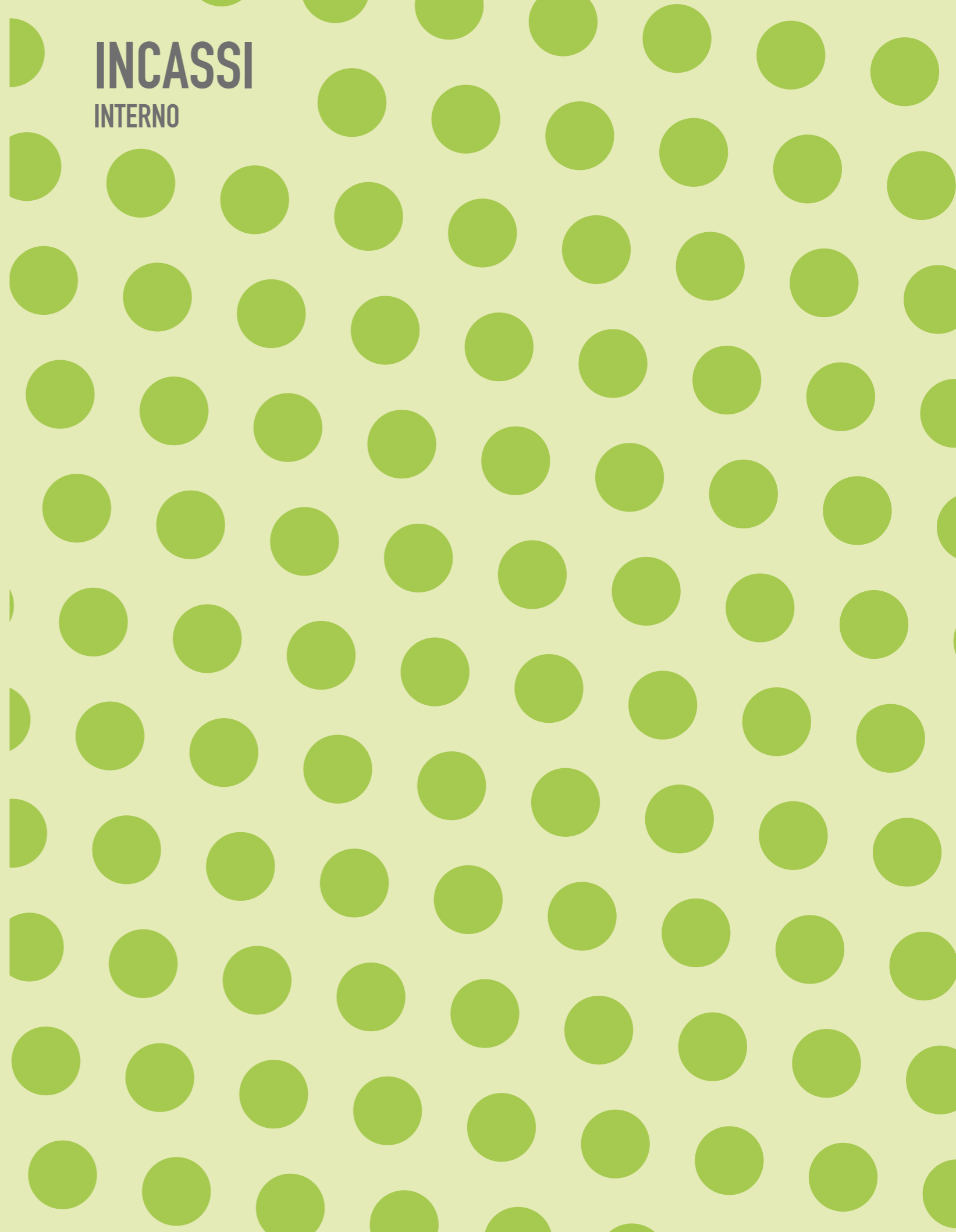



# ERCOLE



Incasso LED integrato  
Corpo in alluminio  
Diffusore in PC opale  
Driver incluso

Recessed fitting with built-in LED  
Aluminium body  
Opal PC diffuser  
Driver included

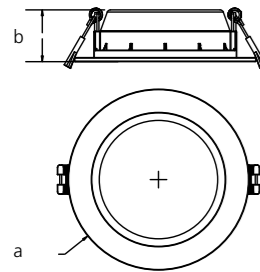

| CODICE / CODE           | 41253            | 41254            |
|-------------------------|------------------|------------------|
| BEAM                    | 90°              | 90°              |
| COLORE / COLOUR         | bianco/white     | bianco/white     |
| COLORE LUCE / COLOR T   | 3000K            | 4000K            |
| LUMEN                   | 1980             | 2090             |
| CRI                     | 80               | 80               |
| LED                     | EPISTAR          | EPISTAR          |
| WATT                    | 22W              | 22W              |
| SUPPLY                  | 220-240V         | 220-240V         |
| DRIVER                  | 50.4-59.4V/350mA | 50.4-59.4V/350mA |
| KG                      | 0,55             | 0,55             |
| PCS                     |                  |                  |
| DIMENSIONI / DIMENSIONS |                  |                  |
| a                       | 230              | 230              |
| b                       | 65,5             | 65,5             |
| cut size                | 200              | 200              |

# ERCOLE IP54



Incasso LED integrato  
Corpo in alluminio pressofuso  
Diffusore in PC opale  
Riflettore cromato  
Driver incluso

Recessed fitting with built-in LED  
Die-cast aluminium body  
Opal PC diffuser  
Driver included

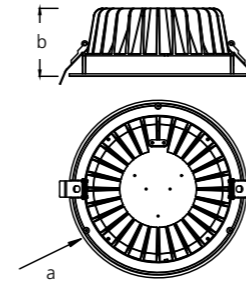

| CODICE / CODE           | 41255            | 41256            |
|-------------------------|------------------|------------------|
| BEAM                    | 90°              | 90°              |
| COLORE / COLOUR         | bianco/white     | bianco/white     |
| COLORE LUCE / COLOR T   | 3000K            | 4000K            |
| LUMEN                   | 1995             | 2110             |
| CRI                     | 80               | 80               |
| LED                     | EPISTAR          | EPISTAR          |
| WATT                    | 23W              | 23W              |
| SUPPLY                  | 220-240V         | 220-240V         |
| DRIVER                  | 50.4-59.4V/350mA | 50.4-59.4V/350mA |
| KG                      | 1,22             | 1,22             |
| PCS                     |                  |                  |
| DIMENSIONI / DIMENSIONS |                  |                  |
| a                       | 230              | 230              |
| b                       | 88               | 88               |
| cut size                | 200              | 200              |

# VULCANO\_EVO



Incasso LED integrato  
Corpo in TRP  
Diffusore in PC opale  
Riflettore cromato  
Driver integrato

Recessed fitting with built-in LED  
TRP body  
Opal PC diffuser  
Chromed reflector  
Built-in driver



| CODICE / CODE           | 40571               | 40572               | 40573               | 40574               | 40575               | 40576               | 40577               | 40578               |
|-------------------------|---------------------|---------------------|---------------------|---------------------|---------------------|---------------------|---------------------|---------------------|
| BEAM                    | 80°                 | 75°                 | 65°                 | 65°                 | 80°                 | 75°                 | 65°                 | 65°                 |
| COLORE / COLOUR         | bianco<br>white     | bianco<br>white     | bianco<br>white     | bianco<br>white     | bianco<br>white     | bianco<br>white     | bianco<br>white     | bianco<br>white     |
| COLORE LUCE / COLOR T   | 3000K               | 3000K               | 3000K               | 3000K               | 4000K               | 4000K               | 4000K               | 4000K               |
| LUMEN                   | 1000                | 1400                | 1600                | 1900                | 1100                | 1500                | 1700                | 2000                |
| CRI                     | >80                 | >80                 | >80                 | >80                 | >80                 | >80                 | >80                 | >80                 |
| LED                     | Everlight           | Everlight           | Everlight           | Everlight           | Everlight           | Everlight           | Everlight           | Everlight           |
| WATT                    | 15W                 | 20W                 | 25W                 | 30W                 | 15W                 | 20W                 | 25W                 | 30W                 |
| PF                      | >0,5                | >0,5                | >0,9                | >0,9                | >0,5                | >0,5                | >0,9                | >0,9                |
| SUPPLY                  | 220-240V<br>50/60Hz | 220-240V<br>50/60Hz | 220-240V<br>50/60Hz | 220-240V<br>50/60Hz | 220-240V<br>50/60Hz | 220-240V<br>50/60Hz | 220-240V<br>50/60Hz | 220-240V<br>50/60Hz |
| KG                      | 0,25                | 0,35                | 0,47                | 0,47                | 0,25                | 0,35                | 0,47                | 0,47                |
| DRIVER                  | 140mA/90V           | 160mA/108V          | 160mA/135V          | 240mA/108V          | 140mA/90V           | 160mA/108V          | 160mA/135V          | 240mA/108V          |
| FORO / HOLE             | Ø125                | Ø160                | Ø200                | Ø200                | Ø125                | Ø160                | Ø200                | Ø200                |
| PCS                     | 40                  | 20                  | 20                  | 20                  | 40                  | 20                  | 20                  | 20                  |
| DIMENSIONI / DIMENSIONS |                     |                     |                     |                     |                     |                     |                     |                     |
| a                       | 150                 | 190                 | 230                 | 230                 | 150                 | 190                 | 230                 | 230                 |
| b                       | 81                  | 91                  | 101,5               | 101,5               | 81                  | 91                  | 101,5               | 101,5               |

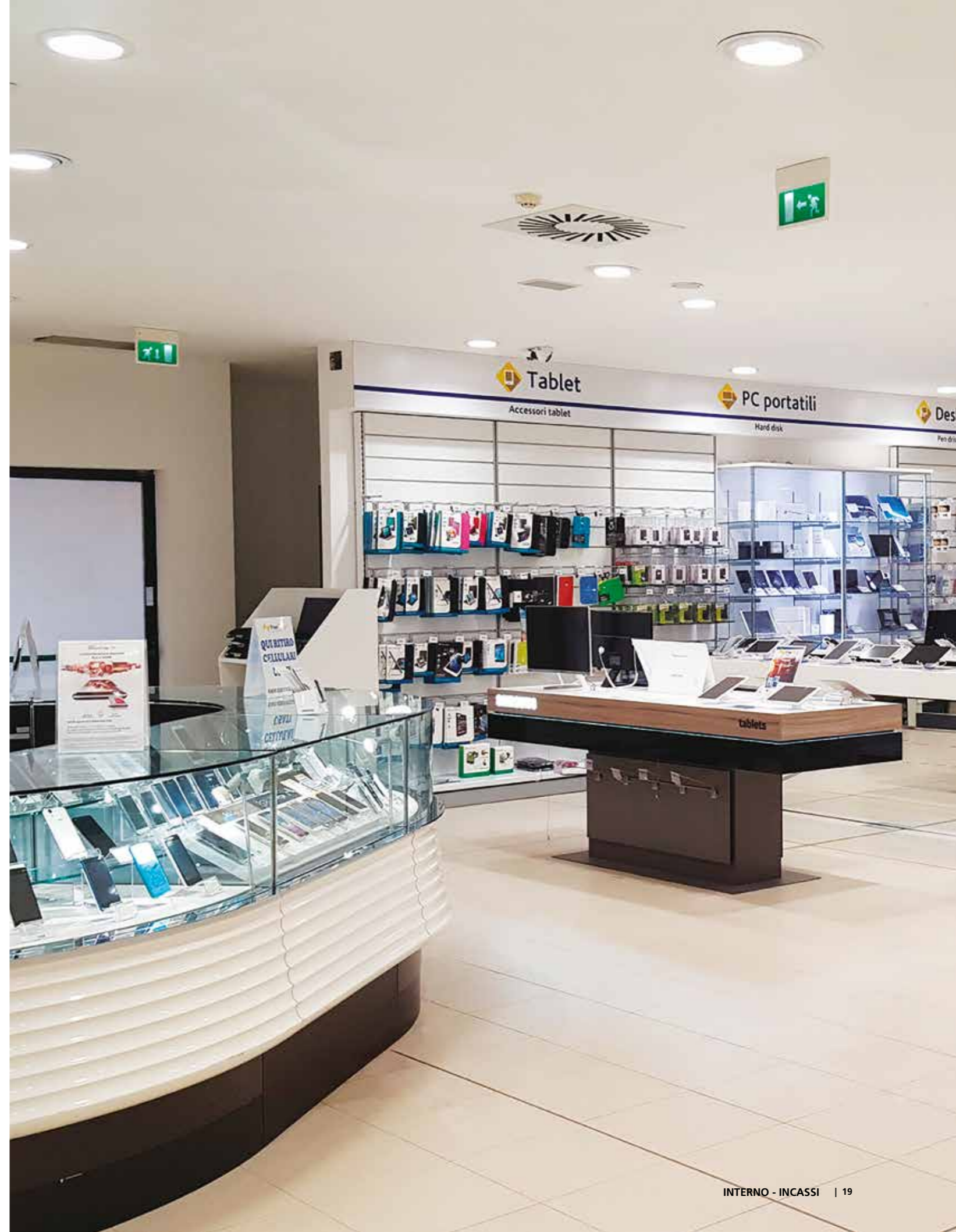

# LEDSPOT\_TRP1



Incasso LED integrato  
Corpo in TRP  
Diffusore in PC opale  
Driver integrato

Recessed fitting with built-in LED  
TRP body  
Opal PC diffuser  
Built-in driver



| CODICE / CODE           | 40511           | 40512           | 40513           | 40514           | 40515           | 40516           | 40517           | 40518           |
|-------------------------|-----------------|-----------------|-----------------|-----------------|-----------------|-----------------|-----------------|-----------------|
| COLORE / COLOUR         | bianco<br>white | bianco<br>white | bianco<br>white | bianco<br>white | bianco<br>white | bianco<br>white | bianco<br>white | bianco<br>white |
| COLORE LUCE / COLOR T   | 3000K           | 4000K           | 3000K           | 4000K           | 3000K           | 4000K           | 3000K           | 4000K           |
| LUMEN                   | 825             | 888             | 1242            | 1320            | 2135            | 2332            | 2431            | 2487            |
| CRI                     | >80             | >80             | >80             | >80             | >80             | >80             | >80             | >80             |
| LED                     | Epistar         | Epistar         | Epistar         | Epistar         | Epistar         | Epistar         | Epistar         | Epistar         |
| WATT                    | 10W             | 10W             | 15W             | 15W             | 25W             | 25W             | 30W             | 30W             |
| PF                      | >0,5            | >0,5            | >0,5            | >0,5            | >0,5            | >0,5            | >0,9            | >0,9            |
| SUPPLY                  | 230V<br>50/60Hz | 230V<br>50/60Hz | 230V<br>50/60Hz | 230V<br>50/60Hz | 230V<br>50/60Hz | 230V<br>50/60Hz | 230V<br>50/60Hz | 230V<br>50/60Hz |
| FORO / HOLE             | Ø90             | Ø90             | Ø120            | Ø120            | Ø170            | Ø170            | Ø200            | Ø200            |
| KG                      | 0,14            | 0,14            | 0,20            | 0,20            | 0,33            | 0,33            | 0,45            | 0,45            |
| PCS                     | 20              | 20              | 20              | 20              | 20              | 20              | 20              | 20              |
| DIMENSIONI / DIMENSIONS |                 |                 |                 |                 |                 |                 |                 |                 |
| a                       | 120             | 120             | 150             | 150             | 200             | 200             | 230             | 230             |
| b                       | 60              | 60              | 60              | 60              | 60              | 60              | 60              | 60              |



# QUADRO\_30



Incasso LED integrato  
Corpo in TRP  
Diffusore PC opale  
Driver integrato

Recessed fitting with built-in LED  
TRP body  
Opal PC diffuser  
Built-in driver

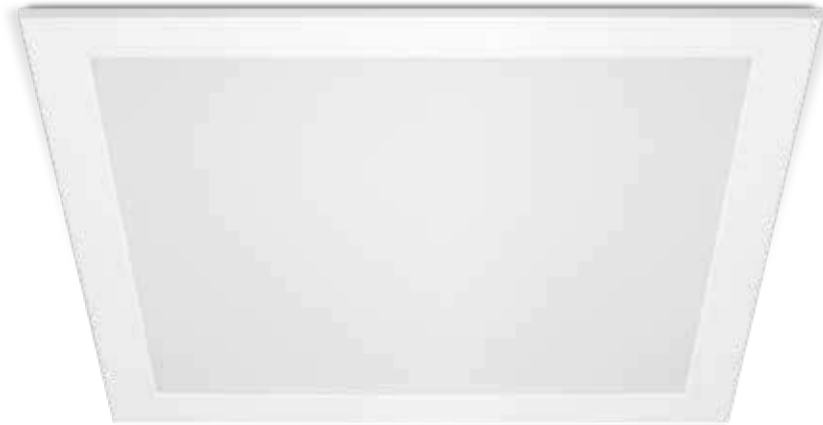

| CODICE / CODE                  | 40752            | 40753            |
|--------------------------------|------------------|------------------|
| BEAM                           | 111°             | 111°             |
| COLORE / COLOUR                | bianco<br>white  | bianco<br>white  |
| COLORE LUCE / COLOR T          | 3000K            | 4000K            |
| LUMEN                          | 2400             | 2500             |
| CRI                            | >80              | >80              |
| LED                            | Everlight        | Everlight        |
| WATT                           | 30W              | 30W              |
| PF                             | >0.9             | >0.9             |
| SUPPLY                         | 220-240V 50/60Hz | 220-240V 50/60Hz |
| KG                             | 0.78             | 0.78             |
| FORO / HOLE                    | 288x288          | 288x288          |
| PCS                            | 20               | 20               |
| <b>DIMENSIONI / DIMENSIONS</b> |                  |                  |
| <b>a</b>                       | 300x300          | 300x300          |
| <b>b</b>                       | 65               | 65               |



# DIN



Incasso LED integrato  
Corpo in pressofusione di alluminio verniciato  
Schermo in PC trasparente  
Driver incluso

Recessed fitting with built-in LED  
Painted die-cast aluminium body  
Transparent PC screen  
Driver included

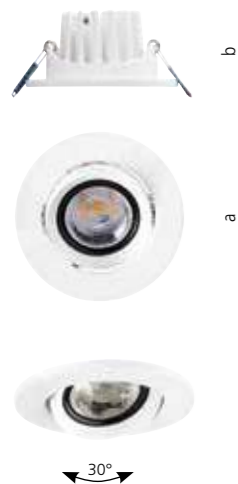

|                                |              |
|--------------------------------|--------------|
| <b>CODICE / CODE</b>           | 40210        |
| <b>BEAM</b>                    | 38°          |
| <b>COLORE / COLOUR</b>         | bianco/white |
| <b>COLORE LUCE / COLOR T</b>   | 3000K        |
| <b>LUMEN</b>                   | 550          |
| <b>CRI</b>                     | >80          |
| <b>LED</b>                     | Refong COB   |
| <b>WATT</b>                    | 9W           |
| <b>PF</b>                      | >0,5         |
| <b>SUPPLY</b>                  | 230V 50/60Hz |
| <b>DRIVER</b>                  | 108mA/15-30V |
| <b>FORO / HOLE</b>             | Ø75          |
| <b>KG</b>                      | 0,14         |
| <b>PCS</b>                     | 10           |
| <b>DIMENSIONI / DIMENSIONS</b> |              |
| <b>a</b>                       | 85           |
| <b>b</b>                       | 42           |

# DON



Incasso LED integrato  
Corpo in pressofusione di alluminio verniciato  
Schermo in PC trasparente  
Driver incluso

Recessed fitting with built-in LED  
Painted die-cast aluminium body  
Transparent PC screen  
Driver included

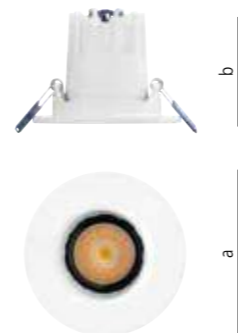

|                                |              |
|--------------------------------|--------------|
| <b>CODICE / CODE</b>           | 40211        |
| <b>BEAM</b>                    | 25°          |
| <b>COLORE / COLOUR</b>         | bianco/white |
| <b>COLORE LUCE / COLOR T</b>   | 3000K        |
| <b>LUMEN</b>                   | 550          |
| <b>CRI</b>                     | >80          |
| <b>LED</b>                     | Refong COB   |
| <b>WATT</b>                    | 9W           |
| <b>PF</b>                      | >0,5         |
| <b>SUPPLY</b>                  | 230V 50/60Hz |
| <b>DRIVER</b>                  | 108mA/15-30V |
| <b>FORO / HOLE</b>             | Ø75          |
| <b>KG</b>                      | 0,14         |
| <b>PCS</b>                     | 10           |
| <b>DIMENSIONI / DIMENSIONS</b> |              |
| <b>a</b>                       | 85           |
| <b>b</b>                       | 65           |



# SPLASH



Incasso GU5,3  
 Corpo in pressofusione di alluminio verniciato  
 Schermo in vetro trasparente

Recessed fitting GU5,3  
 Painted die-cast aluminium body  
 Transparent glass screen



|                                |                |                |
|--------------------------------|----------------|----------------|
| <b>CODICE / CODE</b>           | <b>40326</b>   | <b>40327</b>   |
| <b>COLORE / COLOUR</b>         | bianco / white | cromo / chrome |
| <b>LAMP</b>                    | GU5,3          | GU5,3          |
| <b>WATT</b>                    | Max 35W        | Max 35W        |
| <b>SUPPLY</b>                  | 12V            | 12V            |
| <b>FORO / HOLE</b>             | Ø72            | Ø72            |
| <b>KG</b>                      | 0,14           | 0,14           |
| <b>PCS</b>                     | 50             | 50             |
| <b>DIMENSIONI / DIMENSIONS</b> |                |                |
| <b>a</b>                       | 82             | 82             |
| <b>b</b>                       | 36             | 36             |

# HELIOS\_50



Incasso  
Corpo in pressofusione di alluminio

Recessed fitting  
Painted die-cast aluminium body



| CODICE / CODE           | 41243           | 41244         | 41246       | 41245           | 41247                    |
|-------------------------|-----------------|---------------|-------------|-----------------|--------------------------|
| COLORE / COLOUR         | bianco<br>white | nero<br>black | oro<br>gold | cromo<br>chrome | nikel matt<br>nikel matt |
| LAMP                    | GU10            | GU10          | GU10        | GU10            | GU10                     |
| WATT                    | Max 50W         | Max 50W       | Max 50W     | Max 50W         | Max 50W                  |
| SUPPLY                  | 230V            | 230V          | 230V        | 230V            | 230V                     |
| FORO / HOLE             | Ø60             | Ø60           | Ø60         | Ø60             | Ø60                      |
| KG                      | 0,1             | 0,1           | 0,1         | 0,1             | 0,1                      |
| PCS                     | 100             | 100           | 100         | 100             | 100                      |
| DIMENSIONI / DIMENSIONS |                 |               |             |                 |                          |
| a                       | 80              | 80            | 80          | 80              | 80                       |
| b                       | 23              | 23            | 23          | 23              | 23                       |

# HELIOS\_50



Incasso orientabile  
Corpo in pressofusione di alluminio

Adjustable recessed fitting  
Painted die-cast aluminium body

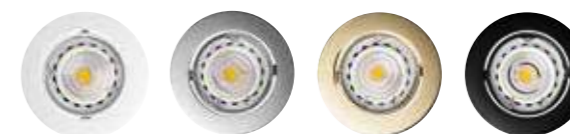

| CODICE / CODE           | 41248           | 41249         | 41251       | 41250           | 41252                    |
|-------------------------|-----------------|---------------|-------------|-----------------|--------------------------|
| COLORE / COLOUR         | bianco<br>white | nero<br>black | oro<br>gold | cromo<br>chrome | nikel matt<br>nikel matt |
| LAMP                    | GU10            | GU10          | GU10        | GU10            | GU10                     |
| WATT                    | Max 50W         | Max 50W       | Max 50W     | Max 50W         | Max 50W                  |
| SUPPLY                  | 230V            | 230V          | 230V        | 230V            | 230V                     |
| FORO / HOLE             | Ø70             | Ø70           | Ø70         | Ø70             | Ø70                      |
| KG                      | 0,1             | 0,1           | 0,1         | 0,1             | 0,1                      |
| PCS                     | 100             | 100           | 100         | 100             | 100                      |
| DIMENSIONI / DIMENSIONS |                 |               |             |                 |                          |
| a                       | 80              | 80            | 80          | 80              | 80                       |
| b                       | 23              | 23            | 23          | 23              | 23                       |

# SOFFITTO / PARETE

INTERNO





# PLAFOLED T

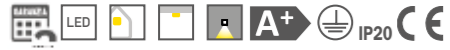

Apparecchio da soffitto LED integrato  
Corpo in metallo verniciato  
Diffusore in MS  
Driver incluso

Ceiling fitting Painted metal body  
MS diffuser  
Driver included

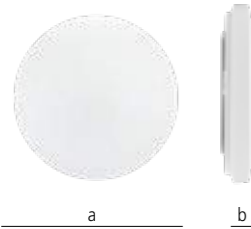
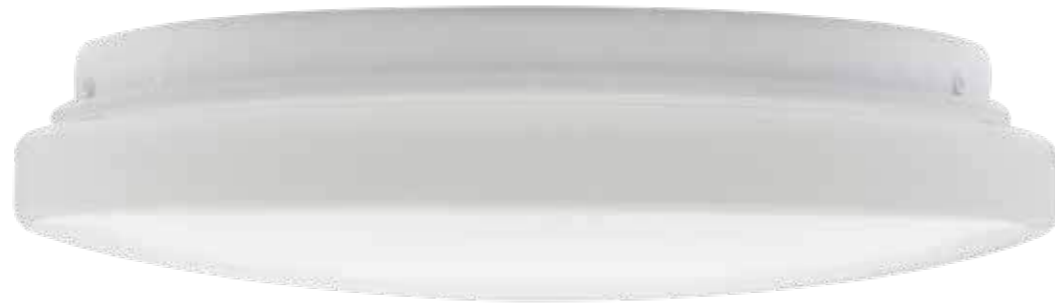

# PLAFOLED Q



Apparecchio da soffitto LED integrato  
Corpo in metallo verniciato  
Diffusore in MS  
Driver incluso

Ceiling fitting Painted metal body  
MS diffuser  
Driver included

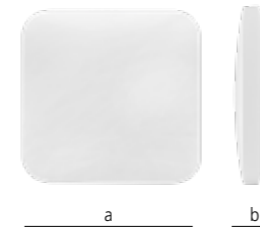

| CODICE/CODE           | 41006             | 41007             | 41008             | 41009             | 41010             | 41011             |
|-----------------------|-------------------|-------------------|-------------------|-------------------|-------------------|-------------------|
| BEAM                  | 130°              | 130°              | 130°              | 130°              | 130°              | 130°              |
| COLORE/COLOUR         | bianco/white      | bianco/white      | bianco/white      | bianco/white      | bianco/white      | bianco/white      |
| COLORE/COLOUR T       | 3000K             | 4000K             | 3000K             | 4000K             | 3000K             | 4000K             |
| LUMEN                 | 1820              | 1900              | 2430              | 2500              | 3180              | 3190              |
| CRI                   | >80               | >80               | >80               | >80               | >80               | >80               |
| LED                   | NationStar        | NationStar        | NationStar        | NationStar        | NationStar        | NationStar        |
| WATT                  | 24W               | 24W               | 32W               | 32W               | 42W               | 42W               |
| PF                    | 0,5               | 0,5               | 0,9               | 0,9               | 0,9               | 0,9               |
| SUPPLY                | 220-240V, 50/60Hz | 220-240V, 50/60Hz | 220-240V, 50/60Hz | 220-240V, 50/60Hz | 220-240V, 50/60Hz | 220-240V, 50/60Hz |
| DRIVER                | 210mA/115-200V    | 210mA/115-200V    | 80mA/432-500V     | 80mA/432-500V     | 370mA/115-160V    | 370mA/115-160V    |
| KG                    | 0.6KG             | 0.6KG             | 0.7KG             | 0.7KG             | 1KG               | 1KG               |
| PCS                   | 10                | 10                | 10                | 10                | 10                | 10                |
| DIMENSIONI/DIMENSIONS |                   |                   |                   |                   |                   |                   |
| a                     | Ø340              | Ø340              | Ø390              | Ø390              | Ø480              | Ø480              |
| b                     | 65                | 65                | 65                | 65                | 78                | 78                |

| CODICE/CODE           | 41012             | 41013             | 41014             | 41015             |
|-----------------------|-------------------|-------------------|-------------------|-------------------|
| BEAM                  | 120°              | 120°              | 120°              | 120°              |
| COLORE/COLOUR         | bianco/white      | bianco/white      | bianco/white      | bianco/white      |
| COLORE/COLOUR T       | 3000K             | 4000K             | 3000K             | 4000K             |
| LUMEN                 | 2560              | 2660              | 3180              | 3300              |
| CRI                   | >80               | >80               | >80               | >80               |
| LED                   | NationStar        | NationStar        | NationStar        | NationStar        |
| WATT                  | 32W               | 32W               | 42W               | 42W               |
| PF                    | 0,5               | 0,5               | 0,9               | 0,9               |
| SUPPLY                | 220-240V, 50/60Hz | 220-240V, 50/60Hz | 220-240V, 50/60Hz | 220-240V, 50/60Hz |
| DRIVER                | 80mA/432-500V     | 80mA/432-500V     | 370mA/115-160V    | 370mA/115-160V    |
| KG                    | 0.7KG             | 0.7KG             | 1KG               | 1KG               |
| PCS                   | 10                | 10                | 5                 | 5                 |
| DIMENSIONI/DIMENSIONS |                   |                   |                   |                   |
| a                     | 330               | 330               | 430               | 430               |
| b                     | 65                | 65                | 65                | 65                |

# HYDRA T



Apparecchio a soffitto  
Anello in alluminio  
Schermo in PC opale

Ceiling fitting  
Aluminium ring  
Opal PC screen

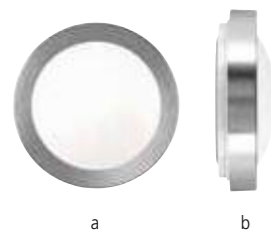

| CODICE / CODE                  | 43439        | 40439               | 43440        | 40440               |
|--------------------------------|--------------|---------------------|--------------|---------------------|
| COLORE / COLOUR                | bianco/white | alluminio/aluminium | bianco/white | alluminio/aluminium |
| LAMP                           | E27          | E27                 | E27          | E27                 |
| WATT                           | Max 20W      | Max 20W             | Max 2x20W    | Max 2x20W           |
| SUPPLY                         | 230V 50/60Hz | 230V 50/60Hz        | 230V 50/60Hz | 230V 50/60Hz        |
| KG                             | 0,48         | 0,48                | 0,48         | 0,48                |
| PCS                            | 10           | 10                  | 10           | 10                  |
| <b>DIMENSIONI / DIMENSIONS</b> |              |                     |              |                     |
| <b>a</b>                       | 270          | 270                 | 350          | 350                 |
| <b>b</b>                       | 97           | 97                  | 97           | 97                  |

# HYDRA Q



Apparecchio a soffitto  
Anello in alluminio  
Schermo in PC opale

Ceiling fitting  
Aluminium ring  
Opal PC screen

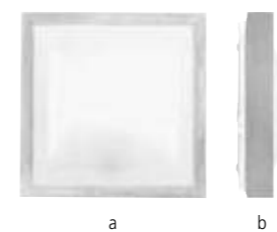
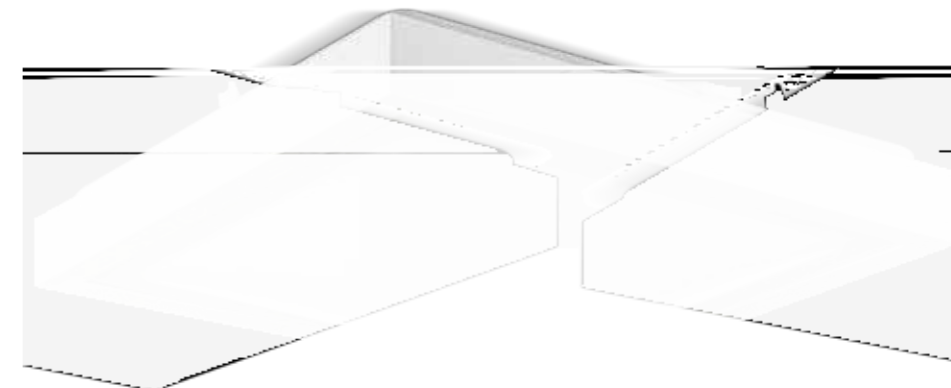

| CODICE / CODE                  | 43441        | 40441               | 43442        | 40442               |
|--------------------------------|--------------|---------------------|--------------|---------------------|
| COLORE / COLOUR                | bianco/white | alluminio/aluminium | bianco/white | alluminio/aluminium |
| LAMP                           | E27          | E27                 | E27          | E27                 |
| WATT                           | Max 20W      | Max 20W             | Max 3x20W    | Max 3x20W           |
| SUPPLY                         | 230V 50/60Hz | 230V 50/60Hz        | 230V 50/60Hz | 230V 50/60Hz        |
| KG                             | 0,85         | 0,85                | 1,3          | 1,3                 |
| PCS                            | 10           | 10                  | 5            | 5                   |
| <b>DIMENSIONI / DIMENSIONS</b> |              |                     |              |                     |
| <b>a</b>                       | 270          | 270                 | 370          | 370                 |
| <b>b</b>                       | 85           | 85                  | 85           | 85                  |

# PANNELLO TONDO



Apparecchio da soffitto LED integrato  
Corpo in alluminio verniciato  
Diffusore in PMMA  
Driver incluso

Ceiling fitting  
Painted aluminium body  
PMMA diffuser  
Driver included

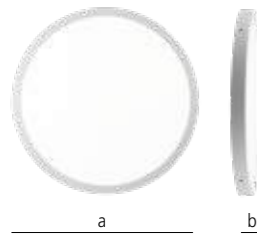

| CODICE / CODE           | 41585         | 41586         |
|-------------------------|---------------|---------------|
| BEAM                    | 120°          | 120°          |
| COLORE / COLOUR         | bianco/white  | bianco/white  |
| COLORE LUCE / COLOR T   | 3000K         | 4000K         |
| LUMEN                   | 4480          | 4889          |
| CRI                     | >80           | >80           |
| LED                     | Epistar       | Epistar       |
| WATT                    | 48W           | 48W           |
| PF                      | 0.9           | 0.9           |
| SUPPLY                  | 230V 50/60Hz  | 230V 50/60Hz  |
| DRIVER                  | 1200mA/30-42V | 1200mA/30-42V |
| KG                      | 3,4           | 3,4           |
| PCS                     | 2             | 2             |
| DIMENSIONI / DIMENSIONS |               |               |
| a                       | Ø600          | Ø600          |
| b                       | 40            | 40            |

# ISIDE



Apparecchio soffitto  
Corpo in acciaio  
Diffusore in PMMA

Ceiling fitting  
Steel body  
PMMA diffuser

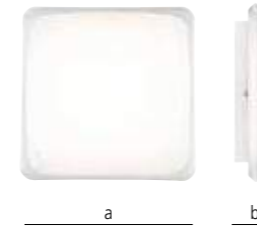

| CODICE / CODE           | 40378        |
|-------------------------|--------------|
| COLORE / COLOUR         | bianco/white |
| COLORE LUCE / COLOR T   | 3000K        |
| LUMEN                   | 4000         |
| CRI                     | >80          |
| LED                     | Sanan        |
| WATT                    | 50W          |
| PF                      | 0.9          |
| SUPPLY                  | 230V 50/60Hz |
| KG                      | 2            |
| PCS                     | 2            |
| DIMENSIONI / DIMENSIONS |              |
| a                       | 510          |
| b                       | 100          |

# MAYA



Apparecchio a soffitto  
Corpo in materiale plastico  
Schermo in PC opale

Ceiling fitting  
Plastic body  
Opal PC screen



| CODICE / CODE           | 40366           | 40365             |
|-------------------------|-----------------|-------------------|
| COLORE / COLOUR         | bianco<br>white | argento<br>silver |
| LAMP                    | E27             | E27               |
| WATT                    | Max 15W         | Max 15W           |
| SUPPLY                  | 230V 50/60Hz    | 230V 50/60Hz      |
| KG                      | 0,4             | 0,4               |
| PCS                     | 10              | 10                |
| DIMENSIONI / DIMENSIONS |                 |                   |
| a                       | Ø270            | Ø270              |
| b                       | 100             | 100               |

# DISCO



Apparecchio a soffitto  
Corpo in metallo  
Schermo in vetro satinato

Ceiling fitting  
Metal body  
Frosted glass screen

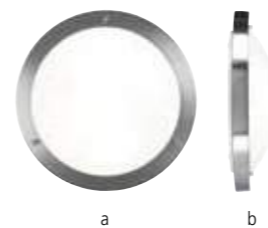

| CODICE / CODE           | 43544           | 41544         | 43545           | 41545         |
|-------------------------|-----------------|---------------|-----------------|---------------|
| COLORE / COLOUR         | bianco<br>white | nikel<br>matt | bianco<br>white | nikel<br>matt |
| LAMP                    | E27             | E27           | E27             | E27           |
| WATT                    | Max 2x28W       | Max 2x28W     | Max 2x52W       | Max 2x52W     |
| SUPPLY                  | 230V 50/60Hz    | 230V 50/60Hz  | 230V 50/60Hz    | 230V 50/60Hz  |
| KG                      | 1,5             | 1,5           | 2,8             | 2,8           |
| PCS                     | 10              | 10            | 5               | 5             |
| DIMENSIONI / DIMENSIONS |                 |               |                 |               |
| a                       | Ø300            | Ø300          | Ø400            | Ø400          |
| b                       | 90              | 90            | 110             | 110           |

# LUCE QUADRO



Apparecchio a parete  
LED integrato  
Corpo in metallo cromato  
Diffusore in PC opale

Built-in LED  
wall fitting  
Chromed metal body  
Opal PC diffuser

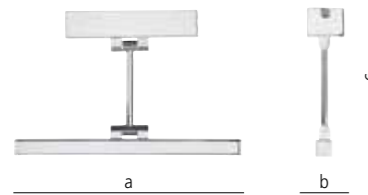
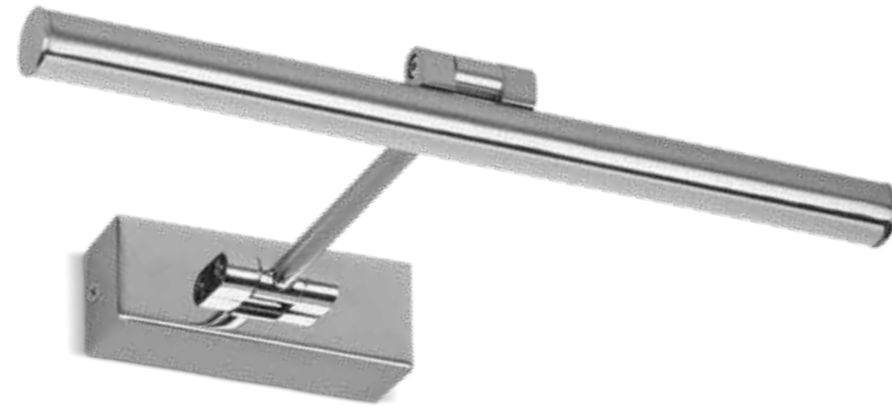

| CODICE / CODE           | 42612           | 42613           | 42614           |
|-------------------------|-----------------|-----------------|-----------------|
| COLORE / COLOUR         | cromo/chrome    | cromo/chrome    | cromo/chrome    |
| COLORE LUCE / COLOR T   | 3000K           | 3000K           | 3000K           |
| LUMEN                   | 500             | 750             | 1000            |
| CRI                     | >80             | >80             | >80             |
| LED                     | Sanan           | Sanan           | Sanan           |
| WATT                    | 8W              | 12W             | 16W             |
| PF                      | >0,5            | >0,5            | >0,5            |
| SUPPLY                  | 220mA<br>18-36V | 350mA<br>24-45V | 350mA<br>24-45V |
| KG                      |                 |                 |                 |
| PCS                     | 12              | 12              | 12              |
| DIMENSIONI / DIMENSIONS |                 |                 |                 |
| a                       | 300             | 450             | 600             |
| b                       | 40              | 45              | 45              |
| c                       | 220             | 225             | 225             |

# LUCE QUADRO



Apparecchio a parete  
LED integrato  
Corpo in metallo cromato  
Diffusore in PC opale

Built-in LED  
wall fitting  
Chromed metal body  
Opal PC diffuser

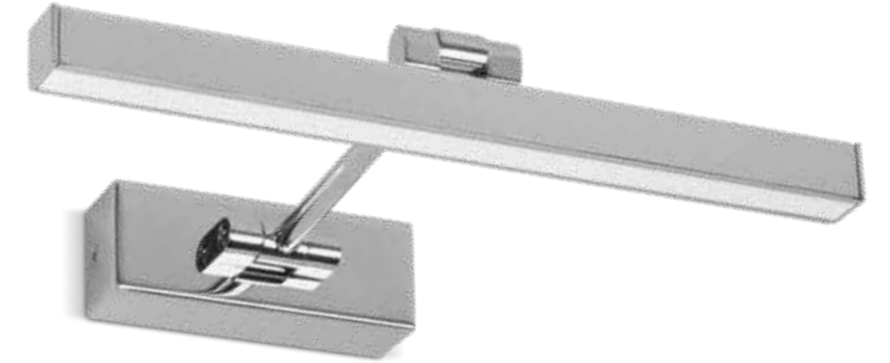

| CODICE / CODE           | 42609           | 42610           | 42611           |
|-------------------------|-----------------|-----------------|-----------------|
| COLORE / COLOUR         | cromo/chrome    | cromo/chrome    | cromo/chrome    |
| COLORE LUCE / COLOR T   | 3000K           | 3000K           | 3000K           |
| LUMEN                   | 500             | 750             | 1000            |
| CRI                     | >80             | >80             | >80             |
| LED                     | Sanan           | Sanan           | Sanan           |
| WATT                    | 8W              | 12W             | 16W             |
| PF                      | >0,5            | >0,5            | >0,5            |
| SUPPLY                  | 220mA<br>18-36V | 350mA<br>24-45V | 350mA<br>24-45V |
| KG                      |                 |                 |                 |
| PCS                     | 12              | 12              | 12              |
| DIMENSIONI / DIMENSIONS |                 |                 |                 |
| a                       | 300             | 450             | 600             |
| b                       | 40              | 45              | 45              |
| c                       | 220             | 225             | 225             |

**INDUSTRIALE**  
INTERNO

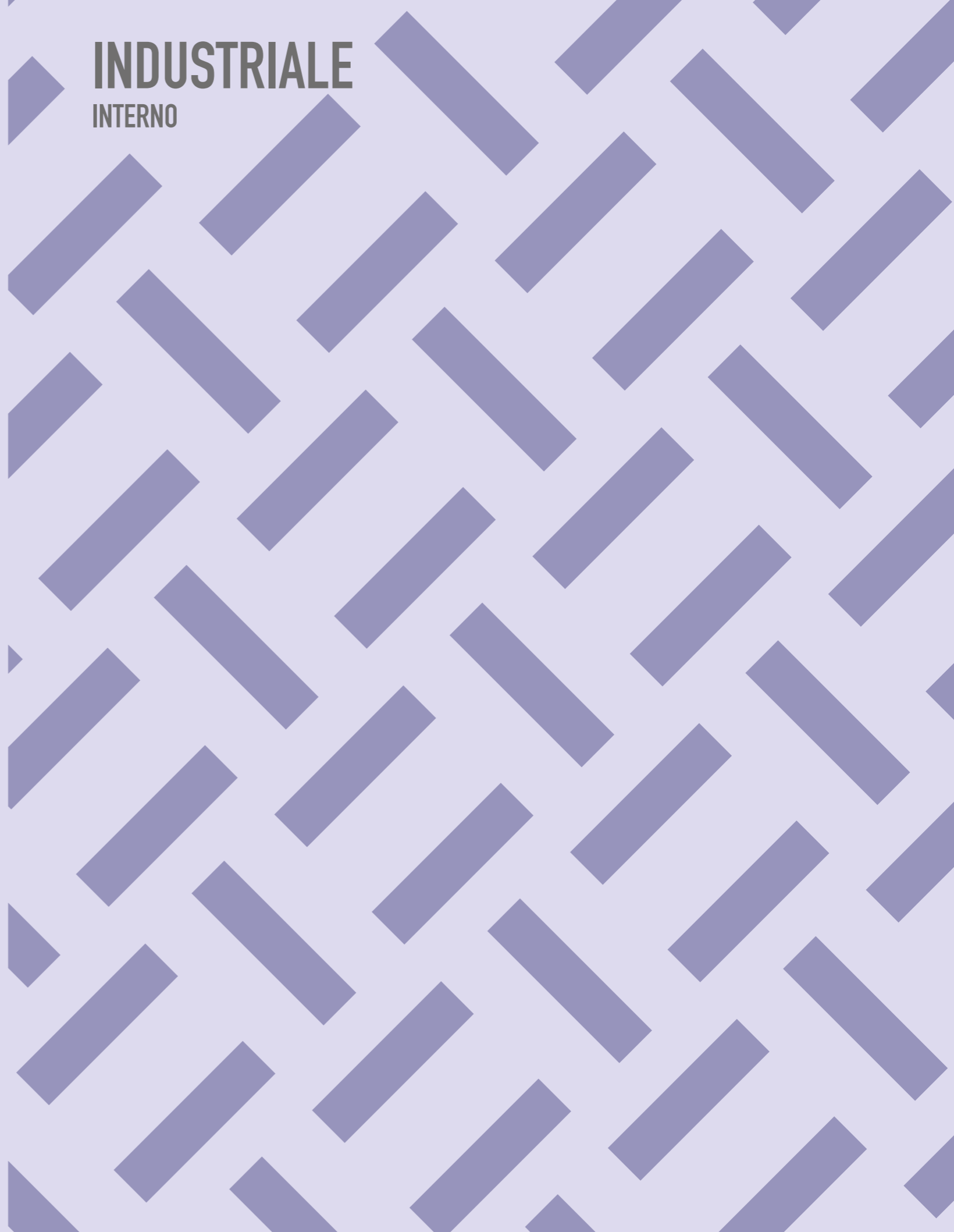

# HORUS



Apparecchio LED integrato  
per installazione a sospensione  
ed a parete con staffa (accessorio)  
Corpo in alluminio  
Led CREE/Driver Meanwell

LED fitting to be suspended or wall  
mounted through relative bracket  
Aluminium body  
CREE Led/Meanwell Driver

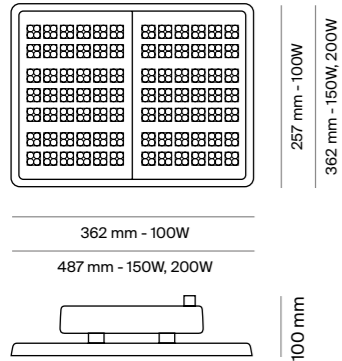

| CODICE / CODE    | 41597            | 41598            | 41599            |
|------------------|------------------|------------------|------------------|
| WATT             | 100W             | 150W             | 200W             |
| LUMEN            | 13000            | 19500            | 26000            |
| ANGOLO           | 80°              | 80°              | 80°              |
| COLORE LUCE      | 4000K            | 4000K            | 4000K            |
| CRI              | >80              | >80              | >80              |
| FINITURA         | nero             | nero             | nero             |
| ALIMENTAZIONE    | 220-240V 50/60Hz | 220-240V 50/60Hz | 220-240V 50/60Hz |
| PF               | >0,9             | >0,9             | >0,9             |
| T° D'ESERCIZIO   | -40°÷70°C        | -40°÷70°C        | -40°÷70°C        |
| KG               | 4,9              | 6,5              | 6,5              |
| VITA UTILE MEDIA | 50000h           | 50000h           | 50000h           |

ACCESSORI  
ACCESSORIES

11555 Staffa/Bracket



# ATON



Apparecchio LED integrato  
per installazione a sospensione  
o su blindosbarra  
Corpo in alluminio estruso  
Led CREE/Driver Meanwell

LED fitting to be suspended  
or mounted on busways  
Extruded aluminium body  
CREE Led/Meanwell Driver

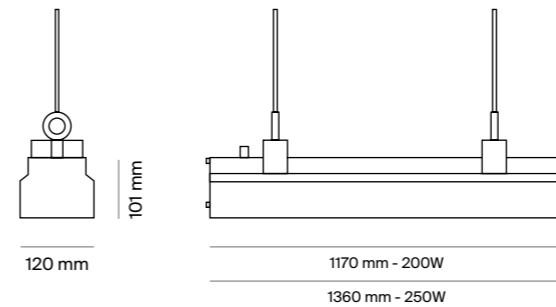

| CODICE / CODE    | 41642            | 41643            |
|------------------|------------------|------------------|
| WATT             | 200W             | 250W             |
| LUMEN            | 24000            | 30000            |
| ANGOLO           | 60° x 110°       | 60° x 110°       |
| COLORE LUCE      | 4000K            | 4000K            |
| CRI              | >80              | >80              |
| FINITURA         | nero             | nero             |
| ALIMENTAZIONE    | 220-240V 50/60Hz | 220-240V 50/60Hz |
| PF               | >0,9             | >0,9             |
| T° D'ESERCIZIO   | -40°÷70°C        | -40°÷70°C        |
| KG               | 9,2              | 10,3             |
| VITA UTILE MEDIA | 50000h           | 50000h           |

# PRO\_STAGNALED\_IP65



# STAGNA\_IP65



Corpo in ABS e diffusore in PS  
 Base struttura interna in metallo  
 600mm 4 clips di chiusura  
 1200mm 10 clips di chiusura  
 1500mm 12 clips di chiusura  
 Collegamento diretto tensione di rete  
 Solo per tubi LED 230V

ABS body + PS diffuser  
 Internal tray in plated iron  
 600mm 4 latches  
 1200mm 10 latches  
 1500mm 12 latches  
 Direct connection to mains voltage  
 Only for LED tubes 230V



| <b>CODICE / CODE</b>           | <b>41555</b> | <b>41556</b> | <b>41557</b> | <b>41558</b> | <b>41559</b> | <b>41560</b> |
|--------------------------------|--------------|--------------|--------------|--------------|--------------|--------------|
|                                | Mono         | Mono         | Mono         | Bi           | Bi           | Bi           |
| <b>KG</b>                      | 0.53         | 0.90         | 1.19         | 0.67         | 1.22         | 1.57         |
| <b>PCS</b>                     | 12           | 12           | 8            | 8            | 4            | 4            |
| <b>DIMENSIONI / DIMENSIONS</b> |              |              |              |              |              |              |
| <b>a</b>                       | 655          | 1263         | 1564         | 655          | 1263         | 1564         |
| <b>b</b>                       | 66           | 66           | 66           | 106          | 106          | 106          |
| <b>c</b>                       | 90           | 90           | 90           | 90           | 90           | 90           |



# CARONTE



Proiettore con LED LG alta efficienza  
e driver Meanwell  
Tecnologia avanzata per la gestione  
dissipazione calore  
Riflettore ad alta efficienza  
Schermo in vetro temperato  
Staffa orientabile  
Soluzione risparmio energetico  
Sostituzione apparecchi ioduri metallici

Projector with built-in high efficiency LG LED  
and Meanwell Driver  
Advanced heat management technology  
High efficiency reflector  
Tempered glass screen  
Solid adjustability of the bracket  
Perfect energy saving solution replace HID fittings  
Driver included

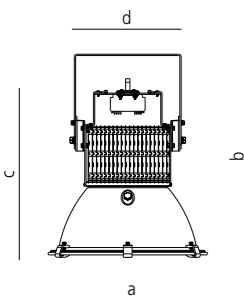

| CODICE / CODE                  | 41563        | 41564        | 41565        | 41566        | 41567        | 41568        | 41569        | 41570        |
|--------------------------------|--------------|--------------|--------------|--------------|--------------|--------------|--------------|--------------|
| BEAM                           | 60°          | 60°          | 90°          | 90°          | 60°          | 60°          | 90°          | 90°          |
| COLORE / COLOUR                | nero/black   | nero/black   | nero/black   | nero/black   | nero/black   | nero/black   | nero/black   | nero/black   |
| COLORE LUCE / COLOR T          | 4000K        | 6000K        | 4000K        | 6000K        | 4000K        | 6000K        | 4000K        | 6000K        |
| LUMEN                          | 11000        | 11640        | 11000        | 11640        | 14000        | 15050        | 14000        | 15050        |
| CRI                            | >80          | >80          | >80          | >80          | >80          | >80          | >80          | >80          |
| LED                            | LG3030       | LG3030       | LG3030       | LG3030       | LG3030       | LG3030       | LG3030       | LG3030       |
| WATT                           | 120W         | 120W         | 120W         | 120W         | 150W         | 150W         | 150W         | 150W         |
| PF                             | 0,9          | 0,9          | 0,9          | 0,9          | 0,9          | 0,9          | 0,9          | 0,9          |
| SUPPLY                         | 230V 50/60Hz | 230V 50/60Hz | 230V 50/60Hz | 230V 50/60Hz | 230V 50/60Hz | 230V 50/60Hz | 230V 50/60Hz | 230V 50/60Hz |
| KG                             | 5,3          | 5,3          | 5,3          | 5,3          | 6,07         | 6,07         | 6,07         | 6,07         |
| PCS                            | 1            | 1            | 1            | 1            | 1            | 1            | 1            | 1            |
| <b>DIMENSIONI / DIMENSIONS</b> |              |              |              |              |              |              |              |              |
| a                              | 374          | 374          | 374          | 374          | 374          | 374          | 374          | 374          |
| b                              | 459          | 459          | 459          | 459          | 467          | 467          | 467          | 467          |
| c                              | 410          | 410          | 410          | 410          | 410          | 410          | 410          | 410          |
| d                              | 246          | 246          | 246          | 246          | 266          | 266          | 266          | 266          |



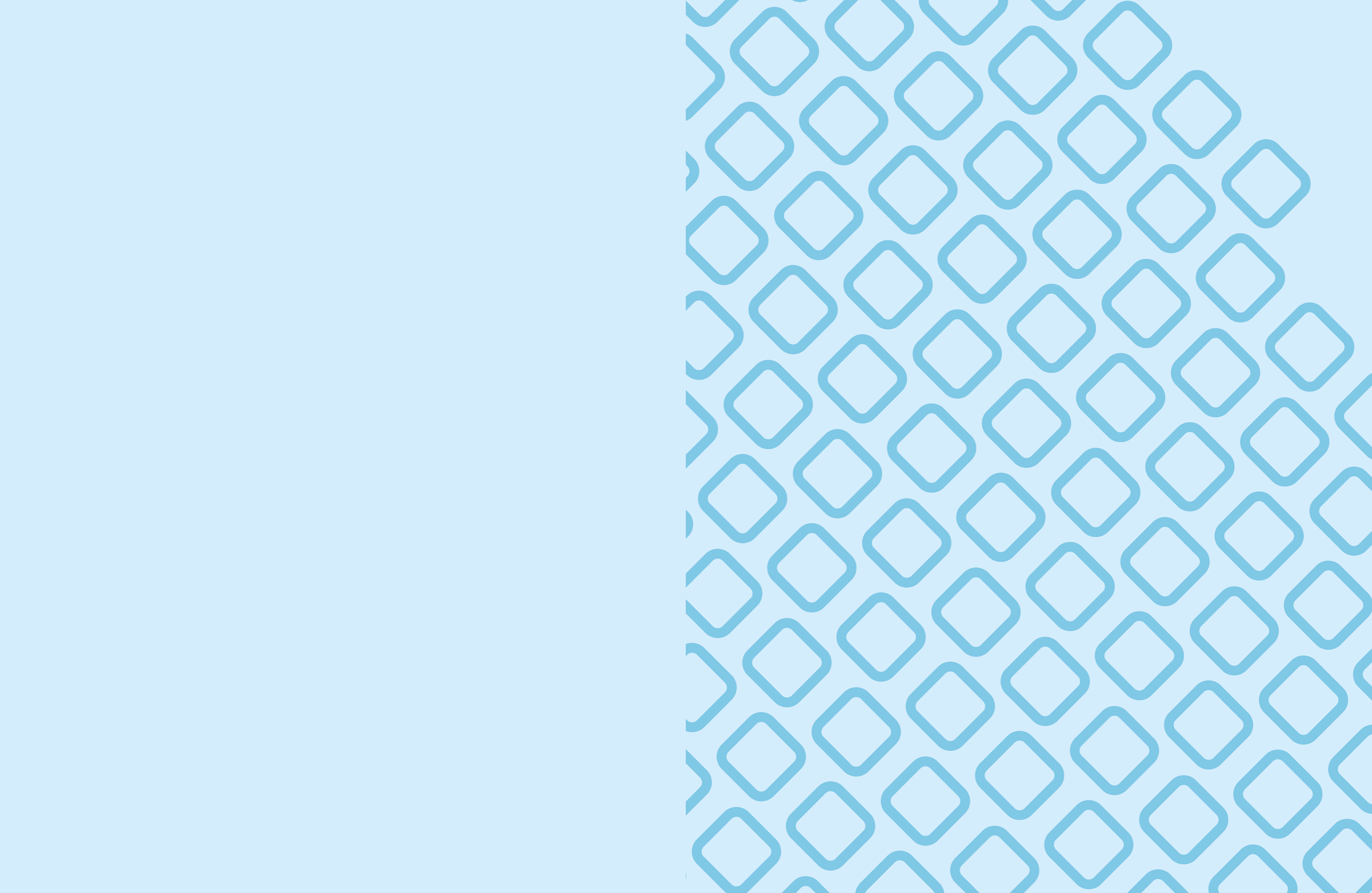

# ATLANTE



Proiettore LED integrato  
Corpo in pressofusione di alluminio  
Schermo in vetro temperato trasparente  
Driver incluso

LED Floodlight  
Die-cast aluminium body  
Tempered transparent glass  
Built-in driver

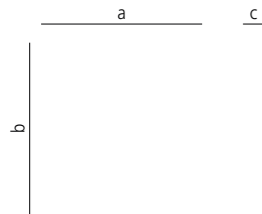

# LAMPO



Proiettore LED integrato nero  
Corpo in pressofusione di alluminio  
Diffusore in vetro trasparente e driver integrato

Black LED Floodlight  
Die-cast aluminium body  
Transparent glass diffuser  
Built-in driver

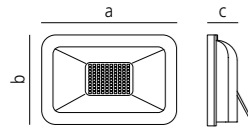

ACCESSORI  
ACCESSORIES

11074 Picchetto nero/Black spike

| CODICE / CODE                  | 40552            | 40553            | 40554            | 40555            | 40568            |
|--------------------------------|------------------|------------------|------------------|------------------|------------------|
| BEAM                           | 120°             | 120°             | 120°             | 120°             | 120°             |
| COLORE / COLOUR                | nero/black       | nero/black       | nero/black       | nero/black       | nero/black       |
| COLORE LUCE / COLOR T          | 3000K            | 3000K            | 3000K            | 3000K            | 3000K            |
| LUMEN                          | 802              | 1605             | 2410             | 4050             | 7203             |
| CRI                            | >80              | >80              | >80              | >80              | >80              |
| WATT                           | 10W              | 20W              | 30W              | 50W              | 100W             |
| PF                             | > 0,9            | > 0,9            | > 0,9            | > 0,9            | > 0,9            |
| SUPPLY                         | 220/240V 50/60Hz | 220/240V 50/60Hz | 220/240V 50/60Hz | 220/240V 50/60Hz | 220/240V 50/60Hz |
| KG                             | 0,214            | 0,374            | 0,564            | 0,755            | 1,4              |
| PCS                            | 40               | 40               | 20               | 20               | 10               |
| <b>DIMENSIONI / DIMENSIONS</b> |                  |                  |                  |                  |                  |
| a                              | 100              | 147              | 190              | 220              | 300              |
| b                              | 80               | 103              | 132              | 155              | 200              |
| c                              | 20               | 18               | 18               | 19               | 20               |

| CODICE / CODE                  | 40556            | 40557            | 40558            | 40559            | 40569            |
|--------------------------------|------------------|------------------|------------------|------------------|------------------|
| BEAM                           | 120°             | 120°             | 120°             | 120°             | 120°             |
| COLORE / COLOUR                | nero/black       | nero/black       | nero/black       | nero/black       | nero/black       |
| COLORE LUCE / COLOR T          | 4000K            | 4000K            | 4000K            | 4000K            | 4000K            |
| LUMEN                          | 830              | 1700             | 2500             | 4130             | 7380             |
| CRI                            | >80              | >80              | >80              | >80              | >80              |
| WATT                           | 10W              | 20W              | 30W              | 50W              | 100W             |
| PF                             | > 0,9            | > 0,9            | > 0,9            | > 0,9            | > 0,9            |
| SUPPLY                         | 220/240V 50/60Hz | 220/240V 50/60Hz | 220/240V 50/60Hz | 220/240V 50/60Hz | 220/240V 50/60Hz |
| KG                             | 0,214            | 0,374            | 0,564            | 0,755            | 1,4              |
| PCS                            | 40               | 40               | 20               | 20               | 10               |
| <b>DIMENSIONI / DIMENSIONS</b> |                  |                  |                  |                  |                  |
| a                              | 100              | 147              | 190              | 220              | 300              |
| b                              | 80               | 103              | 132              | 155              | 200              |
| c                              | 20               | 18               | 18               | 19               | 20               |

| CODICE / CODE                  | 40560            | 40561            | 40562            | 40563            | 40570            |
|--------------------------------|------------------|------------------|------------------|------------------|------------------|
| BEAM                           | 120°             | 120°             | 120°             | 120°             | 120°             |
| COLORE / COLOUR                | nero/black       | nero/black       | nero/black       | nero/black       | nero/black       |
| COLORE LUCE / COLOR T          | 6000K            | 6000K            | 6000K            | 6000K            | 6000K            |
| LUMEN                          | 850              | 1720             | 2700             | 4500             | 7470             |
| CRI                            | >80              | >80              | >80              | >80              | >80              |
| WATT                           | 10W              | 20W              | 30W              | 50W              | 100W             |
| PF                             | > 0,9            | > 0,9            | > 0,9            | > 0,9            | > 0,9            |
| SUPPLY                         | 220/240V 50/60Hz | 220/240V 50/60Hz | 220/240V 50/60Hz | 220/240V 50/60Hz | 220/240V 50/60Hz |
| KG                             | 0,214            | 0,374            | 0,564            | 0,755            | 1,4              |
| PCS                            | 40               | 40               | 20               | 20               | 10               |
| <b>DIMENSIONI / DIMENSIONS</b> |                  |                  |                  |                  |                  |
| a                              | 100              | 147              | 190              | 220              | 300              |
| b                              | 80               | 103              | 132              | 155              | 200              |
| c                              | 20               | 18               | 18               | 19               | 20               |

# LAMPO



Proiettore LED integrato bianco  
Corpo in pressofusione di alluminio  
Diffusore in vetro trasparente e driver integrato

White LED Floodlight  
Die-cast aluminium body  
Transparent glass diffuser  
Built-in driver

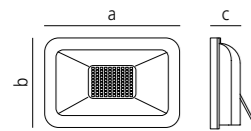

ACCESSORI  
ACCESSORIES

11075 Picchetto bianco/White spike

| CODICE / CODE                  | 41149            | 41150            | 41151            | 41152            | 41161            |
|--------------------------------|------------------|------------------|------------------|------------------|------------------|
| BEAM                           | 120°             | 120°             | 120°             | 120°             | 120°             |
| COLORE / COLOUR                | bianco/white     | bianco/white     | bianco/white     | bianco/white     | bianco/white     |
| COLORE LUCE / COLOR T          | 3000K            | 3000K            | 3000K            | 3000K            | 3000K            |
| LUMEN                          | 802              | 1605             | 2410             | 4050             | 7203             |
| CRI                            | >80              | >80              | >80              | >80              | >80              |
| WATT                           | 10W              | 20W              | 30W              | 50W              | 100W             |
| PF                             | > 0,9            | > 0,9            | > 0,9            | > 0,9            | > 0,9            |
| SUPPLY                         | 220/240V 50/60Hz | 220/240V 50/60Hz | 220/240V 50/60Hz | 220/240V 50/60Hz | 220/240V 50/60Hz |
| KG                             | 0,214            | 0,374            | 0,564            | 0,755            | 1,4              |
| PCS                            | 40               | 40               | 20               | 20               | 10               |
| <b>DIMENSIONI / DIMENSIONS</b> |                  |                  |                  |                  |                  |
| a                              | 100              | 147              | 190              | 220              | 300              |
| b                              | 80               | 103              | 132              | 155              | 200              |
| c                              | 20               | 18               | 18               | 19               | 20               |

| CODICE / CODE                  | 41153            | 41154            | 41155            | 41156            | 41162            |
|--------------------------------|------------------|------------------|------------------|------------------|------------------|
| BEAM                           | 120°             | 120°             | 120°             | 120°             | 120°             |
| COLORE / COLOUR                | bianco/white     | bianco/white     | bianco/white     | bianco/white     | bianco/white     |
| COLORE LUCE / COLOR T          | 4000K            | 4000K            | 4000K            | 4000K            | 4000K            |
| LUMEN                          | 830              | 1700             | 2500             | 4130             | 7380             |
| CRI                            | >80              | >80              | >80              | >80              | >80              |
| WATT                           | 10W              | 20W              | 30W              | 50W              | 100W             |
| PF                             | > 0,9            | > 0,9            | > 0,9            | > 0,9            | > 0,9            |
| SUPPLY                         | 220/240V 50/60Hz | 220/240V 50/60Hz | 220/240V 50/60Hz | 220/240V 50/60Hz | 220/240V 50/60Hz |
| KG                             | 0,214            | 0,374            | 0,564            | 0,755            | 1,4              |
| PCS                            | 40               | 40               | 20               | 20               | 10               |
| <b>DIMENSIONI / DIMENSIONS</b> |                  |                  |                  |                  |                  |
| a                              | 100              | 147              | 190              | 220              | 300              |
| b                              | 80               | 103              | 132              | 155              | 200              |
| c                              | 20               | 18               | 18               | 19               | 20               |

| CODICE / CODE                  | 41157            | 41158            | 41159            | 41160            | 41163            |
|--------------------------------|------------------|------------------|------------------|------------------|------------------|
| BEAM                           | 120°             | 120°             | 120°             | 120°             | 120°             |
| COLORE / COLOUR                | bianco/white     | bianco/white     | bianco/white     | bianco/white     | bianco/white     |
| COLORE LUCE / COLOR T          | 6000K            | 6000K            | 6000K            | 6000K            | 6000K            |
| LUMEN                          | 850              | 1720             | 2700             | 4500             | 7470             |
| CRI                            | >80              | >80              | >80              | >80              | >80              |
| WATT                           | 10W              | 20W              | 30W              | 50W              | 100W             |
| PF                             | > 0,9            | > 0,9            | > 0,9            | > 0,9            | > 0,9            |
| SUPPLY                         | 220/240V 50/60Hz | 220/240V 50/60Hz | 220/240V 50/60Hz | 220/240V 50/60Hz | 220/240V 50/60Hz |
| KG                             | 0,214            | 0,374            | 0,564            | 0,755            | 1,4              |
| PCS                            | 40               | 40               | 20               | 20               | 10               |
| <b>DIMENSIONI / DIMENSIONS</b> |                  |                  |                  |                  |                  |
| a                              | 100              | 147              | 190              | 220              | 300              |
| b                              | 80               | 103              | 132              | 155              | 200              |
| c                              | 20               | 18               | 18               | 19               | 20               |

# LAMPO C/SENSORE



Proiettore LED integrato nero con sensore orientabile  
Corpo in pressofusione di alluminio  
Diffusore in vetro trasparente e driver integrato

Black LED Floodlight with adjustable sensor  
Die-cast aluminium body  
Transparent glass diffuser  
Built-in driver

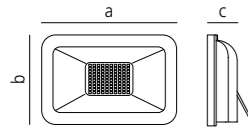

ACCESSORI  
ACCESSORIES

11074 Picchetto nero/Black spike  
11075 Picchetto bianco/White spike

|                                |                  |                  |                  |                  |
|--------------------------------|------------------|------------------|------------------|------------------|
| <b>CODICE / CODE</b>           | 41224            | 41225            | 41226            | 41227            |
| <b>BEAM</b>                    | 120°             | 120°             | 120°             | 120°             |
| <b>COLORE / COLOUR</b>         | nero/black       | nero/black       | nero/black       | nero/black       |
| <b>COLORE LUCE / COLOR T</b>   | 4000K            | 4000K            | 4000K            | 4000K            |
| <b>LUMEN</b>                   | 830              | 1700             | 2500             | 4130             |
| <b>CRI</b>                     | >80              | >80              | >80              | >80              |
| <b>WATT</b>                    | 10W              | 20W              | 30W              | 50W              |
| <b>PF</b>                      | > 0,9            | > 0,9            | > 0,9            | > 0,9            |
| <b>SUPPLY</b>                  | 220/240V 50/60Hz | 220/240V 50/60Hz | 220/240V 50/60Hz | 220/240V 50/60Hz |
| <b>KG</b>                      | 0,248            | 0,418            | 0,608            | 0,799            |
| <b>PCS</b>                     | 40               | 40               | 20               | 20               |
| <b>DIMENSIONI / DIMENSIONS</b> |                  |                  |                  |                  |
| <b>a</b>                       | 100              | 150              | 192              | 225              |
| <b>b</b>                       | 80               | 107              | 136              | 160              |
| <b>c</b>                       | 12,5             | 14,8             | 15               | 16,6             |

|                                |                  |                  |                  |                  |
|--------------------------------|------------------|------------------|------------------|------------------|
| <b>CODICE / CODE</b>           | 41228            | 41229            | 41230            | 41231            |
| <b>BEAM</b>                    | 120°             | 120°             | 120°             | 120°             |
| <b>COLORE / COLOUR</b>         | nero/black       | nero/black       | nero/black       | nero/black       |
| <b>COLORE LUCE / COLOR T</b>   | 6000K            | 6000K            | 6000K            | 6000K            |
| <b>LUMEN</b>                   | 850              | 1720             | 2700             | 4500             |
| <b>CRI</b>                     | >80              | >80              | >80              | >80              |
| <b>WATT</b>                    | 10W              | 20W              | 30W              | 50W              |
| <b>PF</b>                      | > 0,9            | > 0,9            | > 0,9            | > 0,9            |
| <b>SUPPLY</b>                  | 220/240V 50/60Hz | 220/240V 50/60Hz | 220/240V 50/60Hz | 220/240V 50/60Hz |
| <b>KG</b>                      | 0,248            | 0,418            | 0,608            | 0,799            |
| <b>PCS</b>                     | 40               | 40               | 20               | 20               |
| <b>DIMENSIONI / DIMENSIONS</b> |                  |                  |                  |                  |
| <b>a</b>                       | 100              | 150              | 192              | 225              |
| <b>b</b>                       | 80               | 107              | 136              | 160              |
| <b>c</b>                       | 12,5             | 14,8             | 15               | 16,6             |

|                                |                  |                  |                  |                  |
|--------------------------------|------------------|------------------|------------------|------------------|
| <b>CODICE / CODE</b>           | 41232            | 41233            | 41234            | 41235            |
| <b>BEAM</b>                    | 120°             | 120°             | 120°             | 120°             |
| <b>COLORE / COLOUR</b>         | bianco/white     | bianco/white     | bianco/white     | bianco/white     |
| <b>COLORE LUCE / COLOR T</b>   | 4000K            | 4000K            | 4000K            | 4000K            |
| <b>LUMEN</b>                   | 830              | 1700             | 2500             | 4130             |
| <b>CRI</b>                     | >80              | >80              | >80              | >80              |
| <b>WATT</b>                    | 10W              | 20W              | 30W              | 50W              |
| <b>PF</b>                      | > 0,9            | > 0,9            | > 0,9            | > 0,9            |
| <b>SUPPLY</b>                  | 220/240V 50/60Hz | 220/240V 50/60Hz | 220/240V 50/60Hz | 220/240V 50/60Hz |
| <b>KG</b>                      | 0,248            | 0,418            | 0,608            | 0,799            |
| <b>PCS</b>                     | 40               | 40               | 20               | 20               |
| <b>DIMENSIONI / DIMENSIONS</b> |                  |                  |                  |                  |
| <b>a</b>                       | 100              | 150              | 192              | 225              |
| <b>b</b>                       | 80               | 107              | 136              | 160              |
| <b>c</b>                       | 12,5             | 14,8             | 15               | 16,6             |

|                                |                  |                  |                  |                  |
|--------------------------------|------------------|------------------|------------------|------------------|
| <b>CODICE / CODE</b>           | 41236            | 41237            | 41238            | 41239            |
| <b>BEAM</b>                    | 120°             | 120°             | 120°             | 120°             |
| <b>COLORE / COLOUR</b>         | bianco/white     | bianco/white     | bianco/white     | bianco/white     |
| <b>COLORE LUCE / COLOR T</b>   | 6000K            | 6000K            | 6000K            | 6000K            |
| <b>LUMEN</b>                   | 850              | 1720             | 2700             | 4500             |
| <b>CRI</b>                     | >80              | >80              | >80              | >80              |
| <b>WATT</b>                    | 10W              | 20W              | 30W              | 50W              |
| <b>PF</b>                      | > 0,9            | > 0,9            | > 0,9            | > 0,9            |
| <b>SUPPLY</b>                  | 220/240V 50/60Hz | 220/240V 50/60Hz | 220/240V 50/60Hz | 220/240V 50/60Hz |
| <b>KG</b>                      | 0,248            | 0,418            | 0,608            | 0,799            |
| <b>PCS</b>                     | 40               | 40               | 20               | 20               |
| <b>DIMENSIONI / DIMENSIONS</b> |                  |                  |                  |                  |
| <b>a</b>                       | 100              | 150              | 192              | 225              |
| <b>b</b>                       | 80               | 107              | 136              | 160              |
| <b>c</b>                       | 12,5             | 14,8             | 15               | 16,6             |

# SOFFITTO / PARETE

ESTERNI

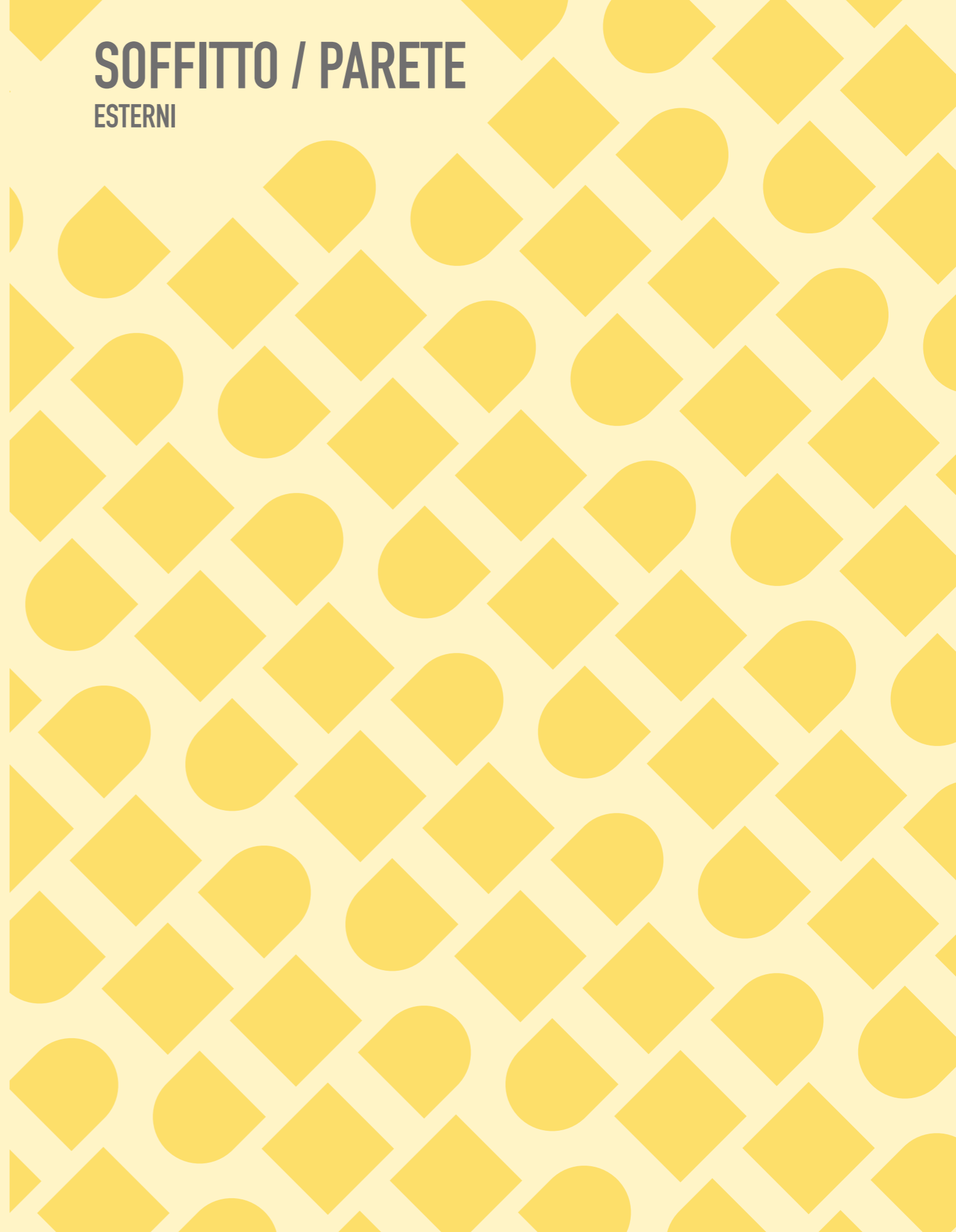



Apparecchio a soffitto LED integrato  
con sensore di presenza  
Corpo in termoplastico  
Diffusore in PC opale

Built-in LED downlight with integrated  
PIR sensor  
Thermoplastic body  
Opal PC diffuser

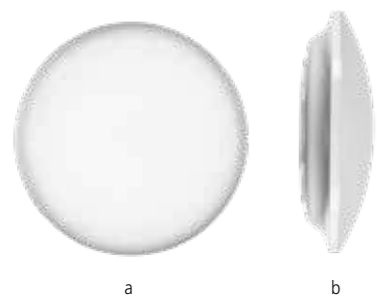

Sensore di presenza 5/6 mt  
Microwave sensor 5/6 mt

| CODICE / CODE                  | 42577        | 42578        |
|--------------------------------|--------------|--------------|
| COLORE / COLOUR                | bianco/white | bianco/white |
| COLORE LUCE / COLOR T          | 4000K        | 6000K        |
| LUMEN                          | 3000         | 3150         |
| CRI                            | 80           | 80           |
| LED                            | Sanan        | Sanan        |
| WATT                           | 30W          | 30W          |
| PF                             | 0,9          | 0,9          |
| SUPPLY                         | 230V 50/60Hz | 230V 50/60Hz |
| KG                             | 0,152        | 0,152        |
| PCS                            | 20           | 20           |
| <b>DIMENSIONI / DIMENSIONS</b> |              |              |
| <b>a</b>                       | 350          | 350          |
| <b>b</b>                       | 102          | 102          |



Apparecchio a soffitto LED integrato  
Corpo in alluminio verniciato  
Schermo in PC opale  
Driver integrato

Ceiling fitting with built-in LED  
Painted aluminium body  
Opal PC screen  
Built-in driver



| CODICE / CODE                  | 40232        | 40234        |
|--------------------------------|--------------|--------------|
| COLORE / COLOUR                | bianco/white | bianco/white |
| COLORE LUCE / COLOR T          | 3000K        | 5000K        |
| LUMEN                          | 2000         | 2100         |
| CRI                            | >80          | >80          |
| LED                            | SMD Edison   | SMD Edison   |
| WATT                           | 26W          | 26W          |
| PF                             | 0,95         | 0,95         |
| SUPPLY                         | 230V 50/60Hz | 230V 50/60Hz |
| KG                             | 0,81         | 0,81         |
| PCS                            | 8            | 8            |
| <b>DIMENSIONI / DIMENSIONS</b> |              |              |
| <b>a</b>                       | 240          | 240          |
| <b>b</b>                       | 45           | 45           |



# LUNA\_T



Apparecchio LED integrato  
Corpo in TRP  
Schermo in PC opale  
Driver integrato

Built-in LED fitting  
TRP body  
Opal PC screen  
Built-in driver

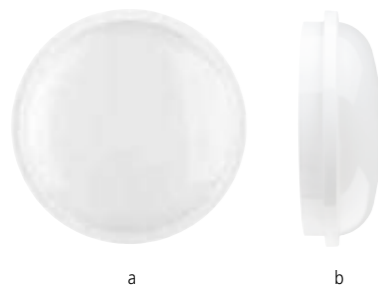

| CODICE / CODE                  | 40303        | 40304        |
|--------------------------------|--------------|--------------|
| BEAM                           | 110°         | 110°         |
| COLORE / COLOUR                | bianco/white | bianco/white |
| COLORE LUCE / COLOR T          | 4000K        | 4000K        |
| LUMEN                          | 1250         | 1650         |
| CRI                            | >80          | >80          |
| LED                            | Epistar      | Epistar      |
| WATT                           | 15W          | 20W          |
| PF                             | >0,5         | >0,5         |
| SUPPLY                         | 230V 50/60Hz | 230V 50/60Hz |
| KG                             | 0,25         | 0,40         |
| PCS                            | 20           | 20           |
| <b>DIMENSIONI / DIMENSIONS</b> |              |              |
| <b>a</b>                       | 167          | 221          |
| <b>b</b>                       | 62           | 72           |

# LUNA\_Q



Apparecchio LED integrato  
Corpo in TRP  
Schermo in PC opale  
Driver integrato

Built-in LED fitting  
TRP body  
Opal PC screen  
Built-in driver



| CODICE / CODE                  | 40305        | 40306        |
|--------------------------------|--------------|--------------|
| BEAM                           | 110°         | 110°         |
| COLORE / COLOUR                | bianco/white | bianco/white |
| COLORE LUCE / COLOR T          | 4000K        | 4000K        |
| LUMEN                          | 1250         | 1650         |
| CRI                            | >80          | >80          |
| LED                            | Epistar      | Epistar      |
| WATT                           | 15W          | 20W          |
| PF                             | >0,5         | >0,5         |
| SUPPLY                         | 230V 50/60Hz | 230V 50/60Hz |
| KG                             | 0,29         | 0,42         |
| PCS                            | 20           | 20           |
| <b>DIMENSIONI / DIMENSIONS</b> |              |              |
| <b>a</b>                       | 215          | 271          |
| <b>b</b>                       | 115          | 146          |
| <b>c</b>                       | 62           | 76           |

# LADY\_T



Apparecchio a soffitto  
Corpo in pressofusione di alluminio verniciato  
Schermo in PC opale

Recessed fitting with built-in LED  
TRP body  
Opal PC diffuser

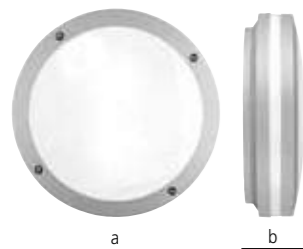

|                                |              |
|--------------------------------|--------------|
| <b>CODICE / CODE</b>           | 40323        |
| <b>COLORE / COLOUR</b>         | grigio/grey  |
| <b>LAMP</b>                    | E27          |
| <b>WATT</b>                    | Max 2x20W    |
| <b>SUPPLY</b>                  | 230V 50/60Hz |
| <b>KG</b>                      | 1,2          |
| <b>PCS</b>                     | 6            |
| <b>DIMENSIONI / DIMENSIONS</b> |              |
| <b>a</b>                       | 300          |
| <b>b</b>                       | 86           |

# LADY\_Q



Apparecchio a soffitto  
Corpo in pressofusione di alluminio verniciato  
Schermo in PC opale

Ceiling fitting  
Painted die-cast aluminium body  
Opal PC screen

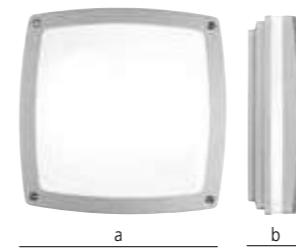
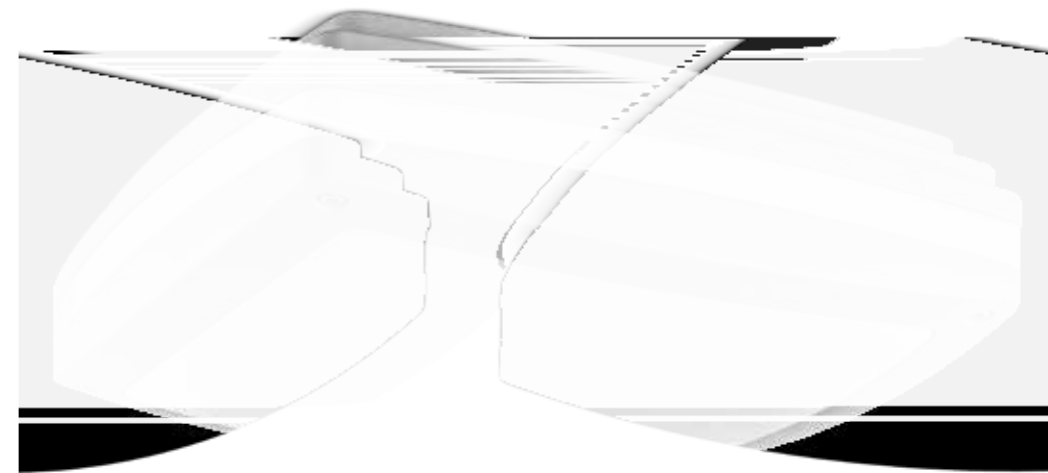

|                                |              |
|--------------------------------|--------------|
| <b>CODICE / CODE</b>           | 40324        |
| <b>COLORE / COLOUR</b>         | grigio/grey  |
| <b>LAMP</b>                    | E27          |
| <b>WATT</b>                    | Max 2x20W    |
| <b>SUPPLY</b>                  | 230V 50/60Hz |
| <b>KG</b>                      | 1,2          |
| <b>PCS</b>                     | 6            |
| <b>DIMENSIONI / DIMENSIONS</b> |              |
| <b>a</b>                       | 300          |
| <b>b</b>                       | 86           |



# WALLY



Apparecchio a parete  
Corpo in pressofusione di alluminio verniciato  
Diffusore in PC opale

Wall fitting  
Painted die-cast aluminium body  
Opal PC diffuser



| CODICE / CODE                  | 42043        | 42034        |
|--------------------------------|--------------|--------------|
| COLORE / COLOUR                | grigio/grey  | nero/black   |
| LAMP                           | E27          | E27          |
| WATT                           | Max 52W      | Max 52W      |
| SUPPLY                         | 230V 50/60Hz | 230V 50/60Hz |
| KG                             | 0,9          | 0,9          |
| PCS                            | 12           | 12           |
| <b>DIMENSIONI / DIMENSIONS</b> |              |              |
| a                              | 250          | 250          |
| b                              | 120          | 120          |
| c                              | 135          | 135          |

# WALLY OPEN



Apparecchio a parete  
Corpo in pressofusione di alluminio verniciato  
Diffusore in PC opale

Wall fitting  
Painted die-cast aluminium body  
Opal PC diffuser

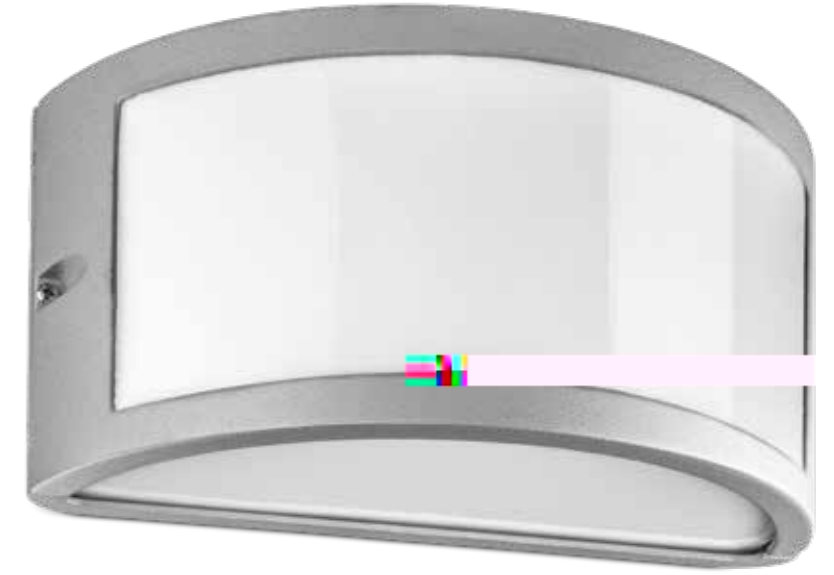

| CODICE / CODE                  | 40205        |
|--------------------------------|--------------|
| COLORE / COLOUR                | grigio/grey  |
| LAMP                           | E27          |
| WATT                           | Max 52W      |
| SUPPLY                         | 230V 50/60Hz |
| KG                             | 0,88         |
| PCS                            | 12           |
| <b>DIMENSIONI / DIMENSIONS</b> |              |
| a                              | 250          |
| b                              | 120          |
| c                              | 135          |

# ELEGANT



Paletto  
Corpo in pressofusione di alluminio verniciato  
Diffusore in PC opale

Pole  
Painted die-cast aluminium body  
Opal PC diffuser

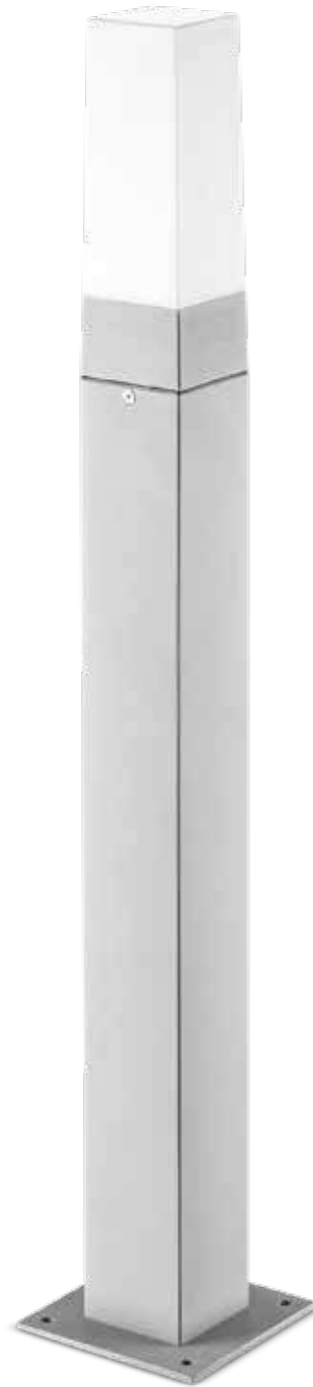
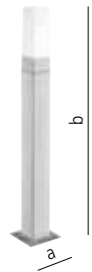

|                                |              |
|--------------------------------|--------------|
| <b>CODICE / CODE</b>           | 40322        |
| <b>COLORE / COLOUR</b>         | grigio/grey  |
| <b>LAMP</b>                    | E27          |
| <b>WATT</b>                    | Max 15W      |
| <b>SUPPLY</b>                  | 230V 50/60Hz |
| <b>KG</b>                      | 1,4          |
| <b>PCS</b>                     | 6            |
| <b>DIMENSIONI / DIMENSIONS</b> |              |
| <b>a</b>                       | 113          |
| <b>b</b>                       | 700          |

# RINGO



Incasso calpestabile LED integrato  
Corpo in alluminio anodizzato  
Cassaforma in PVC  
Driver escluso

Walk-over recessed fitting with built-in LED  
Anodized aluminium body  
PVC framework  
Driver not included

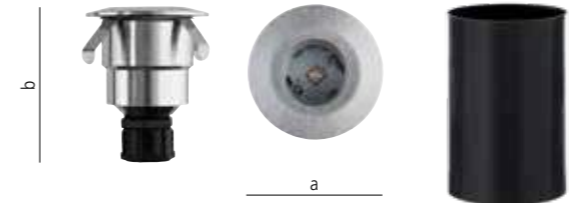

|                                |           |           |
|--------------------------------|-----------|-----------|
| <b>CODICE / CODE</b>           | 42536     | 42541     |
| <b>BEAM</b>                    | 60°       | 60°       |
| <b>COLORE LUCE / COLOR T</b>   | 3000K     | 5000K     |
| <b>LUMEN</b>                   | 70        | 90        |
| <b>LED</b>                     | RE-FOND   | RE-FOND   |
| <b>WATT</b>                    | 1W        | 1W        |
| <b>SUPPLY</b>                  | 12V DC/AC | 12V DC/AC |
| <b>FORO / HOLE</b>             | ø35       | ø35       |
| <b>KG</b>                      | 0.15      | 0.15      |
| <b>PCS</b>                     | 50        | 50        |
| <b>DIMENSIONI / DIMENSIONS</b> |           |           |
| <b>a</b>                       | 40        | 40        |
| <b>b</b>                       | 57        | 57        |
| <b>c</b>                       | 70        | 70        |





| <b>CODICE / CODE</b>           | <b>45608</b> | <b>45609</b> | <b>45598</b> | <b>45599</b> |
|--------------------------------|--------------|--------------|--------------|--------------|
| <b>COLORE LUCE / COLOR T</b>   | 3000K        | 3000K        | 5000K        | 5000K        |
| <b>LUMEN</b>                   | 65           | 130          | 90           | 195          |
| <b>LED</b>                     | RE-FOND      | RE-FOND      | RE-FOND      | RE-FOND      |
| <b>WATT</b>                    | 1,5W         | 3,2W         | 1,5W         | 3,2W         |
| <b>SUPPLY</b>                  | 230V 50/60Hz | 230V 50/60Hz | 230V 50/60Hz | 230V 50/60Hz |
| <b>FORO / HOLE</b>             | 139x56       | 190x65       | 139x56       | 190x65       |
| <b>KG</b>                      | 0,3          | 0,83         | 0,3          | 0,83         |
| <b>PCS</b>                     | 50           | 12           | 50           | 12           |
| <b>DIMENSIONI / DIMENSIONS</b> |              |              |              |              |
| <b>a</b>                       | 146          | 196          | 146          | 196          |
| <b>b</b>                       | 60           | 70           | 60           | 70           |
| <b>c</b>                       | 60           | 60           | 60           | 60           |

---



---



---



---



---



---

# TRASFORMATORI ACCESSORI





# TRASFORMATORI ELETTRONICI

Trasformatore elettronico LED 12V

LED electronic transformer 12V



|                               |  |
|-------------------------------|--|
| <b>CODICE / CODE</b>          | <b>21918</b>   |
|                               | 220-240V AC / 50Hz<br>Collegare max 3 lampadine LED<br>Connect max 3 LED bulbs |
| <b>PRIMARIO / MAINS</b>       |  |
| <b>SECONDARIO / SECONDARY</b> | 12V  |
| <b>W</b>                      | 2-30W  |
| <b>IP</b>                     | 20   |
| <b>DIMENSIONS</b>             | 80 x 38 x H28  |



|                               |  |
|-------------------------------|--|
| <b>CODICE / CODE</b>          | <b>22918</b>   |
|                               | 220-240V AC / 50Hz<br>Collegare max 4/5 lampadine LED<br>Connect max 4/5 LED bulbs |
| <b>PRIMARIO / MAINS</b>       |  |
| <b>SECONDARIO / SECONDARY</b> | 12V  |
| <b>W</b>                      | 2-50W  |
| <b>IP</b>                     | 20   |
| <b>DIMENSIONS</b>             | 117 x 32 x H20   |

# KIT GU10/GZ10

Kit GU10/GZ 10



|                      |              |
|----------------------|--------------|
| <b>CODICE / CODE</b> | <b>40482</b> |
|----------------------|--------------|

# PRICE LIST

[Redacted]

[Redacted]

[Redacted]

[Redacted]

[Redacted]

[Redacted]

[Redacted]

[Redacted]

[Redacted]

[Redacted]

[Redacted]

[Redacted]

[Redacted]

[Redacted]

[Redacted]

# PRICE LIST

LISTINO IVA ESCLUSA – ECO-FEE INCLUSO

| Codice  | €      | Pag          | Codice | €     | Pag | Codice | €      | Pag | Codice | €     | Pag | Codice | €      | Pag | Codice | €      | Pag   |
|---------|--------|--------------|--------|-------|-----|--------|--------|-----|--------|-------|-----|--------|--------|-----|--------|--------|-------|
| 11074   | 4.00   | 54           | 40442  | 59.43 | 35  | 40753  | 43.30  | 22  | 41228  | 21.50 | 59  | 41563  | 474.00 | 48  | 42540  | 28.80  | 10,11 |
| 11075   | 4.00   | 56           | 40482  | 2.42  | 81  | 41006  | 33.00  | 32  | 41229  | 29.60 | 59  | 41564  | 474.00 | 48  | 42541  | 44.10  | 73    |
| 11622/2 | 18.90  | 8,9          | 40511  | 18.90 | 20  | 41007  | 33.00  | 32  | 41230  | 37.90 | 59  | 41565  | 474.00 | 48  | 42542  | 54.00  | 10,11 |
| 11622/3 | 30.90  | 10,11        | 40512  | 18.90 | 20  | 41008  | 46.80  | 32  | 41231  | 46.90 | 59  | 41566  | 474.00 | 48  | 42577  | 89.00  | 62    |
| 21918   | 11.00  | 80           | 40513  | 29.88 | 20  | 41009  | 46.80  | 32  | 41232  | 21.50 | 59  | 41567  | 597.00 | 48  | 42578  | 89.00  | 62    |
| 22918   | 28.00  | 80           | 40514  | 29.88 | 20  | 41010  | 69.00  | 32  | 41233  | 29.60 | 59  | 41568  | 597.00 | 48  | 42609  | 109.00 | 41    |
| 40015   | 7.25   | 74, 75       | 40515  | 36.30 | 20  | 41011  | 69.00  | 32  | 41234  | 37.90 | 59  | 41569  | 597.00 | 48  | 42610  | 129.00 | 41    |
| 40016   | 11.87  | 74, 75       | 40516  | 36.30 | 20  | 41012  | 45.60  | 33  | 41235  | 46.90 | 59  | 41570  | 597.00 | 48  | 42611  | 149.00 | 41    |
| 40154   | 44.63  | 68           | 40517  | 38.94 | 20  | 41013  | 45.60  | 33  | 41236  | 21.50 | 59  | 41585  | 156.00 | 36  | 42612  | 109.00 | 40    |
| 40155   | 72.98  | 68           | 40518  | 38.94 | 20  | 41014  | 63.00  | 33  | 41237  | 29.60 | 59  | 41586  | 156.00 | 36  | 42613  | 129.00 | 40    |
| 40157   | 41.48  | 74           | 40552  | 9.90  | 55  | 41015  | 63.00  | 33  | 41238  | 37.90 | 59  | 41597  | 417.00 | 44  | 42614  | 149.00 | 40    |
| 40182   | 93.45  | 74           | 40553  | 15.00 | 55  | 41149  | 9.90   | 57  | 41239  | 46.90 | 59  | 41598  | 470.00 | 44  | 43439  | 28.49  | 34    |
| 40205   | 34.65  | 71           | 40554  | 24.60 | 55  | 41150  | 15.00  | 57  | 41243  | 5.20  | 28  | 41599  | 615.00 | 44  | 43440  | 41.40  | 34    |
| 40210   | 32.44  | 24           | 40555  | 33.60 | 55  | 41151  | 24.60  | 57  | 41244  | 5.20  | 28  | 41640  | 87.60  | 46  | 43441  | 39.07  | 35    |
| 40211   | 32.44  | 25           | 40556  | 9.90  | 55  | 41152  | 33.60  | 57  | 41245  | 6.20  | 28  | 41641  | 110.40 | 46  | 43442  | 58.10  | 35    |
| 40232   | 136.50 | 63           | 40557  | 15.00 | 55  | 41153  | 9.90   | 57  | 41246  | 6.20  | 28  | 41642  | 609.00 | 45  | 43544  | 34.37  | 39    |
| 40234   | 136.50 | 63           | 40558  | 24.60 | 55  | 41154  | 15.00  | 57  | 41247  | 6.20  | 28  | 41643  | 729.00 | 45  | 43545  | 46.88  | 39    |
| 40303   | 22.14  | 64           | 40559  | 33.60 | 55  | 41155  | 24.60  | 57  | 41248  | 6.40  | 29  | 41644  | 206.60 | 46  | 45598  | 33.60  | 76    |
| 40304   | 26.10  | 64           | 40560  | 9.90  | 55  | 41156  | 33.60  | 57  | 41249  | 6.40  | 29  | 41645  | 229.40 | 46  | 45599  | 44.63  | 76    |
| 40305   | 22.14  | 65           | 40561  | 15.00 | 55  | 41157  | 9.90   | 57  | 41250  | 7.80  | 29  | 41649  | 75.00  | 8   | 45600  | 31.40  | 77    |
| 40306   | 26.10  | 65           | 40562  | 24.60 | 55  | 41158  | 15.00  | 57  | 41251  | 7.80  | 29  | 41650  | 75.00  | 8   | 45601  | 31.40  | 77    |
| 40314   | 42.00  | 8,9,10,11,12 | 40563  | 33.60 | 55  | 41159  | 24.60  | 57  | 41252  | 7.80  | 29  | 41651  | 82.00  | 10  | 45608  | 33.60  | 76    |
| 40322   | 78.00  | 72           | 40568  | 60.00 | 55  | 41160  | 33.60  | 57  | 41253  | 55.80 | 16  | 41652  | 82.00  | 10  | 45609  | 44.63  | 76    |
| 40323   | 61.95  | 66           | 40569  | 60.00 | 55  | 41161  | 60.00  | 57  | 41254  | 55.80 | 16  | 41653  | 85.00  | 9   | 45610  | 31.40  | 77    |
| 40324   | 61.95  | 67           | 40570  | 60.00 | 55  | 41162  | 60.00  | 57  | 41255  | 84.54 | 17  | 41654  | 85.00  | 9   | 45611  | 31.40  | 77    |
| 40326   | 11.34  | 27           | 40571  | 21.60 | 18  | 41163  | 60.00  | 57  | 41256  | 84.54 | 17  | 41655  | 92.00  | 11  |        |        |       |
| 40327   | 12.43  | 27           | 40572  | 29.80 | 18  | 41170  | 150.00 | 52  | 41544  | 34.59 | 39  | 41656  | 92.00  | 11  |        |        |       |
| 40348   | 65.78  | 69           | 40573  | 37.00 | 18  | 41171  | 234.00 | 52  | 41545  | 48.04 | 39  | 41657  | 57.00  | 12  |        |        |       |
| 40365   | 15.75  | 38           | 40574  | 40.00 | 18  | 41172  | 288.00 | 52  | 41555  | 17.36 | 47  | 42034  | 44.52  | 70  |        |        |       |
| 40366   | 15.75  | 38           | 40575  | 21.60 | 18  | 41183  | 70.00  | 52  | 41556  | 23.56 | 47  | 42043  | 44.52  | 70  |        |        |       |
| 40378   | 139.36 | 37           | 40576  | 29.80 | 18  | 41224  | 21.50  | 59  | 41557  | 35.96 | 47  | 42535  | 41.48  | 75  |        |        |       |
| 40439   | 28.49  | 34           | 40577  | 37.00 | 18  | 41225  | 29.60  | 59  | 41558  | 21.70 | 47  | 42536  | 44.10  | 73  |        |        |       |
| 40440   | 41.89  | 34           | 40578  | 40.00 | 18  | 41226  | 37.90  | 59  | 41559  | 29.76 | 47  | 42538  | 42.00  | 8,9 |        |        |       |
| 40441   | 39.07  | 35           | 40752  | 43.30 | 22  | 41227  | 46.90  | 59  | 41560  | 39.65 | 47  | 42539  | 22.80  | 8,9 |        |        |       |

I nostri prodotti sono soggetti a continui sviluppi e cambiamenti. Ci riserviamo il diritto di mutare le specifiche o eliminare alcuni modelli senza preavviso. I colori stampati in questo catalogo non possono produrre fedelmente le tinte dei nostri prodotti. Pertanto sono da considerarsi puramente indicativi. È vietata la riproduzione, anche parziale, di questo catalogo in qualsiasi forma e su qualsiasi supporto senza autorizzazione.

Our products are subjected to continuous changes and developments. We reserve the right to modify the specification or eliminate some models without notice. The colours printed in this catalogue may not reproduce faithfully the hues of the products and have to be considered merely indicative. Total or partial reproduction of this catalogue in any form is not allowed without our prior consent.

# INDICE ALFABETICO

|                           |    |                            |    |
|---------------------------|----|----------------------------|----|
| ATLANTE                   | 52 | PANNELLO LED 30X120        | 10 |
| ATON                      | 45 | PANNELLO LED 30X120 UGR<19 | 11 |
| BRICK                     | 76 | PANNELLO TONDO             | 36 |
| CARONTE                   | 48 | PLAFOLED_Q                 | 33 |
| DIN                       | 24 | PLAFOLED_T                 | 32 |
| DON                       | 25 | PRO_STAGNALED_IP65         | 46 |
| DISCO                     | 39 | PROTEO                     | 69 |
| ERCOLE                    | 16 | QUADRO_30                  | 22 |
| ERCOLE IP54               | 17 | RINGO                      | 73 |
| ELEGANT                   | 72 | SIGNUS                     | 68 |
| HELIOS_50 FISSO           | 28 | SPLASH                     | 27 |
| HELIOS_50 REGOLABILE      | 29 | STAGNA_IP65                | 47 |
| HYDRA_Q                   | 35 | TRASFORMATORI ELETTRONICI  | 80 |
| HYDRA_T                   | 34 | VULCANO EVO                | 18 |
| HORUS                     | 44 | WALLY                      | 70 |
| ISIDE                     | 37 | WALLY OPEN                 | 71 |
| KANDO_Q                   | 75 | ZAGOR                      | 62 |
| KANDO_T                   | 74 |                            |    |
| KIT GU10/GZ/10            | 81 |                            |    |
| LADY_Q                    | 67 |                            |    |
| LADY_T                    | 66 |                            |    |
| LAMPO                     | 54 |                            |    |
| LAMPO C/SENSORE           | 58 |                            |    |
| LEDSPOT_TRP1              | 20 |                            |    |
| LUCE QUADRO               | 40 |                            |    |
| LUNA_O                    | 65 |                            |    |
| LUNA_T                    | 64 |                            |    |
| MAYA                      | 38 |                            |    |
| MOON                      | 63 |                            |    |
| PANNELLO BACKLITE         | 12 |                            |    |
| PANNELLI LED 60X60        | 08 |                            |    |
| PANNELLO LED 60X60 UGR<19 | 09 |                            |    |



**MARINOCRISTAL**

Marino Cristal S.p.A.

Via Guardia del Consiglio 29

47899 Serravalle - Rep. di San Marino

Tel. (+378) 0549-901188

Fax (+378) 0549-900612

[www.marinocristal.com](http://www.marinocristal.com)

email: [marinocristal@marinocristal.com](mailto:marinocristal@marinocristal.com)

È vietata la riproduzione anche parziale di questo catalogo  
It is forbidden to reproduce any part of this catalogue