



**SORAA** arc™

arc



SORAA ARC™ IS THE SYNTHESIS OF PERFECT LIGHT AND INSPIRED DESIGN.

STUNNING FORM FOLLOWS REMARKABLE FUNCTION IN FIXTURES ENGINEERED AROUND AN ULTRA THIN PROFILE DIE-CAST HEAT SINK. OPTIMIZED FOR SUPERIOR THERMAL MANAGEMENT AND ENDOWED WITH SORAA'S SIGNATURE QUALITY OF LIGHT, THEY FEATURE RICH COLORS, PERFECTLY RENDERED WHITES, AND CLEAN, CRISP BEAMS. FOR A WIDE RANGE OF APPLICATIONS, THIS IS LIGHTING AT THE TOP OF THE CURVE.



DESIGNED FROM THE INSIDE OUT.

# CONTENTS

4	APPLICATIONS
10	ARC SERIES
12	TRACK   ART
14	PENDANT   ARP
16	ADJUSTABLE   ARA
18	DOWNLIGHT   DEA/ DEF/ DEW
22	SORAA SNAP SYSTEM
26	LIGHT SPECIFICATIONS

# MUSEUMS



Soraa Arc features Soraa VIVID Color™ and Soraa Natural White™ rendering both colors and whites naturally and perfectly, ideal for settings and applications that demand accuracy and ultra-clear differentiation.



# arc

## HOSPITALITY



Soraa Arc gives you the ability to set the mood. Crisp, clean, point source optics, and Snap System compatibility give you complete control over the beam, color, and intensity to create truly inviting environments.



# arc

## RETAIL



When colors are richer and shadows are cleaner, products on display come into their own. Soraa's broader visible spectrum, R9, and infinite shades of white help to present merchandise in the right light.



arc  
airc



## RESIDENTIAL



At home, Soraa Arc is lighting that is meant to be seen. In addition to its legendary Soraa VIVID™ color quality, ARC stands on its own, adding to the art and architecture of a beautiful environment.





DOWNLIGHT, UPLIFTED.

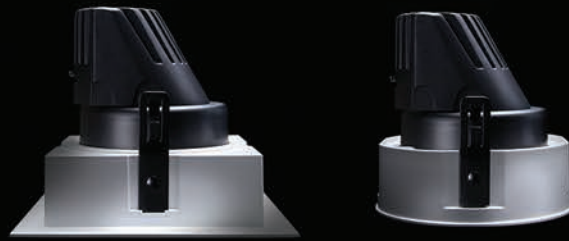

IT'S TIME TO RAISE YOUR EXPECTATIONS. INTRODUCING A NEW ARC IN DOWNLIGHTING FROM SORAA.<sup>®</sup>

# SORAA arc™ SERIES



ART 50mm



ART 100mm

TRACK



ARP 50mm



ARP 100mm

PENDANT



ARA 50mm  
Semi-Recessed  
Mount



ARA 50mm  
Recessed Mount



ARA 100mm  
Semi-Recessed  
Mount



ARA 100mm  
Recessed Mount

ADJUSTABLE



DESA 50mm Downlight Square Adjustable (Trim)



DESA 50mm Downlight Square Adjustable (Trimless)



Snap Trim Square



Wall Wash Square



DERA 50mm Downlight Round Adjustable (Trim)



DERA 50mm Downlight Round Adjustable (Trimless)



Snap Trim Round



Wall Wash Round



50mm Snoot



100mm Snoot



50mm Wall Wash



100mm Wall Wash



Clear



Beam Shaping

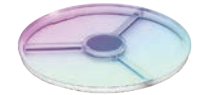

Enhance



Aim

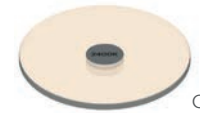

CCT Shifter



Louver

## DOWNLIGHT

50mm 3-in-1 featuring 3.5" (90mm) aperture with 50mm lens in adjustable, fixed, and wall wash

## ACCESSORIES

For spaces that require high precision in lighting design.



TRACK

# SORAA arc™ TRACK

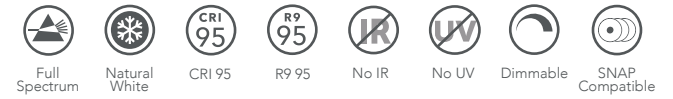

## ORDERING GUIDE

Product SKU	Beam & Wattage	Track Compatibility	CCT	Driver	Finish	Region
<b>ART50</b> Soraa Arc Track, 50mm	<b>10D</b> 10° Narrow Spot - 11W ☺	<b>H</b> H style - 120V	<b>927</b> 2700K	<b>U</b> 120V TRIAC, ELV	<b>B</b> Black	North America
	<b>15D</b> 15° Narrow Spot - 18W ☺	<b>J</b> J style - 120V	<b>930</b> 3000K	<b>U10</b> 120V 0-10V (120 VAC options)	<b>W</b> White	<b>S3</b> EU/APAC
	<b>25D</b> 25° Narrow Flood - 18W	<b>L</b> L style - 120V	<b>940</b> 4000K		<b>S</b> Silver	
	<b>36D</b> 36° Flood - 18W				<b>C</b> Custom	
<b>ART100</b> Soraa Arc Track, 100mm	<b>09D</b> 9° Narrow Spot - 20W ☺	<b>G</b> 3 C1N (Global)		<b>E</b> 230V Phase Dim		
	<b>25D</b> 25° Narrow Flood - 20W	<b>G1</b> 2 C2N (Global)		<b>ED</b> 230V DALI		
	<b>36D</b> 36° Flood - 20W	<b>GC</b> 3 C1N+Data (Global)		<b>E10</b> 230V 0-10V (220-240 VAC options)		
	<b>60D</b> 60° Flood - 20W	<b>GS</b> 3 C1N+Data (Stucchi)				

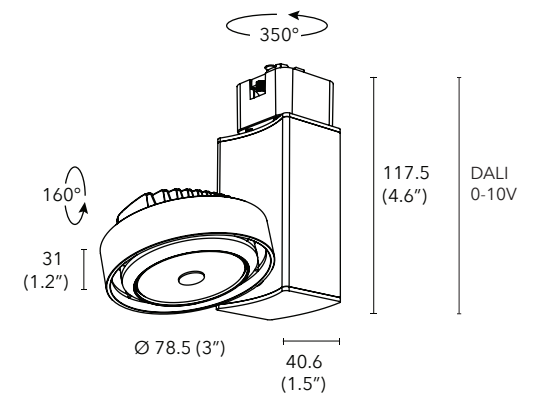
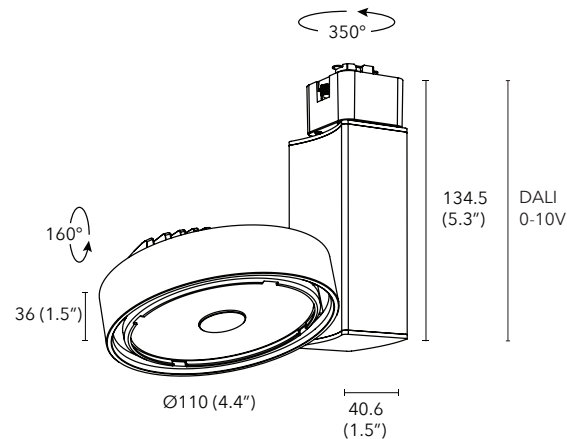



PENDANT



# SORAA arc™ PENDANT

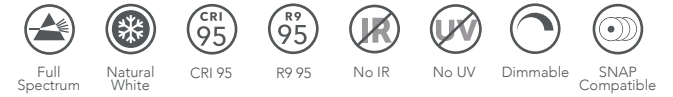

## ORDERING GUIDE

Product SKU	Beam & Wattage	CCT	Driver	Mounting	Finish	Region
<b>ARP50</b> Soraa Arc Pendant, 50mm	<b>10D</b> 10° Narrow Spot - 11W ☺	<b>927</b> 2700K	<b>U</b> 120V TRIAC, ELV <b>U10</b> 120V 0-10V (120 VAC options)	<b>SR</b> Semi Recessed	<b>B</b> Black <b>W</b> White <b>S</b> Silver <b>C</b> Custom	North America <b>S3</b> EU/APAC
	<b>15D</b> 15° Narrow Spot - 18W ☺	<b>930</b> 3000K				
	<b>25D</b> 25° Narrow Flood - 18W	<b>940</b> 4000K				
	<b>36D</b> 36° Flood - 18W					
<b>ARP100</b> Soraa Arc Pendant, 100mm	<b>09D</b> 9° Narrow Spot - 20W ☺		<b>E</b> 230V Phase Dim			
	<b>25D</b> 25° Narrow Flood - 20W		<b>ED</b> 230V DALI			
	<b>36D</b> 36° Flood - 20W		<b>E10</b> 230V 0-10V (220-240 VAC options)			
	<b>60D</b> 60° Wide Flood - 20W					

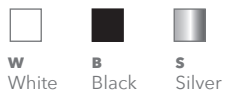

Pendant furnished with 1981mm (78")/side of coated electrical cable, fully adjustable lengths.

230V version supplied with remote driver.

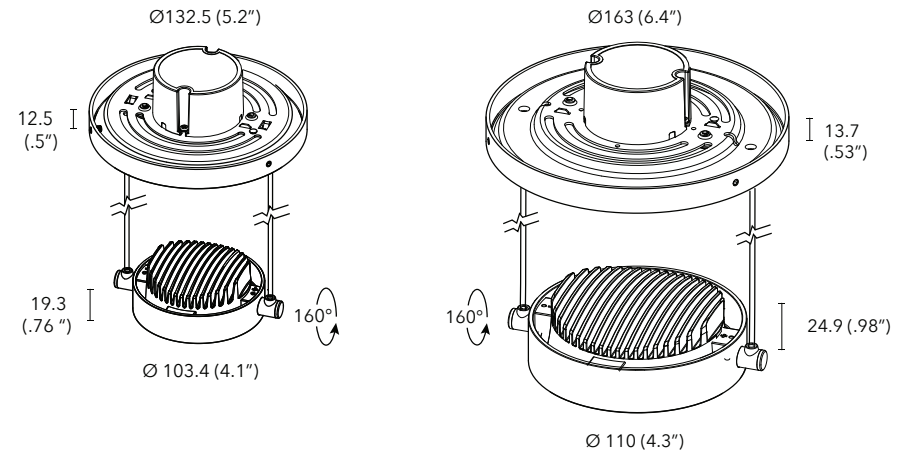



ADJUSTABLE

# SORAA arc™ ADJUSTABLE

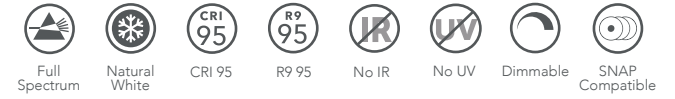

## ORDERING GUIDE

Product SKU	Beam & Wattage	CCT	Driver	Mounting	Finish	Region
<b>ARA50</b> Soraa Arc Adjustable, 50mm	<b>10D</b> 10° Narrow Spot - 11W ☺	<b>927</b> 2700K	<b>U</b> 120V TRIAC, ELV	<b>SR</b> Semi Recessed	<b>B</b> Black	North America
	<b>15D</b> 15° Narrow Spot - 18W ☺	<b>930</b> 3000K	<b>U10</b> 120V 0-10V (120 VAC options)	<b>R</b> Recessed	<b>W</b> White	<b>S3</b> EU/APAC
	<b>25D</b> 25° Narrow Flood - 18W	<b>940</b> 4000K			<b>S</b> Silver	
	<b>36D</b> 36° Flood - 18W				<b>C</b> Custom	
<b>ARA100</b> Soraa Arc Adjustable, 100mm	<b>09D</b> 9° Narrow Spot - 20W ☺		<b>E</b> 230V Phase Dim			
	<b>25D</b> 25° Narrow Flood - 20W		<b>ED</b> 230V DALI			
	<b>36D</b> 36° Flood - 20W		<b>E10</b> 230V 0-10V (220-240 VAC options)			
	<b>60D</b> 60° Wide Flood - 20W					



230V version supplied with remote driver.

Consult specification sheets for CE installation.

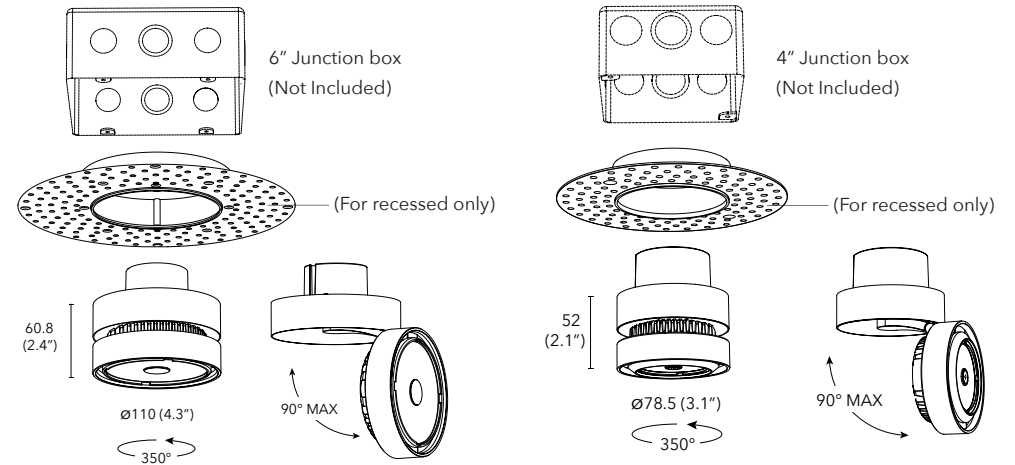



DOWNLIGHT

# SORAA arc™ ADJUSTABLE DOWNLIGHT

3.5" (90mm) aperture, 50mm lens



1

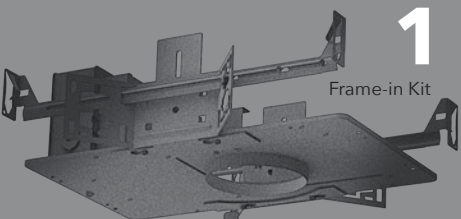

Frame-in Kit

2

Trimless Adapter (Optional)

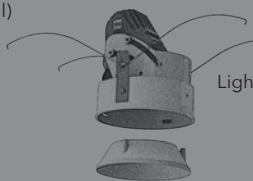

Light Engine & Collar

3

Trim

ORDERING GUIDE

## Step 1 Choose your Installation application

### Downlight Frame-in Kit (NA) or Driver (EU)

- DFR50** Downlight Frame-in Kit (NA Only) Round
- DFS50** Downlight Frame-in Kit (NA Only) Square
- DRD50** Downlight Remodel Driver
- DD50** Downlight Driver Kit (EU)

### IC Rating\*

- IC** IC Rated
- T** Thermally Protected Non-IC
- CP** Chicago Plenum

\*New Construction Only

### Driver

- U** 120V TRIAC, ELV 0-10V (120 VAC options)
- E** 220-240V Phase Dim
- ED** 230V DALI
- E10** 230V 0-10V (220-240 VAC options)

## Step 2 Choose your light experience

### Light Engine

- DERA50** Downlight LE Round Adjustable
- DESA50** Downlight LE Square Adjustable

### Beam & Wattage

- 15D** 15° Narrow Spot - 18W ☼
- 25D** 25° Narrow Flood - 18W
- 36D** 36° Flood - 18W

### CCT

- 927** 2700K
- 930** 3000K
- 940** 4000K

### Mounting\*

- F** Frame-In Kit
- R** Remodel
- \*NA Only

### Collar

- T** Trim
- TL** Trimless

### Finish

- B** Black
- W** White

### Region

- North America
- S3** EU/APAC

## Step 3 Choose your finished look with a SNAP trim

### Snap Trims

- DTRA50** Round Adjustable Downlight
- DTSA50** Square Adjustable Downlight

### Finish

- B** Black
- W** White
- S** Silver
- T** Tangerine
- C** Custom

### Region

- North America
- S3** EU/APAC



W White

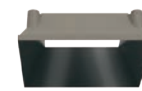

B Black

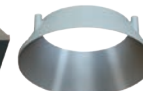

S Silver

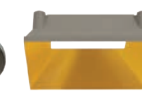

T Tangerine

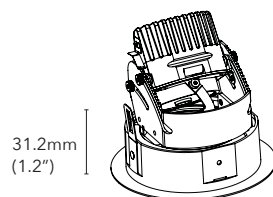

114.3mm (4.5")

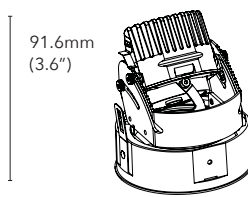

96.1mm (3.78")

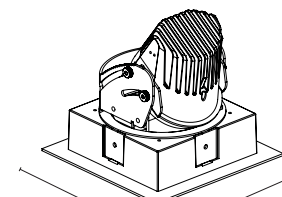

93.2mm (3.66")

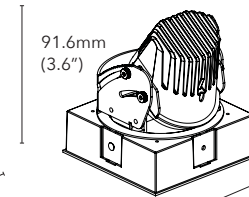

96.4mm (3.8")

# SORAA arc™ FIXED DOWNLIGHT

3.5" (90mm) aperture, 50mm lens



1  
2  
3

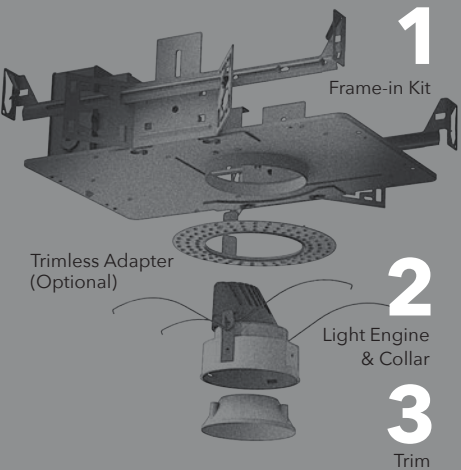

ORDERING GUIDE

## Step 1 Choose your Installation application

### Downlight Frame-in Kit (NA) or Driver (EU)

- DFR50** Downlight Frame-in Kit (NA Only) Round
- DFS50** Downlight Frame-in Kit (NA Only) Square
- DRD50** Downlight Remodel Driver
- DD50** Downlight Driver Kit (EU)

### IC Rating\*

- IC** IC Rated
- T** Thermally Protected Non-IC
- CP** Chicago Plenum

\*New Construction Only

### Driver

- U** 120V TRIAC, ELV 0-10V (120 VAC options)
- E** 220-240V Phase Dim
- ED** 230V DALI
- E10** 230V 0-10V (220-240 VAC options)

## Step 2 Choose your light experience

### Light Engine

- DERF50** Downlight LE Round Fixed
- DESF50** Downlight LE Square Fixed

### Beam & Wattage

- 15D** 15° Narrow Spot - 18W ☺
- 25D** 25° Narrow Flood - 18W
- 36D** 36° Flood - 18W

### CCT

- 927** 2700K
- 930** 3000K
- 940** 4000K

### Mounting\*

- F** Frame-In Kit
  - R** Remodel
- \*NA Only

### Collar

- T** Trim
- TL** Trimless

### Finish

- B** Black
- W** White

### Region

- NA** North America
- S3** EU/APAC

## Step 3 Choose your finished look with a SNAP trim

### Snap Trims

- DTRF50** Round Fixed Downlight
- DTSF50** Square To Round Fixed Downlight

### Finish

- B** Black
- W** White
- S** Silver
- T** Tangerine
- C** Custom

### Region

- NA** North America
- S3** EU/APAC

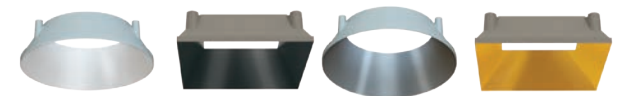

**W** White      **B** Black      **S** Silver      **T** Tangerine

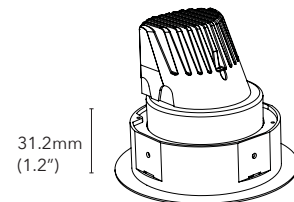

114.3mm (4.5")

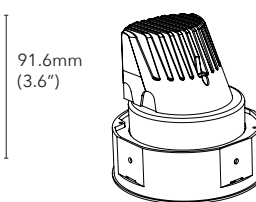

96.1mm (3.78")

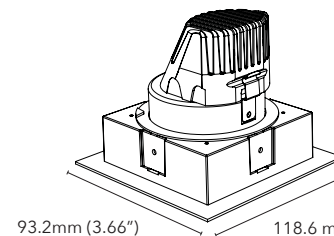

93.2mm (3.66")

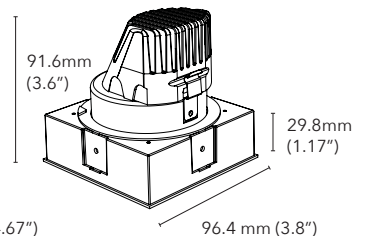

91.6mm (3.6")

29.8mm (1.17")

96.4 mm (3.8")

# SORAA arc™ WALL WASH

3.5" (90mm) aperture



1  
2  
3

ORDERING GUIDE

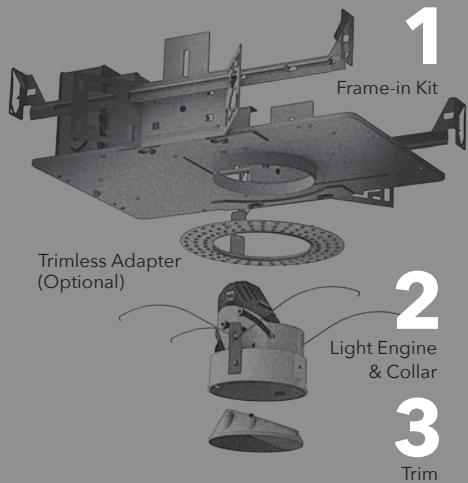

## Step 1 Choose your Installation application

### Downlight Frame-in Kit (NA) or Driver (EU)

- DFR50** Downlight Frame-in Kit (NA Only) Round
- DFS50** Downlight Frame-in Kit (NA Only) Square
- DRD50** Downlight Remodel Driver
- DD50** Downlight Driver Kit (EU)

### IC Rating\*

- IC** IC Rated
- T** Thermally Protected Non-IC
- CP** Chicago Plenum

\*New Construction Only

### Driver

- U** 120V TRIAC, ELV 0-10V (120 VAC options)
- E** 220-240V Phase Dim
- ED** 230V DALI
- E10** 230V 0-10V (220-240 VAC options)

## Step 2 Choose your light experience

### Light Engine

- DERW50** Downlight LE Round Wall Wash
- DESW50** Downlight LE Square Wall Wash

### CCT

- 927** 2700K
- 930** 3000K
- 940** 4000K

### Mounting\*

- F** Frame-In Kit
- R** Remodel
- \*NA Only

### Collar

- T** Trim
- TL** Trimless

### Finish

- B** Black
- W** White

### Region

- North America
- S3** EU/APAC

## Step 3 Choose your finished look with a SNAP trim

### Snap Trims

- DTW50** Round Wall Wash
- DTSW50** Square Wall Wash

### Finish

- W** White
- B** Black
- S** Silver
- T** Tangerine

### Region

- North America
- S3** EU/APAC

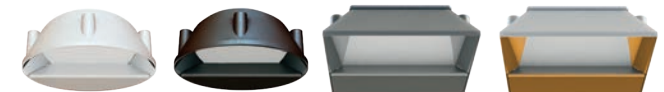

**W** White      **B** Black      **S** Silver      **T** Tangerine

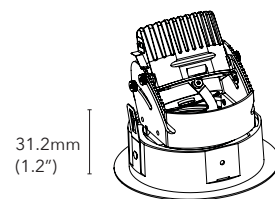

114.3mm (4.5")

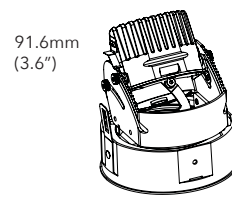

96.1mm (3.78")

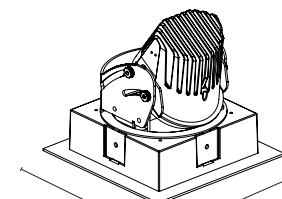

93.2mm (3.66")

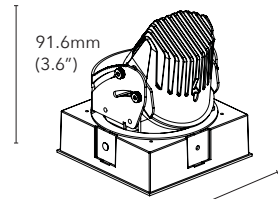

96.4mm (3.8")



Snap

They fit your light style.



# SORAA snap system™

ARC is universally compatible with the Soraa Snap System™, giving you total control to color and sculpt the perfect light.

Soraa Arc in 9°, 10°, and 15° beams are designed to work with the Soraa Snap System™ creating an optimized solution for luminaires and integrated lamp accessories.

Coupled with Soraa's high brightness single source LED technology, Soraa Snap System lighting effects are similar to halogen sources, with the added benefits of low operating temperature, ground-breaking optical design, and method of attachment.

The self-centering magnetic system is simple. Place a SNAP accessory directly on an Arc surface and the magnetic force will do the rest.

Soraa Snap System can be used in combination with other Soraa Arc accessories, They can be stacked (i.e. beam spreader and a CCT shifter) or when combining beam shaping Snaps with CCT shifters.

SNAP accessories are only compatible with Soraa Arc luminaires, Soraa lamps, and Optical Light Engines, in 9°, 10°, and 15° beam versions. See individual SNAP accessory data for exact diameters. IES files and photometric data for SNAP accessories are available at [www.soraa.com](http://www.soraa.com).

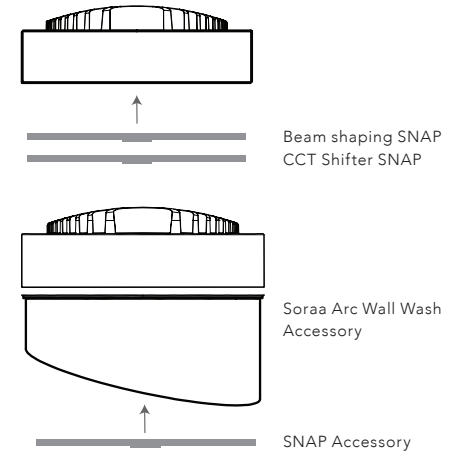

For best results always place CCT shifting Snap on the lamp first

## Clear

Use together with gel and dichroic filters for total color freedom. Produce the exact mood and effect you want for any environment. Sold in quantities of ten.

Diameter	Part Number	Product Code	Lumen Transmission (1 SNAP)	Lumen Transmission (2 SNAPS)	Thickness	Magnetic Attach Force
50mm	AC-CL-0000-00	02183	93%	87%	2mm	0.45 lb-F
84mm	AC-E-CL-0000-00	02185	93%	87%	3.1mm	

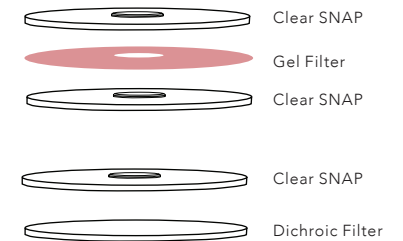
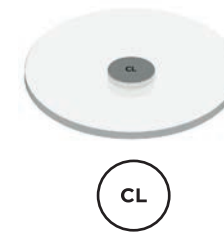

Suggested use with Gel or Dichroic filters

## Enhance

A color enhancing filter designed to modify the spectrum of Soraa VIVID luminaires and increase the vividness of warm colors (red, orange and pink) and greens. Use Enhance in applications where even richer, more vibrant color is desired.

Diameter	Part Number	Product Code	Lumen Transmission	Whiteness	Thickness	Magnetic Attach Force
50mm	AC-EN-0001-00	03281	75%	130%	2mm	0.45 lb-F
84mm	AC-E-EN-0001-00	03283	75%	130%	2mm	

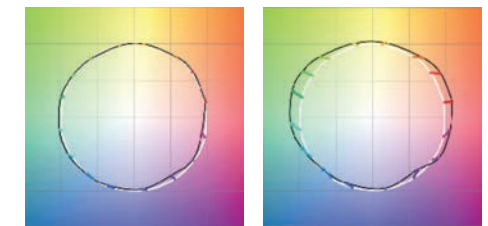
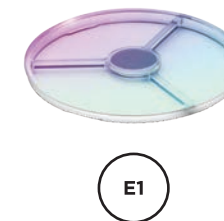

**Soraa Vivid (2700K & 3000K)**  
Rf:90, Rg:100,  
Rw (Whiteness): 120

**With Enhance SNAP**  
Rf:75, Rg:112  
Rw (Whiteness): 130

### Application Notes:

Use with CCTs of 3000K and 2700K.

Combine with either a Louver SNAP (for 10° spot applications) or with a Beam Spreader SNAP (for other beam angles)

Place Enhance as the first filter when stacking with other SNAP accessories.

# SORAA snap system™

## Beam Spreader

Use in any application where reducing the number of beam angle SKUs is required. Reduces inventory costs, shortens specification, design, and sales cycles. Provides maximum flexibility up to the time of installation.

Diameter	Beam	Part Number	Product Code	CBCP of 10°, 9° Beam	Field Angle	Lumen Transmission	Thickness	Magnetic Attach Force
50mm	17°	AC-GC-1717-00	03263	30%	33°	90%	2mm	0.45 lb-F
	25°	AC-GC-2525-00	00325	29%	40°			
	36°	AC-GC-3636-00	00327	14%	55°			
84mm	17°	AC-E-GC-1717-00	03265	53%	33°		3.1mm	
	25°	AC-E-GC-2525-00	01145	18%	40°			
	36°	AC-E-GC-3636-00	01147	8%	55°			
	60°	AC-E-GC-6060-00	01149	3%	90°			

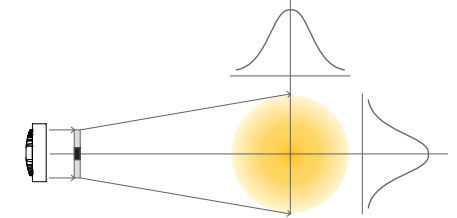
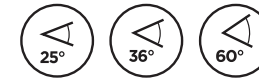

## Linear

Use in wall washes and illuminating asymmetric objects. Reduces required number of light fixtures and spill illumination of target objects.

Diameter	Beam	Part Number	Product Code	CBCP of 10°, 9° Beam	Field Angle Horiz/Vert	Lumen Transmission	Thickness	Magnetic Attach Force
50mm	10-25°	AC-GE-1025-00	00331	57%	27° / 35°	90%	2mm	0.45 lb-F
	10-36°	AC-GE-1036-00	00333	38%	27° / 43°			
	10-60°	AC-GE-1060-00	03259	25%	25° / 70°			
84mm	10-36°	AC-E-GE-1036-00	01595	30%	27° / 43°		3.1mm	
	10-60°	AC-E-GE-1060-00	03261	20%	20° / 70°			

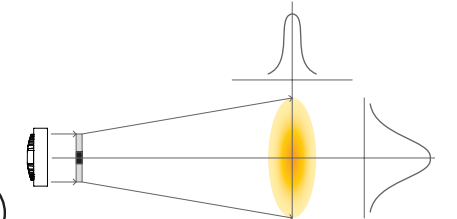

## Flat Top

Provides even illumination center to edge. Eliminates video camera saturation, for use in applications such as critical video surveillance.

Diameter	Beam	Part Number	Product Code	CBCP of 10° Beam	Field Angle Horiz/Vert	Lumen Transmission	Thickness	Magnetic Attach Force
50mm	25x25°	AC-FR-2525-00	00335	19%	44° / 44°	90%	2mm	0.45 lb-F
	36x36°	AC-FR-3636-00	00337	14%	46° / 46°			
84mm	36x36°	AC-E-FR-3636-00	01597	14%	46° / 46°			

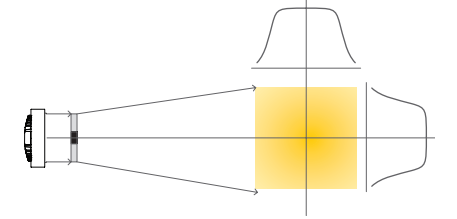
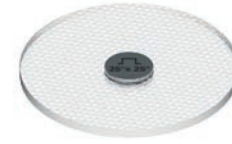

## Louver

Eliminates high angle glare, making light beams disappear in downlight applications. Reduces angular intensity to 0.1% of peak at 40° full angle. Fits around luminaire face. Can be used in combination with Sora Arc Accessories.

Diameter	Cutoff Angle	Part Number	Product Code	CBCP of 10° Beam	Thickness	Magnetic Attach Force
51.1mm	40°	AC-LU-4040-00	00339	63%	9mm	0.45 lb-F
84mm	40°	AC-E-LU-4040-00	01151	63%		

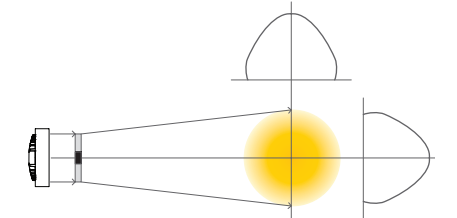

# SORAA snap system™

## Aim

Comprising two lenses, the Aim SNAP bends the beam from 0° to maximum deflection angle of 20° while maintaining uniform and consistent color and shape.

Diameter	Part Number	Product Code	Lumen Transmission	Beam	Maximum Deflection	Thickness	Magnetic Attach Force
50mm	AC-AM-0020-00	03255	85%	13°	20°	4mm	0.45 lb-F
84mm	AC-E-AM-0020-00	03257	85%	13°	20°	6.2mm	0.45 lb-F

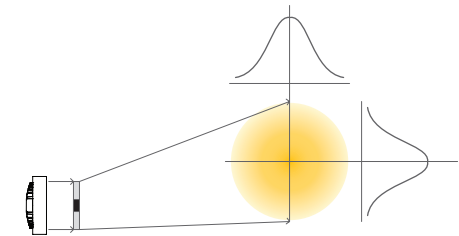

Stacked orientation lines will result in undesirable optical artifacts. Rotate one lens slightly to mitigate.



Wider angle between orientation lines produces less deflection.



Narrower angle between orientation lines produces more deflection.

**How Aim Works**  
Use the orientation lines to adjust beam deflection angle.

## CCT Shifter

Use in hospitality and restaurant applications to simulate warm dimming. Create custom colors for festive occasions or brand identity. A single luminaire SKU can be used for many different color temperatures.

Diameter	CTO	Part Number	Product Code	Lumen Transmission	Mired Shift	Thickness	Magnetic Attach Force
50mm	1/4	AC-CC-0001-00	00323	90%	37	2mm	0.45 lb-F
	1/2	AC-CC-0002-00	00321	75%	83		
	3/4	AC-CC-0003-00	00319	60%	120		
84mm	1/4	AC-E-CC-0001-00	01153	90%	37	3.1mm	0.45 lb-F
	1/2	AC-E-CC-0002-00	01155	75%	83		
	3/4	AC-E-CC-0002-00	01157	60%	120		



CTO  
1/4



CTO  
1/2

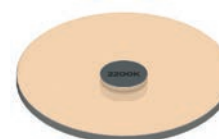

CTO  
3/4

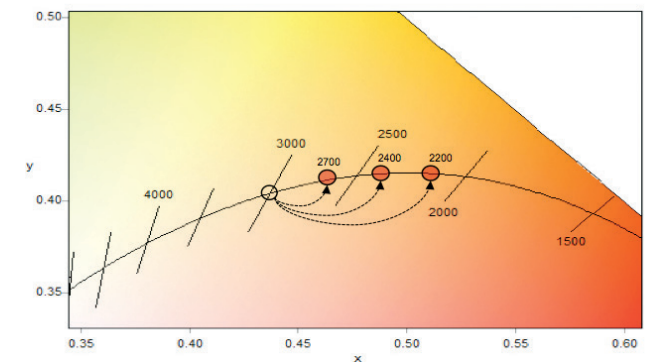

**CCT Shift Effect**

Starting CCT	1/4 CTO	1/2 CTO	3/4 CTO
2,700K	2,450K	2,200K	2,000K
3,000K	2,700K	2,400K	2,200K
4,000K	3,500K	3,000K	2,700K

# COLOR & WHITENESS

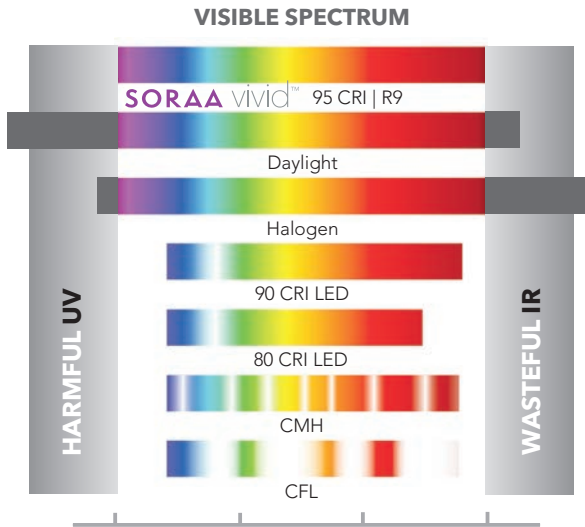

Soraa has engineered the perfect balance between color rendering and white rendering. Soraa's core technology uses a violet LED emitter as the basis for full spectrum light. This allows both Vivid™ color rendering and Natural White™ white rendering, which creates whiteness by exciting fluorescing agents with violet radiation, without the harmful effect of UV.

**Rf:** The TM-30 metric for color fidelity (similarity to colors under natural light), a more accurate version of the CRI Ra. Rf is 100 for natural light.

**Rg:** The TM-30 metric for color gamut (whether colors are more saturated than under natural light). Rg is 100 for natural light.

**Rfh1:** The TM-30 metric for color fidelity for red tones. Rfh1 is a more accurate version of the CRI R9. Rfh1 is 100 for natural light.

**Rw:** The Soraa-developed metric for white fidelity. Rw measures the magnitude of excitation of whitening agents within white materials. Rw is 100 for natural light.

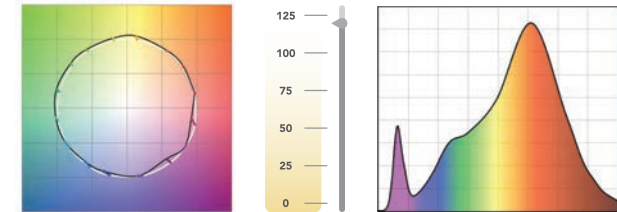

**Soraa Arc 2700K**

CRI	R9	Rf	Rg	Rfh1	Rw	McA
95	95	90	100	95	120	3

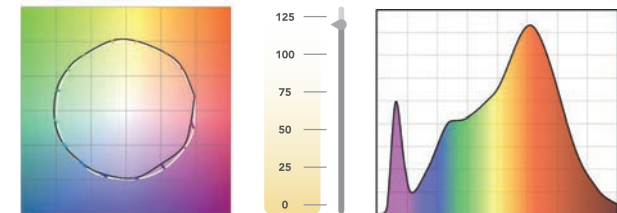

**Soraa Arc 3000K**

CRI	R9	Rf	Rg	Rfh1	Rw	McA
95	95	90	100	95	120	3

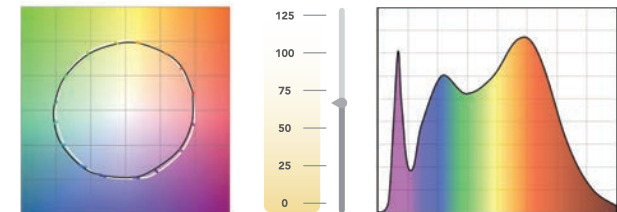

**Soraa Arc 4000K**

CRI	R9	Rf	Rg	Rfh1	Rw	McA
92	95	90	100	95	70	3

# SORAA arc™ | SPECIFICATIONS

## Soraa VIVID™ LED

Soraa Full Spectrum integral LED Light Engine available in 2700K, 3000K, and 4000K with 95 CRI, R<sub>w</sub> 100 (typical) and 95 R9. IR and UV free. 3-step McA SDCM.

## Soraa Optics

Soraa optic technology with exceptional beam control and smooth uniform light distribution. The 9°, 10°, and 15° beam versions are compatible with Soraa Snap System.

## Construction and Finish

Light engine is made of die cast aluminium, transformer case from extruded aluminum. Durable satin finish. Custom colors available.

## Electrical

120VAC or 220-240VAC fully integral LED electronic constant current driver (included).

Frequency: 50/60Hz

Power Factor: 0.93

Wattage: 11W, 18W, 20W

## Dimming and Flicker

Dimmable to <1%

Percent Flicker: < 30%

Triac and ELV dimming standard

Refer to website for details

## Applications

Suitable for damp or dry locations. For interior use only.

## Accessories

ARC fixtures are compatible with Soraa Arc accessories and Soraa Snap System simultaneously.\*

\*Excludes Wall Wash Downlight

## Compliance

cULus Listed. FCC CFR Title 47 Part 15 Class B compliant. CE Compliant.

## Warranty

Five year warranty. Consult [www.soraa.com](http://www.soraa.com).

## Operating Temperature

Minimum -40° C, 25° C typical.



## Soraa Arc Photometrics

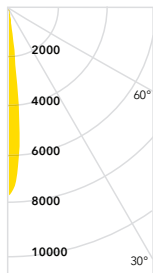

50mm  
Narrow Spot  
10°

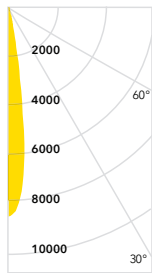

50mm  
Spot  
15°

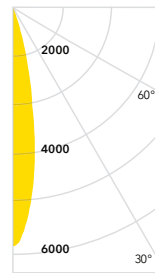

50mm  
Narrow Flood  
25°

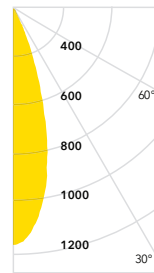

50mm  
Flood  
36°

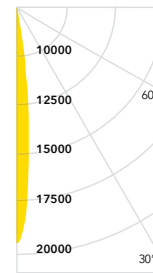

100mm  
Narrow Spot  
9°

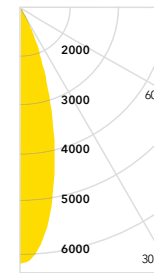

100mm  
Narrow Flood  
25°

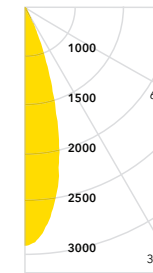

100mm  
Flood  
36°

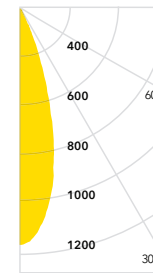

100mm  
Wide Flood  
60°

SIMPLY PERFECT LIGHT.™

SORAA®



#### SORAA CORPORATE HEADQUARTERS

6500 Kaiser Dr. Suite 110  
Fremont, CA 94555  
+1 855 467-6722

#### SORAA INTERNATIONAL

Unit 38, Ambition Broxbourne Business Centre  
Pindar Road  
Hoddesdon  
EN11 0FJ  
United Kingdom  
+44 (0)1992 535053

#### JAPAN

3-22-4-203 Funado  
Itabashi-ku  
Tokyo, 174-0041  
Japan  
+81 (0)3 5948 7440

#### GENERAL INFO

[info@soraa.com](mailto:info@soraa.com)  
[international@soraa.com](mailto:international@soraa.com)  
[japan@soraa.com](mailto:japan@soraa.com)  
[techsupport@soraa.com](mailto:techsupport@soraa.com)



**SORAA** arc™

visit us: [www.soraa.com](http://www.soraa.com)

follow us:   